

Lusac®

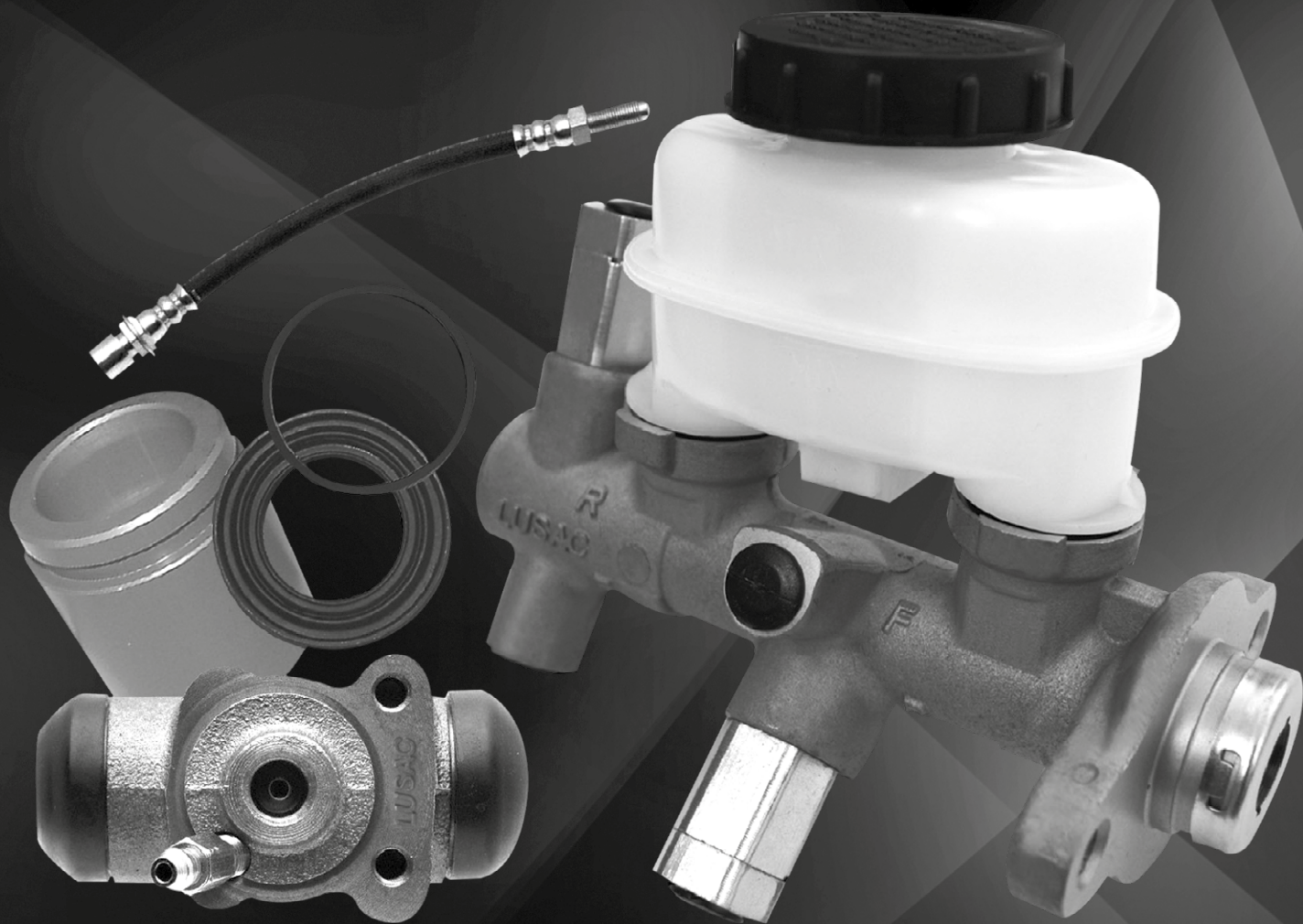

Catálogo Hidráulico



Índice

Como usar este catálogo	3
BUYERS GUIDE	5
Catálogo por número de parte	87
Imágenes por número de parte	293
Medidas y especificaciones	565
Información técnica	589

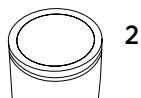



Como usar este catálogo

PASO 1: TABLA DE APLICACIONES POR LÍNEA DE PRODUCTO

En la "TABLA DE APLICACIONES ESPECÍFICAS POR LÍNEA DE PRODUCTO" de las páginas 11 a 140 puede ubicar las aplicaciones de las siguientes partes de frenos, en este caso del Chevrolet, Cavalier, 1999

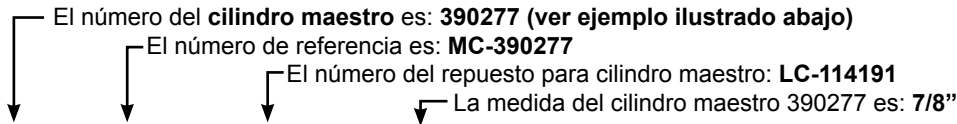

CILINDROS MAESTROS					
NÚMERO DE PARTE	NÚMERO CIL. MTRO. RAYBESTOS	NÚMERO REPUESTO LUSAC	MEDIDA	APLICACIÓN	FOTO PÁGINA
390277	MC-390277	114191	7/8	Chevrolet Cavalier 95-99, Cavalier Z24 95-96, Sunfire 97-99	403

PASO 2: FOTOGRAFÍAS DE PRODUCTO

En la "TABLA DE APLICACIONES ESPECÍFICAS POR LÍNEA DE PRODUCTO" puede encontrar el número de página de la fotografía del producto que busca, en este caso del Chevrolet, Cavalier, 1999 (este CATÁLOGO MÁSTER DE FRENOS cuenta con fotografías de cilindros maestros, cilindros de embrague, cilindros de rueda, mangueras para frenos, pistones freno de disco, repuestos de cilindro maestro, respuestos freno de disco, rotores y tambores):

En la "TABLA DE APLICACIONES ESPECÍFICAS POR LÍNEA DE PRODUCTO" de las páginas ¿? Puede ubicar las aplicaciones de las siguientes partes de frenos, en este caso del Chevrolet, Chevy 2003:

Modelo	Versión	Año	Descripción	Número Lusac	Posición	Notas	Foto Pág.
CHEVROLET							
CHEVY	JOY, SWING	94-03	CILINDRO MAESTRO	390801RL		20.6mm	64

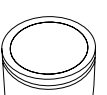



GLOSARIO

ABREVI./SIGNO	SIGNIFICADO
DEL	Delantero
TRAS	Trasero
DS	Disco
T	Tambor
I	Izquierdo
D	Derecho
N.D.	No Disponible
N.R.	No requiere
BH	Brake Hose (Manguera para freno)
LC	Lusac
MC	Master Cylinder (Cilindro Maestro)
WC	Wheel cylinder (Cilindro de Rueda)
WK	Wheel Kit (Repuesto freno de disco y repuesto freno de tambor)
-----	Diámetro no especificado
(*)	Números identificados
DS	Disco sólido
DV	Disco ventilado
RS	Rotor sólido
RV	Rotor ventilado

NOTA: En el caso de mangueras para frenos, cuando encuentre una línea punteada “-----” significa que solamente lleva una sola manguera, ejemplo

I LC-381475
D -----

LÍNEA DE PRODUCTO	PRODUCTOS A LA VENTA	NÚMEROS IDENTIFICADOS
Cilindros maestros	LC	MC
Cilindros de rueda	LC	(*)
Cubre polvos	LC	(*)
Gomas para frenos	LC	(*)
Mangueras para frenos	LC	(*)
Pistones cilindro de rueda	LC	(*)
Pistones para freno de disco	LC	(*)
Repuestos para cilindro maestro	LC	(*)
Repuestos para cilindro de rueda	LC	(*)
Repuestos freno de disco	LC	WK
Rotores		(*)
Purgadores	LC	(*)
Tambores		(*)

NOTA: En cilindros maestros puede aparecer el número solo o con las iniciales LC.

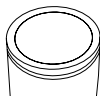

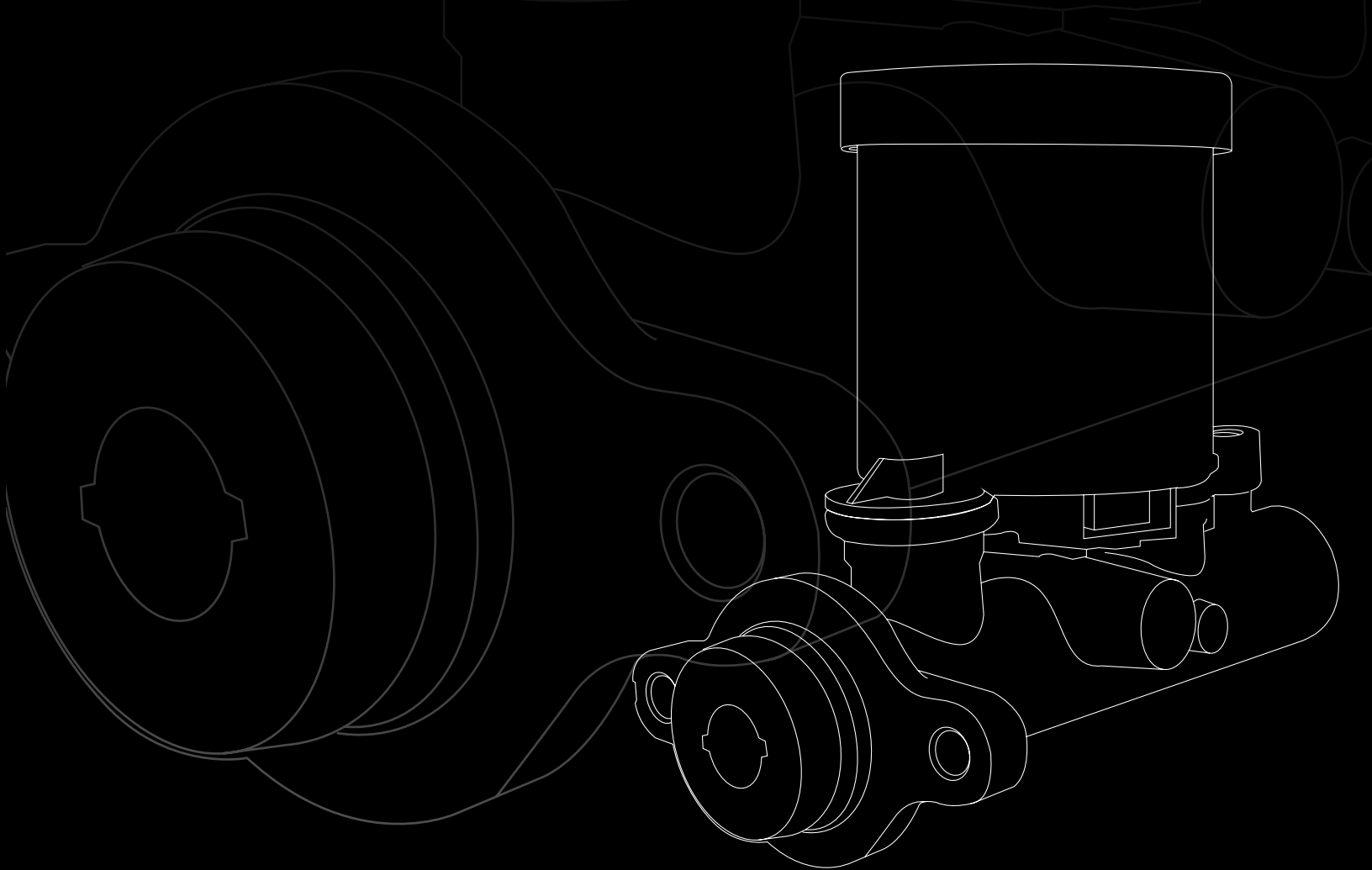

Lusac[®]



BUYERS GUIDE





CILINDRO DE CLUTCH			
No. PARTE LUSAC	No. PARTE RAYBESTOS	DIAMETRO	APLICACIÓN
6600	SC37493	19.0 mm 3/4"	Nissan Cil. Esclavo de Clutch Datsun Sedan 70-83, Samurai 70-84, Nissan Urvan 02-06 Nacional, Pick Up 720 80-86, Nissan Pick Up D21 86 USA
33720	SC33721	25.4 mm 1"	Ford Cil. Clutch Esclavo F-100, 57-65, F- 250 57-68, F- 300, 57-64, P-400 57-77, Camion 57-76
37365	SC37365	19.0 mm 3/4"	Toyota Celica 74, Toyota Corona 74-77, Toyota Pickup 75-80 USA
37493	SC37493	19.0 mm 3/4"	Nissan 240SX 91-98, Nissan 240Z 73, Nissan 260Z 74, Nissan 280Z 75-79, Nissan 280ZX 79-83, Nissan 610 73-76, Nissan 710 74-77, Nissan B210 76, Nissan Maxima 77-84, USA
37498	SC37498	19.0 mm 3/4"	Nissan 620 72-79, Nissan pickup 2WD 80-10/85 USA
37525	SC37525	20.6 mm 13/16"	Toyota Corona 78, Toyota 4Runner 3.0L (31470-35100) 88-10/95, Toyota Pickup 3.0L (31470-35100) 80-95, Toyota T100 3.0L (31470-35100) 93-94, Toyota Van AWD 89-90, USA
37627	SC37627	19.0 mm 3/4"	Nissan 300ZX 84-96, Nissan Frontier Pickup 98, Nissan Pathfinder 96-98 USA
37680	SC37680	17.4 mm 11/16"	Nissan D21 86-97 Cilindro Esclavo Aluminio
37681	SC37681	17.4 mm 11/16"	Nissan 200SX 87-88, Nissan Pick Up D21 86-97, Nissan Pathfinder 87-95 USA
37699	SC37699	20.6 mm 13/16"	Toyota Paseo 92-95, Toyota Tercel 87-95 USA
37701	SC37701	20.6 mm 13/16"	Chevrolet Nova 85-88 Nacional, Toyota Corolla 84-88 USA
37725	SC37725	22.2 mm 7/8"	Ford Bronco II 84, Ford Ranger 83-84 USA
37728	SC37728	20.5 mm	Chevrolet Blazer 83-91, S10 Pickup 84-91, T10 Pickup 84-91, Sonoma 84-91 USA, GMC T15 Jimmy 84-91, T15 84-91 USA, Oldsmobile Bravada 91-92 USA
37745	SC37745	31.7 mm 1-1/4"	Ford Cilindro Esclavo de Embrague F-450 88-97, F-200, 250 83-94, F-300, 350 83-91
37790	SC37790	20.6 mm 13/16"	Chevrolet Astro Mini Van 85-89, Safari Mini Van 85-89 USA
37791	SC37791	20.6 mm 13/16"	Chevrolet C-10, C-20, C-30 85-91, Clutch secundario
37793	SC37793	22.2 mm 7/8"	Jeep Cherokee 84-86, Jeep CJ Series 82-86, Jeep Comanche 86, Jeep Wagoneer 84-86, Eagle 81-84 USA
37815	SC37815	20.6 mm 13/16"	Chevrolet C10, C15 Pickup 88-91, GM C20, C25 Pickup 88-91, GM C30, C3588-91 Nacional, Chevrolet GM K10, K15 Pickup 88-91, GM K20 Suburban 88-91, GM K20, K25 Pickup 88-91, GM K30, K35 88-91, GM R10 Suburban 88, GM R15 Suburban 89-91, GM V20 88. USA
37816	SC37816	20.6 mm 13/16"	Chevrolet T10 Blazer 90-91, S10 Pickup 90-91, T10 Pickup 90-91, Sonoma 90-91, USA, GMC T15 Jimmy 90-91, T15 90-91 USA, Oldsmobile Bravada 91 USA
37833	SC37833	22.2 mm 7/8"	Chevrolet Luv 97-05 Nacional, Isuzu Amigo 89-01, Isuzu Pickup 88-95, Isuzu Rodeo 91-01, Isuzu Trooper II 88-91 USA
37834	SC37834	22.2 mm 7/8"	Isuzu Pickup 91-94, Isuzu Rodeo 91-92, Isuzu Trooper II 89-91 USA
37837	SC37837	19.0 mm 3/4"	Mazda B2000 86-87, Mazda B2200 86-93 USA
37889	SC37889	19.0 mm 3/4"	Honda Accord 90-97 Nacional, Acura 2.2 CL 97, Acura 2.3 CL 98-01 USA, Honda Prelude 92-01, Honda Passport 01-02 USA
37897	SC37897	N/R	Ford Collarín Cougar 89-96, Aeroestar 91-92, Explorer 91-92, F-100, 150, 200, 250 88-92 Nacional, Ford Collarín Bronco 88-92, Bronco II 88-90, E-100, 150, 200, 250, 88-89, E-300, 350 88-95, Ranger 88-92 USA
37900	SC37900	19.0 mm 3/4"	Ford Escort 91-96 Salida Trasera Nacional, Ford Mercury Tracer 91-96 USA, Kia Sephia 94-97 USA, Mazda Protege 90-95 USA
37901	SC37901	19.0 mm 3/4"	Ford Escort 91-96 Salida Lateral Nacional, Ford Mercury Tracer 91-96 USA
37915	SC37915	N/R	Jeep Cherokee 87-91, Jeep Comanche 87-91, Jeep Wagoneer 87-90, Jeep Wrangler 87-94 USA
39072	CMA39072	15.8 mm 5/8"	Nissan 510 1.6L 3/69-73, Nissan 610 1.8L & 2.0L 72-10/75, Nissan 710 74-10/75 USA
39102	CMA39102	15.8 mm 5/8"	Nissan 280Z 2.8L (30610.N4200) 4/75-78, Nissan 510 2.0L 72-81, Nissan 610 2.0L 11/75-76, Nissan 710 11/75-77, Nissan 810 97-80. USA
39179	CMA39179	15.8 mm 5/8"	Toyota Cressida 83-87, Toyota Pickup 79-83 USA
39239	CMA39239	15.8 mm 5/8"	Nissan Maxima 7/84-88, Nissan Stanza 1/86-89, Nissan 200SX 80-81, Nissan 210 78-82, Nissan 240SX 89-99, Nissan 240Z 70-73, Nissan 260Z 74-3/75 USA
39569	CMA39569	22.2 mm 7/8"	Ford E150 84-87, Ford E250 84-89, Ford E350 88-89 USA
39588	CMA39588	15.8 mm 5/8"	Toyota Pickup 81-85 USA
39605	CMA39605	15.8 mm 5/8"	Nissan D21 (30610.59G11) 11/85-97 Nacional, Nissan Pathfinder (30610.59G11) 87-95 USA
39613	CMA39613	15.8 mm 5/8"	Toyota Celica 86-89, Toyota Corolla Coupe y Coupe GTS 84-87 USA
39645	CMA39645	17.8 mm 45/64"	Jeep Cherokee 87-90, Jeep Wagoneer 87-90, Jeep Comanche. 87-90 USA
39681	CMA39681	15.8 mm 5/8"	Toyota Tercel (31420.10013) 87-5/89 USA
39715	CMA39715	17.8 mm 45/64"	Chevrolet Oldsmobile Bravada 91, S & T10 Blazer 84-91, S & T10 Pickup 90-91, S & T15 Jimmy, 84-91 S & T15 Sonoma 84-91 USA
39723	CMA39723	19.0 mm 3/4"	Jeep Cherokee 4Cil. 2.5L 83-86, Jeep Sportwagon 84 Jeep Wagoneer 84-86 USA
39731	CMA39731	19.0 mm 3/4"	Chevrolet Astro Mini Van 85-89, Safari Mini Van 85-89 USA

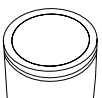



CILINDRO DE CLUTCH			
No. PARTE LUSAC	No. PARTE RAYBESTOS	DIAMETRO	APLICACIÓN
39732	CMA39732	17.8 mm 45/64"	Chevrolet Blazer 84-90, GM Series C y K 85-86, Series R y V 85-91. Series G(15615867) 85-87 USA
39738	CMA39738	17.8 mm 45/64"	Chrysler Jeep Cherokee 6 Cil. 2.8L (53001163) 84-86, Jeep Comanche 84-86, Jeep Wagoneer 84-86 USA
39794	CMA39794	15.8 mm 5/8"	Isuzu Trooper II con Discos Tras. (8-94315559-3) 88-91 USA
39802	CMA39802	15.8 mm 5/8"	Ford Probe Turbo y no Turbo 2.2L sin ABS 89-92, Probe 3.0L sin ABS 90-92USA, Mazda 626 sin ABS 88, Mazda MX6 sin ABS 88-89. USA
39803	CMA39803	15.8 mm 5/8"	Ford Probe 2.2L Turbo con ABS 89-90, Probe 3.0L Turbo y no Turbo con ABS90-92 USA, Mazda 626 turbo con ABS 88-92. USA
39804	CMA39804	15.8 mm 5/8"	Chevrolet Luv 97-05 Nacional, Honda Passport 94-97, Isuzu Amigo 89-95, Isuzu Pickup 88-95, Isuzu Rodeo 91-97, Isuzu Trooper 92-97. USA
39813	CMA39813	17.4 mm 11/16"	Chevrolet Cilindro Maestro de Embrague Superior C-10 90-91, C-20,25 C-30,35090-91
39820	CMA39820	15.8 mm 5/8"	Ford Cilindro Maestro de Embrague Escort 91-96
39836	CMA39836	15.8 mm 5/8"	Acura 2.2 CL 97, Acura 2.3 CL 98-99 USA, Honda Accord 90-97, Honda Prelude 92-00 USA
39894	CMA39894	22.2 mm 7/8"	Ford Cilindro Maestro de Embrague Superior F-100, 150, 200, 250, 300, 350 88-91 Nacional, Ford Cilindro Maestro de Embrague Superior Bronco 88-91, E-300, 350 USA
39896	CMA39896	22.2 mm 7/8"	Ford Aerostar 88-90, Ford Bronco II 88-90, Ford Trk. Ranger 88-91 USA
39903	CMA39903	15.8 mm 5/8"	Honda Civic 92-00 Nacional, Honda Del Sol 93-97 USA
39904	CMA39904	19.0 mm 3/4"	Chrysler Dodge Neon 97-99, Ford Explorer 91, Ford Ranger 90-91 Nacional, Mazda Navajo 91-92 USA
39913	CMA39913	15.8 mm 5/8"	Mazda Motor 2.2 L y 2.6 L Pick-up B 2000 86-87, B 2200 86-93, B 2600 87-93USA
39934	CMA39934	15.8 mm 5/8"	Toyota Tacoma 95-02, Toyota T100 93-98 USA
43233	SC36164	25.4 mm 1"	Dina Cil. Esclavo Camion 1966-89 Ford 600,700 800 1961-85
43307	SC33723	25.4 mm 1"	Chrysler Cil. Clutch Esclavo Dodge D-100, D-200, D-300, 57-69,Cmon.Varios 59-77
54699	CMA36153	25.4 mm 1"	Dina Bomba de Clutch Sup. Cmon. 66-89, Inter.Cmon 71-80
103483	SC37791	20.6 mm 13/16"	Chevrolet Cil. Mtro. de Embrague Cmta.C-10,C-20,C-30 85-91, Clutch Secundario
103485	SC37723	25.4 mm 1"	Ford F-150, 250, 350 84-87 Cil. Emb. Esclavo Nacional, Ford Bronco 84-87USA Cil. Emb. Esclavo
110270	CMA39573	19.0 mm 3/4"	Ford Aerostar 86-87, Bronco II 84-87, Ranger 83-87 USA
110273	732 66-2	17.4 mm 11/16"	Chevrolet Cil. Mtro de Embrague Cmta C-10, C-20, C-30, 85-91 Superior
110710	CMA39560	22.2 mm 7/8"	Ford F-150, 250 y 350 84-87 Cil.Mtro.Emb.Nacional, Ford Bronco 84-87 USACil. Mtro.Emb.
300319	N/D	38.1 mm 1-1/2"	Cilindro Esclavo de Embrague Inferior Mercedes Benz Om-366 O-371
300335	N/D	23.8 mm 15/16"	Cilindro Esclavo de Embrague Superior Mercedes Benz Om-366 O-371, Sprinter04-05
350004	CMA350004	15.8 mm 5/8"	Toyota 4 Runner 89-95, Pickup 89-95 USA
350009	CMA350009	15.8 mm 5/8"	Toyota 4 Runner 89-95, Toyota Pickup 89-95 USA
350014	CMA350014	19.0 mm 3/4"	Chevrolet Camaro, Z28 95-02, Firebird, Trans Am 94-01
350021	CMA350021	22.2 mm 7/8"	Chrysler Dodge Dakota 87-94 USA
350032	CMA350032	18.0 mm	Ford Cilindro Esclavo de Embrague Superior F-150 93-95, F-200, F-250 93-97 F-300, F-350 92-97 Nacional, Ford Cilindro Esclavo de Embrague Superior Bronco 93-98 USA
350033	CMA350033	22.2 mm 7/8"	Ford Cilindro Esclavo de Embrague Superior F-100,F-150, 92, F-200, F-25092,F-300, F-350 92 Nacional, Ford Cilindro Esclavo de Embrague Superior Bronco 92 USA
350034	CMA350034	19.09 mm	Ford Aerostar 92
350037	CMA350037	19.0 mm 3/4"	Ford Ranger 92 USA
350041	CMA350041	19.0 mm 3/4"	Ford Aerostar 91 Nacional, Ford Bronco II 88-90 Ford Ranger 88-91 USA, Mazda Navajo 91 USA
350042	CMA350042	17.7 mm	Chevrolet Cilindro Esclavo de Embrague Superior G.M. Blazer 92-95, Chev. C-10,C-15 92-95, C-20, C-25, C-30,C-35 92-95, Silverado 92-93
350044	CMA350044	22.2 mm 7/8"	Chrysler Cilindro Esclavo de Embrague Superior Dodge D-100,150, 200, 250,300, 350 88-91
350055	CMA350055	15.8 mm 5/8"	Ford Explorer 93-94 Nacional, Ford Ranger 93-94 USA, Mazda B2300 94,Mazda B3000 94, Mazda B4000 94, Mazda Navajo 93-94 USA
350058	CMA350058	22.2 mm 7/8"	Chrysler Cilindro Esclavo de Embrague Superior Ram 1500 94-97, Ram 2500 94-97, Ram 3500 94-97
350071	CMA350071	19.0 mm 3/4"	Volkswagen Passat 95-97Nacional, Volkswagen Corrado 94 USA
350081	CMA350081	15.8 mm 5/8"	Nissan Maxima 95-00, Infiniti I30 95-01
350082	CMA350082	15.8 mm 5/8"	Nissan 240SX 95-98 USA
350087	CMA350087	15.8 mm 5/8"	Chrysler Dodge Sebring 97 Nacional, Chrysler Avenger 95-99, Eagle Talon 95-99 USA, Eagle Talon 95-99 USA, Mitsubishi Eclipse 95-99 USA
350092	CMA350092	15.8 mm 5/8"	Nissan pick Up D21 96-97

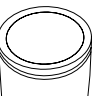



CILINDRO DE CLUTCH			
No. PARTE LUSAC	No. PARTE RAYBESTOS	DIAMETRO	APLICACIÓN
350093	CMA350093	15.8 mm 5/8"	Nissan Pathfinder 97-00
350104	CMA350104	18.0 mm	Jeep Cherokee 97-01 Nacional, Jeep Wrangler 97-01 USA
350110	CMA350110	18.0 mm	Honda Accord 98-01
350112	CMA350112	18.0 mm	Chrysler Ram 1500 98-01, Ram 2500 98-01, Ram 3500 98-01
350123	CMA350123	15.8 mm 5/8"	Honda Passport 98-00 USA, Isuzu Amigo 98-01, Isuzu Rodeo 98-01 USA
350182	CMA350182	18.0 mm	Chevrolet. C10 Suburban 94-98, C10, C15 Pickup 94-95, C20 Suburban; 92-95, C20, C25 Pickup 94-95, 30, C35 94-95 Nacional, Chevrolet. K10 Suburban 94-95, K10, K15 Pickup 94-95 USA
360000	SC360000	31.7 mm 1-1/4"	Chevrolet Cilindro Esclavo de Embrague Inferior Cavalier 90-92
360002	SC360002	31.7 mm 1-1/4"	Chevrolet Cilindro Esclavo de Embrague Inferior Celebrity 85-91, Century 85-91, Cutlass 85-91, Citation 85-91
360005	SC360005	21.0 mm 53/64"	Chevrolet Cilindro Esclavo de Embrague Inferior Blazer 92-93 USA, Oldmobile Cilindro Esclavo de Embrague Inferior Bravada 92-94 USA
360014	SC360014	21.0 mm 53/64"	Ford Cilindro Esclavo de Embrague Inferior F-100, 150, 93-95, F-200, 250, 93-95, F-300, 350 93-95
360016	SC360016	N/R	Ford camioneta Aerostar 93-95, Explorer 93-01, F-150 93-04, F-200/250 93-01, F-300/350 93-98 Nacional, Ford Bronco 93-96, Ranger 93-04 USA, Mazda Camionetas B2300 94-97, B-2500 98-99, B-3000 94-99, B-4000 94-99, Navajo 93-94 USA
360025	SC360025	19.0 mm 3/4"	Honda CR-V 98-01, Honda Civic 92-00 Nacional, Acura Integra 94-00; USA, Honda Honda Del Sol 93-97 USA
360027	SC360027	20.0 mm	Chevrolet Cilindro Esclavo de Embrague Inferior C-20, 25 92-95, Silverado 92-93
360033	SC360033	22.2 mm 7/8"	Honda Passport 94-00 USA, Isuzu Amigo 98-99, Isuzu Rodeo 93-01, Isuzu Trooper 92-02 USA
360046	SC360046	25.4 mm 1"	Chrysler Cilindro Esclavo de Embrague Inferior Chrys. Dodge B, D-100, 150, 92-93, Dm-350 88-91, E-250 92-93, Ram Charger 92-93
360055	SC360055	20.6 mm 13/16"	Toyota Tacoma 95-04, Toyota 4 Runner 96-01, Toyota T100 95-98, Toyota Tundra 00-04 USA
360084	SC360084	17.4 mm 11/16"	Chrysler Dodge Dakota 97-01 USA
360085	SC360085	21.0 mm 53/64"	Chrysler Dodge Ram 1500 98-01, Ram 2500 98-01, Ram 3500 98-01
360089	SC360089	Concentrico	Jeep Cherokee 92, Jeep Wrangler 92 USA
360107	SC360107	Concentrico	Chevrolet Silverado 1500 y Heavy Duty 01-02, Silverado 3500 Heavy Duty 01-02 Nacional, Chevrolet Sierra 3500 Heavy Duty 01 02, Sierra 1/2 Ton 01, Sierra 1/2 Ton Heavy Duty 01-02, Sierra 3/4 Ton 01-02, Sierra 3/4 Ton Heavy Duty 01-03 USA
360108	SC360108	21.0 mm 53/64"	Ford F250 Super Duty 99-05, Ford F350 98-05, Super Duty Ford F450 SuperDuty 99-01, Ford F550 Super Duty 99-01
360109	SC360109	21.0 mm	Ford F250 Super Duty 99-05, Ford F350 Super Duty 98-05, Ford F450 SuperDuty 99-04, Ford F550 Super Duty 99-04
360111	SC360111	N.R.	Chevrolet Cavalier 00-05, HHR 08, Sunfire 02 Nacional, Chevrolet Cobalt 08, Grand Am 02-04, Alero 02-04 USA, Saturn Vue 02-05 USA
360125	SC360125	19.0 mm 3/4"	Honda Accord 03-06, Honda CR-V 02-04 Nacional, Acura RSX 02-05, Acura TSX 04-05 USA, Honda Element 03-08 USA
360128	SC360128	N.R.	Chevrolet Blazer 03-05 Nacional, Chevrolet Sonoma 03 USA, GMC Jimmy 03-04, T10 Pickup 03-04, T15 03 USA
360139	SC360139	17.4 mm 11/16"	Nissan Altima 05-06, Nissan Maxima 04-06
519868	N/D	15.8 mm 5/8"	Chrysler Dodge Stratus 01-02 Nacional, Chrysler Sebring 01-02 USA, Mitsubishi Eclipse 01-02 USA
31470302	SC37606	20.6 mm 13/16"	Toyota Cressida 81-87, P-UP 86-87 USA
306108J1		15.8 mm 5/8"	Nissan Altima 01-02
306109Z4	CMA350119	15.8 mm 5/8"	Nissan Xterra 00-02, Nissan Frontier 4 cil Oct 98-01, Nissan Frontier 6 Cil Oct 99-01.
30610C07		15.8 mm 5/8"	Nissan Ichi Van 620, 810 Todos USA
3062003W	SC37627	19.0 mm 3/4"	Nissan 610 73-76, 710 74-77, Maxima 77-84 USA
3062056E	SC37928	17.4 mm 11/16"	Nissan Altima 93-00, Maxima 89-94, Pulsar 88-89, Stanza 88-92, Axxess 90-92(USA), Nissan Altima 96-00, Maxima 91-94 (Nacionales).

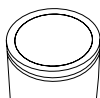



CILINDRO DE RUEDA			
No. PARTE LUSAC	No. PARTE RAYBESTOS	DIAMETRO	APLICACIÓN
746	WC37317	38.1 mm 1-1/2"	Chrysler Dodge Camion 500, 600 58-67
834		19.0 mm 3/4"	Chevrolet Tras. Izq. Der. Chevy Joy, Swing 96-03, Monza 97-03, Chevy Pop 94-03, Chevy Vagoneta 00 -03, Corsa 02-08, Corsa Sedan 03-08, Astra 00-03 1.8L, Meriva 04-07, Spark 11-12, Tigra 99, Zafira 02-06
844		19.0 mm 3/4"	Chevrolet Chevy C2, 2 puertas 04-10, Chevy C2 Sedan 4 puertas 05 - 07, Chevrolet Tras. Izq. Der. Chevy Joy, Swing 94-03, Monza 97-03, Chevy Pop 96- 03, Chevy Vagoneta 00 -03,
1012	WC1012	44.4 mm 1-3/4"	Chrysler Del. Izq. Der. Camión 3, 4 y 5 Toneladas 48-57
3406	WC3406	31.7 mm 1-1/4"	Chevrolet Del. Izq. Der. Camion 40 36-50, 60 47-50
3731	WC3731	31.7 mm 1-1/4"	Chevrolet Del. Izq. Camion Pasajeros 36-48
4419	WC4419	34.9 mm 1-3/8"	Chevrolet Del. Der. Camion 47-49
4511	WC4511	38.1 mm 1-1/2"	Ford Tras. Izq. Der. F-300, 350 48-49, F- 500-600 40-52
7379	WC7379	25.4 mm 1"	VAM Del. Izq. Jeep Willys 42-53
8852	WC8852	28.5 mm 1-1/8"	Chevrolet Del. Izq. C-50 70-72, C-60 70-88, C-65 79-85.
8853	WC8853	28.5 mm 1-1/8"	Chevrolet Del. Der. C-50 70-72, C-60 70-88, C-65 79-85.
9090	WC9090	26.9 mm 1-1/16"	Ford Del. Izq. F-100 70-71.
9091	WC9091	26.9 mm 1-1/16"	Ford Del. Der. F-100 70-71.
9337	WC7564	25.4 mm 1"	Chevrolet Tras. Der. Camioneta. G-35 1971 USA.
9344	WC9344	31.7 mm 1-1/4"	Chevrolet Tras. Izq. C-30, 35 70., Chrysler D-300 70-71, Chrysler Tras. Izq D-300 70-71
9345	WC9345	31.7 mm 1-1/4"	Chevrolet Tras. Der. C-30, 35 70., Chrysler D-300 70-71, Chrysler Tras. Der. D-300 70-71
10028	WC10028	20.6 mm 13/16"	VAM Tras. Izq. Der. Jeep Willys 61-64
10580	WC10580	28.5 mm 1-1/8"	Chrysler Del. Izq. Dodge Camioneta. D-100 , 150, 200 y 250 48-53
10581	WC10581	28.5 mm 1-1/8"	Chrysler Del. Der. Dodge Camioneta. D-100 , 150, 200 y 250 48-53
10582	WC10582	28.5 mm 1-1/8"	Chrysler Del. Izq. Dodge Camioneta. D-100, 150 57-58
10583	WC10583	28.5 mm 1-1/8"	Chrysler Del. Der. Dodge Camioneta. D-100, 150 57-58
10588	WC10588	28.5 mm 1-1/8"	Chrysler Tras. Der. Dodge Camion Modelo Early 46-56
13369	WC13369	26.9 mm 1-1/16"	Chrysler Dodge D-500 72-77, D- 600 70-77, Del. Der.
13387	WC13387	25.4 mm 1"	Chevrolet Tras. Izq. C-10 70-73, C-30, C-35 71-73, VAM Tras. Izq. Wagoneer J-164 70-73
13388	WC13388	25.4 mm 1"	Chevrolet Tras. Der.. C-10 70-73, C-30, C-35 71-73, VAM Tras. Der. Wagoneer J-164 70-73
14069	WC14069	25.4 mm 1"	VAM Tras. Der. Ambassador 65-70, Classic 65-66, Jeep Willys 50-64
14493	WC14493	28.5 mm 1-1/8"	Chevrolet Del. Izq. C-10 51-54, C-20 65-69, C-30 55,
14494	WC14494	28.5 mm 1-1/8"	Chevrolet Del. Der. C-10 51-54, C-20 65-69, C-30 55,
15306	WC15306	34.9 mm 1-3/8"	I.H.C. Tras. Izq- Der. Camion Serie 140 58-62
15307	WC15307	38.1 mm 1-1/2"	I.H.C. Tras- Izq. Camion Serie 160 62-82
15315	WC15315	38.1 mm 1-1/2"	Chevrolet Del. Der. G.M.C. Camion 400 50-54
16534	WC16534	25.4 mm 1"	VAM Del. Jeep Willis 50-64
16535	WC16535	19.0 mm 3/4"	VAM Tras. Der. Jeep Willis 53-65
17507	WC17507	22.2 mm 7/8"	Grand Cherokee 93-98, W-250 4X4 86-93, Ram Van 3500 95-97, Ram Wagon 3500 95-97, Ford Tras Izq. Falcon 8 Cil 63-70, Maverick 74-77, Mustang 71-73 ,F-100 70-79, Vam Tras Izq. Vam American 70 y 74-83, Classic 74-76, Gremlin 77-83, Javelin 70, Pacer 76-78, Rally 71-76, Jeep CJ-5 76-86, Jeep CJ-7 82-84, Wagoneer 84-86
17508	WC17508	22.2 mm 7/8"	Grand Cherokee 93-98, W-250 4X4 86-93, Ram Van 3500 96-97, Ram Wagon 3500 96-97, Ford Tras Der. Falcon 8 Cil 63-70, Maverick 74-77, Mustang 71-73 ,F-100 70-79, Vam Tras Der. Vam American 70 y 74-83, Classic 74-76, Gremlin 77-83, Javelin 70, Pacer 76-78, Rally 71-76, Jeep CJ-5 76-86, Jeep CJ-7 82-84, Wagoneer 84-86
17786	WC17786	38.1 mm 1-1/2"	Chrysler Tras. Izq. Der. Dodge Camion 400-700 57-68.
18179	WC36074	28.5 mm 1-1/8"	Chrysler Del. Izq. Dodge D-300 70.
18180	WC36075	28.5 mm 1-1/8"	Chrysler Del. Der. Dodge D-300 70.
18196	WC18196	38.1 mm 1-1/2"	Chevrolet Tras. Izq. C-40, C-50, C-60 53-65
18290	WC18290	28.5 mm 1-1/8"	Ford Del. Izq. F-100 70-71, Vam Del. Izq. Vam Jeep DJ-5 70-73, Wagoneer J-164 70-73
18291	WC18291	28.5 mm 1-1/8"	Ford Del. Der. F-100 70-71, Vam Del. Der. Vam Jeep DJ-5 70-73, Wagoneer J-164 70-73
18984	WC37218	26.9 mm 1-1/16"	Chrysler Tras. Izq. D-350 Microbus 81-87, Ford Tras. Izq. F-350 71-83, P-350 Microbus 72-78.
18985	WC37219	26.9 mm 1-1/16"	Chrysler Tras. Der. D-350 Microbus 81-87, Ford Tras. Der. F-350 71-83, P-350 Microbus 72-78.
19107	WC19107	41.3 mm 1-5/8"	Chrysler Tras. Izq. Der. Dodge 600, 700 57-58
19109	WC19109	44.4 mm 1-3/4"	Ford Tras. Der. Camion 700 57-64
19746	WC19746	38.1 mm 1-1/2"	Ford Tras. Izq. Der. F - 600 80-82.
20932	WC20932	28.5 mm 1-1/8"	Chevrolet Del. Izq. Camioneta C-10 60-63, P-10 61-63





CILINDRO DE RUEDA			
No. PARTE LUSAC	No. PARTE RAYBESTOS	DIAMETRO	APLICACIÓN
20933	WC20933	28.5 mm 1-1/8"	Chevrolet Del. Der. Camioneta C-10 60-63, P-10 61-63
24489	WC24489	41.3 mm 1-5/8"	Chevrolet Del. Izq. Sup.& Inf. Tras. C-50 70-72, C-60 70-88, C-65 79-85, Chrysler Del. Izq. Sup. Inf. Tras. D-500 70-77, D-600 70-77, Ford Del. Izq. B-600, F-600 70-79
24954	WC24954	28.5 mm 1-1/8"	Chrysler Del. Der. Dodge D-100 70-71. D-300 71
24955	WC24955	28.5 mm 1-1/8"	Chrysler Del. Izq. Dodge D-100 70-71. D-300 71
25459	WC25459	41.3 mm 1-5/8"	Chevrolet Tras. Izq. C-60, C-70 65-67 (Superior), Chrysler Dodge 500,600 65-68Tras Izq (Superior), Ford Tras. Izq. Camión Varios 61-68
25463	WC25463	41.3 mm 1-5/8"	Chevrolet Tras. Izq. C-60, C-70 65-67 (Inferior), Chrysler Dodge 500,600 65-68Tras Izq (Inferior), Ford Tras. Izq. Camión Varios 61-68 (Inferior)
26159	WC37180	38.1 mm 1-1/2"	Ford Tras. Izq. Der. Camion B-600, F-600, 84-88
26172	WC26172	44.4 mm 1-3/4"	Chevrolet Tras. Izq. Der. Camion C- 60 70-88, C65 79-85
27342	WC27342	38.1 mm 1-1/2"	Chrysler Tras. Izq. Der. Dodge D-600 70-77.
28661	WC28661	38.1 mm 1-1/2"	Chrysler Tras. Izq. Der. Dodge D-500 70-71, D-600 . 70-77.
28720	WC28720	28.5 mm 1-1/8"	Chrysler Del. Der. Dodge Camioneta. D-100, 150, 200, 250 60-64, D-300, 350 63-68
28803	WC28803	38.1 mm 1-1/2"	Chrysler Del. Izq. Der. Dodge Camion D-600 1970-77, D- 500,900, 57-68.
28805	WC36020	23.0 mm 29/32"	Ford Tras. Der. Mustang 70-72.
28850	WC28850	38.1 mm 1-1/2"	Ford Tras. Izq. Der. Camion D-600 70-77.
32349	WC37091	31.7 mm 1-1/4"	Chevrolet Del. Izq. Camion C-60 70, 83-88, C-65 79-85.
32350	WC37092	31.7 mm 1-1/4"	Chevrolet Del. Der. Camion C-60 70, 83-88, C-65 79-85.
32357	WC37248	34.9 mm 1-3/8"	Chevrolet Del. Izq. Camion C-60 71-88.
32358	WC37249	34.9 mm 1-3/8"	Chevrolet Del Der. Camion C-60 71-88.
32555	WC32555	28.5 mm 1-1/8"	Chrysler Tras. Der. Dodge Monaco 60-61.
34073	WC36044	23.8 mm 15/16"	Ford Del. Der. Camion Ford F- 450, F-500 57-69.
34177	WC34177	25.4 mm 1"	Chrysler Del. Izq. Dart 63-66, Valiant 60-66, Rambler 60-63
34178	WC34178	25.4 mm 1"	Chrysler Del. Der. Dart 63-66, Valiant 60-66, Rambler 60-63
34333	WC19086	28.5 mm 1-1/8"	Chevrolet Del. Izq. Camioneta. C-30, C-35 70-71.
34334	WC19087	28.5 mm 1-1/8"	Chevrolet Del. Der. Camioneta. C-30, C-35 70-71.
34401	WC19090	22.2 mm 7/8"	Chevrolet Del. Izq. Camion C-40 70-72, C-50 73-88.
34402	WC19091	22.2 mm 7/8"	Chevrolet Del. Der. Camion C-40 70-72, C-50 73-88.
34474	WC34474	28.5 mm 1-1/8"	Chevrolet Tras. Izq. C-30, C-35 71
34475	WC34475	28.5 mm 1-1/8"	Chevrolet Tras. Der. C-30, C-35 71
34876	WC34876	20.6 mm 13/16"	Chrysler Tras. Izq. Der. Dart 70-76, Valiant Duster 70-76, Ford Tras. Izq. Der. Ford Mustang 79-81, Ford Mustang 79-81, Ranger 01-03., Vam Tras. Izq. Der. Vam Gremlin 74-76
35325	WC36057	28.5 mm 1-1/8"	Chevrolet Tras. Izq. C-30, C-35 73, Chrysler Tras. Izq D-250 86-87, D-350 Microbus 90-93, Ford Tras. Izq. F-100 72, F-200 87-89, F-350 84-86
35326	WC36058	28.5 mm 1-1/8"	Chevrolet Tras. Der. C-30, C-35 73, Chrysler Tras. Der. D-250 86-87, D-350 Microbus 90-93, Ford Tras. Der. F-100 72, F-200 87-89, F-350 84-86
37208	WC37208	19.0 mm 3/4"	Nissan Tras. Izq. Der. Pick Up Doble Cabina 82-96, Pick Up Estaquitas 70-72, y87-94 Cil. Tokico
37209	WC37209	20.6 mm 13/16"	Nissan Del. Izq. Der. Pick Up Estaquitas 70-72, y 95-03, Pick Up D-21 02-03, Cil. Nabco
37210	WC37210	20.6 mm 13/16"	Nissan Tras. Izq. Der. Pick Up Estaquitas 70-86 Cil. Nabco
37250	WC37250	30.1 mm 1-3/16"	Ford Tras. Izq. Econoline E-350 98, P-350 Microbus 97.
37251	WC37251	30.1 mm 1-3/16"	Ford Tras. Der. Econoline E-350 98, P-350 Microbus 97.
37271	WC37271	25.4 mm 1"	Ford Tras. Izq. Der. Galaxie 73-74, LTD 75-78
37274	WC37274	20.6 mm 13/16"	Nissan Tras. Izq. Der. Datsun Sedan 73-82, Sakura 82.
37276	WC37276	19.0 mm 3/4"	Toyota Tras. Izq. Der. Carina 72-73, Celica 71-74. Corolla 70-74. USA
37277	WC37277	20.6 mm 13/16"	Toyota Tras. Izq. Der. Corolla 75-79. USA
37322	WC37322	20.6 mm 13/16"	Ford Tras. Izq. Courier 72-76 USA
37323	WC37323	20.6 mm 13/16"	Ford Courier Tras. Der. 72-76 USA
37336	WC37336	19.0 mm 3/4"	Chrysler Dodge Tras. Izq. Der. Colt 78-79 USA , Hyundai Tras. Izq. Der. Hyundai Pony 85-91 USA
37358	WC37358	17.4 mm 11/16"	Nissan Tras. Izq. Der. Tsubame 93-04 Nacional, Nissan 310 79-82. F-10 76-78. Sentra 87-90. Stanza 86. Tras. Izq. Der. USA
37376	WC37376	19.0 mm 3/4"	Chrysler Dodge Avenger 95-00, Sebring 95-05, Tras. Izq. Der. Colt 81-91 USA, Hyundai Tras. Izq. Der. Hyundai Excel 86-89 USA, Mitsubishi Eclipse 95-05, Glant 94-03,Tras. Izq. Der. Mitsubishi Mirage 85-88, Precis 87-89. USA
37377	WC37377	19.0 mm 3/4"	Chrysler Dodge Tras. Izq. y Der. D50 79-86 USA, Mitsubishi Pickup 83-86, USA
37382	WC37382	19.0 mm 3/4"	Nissan Del. Izq. pick up 620 72-77. USA

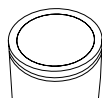



CILINDRO DE RUEDA			
No. PARTE LUSAC	No. PARTE RAYBESTOS	DIAMETRO	APLICACIÓN
37404	WC37404	19.0 mm 3/4"	Toyota Tras. Izq. Der. Celica 82-85 USA
37405	WC37405	22.2 mm 7/8"	Nissan 200SX 84-85; Nissan 280Z 77-78, Nissan 810/810 Maxima 81-84, NissanMaxima 82-84 Tras Izq Der USA
37407	WC37407	20.6 mm 13/16"	Nissan Tras. Izq. Der. Ninja Turbo 86-87, Sakura 83-86, Samurai 84-87, Ichi Van87-94
37420	WC37420	22.2 mm 7/8"	Toyota Tras. Izq. Der. Pickup 79-93., Toyota Previa 91-96. USA
37459	WC37459	23.8 mm 15/16"	Toyota Tras. Izq. Der. Pickup 79-93. USA
37476	WC37476	25.4 mm 1"	Ford Del. Izq. Der. Courier 77-81 USA
37499	WC37499	15.8 mm 5/8"	Nissan Tras. Izq. Der. pick up 620 81-88. USA
37509	WC37509	15.8 mm 5/8"	Nissan Tras. Izq. Der. pick up 720 80-81, USA
37529	WC37529	20.6 mm 13/16"	Ford Tras. Izq. Escort 83-90, Mercury LN7 83, Lynx 83-87 USA
37530	WC37530	20.6 mm 13/16"	Ford Tras. Der. Escort 83-90, Mercury LN7 83, Lynx 83-87 USA
37539	WC37539	25.4 mm 1"	Chevrolet Tras. Izq. Der. LUV 81-82 USA , Isuzu Tras. Izq. Der.Isuzu Pickup81-83 y 91-92, USA
37548	WC37548	19.0 mm 3/4"	Mazda Tras. Izq. RX7 81-85. USA
37549	WC37549	19.0 mm 3/4"	Mazda Tras. Der. RX7 81-85. USA
37569	WC37569	17.4 mm 11/16"	Nissan Tras. Izq. Der. Samurai 81-84
37571	WC37571	17.4 mm 11/16"	Nissan Tras. Izq. Der. pick up 720 82-86, pick up D21 86-89 USA
37573	WC37573	20.6 mm 13/16"	Hyundai Tras. Izq. Der. Excel 90-91, Scoupe 91-92 USA, Mitsubishi Tras. Izq.Der. Mitsubishi Precis 90-91 USA, Renault Tras. Izq. Der. Renault Alliance 84- 86, Encore 85-86, GTA 87 USA
37574	WC37574	19.0 mm 3/4"	Ford Tras. Izq. Der. Ranger 96-00, Tambor 9"
37575	WC37575	19.0 mm 3/4"	Mazda Tras. Izq. Der. 323 86-87, 626 83-87 USA
37577	WC37577	19.0 mm 3/4"	Geo Tras. Izq. Der. Prizm 90-92 USA , Toyota Tras. Izq. Der. Toyota Celica 90-91, Corolla 88-92 USA
37581	WC37581	19.0 mm 3/4"	Acura Tras. Izq. Integra 86-89 USA
37582	WC37582	19.0 mm 3/4"	Acura Tras. Der. Integra 86-89 USA , Honda Civic 80-89, Honda CRX 84-89,Honda Prelude 82 Tras. Der USA
37584	WC37584	19.0 mm 3/4"	Honda Tras. Izq. Der. Accord 82-85, Honda Prelude 83 USA
37585	WC37585	19.0 mm 3/4"	Chevrolet Tras. Izq. Der. Celebrity, 83-87 Century, 83-87 Nacional, Buick Electra 85-86, Park Avenue 85-86, Cadillac Deville/Concours 85-86, Fleetwood 85-86,Oldsmobile Ciera 85-86, Oldsmobile 98, Pontiac 6000 83-87 USA
37595	WC37595	19.0 mm 3/4"	Mazda Tras. Izq. Pickup B-2000, B-2200 83-84. USA
37599	WC37599	22.2 mm 7/8"	Chevrolet Tras. Izq. Der Luv 97-05 . Nacional, Isuzu Tras. Izq. Der. PickupRodeo 89-97, Amigo 89-93. Trooper II 84-87. USA
37601	WC37601	20.6 mm 13/16"	Chrysler Tras. Izq. Dodge D50, Ram 50, 83-86 USA, Mitsubishi Tras. Izq.Mitsubishi Montero, 83-86 Mitsubishi Van 87-90 USA
37604	WC37604	14.2 mm 9/16"	Nissan Tras. Izq. Der. pick up 720 80-83, Nissan pick up D-21 86 USA
37619	WC37619	19.0 mm 3/4"	Mazda Tras. Der. Pickup B-2000, B-2200 83-84. USA
37625	WC37625	19.0 mm 3/4"	Chevrolet Tras. Izq. Der. Camaro 84-88 USA , Pontiac Tras. Izq. Der. Firebird84-88 USA
37626	WC37626	15.8 mm 5/8"	Nissan Tras. Izq. Der. Pick up 720 83-86, Nissan Pick up D21 86 , USA
37634	WC37634	19.0 mm 3/4"	Ford Tras. Izq. Der. Bronco II 84-90, Ranger 84-86 y 90-92 USA, Mazda Tras. Izq. Der. Mazda Truck Pickup 94-96 USA, Toyota Pickup 4X4 84-85 USA
37635	WC37635	19.0 mm 3/4"	Geo Tras. Der. Prizm 90-92 USA , Toyota Tras. Der. Toyota Celica 90-91,Corolla 88-92 USA
37636	WC37636	19.0 mm 3/4"	Geo Tras. Izq. Prizm 90-92 USA , Toyota Tras. Izq. Toyota Celica 90-91,Corolla 88-92 USA
37637	WC37637	17.4 mm 11/16"	Geo Tras Izq. Prizm 93-96 USA , Toyota Tras Izq. Toyota Corolla 85-99 USA
37640	WC37640	20.6 mm 13/16"	Ford Tras. Izq. Der. Bronco II 84-90, Ranger 84-86 y 90-96 USA , MazdaTras. Izq. Der. Mazda Pickup 94-96 USA
37643	WC37643	20.6 mm 13/16"	Jeep Tras Izq Der Jeep Cherokee 81-83, Jeep Grand Wagoneer 84-93, JeepJ10, J20 87-90, Jeep Wagoneer 81-873 USA
37644	WC37644	22.2 mm 7/8"	Chevrolet Tras. Izq. Der. Blazer 83-88, S10 Pickup 82-88 USA, GMC Tras. Izq.Der. S, T Jimmy 83-88, S, T15 Pickup 82-88 USA
37646	WC37646	17.4 mm 11/16"	Geo Tras. Der. Prizm 89-97, Toyota Tras. Der. Toyota Corolla 88-89, Tercel 83-99, Paseo 92-97. USA
37654	WC37654	22.2 mm 7/8"	Toyota Tras. Izq. Der. Pickup 85-95 USA
37660	WC37660	22.2 mm 7/8"	Ford Tras. Izq. Der. Focus LX, SE, ZTS, Wagon 02-04, Focus Zx3 00-04
37663	WC37663	20.6 mm 13/16"	Ford Tras. Izq. Der. Aerostar Van 86-89, Ranger 87-94 USA , Mazda Pickup 94USA
37664	WC37664	17.4 mm 11/16"	Chevrolet Tras. Izq. Der. Spectrum 85-88 USA , Isuzu Tras. Izq. Der. Isuzu I-Mark 85-89 USA
37684	WC37684	23.8 mm 15/16"	Nissan Tras. Izq. Der. Pick Up Estaquitas 87-08, Pick Up D-21 92-08, ChasisLargo 97-08, NP300 Gasolina 09-12

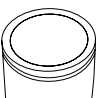



CILINDRO DE RUEDA			
No. PARTE LUSAC	No. PARTE RAYBESTOS	DIAMETRO	APLICACIÓN
37685	WC37685	15.8 mm 5/8"	Nissan Tras. Izq. Der. Sentra USA 86-90
37686	WC37686	17.4 mm 11/16"	Nissan Tras. Izq. Der. Trk. D21 86-89 4 Wheel Drive USA.
37687	WC37687	19.0 mm 3/4"	Toyota Tras. Izq. Camry 87-91 USA
37688	WC37688	19.0 mm 3/4"	Toyota Tras. Der Camry 87-91 USA
37690	WC37690	25.4 mm 1"	Chevrolet Tras Izq Der Celebrity 84-87, Century 84-87 Nacional, Toyota Tras Izq Der Toyota 4Runner 96-00, Landcruiser 81-95, Tundra 00-04 USA
37693	WC37693	19.0 mm 3/4"	Nissan Tras. Izq. Der. Altima 96-00
37694	WC37694	19.0 mm 3/4"	Chevrolet Tras. Izq. Der. Beretta 87-91 USA
37696	WC37696	20.6 mm 13/16"	Chrysler Tras Izq Der Dakota 96 Nacional Dakota 87-93. USA
37697	WC37697	19.0 mm 3/4"	Ford Tras. Izq. Thunderbird 85-88.
37698	WC37698	19.0 mm 3/4"	Ford Tras. Der. Thunderbird 85-88.
37707	WC37707	20.6 mm 13/16"	Honda Tras. Izq. Der. Honda Accord 86-88. USA
37708	WC37708	22.2 mm 7/8"	Mitsubishi Tras. Izq. Mitsubishi Montero Sport 03-04 Nacional, Chrysler Tras. Izq. Dodge Power Ram 50 87-88, Ram 50 87-88 USA, Mitsubishi Pickup 87-88 USA
37709	WC37709	22.2 mm 7/8"	Mitsubishi Tras. Der. Mitsubishi Montero Sport 03-04 Nacional, Chrysler Tras. Der. Dodge Power Ram 50 87-88, Ram 50 87-88 USA, Mitsubishi Pickup 87-88 USA
37711	WC37711	23.8 mm 15/16"	Chrysler Tras. Der. Dodge Power Ram 50 87-88, Ram 50 87-88 USA ,Mitsubishi Tras. Der. Mitsubishi Pickup 87-88, USA
37751	WC37751	19.0 mm 3/4"	Mazda Tras. Der. Pickup B-2000 86-87, B-2200 83-93. B-2600 86-93. USA
37752	WC37752	19.0 mm 3/4"	Mazda Tras. Izq. Pickup B-2000 86-87, B-2200 83-93. B-2600 86-93. USA
37779	WC37779	19.0 mm 3/4"	Chevrolet Tras. Izq. Der. Silhouette 91
37782	WC36076	20.6 mm 13/16"	Ford Tras. Izq. Fairmont, Fairmont Vagoneta 78-83, Mustang 82-84, Vam Tras. Izq. Vam Gremlin 77-83, Javelin 70-73, Pacer 79, Rally 70-73, 77-83
37783	WC36077	20.6 mm 13/16"	Ford Tras. Der. Fairmont, Fairmont Vagoneta 78-83, Mustang 82-84, Vam Tras. Der. Vam Gremlin 77-83, Javelin 70-73, Pacer 79, Rally 70-73, 77-83
37786	WC37786	22.2 mm 7/8"	Suzuki Pick Up Samurai 86-95 USA Tras. Izq. Der.
37787	WC37787	17.4 mm 11/16"	Chrys. Tras Izq Der Neon 00-05, Ford Escort 94-01, Escort Vagoneta 94-99
37799	WC37799	17.4 mm 11/16"	Chevrolet Tras. Izq. Der. LeMans 88-93 USA, Isuzu Tras. Izq. Isuzu Optima 88-91 USA
37841	WC37841	22.2 mm 7/8"	Chrysler Town and Country Van 97-07, Voyager 00-03, Dodge Caravan 96-07, Plymouth Voyager 97-00 Tras Izq Der USA, Toyota 4 Runner 87-93, Pick up 87-95, T100 93-94, Tacoma 95-04 Tras Izq Der USA
37842	WC37842	23.8 mm 15/16"	Toyota Tras. Izq. Der. 4-Runner 88-89 y 92-00, T100 Pick-up 93-98. USA
37844	WC37844	19.0 mm 3/4"	Chrysler Tras. Izq. Der. PT Cruiser 01-06 para tambor de 8.661", Dakota 96, Grand Voyager 91-95, Jeep Wrangler 96-06 Jeep Wrangler Sahara 97-06, Jeep Wrangler Rubicon 03-06, Town & Contry 93-95, Voyager 94-95 Nacional Dodge Dakota 87-93. USA
37846	WC37846	19.0 mm 3/4"	Honda Tras. Izq. Civic 97-01
37847	WC37847	19.0 mm 3/4"	Honda Tras. Der. Civic 97-01
37848	WC37848	19.0 mm 3/4"	Toyota Tacoma 95-04, Toyota 4 Runner 87-03, Toyota Pickup 87-95, Toyota T100 93-94 Tras Izq Der USA
37849	WC37849	19.0 mm 3/4"	Toyota Tacoma 95-04 Tras Izq Der USA
37850	WC37850	15.8 mm 5/8"	Geo Tras. Izq. Der. Metro 89-97 USA , Suzuki Tras. Izq. Der. Suzuki Swift 89-98. USA
37851	WC37851	15.8 mm 5/8"	Mitsubishi Eclipse 94 Tras Izq Der USA
37852	WC37852	23.8 mm 15/16"	Chevrolet Tras. Der. Geo Traker 93-95.
37853	WC37853	23.8 mm 15/16"	Chevrolet Tras. Izq. Geo Traker 93-95.
37854	WC37854	22.2 mm 7/8"	Chevrolet Tras. Izq. Der. Blazer 95-97, S-10 Pick Up 03-04.
37855	WC37855	23.8 mm 15/16"	Chevrolet Tras. Izq. Der. Boneville 94-95, Cadillac De Ville con-cours 94-96, Cadillac De Ville 91-93, Oldsmobile 88' 92, 94-95, Silhouette 92, 94-95, Lumina Apv 95-96, Venture Apv 97-04.
37856	WC37856	22.2 mm 7/8"	Ford Tras. Izq. Der. Aeroestar 91-93, Explorer 91-94.
37857	WC37857	25.4 mm 1"	Ford Tras. Izq. Der. Sable 94-95. Nissan Quest 97-98.
37858	WC37858	20.6 mm 13/16"	Honda Tras. Izq. Acord L4 96-02, Accord V6 98 00
37859	WC37859	20.6 mm 13/16"	Honda Tras. Der. Acord L4 96-02, Accord V6 98 00
37862	WC37862	20.6 mm 13/16"	Jeep Cherokee 94-01, Jeep Wrangler 93-99. Tras. Izq. Der
37863	WC37863	19.0 mm 3/4"	Chrysler Tras. Izq. Der. Grand Voyager 4X4 95, Town & Country 93-96, Voyager 94-95 4X4 sin ABS USA.
37864	WC37864	15.8 mm 5/8"	Chrysler Tras. Izq. Der. Spirit 90-95.
37867	WC37867	17.4 mm 11/16"	Chevrolet Astro Mini Van 85-86, Safari Mini Van 85-86 Tras Izq Der USA
37869	WC37869	15.8 mm 5/8"	Nissan Tras. Izq. Der. Sentra 1.6 Lts 92 y 96-00, Tsuru GSR 2000 93-96 Sentra 2.0 Lts. 96-01.



CILINDRO DE RUEDA			
No. PARTE LUSAC	No. PARTE RAYBESTOS	DIAMETRO	APLICACIÓN
37870	WC37870	20.6 mm 13/16"	Nissan Tras. Izq. Der. Pick Up D21 90-92, Urvan 02-11 Nacional, Nissan Tras. Izq. Der. Pathfinder 89-92 USA
37871	WC37871	20.6 mm 13/16"	Nissan Tras. Izq. Der. Pathfinder Xe 97-98.
37872	WC37872	22.2 mm 7/8"	Nissan Tras. Izq. Der. Pick Up D-21 92-01, Pick Up 250 94-96.
37944	WC37944	25.4 mm 1"	Chevrolet Tras. Der Superior. Chev. 40, 400, 4000 Series 89-92 USA, GMCTras. Der. GMC 40 Series, 89-92 GMC 400, 4000, 4500 Series 88-90 USA, Isuzu Tras. Der. Isuzu. 88-94 USA
37946	WC37946	25.4 mm 1"	Chevrolet Tras. Izq. Chev. 40, 400, 4000 Series 89-92 USA, GMC Tras. Izq. GMC 40 Series 88-90, GMC 400, 4000, 4500 Series 89-92 USA, Isuzu Tras. Izq. Isuzu 88-94. USA
37961	WC37961	17.4 mm 11/16"	Suzuki Tras Der Suzuki Aerio 06-07 Nacional, Geo Metro 92-96 Tras Der USA, Suzuki Tras Der Esteem 95-02; Suzuki Swift 89-94 USA
37962	WC37962	17.4 mm 11/16"	Suzuki Tras Izq Suzuki Aerio 06-07 Nacional, Geo Metro 92-96 Tras Izq USA, Suzuki Tras Izq Esteem 95-02; Suzuki Swift 89-94 USA
37967	WC37967	19.0 mm 3/4"	Chevrolet Tras. Izq. Der. Blazer 98-01, S-10 Pick Up 95-02.
37969	WC37969	19.0 mm 3/4"	Chrysler Dodge 2000 GTX 89-92, Tras Izq Der USA, Eagle 2000 GTX(Canada)90-93 Tras Izq Der USA, Mitsubishi Galant 89-93, Mitsubishi Mirage 93- 98 Tras Izq Der USA
37970	WC37970	19.0 mm 3/4"	Chrysler Tras. Izq. Der. Dodge Breeze 96, Stratus 95-00.
37973	WC37973	20.6 mm 13/16"	Chevrolet Tras. Izq. Der. Firebird Transam 94-97
37975	WC37975	22.2 mm 7/8"	Chevrolet Tras. Der. Geo Tracker 98
37976	WC37976	22.2 mm 7/8"	Chevrolet Tras. Izq. Geo Tracker 98.
37984	WC37984	17.4 mm 11/16"	Chrysler Tras. Izq. Der. Grand Voyager 91-00 2X4 con ABS USA.
37985	WC37985	23.8 mm 15/16"	Chevrolet Tras. Izq. Der. Express 1500, Express Cargo Van 1500 98-02, Express2500 y Express Cargo Van 2500 99-02, G15 98-02, Chrysler Tras. Izq. Der. Ram 1500 94-01, Ram 2500 94-01, Ram Quad Cab 2500 98-01, Ram Runner V-1096-97
37986	WC37986	19.0 mm 3/4"	Seat Tras. Izq. Der. Cordoba 01-06, Ibiza 01-06, Volkswagen. Tras. Izq. Der. Derby95-09, Golf A3 CL, GL, 93-99, Golf A3 GLS 93-99, Golf Cabrio A3 96-99, Jetta A3CL, GL 93-99, Jetta GLS A3 93-98, Lupo 05-09, Polo 03-07, Volkswagen Van 03-09
37995	WC37995	20.6 mm 13/16"	Hyundai Tras. Der. Hyundai Excel 90-94, Scoupe 93-95 USA, Mitsubishi Tras. Der. Mitsubishi Precis 92-93 USA
37996	WC37996	20.6 mm 13/16"	Hyundai Tras. Izq. Hyundai Excel 90-94, Scoupe 93-95 USA, Mitsubishi Tras. Izq. Mitsubishi Precis 92-93 USA
37997	WC37997	22.2 mm 7/8"	Ford Tras. Izq. Der. Contour 96-00, Mystique 95-00.
37999	WC37999	23.8 mm 15/16"	Ford Tras. Izq. Der. Aeroestar 94-95
40416	WC36050	28.5 mm 1-1/8"	Chrysler Del. Izq. Dart 70, Super Bee 70, Valiant Duster 71-72, D-300 72-74.
40417	WC36051	28.5 mm 1-1/8"	Chrysler Del. Der. Dart 70, Super Bee 70, Valiant Duster 71-72, D-300 72-74.
40823	WC36100	26.9 mm 1-1/16"	Ford Del. Izq. Maverick 70, Falcon 6 Cil 63-70.
40951	WC36017	28.5 mm 1-1/8"	Ford Del. Izq. Maverick 71-75, F-350 87-89, Falcon 8 Cil 63-70, Vam Del. Izq. Vam Classic 70-73, Javelin 70, Rally 70-73, Jeep CJ-5 73-77
40952	WC36018	28.5 mm 1-1/8"	Ford Del. Der. Maverick 71-75, F-350 87-89, Falcon 8 Cil 63-70, Vam Del. Der. Vam Classic 70-73, Javelin 70, Rally 70-73, Jeep CJ-5 73-77.
40965	WC37231	25.4 mm 1"	VAM Del. Izq. Der. Willys Jeep 64-69, Jeep CJ-5 70-72.
41718	WC37083	26.9 mm 1-1/16"	Ford Del. Izq. Camioneta. F-350 70-71. Chevelle 73-75.
41719	WC37084	26.9 mm 1-1/16"	Ford Del. Izq. Der. Camioneta. F-350 70-71, Chevelle 73-75.
42190	WC37035	26.9 mm 1-1/16"	Ford Del. Izq. Camion B-500 70-71, F-500 70-71 USA.
43375	WC37033	28.5 mm 1-1/8"	Chrysler Del. Izq. D-500 70-71, D-600 75-76, Ford Del. Izq. Ford B-600 74-88, F-600 70-82.
43376	WC37034	28.5 mm 1-1/8"	Chrysler Del. Der. D-500 70-71, D-600 75-76, Ford Del. Der. Ford B-600 74-88, F-600 70-82.
45873	WC37024	22.2 mm 7/8"	Chevrolet Tras. Izq. Der. Chevelle 71-75, Chevelle Malibu 71-75, Chevy Nova 73-76
45995	WC37019	28.5 mm 1-1/8"	Chevrolet Del Izq. Chevelle Malibu 70, Opel 70-72
45997	WC37025	28.5 mm 1-1/8"	Chev. Del. Izq. C-10 70-71.
45999	WC37021	23.8 mm 15/16"	Chevrolet Tras. Izq. Der. Chevelle 70, Chevelle Malibu 70, Chevy Nova 77-78, Opel 70-72
46251	WC37014	28.5 mm 1-1/8"	VAM Del. Izq. American 71-73. Classic 70-73, Gremlin 74-76, Rally 70-73.
46252	WC37015	28.5 mm 1-1/8"	VAM Del. Der. American 71-73. Classic 70-73, Gremlin 74-76, Rally 70-73.
48418	WC37089	20.6 mm 13/16"	VAM Tras. Izq. Willys Jeep 64-69, CJ-5 70-72, DJ-5 70-73.
48419	WC37090	20.6 mm 13/16"	VAM Tras. Der. Willys Jeep 64-69, CJ-5 70-72, DJ-5 70-73.
49233	WC31140	27.7 mm 1-3/32"	Ford Del. Der. 60-69.
49331	WC37108	21.4 mm 27/32"	Ford Tras. Izq. Der. Maverick 70, Falcon 6 Cil 63-70.
49680	WC37040	28.5 mm 1-1/8"	Chevrolet Tras. Izq. Camioneta. C-20 71-76 USA.
49681	WC37039	28.5 mm 1-1/8"	Chevrolet Tras. Der. Camioneta. C-20 71-76 USA.
50014	WC37016	23.8 mm 15/16"	VAM Tras. Izq. Der. American 71-73, Classic 70, Rally 70-75, Gremlin 77-78, Javelin 68-70

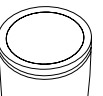



CILINDRO DE RUEDA			
No. PARTE LUSAC	No. PARTE RAYBESTOS	DIAMETRO	APLICACIÓN
50371	WC35073	27.7 mm 1-3/32"	VAM Tras. Izq. American 65-69. USA
50372	WC35074	27.7 mm 1-3/32"	VAM Tras. Der. American 65-69. USA
51081	WC37048	23.8 mm 15/16"	Chevrolet Tras. Izq. Der. Caprice 78-82, Impala 71-75, Blazer Nevada 91, C-10 74-78, C-15 82-87, G-20 95, Vam Tras. Izq. Der. Vam Wagonner 77-83.
51087	WC37079	30.1 mm 1-3/16"	Chevrolet Del. Der. Impala 70
51088	WC37080	25.4 mm 1"	Chevrolet Tras. Izq. Der. Impala 70, C-10 74-78, C-15 82-87, C-20,25 79-87, C-30, 35 74-75, Suburban 87.
51135	WC37042	38.1 mm 1-1/2"	Chevrolet Inf. Tras. Izq. Der. Camion C-50, C-60 64-65.
51136	WC37078	30.1 mm 1-3/16"	Chevrolet Del. Izq. Impala 70
55890	WC37118	27.7 mm 1-3/32"	Ford Del. Izq. B-600, F-600 70-76 y 80-85,
55891	WC37119	27.7 mm 1-3/32"	Ford Del. Der. B-600, F-600 70-76 y 80-85,
57146	WC37132	25.4 mm 1"	Ford Tras. Izq. F-200 86, F-350 70-72, 84-92, Vam Tras. Izq. Vam. Jeep DJ-5 70-73, Wagoneer J-164 70-73.
57147	WC37133	25.4 mm 1"	Ford Tras. Der. F-200 86, F-350 70-72, 84-92, Vam Tras. Der. Vam Jeep DJ-5 70-73, Wagoneer J-164 70-73.
57150	WC37153	41.3 mm 1-5/8"	Chevrolet Tras. Izq. C-50 70-72, C-60, C-70, 1968-69 (Superior), Ford Tras. Izq. Camiones, Ford F-600 69, F-700 66-67 (Superior)
57151	WC37154	41.3 mm 1-5/8"	Chevrolet Tras. Der. C-50 70-72, C-60, C-70, 1968-69 (Superior), Ford Tras. Der. Camiones, Ford F-600 69-72, F-700 66-67 (Superior)
57152	WC37155	41.3 mm 1-5/8"	Chevrolet Inferior Camiones Tras. Izq. C-50 70-72, Ford Inferior Camiones Tras. Izq. Ford F-600 69.
57153	WC37156	41.3 mm 1-5/8"	Chevrolet Inferior Camiones Tras. Der. C-50 70-72, Ford Inferior Camiones Tras. Der. Ford F-600 69.
57850	WC37158	38.1 mm 1-1/2"	Chevrolet Inf. Tras. Izq. Der. Camion C-30 70, C-40 70, C-50 70-72.
57851	WC37157	38.1 mm 1-1/2"	Chevrolet Sup. Tras. Izq. Der. Camion C-30, 35 70, C-40 70, C-50 70-72.
59240	WC17509	23.8 mm 15/16"	Izq. 3000, 3200 75-80, Ford Tras. Izq. Ford Econoline E-150, Club Wagon E-150 95-96, F-100 70-71, F-150 87-99, Galaxie 70-72. P-350 Microbus 72-76, VamTras. Izq. Vam American 74-76 y 83. Classic 74-76. Jeep CJ-5 73-75, Wagoner J-164 70-73 y 74-76
59241	WC17510	23.8 mm 15/16"	Der 3000, 3200 75-80, Ford Tras. Der. Ford Econoline E-150, Club Wagon E-150 95-96, F-100 70-71, F-150 87-99, Galaxie 70-72. P-350 Microbus 72-76, VamTras. Der. Vam American 74-76 y 83. Classic 74-76. Jeep CJ-5 73-75, Wagoner J-164 70-73 y 74-76
71202	WC37103	25.4 mm 1"	Chrysler Del. Izq. Dodge Dart 70-72. Valiant Duster 70-72.
71203	WC37102	25.4 mm 1"	Chrysler Del Der. Dodge Dart 70-72. Duster 70-72.
71211	WC37113	28.5 mm 1-1/8"	Chevrolet Del Der. Chevelle 70-72.
71216	WC37232	20.6 mm 13/16"	Ford Tras. Izq. Camioneta. E-200, 250 69-74 USA.
71221	WC37181	38.1 mm 1-1/2"	Chevrolet Inf. Tras. Izq. Der. Camion 40 70.
71222	WC37160	38.1 mm 1-1/2"	Chevrolet Sup. Tras. Izq. Der. Camion C-50 70-72.
71238	WC37152	41.3 mm 1-5/8"	Ford Tras. Izq. Der. B-600, F-600 70 - 88,
71940	WC37227	28.5 mm 1-1/8"	Ford Del. Izq. Camion B-600, F-600 74-79.
73500	WC37252	28.5 mm 1-1/8"	Ford Del. Izq. Camion B-600, F-600 70-88.
73608	WC37172	30.1 mm 1-3/16"	Chrysler Del. Der. Dodge Monaco 70-72, D-100 72-73.
73609	WC37171	30.1 mm 1-3/16"	Chrysler Del. Izq. Dodge Monaco 70-72, D-100 72-73.
73620	WC37267	23.8 mm 15/16"	Ford Tras. Der. F-150 80-83
73621	WC37268	23.8 mm 15/16"	Ford Tras. Izq. F-150 80-83
73623	WC37282	25.4 mm 1"	Ford Tras. Der. Camioneta. Ranchero 73-74. USA.
78315	WC36106	21.4 mm 27/32"	Ford Tras. Der. Maverick 71-73.
78743	WC37149	38.1 mm 1-1/2"	Ford Tras. Izq. Der. B-600, F-600 70-85.
78744	WC37240	38.1 mm 1-1/2"	Chevrolet Tras. Izq. Camioneta. C-30,35 71-72. C-40 71-72 Camion C-50 73-88, C-65 79-85.
78745	WC37241	38.1 mm 1-1/2"	Chevrolet Tras. Der. Camioneta. C-30,35 71-72. C-40 71-72 Camion C-50 73-88, C-65 79-85
78974	WC9025	25.4 mm 1"	78 y 80, Ram Van 1500 98-03, Ram 1500 02, Ram Wagon 1500 98-03, Ram 2500 00-02, Ram Van 2500 98-02, Ram Wagon 2500 98-02, W-250 (4 X 4) 89-93, Ram 3500 00-02, Ford Tras. Izq. Ford Econoline Van E-150 97-08, Club Wagon V6 E-150 97-03, Club Wagon V8 E-250 97-04, Econoline Wagon Diesel 01 y 03, Club Wagon V8 E-250 Chateau 95-96 y 98-00, Club Wagon E-350 97-98. F-150 84-86 y 97-04. F-200 86 y 90-91, F-250 92 y 94, F-250 y Super Duty 98-02, Lobo 97-99 y Lobo 250 99
78975	WC9026	25.4 mm 1"	78 y 80, Ram Van 1500 98-03, Ram 1500 02, Ram Wagon 1500 98-03, Ram 2500 00-02, Ram Van 2500 98-02, Ram Wagon 2500 98-02, W-250 (4 X 4) 89-93, Ram 3500 00-02, Ford Tras. Der. Ford Econoline Van E-150 97-08, Club Wagon V6 E-150 97-03, Club Wagon V8 E-250 97-04, Econoline Wagon Diesel 01 y 03, Club Wagon V8 E-250 Chateau 95-96 y 98-00, Club Wagon E-350 97-98. F-150 84-86 y 97-04. F-200 86 y 90-91, F-250 92 y 94, F-250 y Super Duty 98-02. Lobo 97-99 y Lobo 250 99



CILINDRO DE RUEDA			
No. PARTE LUSAC	No. PARTE RAYBESTOS	DIAMETRO	APLICACIÓN
79767	WC37290	26.9 mm 1-1/16"	Chevrolet Tras. Izq. Der C-30, C-35 76-78, 84-87, 90, 92-95, G-30 Express, Cargo Van 3500 97/01-03, G-30 97, 01-02, Silverado 2500 96-01, Chrysler Ram 2500 94-99, Ram 3500 94-01, Ram Van 3500 98-99, Ram Wagon 3500 98-99, Ram 4000 95-02. Ram Srt-10 05-06
079768	WC37337	30.1 mm 1-3/16"	Chevrolet Tras. Izq. Der. C-30, C-35 79-95, C-35, C-3500, C-3500 Hd 96-00, Microbus 88-00, Panel P-30 82-03.
79794	WC37334	26.9 mm 1-1/16"	Chevrolet. Del. Der C-30, 35 82-83, 88-89., Ford Del. Der Ford Camioneta 82-83, 88-89.
79985	WC37029	22.2 mm 7/8"	Ford Tras. Izq. Der. Mustang 74-78
No. PARTE LUSAC	No. PARTE RAYBESTOS	DIAMETRO	APLICACIÓN
80186	WC37648	20.6 mm 13/16"	Ford Tras. Izq. Camioneta. E-100 74. USA.
80187	WC37658	20.6 mm 13/16"	Ford Tras. Der. Camioneta. E-100 74. USA.
86000	WC37291	28.5 mm 1-1/8"	Chevrolet Tras. Izq. Der. Camioneta. C-30, 35 74-78.
90549	WC37109	22.2 mm 7/8"	Volkswagen Del. Izq. Der. Safari 71-77, Sedan 70-94
90550	WC37110	19.0 mm 3/4"	Volkswagen Tras. Izq. Der. Sedan 70-72
93356	WC37111	17.4 mm 11/16"	Volkswagen Tras. Izq. Der. Sedan 73-04
96387	WC37349	23.8 mm 15/16"	Volkswagen Tras. Izq. Der. Combi - Panel 70-01, Hormiga 76-78
96399	WC37332	17.4 mm 11/16"	Volkswagen Tras. Izq. Der. Atlantic 81-87, Caribe 78-87, Caribe Gti 83-86, Corsar 83-88, Corsar Variant 86-88, Derby 95-97. Golf A-2 C, CL, GL. Jetta A-2 87-92, Pointer 98-07, Volkswagen Van 03-09
96402	WC37345	14.2 mm 9/16"	Volkswagen Tras. Izq. Der. Caribe 77-79.
96613	WC37407	20.6 mm 13/16"	Nissan Tras. Izq. Der. Datsun 73-83, Sakura 82
99284	WC37342	22.2 mm 7/8"	Ford Tras. Izq. Der. Gran Marquis 82
101604	WC37400	19.0 mm 3/4"	Ford Tras. Izq. Der. Cougar 85-92, Mustang 80-93. Ranger Tambor de 9" 04-09
101610	WC37343	23.8 mm 15/16"	Ford Tras. Izq. Der. Grand Marquis 83-84, LTD 79-80, Crown Victoria 81.
103223	WC37593	27.7 mm 1-3/32"	Ford Del. Izq. Camion B-600, F-600 80-85.
103224	WC37594	27.7 mm 1-3/32"	Ford Del. Der. Camion B-600, F-600 80-85.
104384	WC37531	17.4 mm 11/16"	Chevrolet Tras. Izq. Der. Celebrity 83-89, Century 83-89, 92-93, Citation 83-86, Cutlass y Cutlass Eurosport 87-89, Pontiac Sunfire 97-02
106006	WC37236	22.2 mm 7/8"	Chrysler Tras. Izq. Der. Dodge D-100 72-73.
106315	WC37235	23.8 mm 15/16"	82, Magnum 81-82. Monaco 70-77, Super Bee 70, Valiant Duster 70-76, D-10070, y 73-80, D-150 81-93. D-250 86-93, W-150 85-87, W-250 4 X 4 89-93, Valiant/Volare 77-81, Ram Charger 85-01. Ram Van 1500, Ram Wagon 94-97. Ram Van 2500, Ram Wagon 2500 96-97.
106922	WC37537	26.9 mm 1-1/16"	Chrysler Tras. Izq. D-250 86-87. D-350, Microbus 88-90,
107475	WC37590	14.2 mm 9/16"	Chrysler Tras. Izq. Der. Dart E 89, Dart K 82- 88. Dart K Guayin 82-88. Magnum K 83-88. New Yorker 85-89, Phantom 87-89. Serie 600 K 84-85. Lebaron K 83-87, Volare K 82-88.
107476	WC37564	15.8 mm 5/8"	Chrysler Tras. Izq. Der. Dart K 82-88, Le Baron K 83-87, Magnum K 83-88, Neon 95-99, New Yorker 85-89, Phantom 87-89, Serie 600 K 84-85, Shadow 89-94, Shadow Gts Turbo 89, Volare K 82-88.
108106	WC37592	22.2 mm 7/8"	Ford Tras. Der. Ghia 91-94, Topaz 84-94
108107	WC37591	22.2 mm 7/8"	Ford Tras. Izq. Ghia 91-94, Topaz 84-94.
109532	WC37844	19.0 mm 3/4"	Chrysler Tras. Izq. Der. PT Crusier 01-06 para tambor de 8.661", Dakota 96, Grand Voyager 91-95, Jeep Wrangler 96-06 Jeep Wrangler Sahara 97-06, Jeep Wrangler, Jeep Wrangler Rubicon 03-06, Town Contry 93-95, Voyager 94-95.
110260	WC37625	19.0 mm 3/4"	Chevrolet Tras. Izq. Der. Chevelle Malibu 79-81, Montecarlo 81-84
112341	WC37677	22.2 mm 7/8"	Chevrolet Tras. Izq. Der. Bonneville 96-99, Cavalier 97-02, Cutlass 93-96, Cutlass Eurosport 93-96, Century 94-96.
112365	WC37668	25.4 mm 1"	Ford Tras. Izq. Der. Taurus 88-91.
113757	WC37262	30.1 mm 1-3/16"	Ford Tras. Der. F-200 90-91, F-250 92-97, F-350 90-04, P-350 Microbus 89-96.
113758	WC37263	30.1 mm 1-3/16"	Ford Tras. Izq. F-200 90-91, F-250 92-97, F-350 90-04, P-350 Microbus 89-96.
114197	WC37869	15.8 mm 5/8"	Nissan Tras. Izq. Der. Sentra 1.6 Lts 92 y 96-00, Tsuru III GS 93-14, Tsuru GSR 2000 93-96 Sentra 2.0 Lts. 96-01, Sentra GSS 96-00
116224	WC37785	30.1 mm 1-3/16"	Chevrolet Tras. Izq. Der. Blazer Nevada 92-94, C-15 94-99, C20, C25 95-01, Maxi Cab 91-93, Silverado 95-99, Sonora 00
116263	WC37784	28.5 mm 1-1/8"	Chevrolet Tras. Izq. Der. C-15 88-91, 94, 96-99, C20, C25 88-91, 96-01, Suburban 88.
116359	WC37781	25.4 mm 1"	Chevrolet Tras. Izq. Der. C-15 95, C-20, 25 92-95, Express 3500, Express Cargo Van 3500 98-00, G-30 98-00, Silverado 2500 96-01, Suburban 88-00
0116366	WC37778	17.4 mm 11/16"	Chevrolet Tras. Izq. Der. Cavalier 92-02, Cavalier Z24 91-96, Celebrity 87-89, Century 90-91, Cutlass 90-92, Cutlass Eurosport 91-92, Sunfire 97-02.
116384	WC37750	16.0 mm	Chevrolet Tras. Izq. Der. Cavalier 90-91, Cavalier Z24 91





CILINDRO DE RUEDA			
No. PARTE LUSAC	No. PARTE RAYBESTOS	DIAMETRO	APLICACIÓN
117345		19.0 mm 3/4"	Nissan Tras. Izq. Der. Datsun Sedan 81-84, Hikari 88-92, Tsuru I 84-87, Tsuru II 88-92,
129564	WC37857	25.4 mm 1"	Ford Tras. Izq. Der. Cougar 93-95. Thunderbird 89-96, Windstar 95-03.
370027	WC370027	19.0 mm 3/4"	Chrysler Tras. Izq. Der. Grand Voyager 96-02, Town Contry 97-00, Voyager 96-02
370031	WC370031	19.0 mm 3/4"	Ford Tras. Izq. Der. Ranger 96-97. Tambor 10"
370032	WC370032	23.8 mm 15/16"	Toyota Hiace 06-07 y 11-12 Nacional, Tacoma 95-04 USA Tras Izq Der
370042	WC370042	28.5 mm 1-1/8"	Ford Tras. Izq. Econoline Van E-250 97-99, Econoline Van E-350 99. Club Wa- gon V8 E-250 95-96, Club Wagon V8 E-350 XI 99-04, F-350 97-98.
370043	WC370043	28.5 mm 1-1/8"	Ford Tras. Der. Econoline Van E-250 97-99, Econoline Van E-350 99. Club Wa- gon V8 E-250 95-96, Club Wagon V8 E-350 XI 99-04, F-350 97-98.
370050	WC370050	20.6 mm 13/16"	Honda Civic 88-89 Tras Izq Der USA
370051	WC370051	20.6 mm 13/16"	Chrysler Tras. Izq. Der. Grand Voyager 97-02. Voyager 97-06, Town Contry 97-04.
370055	WC370055	22.2 mm 7/8"	Chevrolet Tras. Izq. Der. Malibu LX 97-01, Malibu LS 97-05, Grand Am 99-05
370061	WC370061	20.6 mm 13/16"	Ford Tras. Izq. Der. Ranger Tambor de 10" 98-09
370073	WC370073	22.2 mm 7/8"	Chevrolet Tras Izq Tracker 99-08
370074	WC370074	22.2 mm 7/8"	Chevrolet Tras Der Tracker 99-08
370077	WC370077	23.8 mm 15/16"	Chrysler Tras. Izq. Der. Ram Van 3500 00-02, Ram Wagon 3500 00-02.
370080	WC370080	20.6 mm 13/16"	Ford Contour 95-00, Ford Cougar 99-02 Nacional, Mercury Mystique 95-00 Tras Izq Der USA
370081	WC370081	17.4 mm 11/16"	Chrysler Tras. Izq. Der. Neon 00-01.
370083	WC370083	25.4 mm 1"	Nissan Tras. Izq. Der. Quest (Minivan) 99-02
370087	WC370087	22.2 mm 7/8"	Honda Odyssey Tras. Der. 00-01
370088	WC370088	22.2 mm 7/8"	Honda Odyssey Tras. Izq. 00-01
370091	WC370091	22.2 mm 7/8"	Ford Tras. Izq. Explorer 01. USA
370092	WC370092	22.2 mm 7/8"	Ford Tras. Der. Explorer 01 USA
370093	WC370093	20.6 mm 13/16"	Ford Tras. Izq. Der. Focus LX, SE, ZTS, Wagon 00-01
370094	WC370094	23.8 mm 15/16"	Ford Tras. Izq. Der. Escape 01-06, Mariner 05-10
370103	WC370103	20.6 mm 13/16"	Chevrolet :Aveo 08-14, Optra 06-07, Spark 13-14, Pontiac G3 06-09 Tras Izq Der
370105	WC370105	20.6 mm 13/16"	Chrysler Tras. Izq. Der. Jeep Liberty 02.
370106	WC370106	23.8 mm 15/16"	Nissan Altima 98-01 Tras Izq Der
370111	WC370111	22.2 mm 7/8"	Toyota Camry 02-06 Tras Izq
370112	WC370112	19.0 mm 3/4"	Toyota Matrix ZR 4 cil 1.8L 03-08, Matrix ZR "S" 4 cil 1.8L 04-08, Tras Izq Der
370113	WC370113	19.0 mm 3/4"	Volkswagen Derby 03-09, Jetta Clasico 10-14
370115	WC370115	20.6 mm 13/16"	Volkswagen Jetta clásico 08-16, Saveiro 10-14
370117	WC370117	22.2 mm 7/8"	Chevrolet Aztek Tras Izq Der 01-05
370121	WC370121	22.2 mm 7/8"	Ford Focus LX, SE, ZTS, Wagon Tras. Izq. y Der. 05-12
370123	WC370123	20.6 mm 13/16"	Honda Tras. Der. Civic 03-07
370127	WC370127	20.6 mm 13/16"	Honda Tras. Izq. Civic 03-07
370128	WC370128	25.4 mm 1"	Nissan Quest 01-03 Tras Izq Der
370129	WC370129	20.6 mm 13/16"	Mitsubishi Outlander 03-04 Tras Izq Der
370130	WC370130	22.2 mm 7/8"	Chevrolet Equinox; 05-06, Pontiac Torrent 06 Tras Izq Der
370131	WC370131	19.0 mm 3/4"	Honda Civic Tras Der 02
370132	WC370132	19.0 mm 3/4"	Honda Civic Tras Izq 02
370133	WC370133	17.4 mm 11/16"	Chevrolet Cavalier 03-04, Pontiac Sunfire 04-05 Tras Izq Der
370139	WC370139	19.0 mm 3/4"	Toyota Corolla 03-08, Yaris 04-14 Tras Der
370142	WC370142	15.8 mm 5/8"	Nissan Sentra 01-02 Tras Izq Der
370143	WC370143	22.2 mm 7/8"	Toyota Hiace 06-14, Tacoma 4X2 4X4 06-14 tras izq der
370146	WC370146	19.0 mm 3/4"	Toyota Corolla 03-08, Yaris 04-14 Tras Izq
370148	WC370148	23.8 mm 15/16"	Chevrolet Colorado 4 cil 2.9L 4X2 04-10, Colorado 5cil 4X2 04-10, Co- lorado 5cil 2.9L 4X4 05-10, GMC Canyon 07-10, Tras Izq Der
370149	WC370149	19.0 mm 3/4"	Honda: Civic 01-05 tras der
370152	WC370152	19.0 mm 3/4"	Honda: Civic 01-05 tras Izq
370153	WC370153	22.2 mm 7/8"	Suzuki Gran Vitara 4 cil 2.3L 06-08, Gran Vitara V6 2.7L,- Gran Vitara V6 2.7L 4X4 07-08, Tras Izq
370154	WC370154	22.2 mm 7/8"	Nissan Pathfinder XE Tras. Izq. y Der. 02-04
370155	WC370155	19.0 mm 3/4"	Mitsubishi Lancer 4 cil 2.0L 04-10, Lancer Ralliart 4 cil. 2.0L 05-06, Tras Izq Der
370157	WC370157	15.8 mm 5/8"	Nissan Sentra 03-06 Tras Izq Der
370158	WC370158	22.2 mm 7/8"	Nissan Frontier 4L Tras. Izq. y Der. 03



CILINDRO DE RUEDA			
No. PARTE LUSAC	No. PARTE RAYBESTOS	DIAMETRO	APLICACIÓN
370159	WC370159	22.2 mm 7/8"	Suzuki Gran Vitara 4 cil 2.3L 06-08, Gran Vitara V6 2.7L,- Gran Vitara V6 2.7L 4X407-08, Tras Der
370174	WC370174	22.2 mm 7/8"	Toyota Camry 02-06 Tras Der sustituye al WC 370122
370176	WC370176	20.6 mm 13/16"	Chrysler PT Cruiser 04-09 Tras Izq Der Para Tambor de 9"
370177	WC370177	26.9 mm 1-1/16"	Chrysler Dodge Dakota 05-12 Nacional, Mitsubishi Raider 06-09 USA Tras IzqDer
370180	WC370180	23.8 mm 15/16"	Chevrolet Cheyenne 02-09, Sierra 1500 07-08, Sierra Classic 1500 07, Sierra-Classic 1500HD 07, Silverado 1500 07-08, Silverado 1500HD 05-06, Silverado Classic 1500 07, Silverado Classic 1500HD 07 para 6400 Lbs tras Izq Der
370181	WC370181	26.9 mm 1-1/16"	Chevrolet Cheyenne 02-09, Sierra 1500 07-08, Sierra Classic 1500 07, Silverado 1500 03-08 para 7000 Lbs Tras Izq Der
370182	WC370182	19.0 mm 3/4"	Honda Civic 06-14, Honda Fit 06-13 Tras Izq Der
370183	WC370183	23.8 mm 15/16"	Toyota Tacoma 4X4 06-14 Tras Izq Der
370185	WC370185	19.0 mm 3/4"	Ford Ranger 01-06 Tras Izq Der
370186	WC370186	20.6 mm 13/16"	Chevrolet: HHR 06-09, HHR Panel 07-09, Pontiac G5 07-09 Tras Izq Der
370187	WC370187	22.2 mm 7/8"	Chevrolet: Malibu 05-07 Tras Izq Der
370189	WC370189	30.1 mm 1-3/16"	Chevrolet. Blazer 92-94, C10, C15 Pickup 88-99 Nacional, Chevrolet. Tahoe 95-01, Yukon 92-00 Tras Izq Der USA
370190	WC370190	23.8 mm 15/16"	Chevrolet Venture 97-04 Tras Izq Der Nacional, Chevrolet Pontiac Bonneville 91-95, Deville/Concours 91-02, Fleetwood 91-92, LeSabre 92- 95, Lumina APV Van92-96, Oldsmobile 88 92-95, Oldsmobile Silhouette Van 92 -04, Park Avenue 91- 95 Tras Izq Der USA
370191	WC370191	20.6 mm 13/16"	Pontiac Bonneville 91-95, Deville/Concours 91-02, Fleetwood 91-92, LeSabre 92-95, Lumina APV Van 92-96, Oldsmobile 88 92-95, Oldsmobile Silhouette Van 92-04, Park Avenue 91-95 Tras Izq Der USA
370194	WC370194	17.4 mm 11/16"	Chrysler Dodge Attitude 06-11 Nacional, Hyundai Accent 06-10, Kia Rio 06-10, Rio 5 06-10 USA Tras Izq Der
370195	WC370195	19.0 mm 3/4"	Chrysler: Tras Izq Der PT Cruiser 01-04 para tambor de 8.661"
370197	WC370197	20.6 mm 13/16"	Chrysler Dodge Avenger 08-09, Jeep Patriot 08-14, Caliber 07-12 Nacional, Sebring 07-09, Jeep: Compass 08-14 USA Tras Izq Der
370200	WC370200	26.9 mm 1-1/16"	Chevrolet Cheyenne 08-13, Silverado 1500 08-14, GMC Sierra 08-14 Tras IzqDer De 7000 LB
370201	WC370201	23.8 mm 15/16"	Chevrolet Colorado 09-12, Cheyenne 08-13, Silverado 1500 08-14, GMC Canyon 09-12, Sierra 08-14 Tras Izq Der De 6400 LB
370211	WC370211	23.8 mm 15/16"	Ford Escape 09-11, Mercury Mariner 10-11 Tras Izq Der
370212	WC370212	19.0 mm 3/4"	Nissan Sentra 07-12 Tras Izq Der
370213	WC370213	17.4 mm 11/16"	Nissan Tiida 07-11 Tras Izq Der Sin ABS
370214	WC370214	15.8 mm 5/8"	Nissan Sentra 07-11, Tiida 07-11 Tras Izq Der Con ABS
370225	WC370225	19.0 mm 3/4"	Ford Fiesta sedan 11-14, Fiesta sedan Tred 11-14 Tras Izq Der
370226	WC370226	20.6 mm 13/16"	Chevrolet Cruze 11-14, Sonic 12-14 USA tras Izq Der
370239	WC370239	30.1 mm 1-3/16"	Isuzu Elf 400 Diesel 07-11 Tras Der Frontal Del Der
370240	WC370240	30.1 mm 1-3/16"	Isuzu Elf 400 07-11 Tras Der Posterior Tras Der
370247	WC370247	30.1 mm 1-3/16"	Isuzu Elf 400 07-11 Tras Izq Posterior Del Izq
370254	WC370254	19.0 mm 3/4"	Nissan March 12-14, Versa 12-14 Tras Izq Der
370301		19.0 mm 3/4"	Volkswagen Tras. Izq. Der. Pointer 98-02, Pointer City 00-02, Pointer Vagoneta 99-02
370382		22.0 mm	Chevrolet Tras. Der. Chevy Pick-Up 99-04
370384		22.0 mm	Chevrolet Tras. Izq. Chevy Pick-Up 99-04
3700900		19.0 mm 3/4"	Ford Tras. Izq. Der. Fiesta 98-08 , Fiesta Ikon 01-07, Ford Tras. Izq. Der. Ka 1.6Lts. 01-08 Sustituye al 370361 y 370366
3700901		22.2 mm 7/8"	Ford Lobo Tras. Izq 00-02
3700902		22.2 mm 7/8"	Ford Lobo Tras. Der 00-02
3700904		22.2 mm 7/8"	Ford Courier Tras. Izq. Der. 01-09
3700905		19.0 mm 3/4"	Chrysler Tras, Izq. Der. Stratus 95-00, con mamelon redondo para fijar en platoporta balatas
3700908		19.0 mm 3/4"	Fiat Palio Adventure 04-11, Ford Eco Sport 04-10, Ford Fiesta 03-10, Tras IzqDer 04-08
3700912		22.2 mm 7/8"	Renault Kangoo 04-09 Tras Izq Der
3700913		22.2 mm 7/8"	Peugeot Partner 1.6L 04-09 Tras Izq Der
3700914		17.4 mm 11/16"	Pontiac Matiz Tra Izq Der 04-11
3700915		22.2 mm 7/8"	Chevrolet Malibu 05-08 Tras Izq Der
3700916		22.2 mm 7/8"	Chevrolet Tornado 04-08
3700917		17.4 mm 11/16"	Hyundai H-100 Chasis, Van, Wagon 06-11 Tras Izq
3700920		17.4 mm 11/16"	Hyundai H-100 Chasis, Van, Wagon 06-11 Tras Der

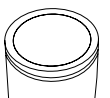



CILINDRO DE RUEDA			
No. PARTE LUSAC	No. PARTE RAYBESTOS	DIAMETRO	APLICACIÓN
3700921		22.2 mm 7/8"	Hyunday H-100 Diesel Van
3700922		22.2 mm 7/8"	Hyundai i10 12-14, Dodge Attitude 07 Nacional, Hyuindai Accent 07 USA TrasIzq Der
3700923		19.05mm 3/4	Chevrolet Sonic 13-15 tras izq Der
3700924		22.23 mm 7/8	Mitsubishi L-200 Der 07-11
3700925		22.23 mm 7/8	Mitsubishi L-200 Izq 07-11
3700926		22.2 mm 7/8"	Toyota Hilux 06-12 Tras izq der
3700927		19 mm 3/4	Toyota Yaris Hatchback 01-05 Tras izq der
3700928		20.64 mm 13/16	Peugeot 206 00-09 Tras Der
3700929		20.64 mm 13/16	Peugeot 206 00-09 Tras Izq
37009016		22.2 mm 7/8"	Hyundai H-100 03-06 Tras Der
37009017		22.2 mm 7/8"	Hyundai H-100 03-06 Tras Izq
37009018		20.6 mm 13/16"	Ford Ranger Argentina 01-07 Tras der
37009019		20.6 mm 13/16"	Ford Ranger Argentina 01-07 Tras Izq
370018RL		17.8 mm 45/64"	Chrysler Tras. Izq. Der. i10 12-14, Atos 01-12, Verna 04-06, Attitude 06-07
41100B96		25.4 mm 1"	Nissan Tras. Sup Der. Pick-up 720 81-88. USA
41101B96		25.4 mm 1"	Nissan Tras. Inf. Der. Pick-up 720 81-88. USA
41102B96		25.4 mm 1"	Nissan Tras. Sup Izq. Pick-up 720 81-88. USA
41103B96		25.4 mm 1"	Nissan Tras. Inf. Izq. Pick-up 720 81-88. USA
4410000Q		17.4 mm 11/16"	Nissan Tras. Izq. Der. Platina 02-08, Renault Clio 02-08
441004Z0	WC370141	17.4 mm 11/16"	Nissan Tras Izq. Der. Sentra XE & GXE 1.8L 00-01
441007Z0	WC370060	22.2 mm 7/8"	Nissan Pathfinder XE 99-01, XTerra 00-07, Frontier 03-04, NP300 Diesel 09-11.Tras Izq.
441007Z8	WC370060	22.2 mm 7/8"	Nissan Pathfinder XE 99-01, XTerra 00-07, Frontier 03-04, NP300 Diesel 09-11.Tras Der.
44100F40		23.8 mm 15/16"	Nissan Tras. Izq. Der. NP300 Gasolina 09-12 Nacional, Nissan Pick Up. D21 86-89, Nissan Trk. Pathfinder 93-95 USA
44100U48		22.2 mm 7/8"	Nissan Datsun Sedan 710 74-78 USA. Tras
WC37866		3/4"	Dodge Colt 91-94, Eagle Summit 91-95, Mazda 2 11-13, Mitsubishi Expo LRV 92-94, Plymouth 91-94
WC370141		11/16"	Nissan Honda Insight 00-06, Nissan Sentra 01-02

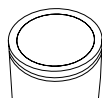



CILINDRO MAESTRO			
No. PARTE LUSAC	No. PARTE RAYBESTOS	DIAMETRO	APLICACIÓN
661	MC661	38.1 mm 1-1/2"	I.H.C Camión 41-69, Mack 46-63, Red 46-62.
785	MC785	38.1 mm 1-1/2"	Chrysler Dodge Camioneta 300 al 700 57-58, 500, 600 1957-58 700, 800, 41-58
1050	MC1050	26.9 mm 1-1/16"	Ford 39-48 Camioneta 39-56
1251	MC1251	44.4 mm 1-3/4"	Chevrolet Camión 500 44-49
2796	MC2796	25.4 mm 1"	VAM Classic 55-57, American 58-61
3434	MC3434	25.4 mm 1"	Chevrolet Early 40-56 Chevrolet Autos 35-52 Camioneta 38-50 Corvette 53-62
3573	MC3573	28.5 mm 1-1/8"	Dina Camioneta 78-80, Ford Camioneta 67-68, VAM Classic 41-54
4572	MC4572	31.7 mm 1-1/4"	Ford Camión P-350, P-400 61-66
9221	MC9221	31.7 mm 1-1/4"	Chevrolet Camión 40, 400, 4000 52-54
14019	MC14019	26.9 mm 1-1/16"	Ford Camión 3/4 1 Ton. 53-56
14021	MC14021	31.7 mm 1-1/4"	Ford Camioneta F-250, F-350 46-56
21680	MC21680	28.5 mm 1-1/8"	Chevrolet Camión Serie 3100 al 3800 55-69
22975	MC22975	26.9 mm 1-1/16"	Ford Camioneta F-100, F-200, F-350 57-60
22978	MC36177	44.4 mm 1-3/4"	Ford Camión F-700 68-72, F-500 70-72 USA
27304	MC27304	38.1 mm 1-1/2"	Chrysler Dodge 500,600, 59-77, D-700, 800 59-71, Ford F-500 73-77, F-600, 700 61-76, B, F-500 70-77
32839	MC36066	28.5 mm 1-1/8"	Chrysler Dodge D100 59-68, Camión Varios 59-77
32900	MC32900	25.4 mm 1"	Ford 52-66, Mustang 64-66, VAM American Classic 58-59
36482	MC36482	19.0 mm 3/4"	Nissan 510 67-72, Nissan 200SX 77-79, Nissan 610 71-72 Nissan 710 , 74-77 Nissan B210 74-78USA
39087	MC39087	17.4 mm 11/16"	Nissan Estaquitas 72-86
39153	MC39153	20.6 mm 13/16"	Nissan 210 79-82 , Nissan 510 78-81, Maxima 77-80 USA
39210	MC39210	24.0 mm	Chevrolet Calais, Century, Cutlass, El Camino, Grand Prix, LeMans, Malibu, Monte Carlo, Regal 81,Riviera , Toronado 79-81, USA
39276	MC39276	22.2 mm 7/8"	Nissan Camioneta Estaquitas 87-03 Pick Up Doble Cabina 82-90 (Cilindro Tokico)
39297	MC39297	15.8mm/22.2mm	Volvo 240 77-87, Volvo 260 76-82 Conexión lado Izquierdo USA
39298	MC39298	15.8mm/22.2mm	Volvo 240 75-93 , Volvo 260 76-82, Volvo Bertone 80-81, Volvo DL/GL 80-88, Volvo GLE, Coupe,760 80-82, Volvo GLT Series 81-84, Volvo GT Series 80 Conexión lado Derecho USA
39308	MC39308	30 mm	Chevrolet Blazer 91 Nacional, Caprice 81-85, GM G20, G25 83-95, GM. C10 Suburban 81-86, GM C10, C15 Pickup 81-86, GM C20 Suburban 82-86, GM C20, C25 Pickup 82-86, GM K10 Suburban 81-86, GM K10, K15 Pickup 81-86 , GM K20 Suburban 81-86, GM K20, K25 Pickup 81-86, USA
39319	MC39319	22.2 mm 7/8"	Nissan Maxima 82-84 USA
39330	MC39330	29.0mm/40.0mm	Chevrolet G10 81-84, GM G20 81-84, GM P20 81-84, USA
39348	MC39348	23.8 mm 15/16"	Toyota Pick-up 80-83 USA
39355	MC39355	25.4 & 36.0mm	Chevrolet Cadillac Eldorado 82-85, Seville 82-85, Oldsmobile Toronado 82-85 USA
39364	MC39364	22.2 mm 7/8"	Ford Courier 81-82, Mazda B2000 80-82 USA
39385	MC39385	24.0mm/31.7mm	Chevrolet Camaro con Tambor Trasero 82-83, Firebird con Tambor Trasero 82-83 USA
39388	MC39388	23.8 mm 15/16"	Ford Bronco II 84-85, Ford Ranger 83-85 USA
39403	MC39403	23.8 mm 15/16"	Toyota Pick-up 76-78 USA
39406	MC39406	19.0 mm 3/4"	Nissan Hikari 88-92, Ninja Turbo 86-87, Samurai 81-82, y 84-87, Tsuru I 84-87, Tsuru II 88-92 (Cilindro Nabco)
39413	MC39413	28.6 & 40 mm	Chevrolet. Blazer 87-91, C10 Suburban 81-86, C10, C15 Pickup 81-86, C20 Suburban 81-86, C20,C25 Pickup 81-86 USA
39419	MC39419	23.8 mm 15/16"	Chrysler Concord 82-83 Nacional, Eagle 82-88 USA, Jeep Cherokee 84-89, Jeep Comanche 86-89, Jeep Sportwagon 84, Jeep Wagoneer 84-89, Jeep Wrangler 87-89 USA
39423	MC39423	20.6 mm 13/16"	Toyota Corolla 80-82 USA
39426	MC39426	20.6 mm 13/16"	Honda Accord 82-85, Honda Civic 84-87, Honda CRX 84-87, Honda Prelude 83-87 USA
39453	MC39453	22.2 mm 7/8"	Isuzu Pickup 84-87, Trooper II 84-86 USA
39454	MC39454	20.6 mm 13/16"	Toyota Tercel 83-84 USA
39458	MC39458	20.6 mm 13/16"	Toyota Corolla 83 USA
39486	MC39486	22.2 mm 7/8"	Chevrolet Nova 85-88 Nacional, Toyota Corolla 84-87 USA
39498	MC39498	19.7 mm 45/64"	Ford Escort 83-90, Ford EXP 83-87, Lynx 83-87, Mercury LN7 83 USA
39499	MC39499	20.6 mm 13/16"	Mazda B2200 83-84 USA
39500	MC39500	20.6 mm 13/16"	Toyota 4Runner 84-88 USA
39509	MC39509	23.8 mm 15/16"	Nissan 720/D21 standard and heavy duty 2WD SRW 11/1982-10/1985, Nissan 720/D21 4WD 1/1983-10/1985 USA
39510	MC39510	23.8 mm 15/16"	Toyota Cressida with 7.5" booster 85-87 USA

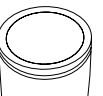



CILINDRO MAESTRO			
No. PARTE LUSAC	No. PARTE RAYBESTOS	DIAMETRO	APLICACIÓN
39518	MC39518	23.8 mm 15/16"	Toyota Pickup 85-88 USA
39540	MC39540	23.8 mm 15/16"	Ford Aerostar 86 USA
39547	MC39547	20.6 mm 13/16"	Chevrolet Spectrum 85-88 , GeoSpectrum 89, Isuzu I-Mark 85-89 USA
39553	MC39553	20.6 mm 13/16"	Volkswagen Corsar 83-84 Nacional, Volkswagen Quantum 85-88 USA
39555	MC39555	19.0 mm 3/4"	Nissan Hikari 88-92, Samurai 83-84, Tsuru I 84-87, Tsuru II 88-92, (Cilindro Tokico)
39565	MC39565	24.0mm/36.0mm	Chevrolet Olds 88 86, Cadillac Deville 86, Cadillac Fleetwood 86 USA
39566	MC39566	28.6 & 40 mm	Chevrolet Cadillac Cocours 94-96, Cadillac Deville 91-96 sin ABS
39567	MC39567	23.8 mm 15/16"	Ford Bronco II, Ranger 86-90 USA
39571	MC39571	24.0 & 36.0 mm	Chevrolet Pick Up S-10 95, Blazer 95
39592	MC39592	23.8 mm 15/16"	Nissan Pick Up Doble Cabina 91-92 Y 00-08
39593	MC39593	25.4 mm 1"	Nissan Pick Up D-21 91-96, Pick up 250 94-96
39594	MC39594	23.8 mm 15/16"	Nissan D-21 pickup Cil. Tokico 85-88, Nissan Pathfinder sin ABS 89 USA
39596	MC39596	23.8 mm 15/16"	Nissan D21 86-88, Nissan Pathfinder 89 USA
39599	MC39599	19.0mm/23.8mm	Nissan Nissan Pulsar 1.6L except.Doble Arbol de Levas 87-88 , Nissan Sentra, no wagon 86-88 USA
39612	MC39612	23.8 mm 15/16"	Toyota Camry 87-91 USA
39632	MC39632	25.4 mm 1"	Ford Bronco 87, Ford E150 87, Ford F150 87 USA
39635	MC39635	28.5 mm 1-1/8"	Ford F-250 94 y 96, F-350 94, P-350 89-91 y 94-96
39638	MC39638	24.0 mm	Chrysler Dodge Dakota 87-93 USA
39643	MC39643	22.2 mm 7/8"	Geo Spectrum 87-89 USA
39646	MC39646	28.5 mm 1-1/8"	Chevrolet Blazer Nevada 92-94, Suburban 88-94, C15 94, C-20, 25 88-91, C-20, C-25 y Cheyenne 92-94, Chrysler Ram 1500 94, Ram 2500 91-94, Ram Club Cab 91-93
39648	MC39648	20.6 mm 13/16"	Chevrolet Sprint 87-88, Suzuki Forsa 87-88 USA
39649	MC39649	31.7 mm 1-1/4"	Chevrolet Maxicab 91-93, C30,35 88-94
39651	MC39651	25.4 & 36.0mm	Chevrolet GM C1500 Pickup standard cab, standard chassis 88-91, GM K1500 Pickup 88-91,GM R10 Suburban 88, GM R15 Suburban 89-91, USA
39653	MC39653	22.2 mm 7/8"	Honda Accord 86-88, Honda Prelude 85-87 USA, Acura Integra 86-89 USA
39654	MC39654	22.2 mm 7/8"	Mazda Pickup 86-93 USA
39657	MC39657	22.2 mm 7/8"	Toyota Pick up 1/2 ton 2WD no turbo 86-88 USA
39658	MC39658	23.8 mm 15/16"	Toyota Pickup 85-88 USA
39666	MC39666	22.2 mm 7/8"	Toyota Camry 84-85 USA
39669	MC39669	23.8 mm 15/16"	Toyota Van 84-85 USA
39699	MC39699	20.6 mm 13/16"	Toyota 4 Runner 86-88, Toyota Pickup 86-88 USA
39704	MC39704	3/4" & 1"	Mercedes Benz E420 93-97, E400 93
39720	MC39720	19.0 mm 3/4"	Ford Festiva 88-93 USA
39736	MC39736	22.2 mm 7/8"	Chrysler Shadow GTS Turbo 89, Spirit 90-95.
39743	MC39743	22.2 mm 7/8"	Mazda 626 sin ABS 88-92 , Mazda MX6 sin ABS 88-92 USA
39745	MC39745	24.0 mm	Chevrolet Silhouette 91 Nacional, Chevrolet Pontiac Trans sport 90-91 USA
39748	MC39748	23.8 mm 15/16"	Chrysler Dodge D50, RAM 50, Dodge Raider 90-94 USA, Mitsubishi Montero Truck 89-91 y 90-95.USA
39757	MC39757	22.2 mm 7/8"	Honda Prelude 88-90 USA
39765	MC39765	25.4 mm 1"	Isuzu Amigo 2.6L 90-92 , Isuzu pick up con discos tras. 2WD y 4WD 87-90, Isuzu Pickup 2.6L or4WD 91-92, Isuzu Rodeo 91-92, USA
39772	MC39772	25.4 mm 1"	Ford Taurus 90-91
39786	MC39786	23.8 mm 15/16"	Isuzu Amigo 2.3L 89-93 , Isuzu Pickup 2 WD con Tambor trasero 88-92 USA
39791	MC39791	23.8 mm 15/16"	Nissan Pick Up D-21 99-01, Pick up doble cabina 97-00
39795	MC39795	23.8 mm 15/16"	Nissan Pathfinder 88-90 USA
39797	MC39797	23.8 mm 15/16"	Nissan Maxima Sin ABS. 92-93.
39799	MC39799	25.4 mm 1"	Nissan Maxima Con ABS. 92-93.
39805	MC39805	20.6mm/25.4mm	Nissan Pulsar NX 1.6 89-90, Nissan Sentra no wago 89-90 USA
39810	MC39810	22.2 mm 7/8"	Nissan 240SX 93 y 98 sin ABS
39812	MC39812	20.6 mm 13/16"	Geo Metro sin ABS. (96060617) 89-94, Suzuki Swift (51100.60B20) 89-94 USA
39853	MC39853	20.6 mm 13/16"	Chevrolet Pontiac Tempest 91. Geo Prizm 89-90, Toyota Corolla 88-89 USA
39862	MC39862	28.5 mm 1-1/8"	Chrysler Dodge Ram VAM 3500, Ram Wagon 3500 96-97.
39876	MC39876	33.3 mm 1-5/16"	Ford F-450 Super Duty 97-98, F-450 V8 Super Duty XL 99-02
39882	MC39882	23.8 mm 15/16"	Honda Accord 4 Lts S/ABS 96-97
39947	MC39947	22.2 mm 7/8"	Mazda 87-93 Mazda B series trucks con 4WD USA



CILINDRO MAESTRO			
No. PARTE LUSAC	No. PARTE RAYBESTOS	DIAMETRO	APLICACIÓN
39949	MC39949	22.2 mm 7/8"	Ford Escort con Trans. Automatica 91-92, Tracer 91-92 USA, Mazda 323 90-94, Mazda MX3 92-95, Mazda Protege 90-94, USA
39952	MC39952	29.0mm/40.0mm	Chevrolet Caprice 91-92, Estate Wagon 91, Roadmaster 88-92 USA
39953	MC39953	25.4 mm 1"	Ford Explorer XLS V6, XLT V8, Limited 91-94 Nacional, Ford Ranger 90-94, Mazda B2300 94, B300094, B4000 94, Navajo 91-94 USA
39954	MC39954	25.4 mm 1"	Chevrolet Oldsmobile 88 92
39955	MC39955	25.4 mm 1"	Chevrolet Cadillac Deville/Concours con ABS 94-96, Cadillac Deville con ABS 91-93, Oldsmobile-88 con ABS 92
39960	MC39960	22.2 mm 7/8"	Chevrolet Geo Tracker 93-95
39962	MC39962	25.4 mm 1"	Chevrolet Cadillac Deville 94
39970	MC39970	25.4 mm 1"	Honda Accord L4 Con ABS. 96-97 Nacional, Acura 2.5 TI 95-96, Acura 3.0 Cl 97, Acura Vigor 92-94 USA, Isuzu Oasis 96-97 USA
39976	MC39976	25.4 mm 1"	Nissan D21 92-95, Nissan Pathfinder 91-95 USA
39977	MC39977	25.4 mm 1"	Nissan D21 91-92 USA
39978	MC39978	25.4 mm 1"	Nissan Pathfinder con ABS. 91-95 USA
39979	MC39979	23.8 mm 15/16"	Nissan Pathfinder 90 USA
39980	MC39980	25.4 mm 1"	Jeep Wrangler 2.5 Lts. sin ABS 93-96.
39981	MC39981	23.8 mm 15/16"	Jeep Cherokee sin ABS 94
39989	MC39989	23.8 mm 15/16"	Isuzu Amigo 92, Isuzu Pickup 90-92 USA
39993	MC39993	22.2 mm 7/8"	Toyota Pickup, 89-93 USA
39996	MC39996	25.4 mm 1"	Toyota 4-Runner 89-94, Pickup 89-95, T100 Pickup 93-94 USA
40000	MC36006	25.4 mm 1"	VAM American, Classic 61, Chevrolet varios 59-66
42194	MC36127	38.1 mm 1-1/2"	Ford F600, B600 70-76
43207	MC34330	25.4 mm 1"	Chrysler Dodge Dart, Valiant 60-66
56193	MC36237	25.4 mm 1"	VAM American 71-73, Classic 70-73, Javelin 70, Gremlin 74-76, Rally 70-73, Jeep DJ-5 70-75, VAM American Classic Javelin 1964-70, Jeep Willys CJ5, 70-75, Wagoneer J-164 70-73.
64859	MC36355	28.5 mm 1-1/8"	Ford Camioneta F-300. F-350 67
64885	MC36239	25.4 mm 1"	Chevrolet Impala 70, C10 70-71.
64986	MC36233	25.4 mm 1"	Chevrolet Chevelle 70-72, Opel 70-72, Chevelle Malibu 70-72
71248	MC36251	25.4 mm 1"	Ford Mustang 71-73
71258	MC36221	25.4 mm 1"	Chrysler Coronet 71-74, Dart 70, Monaco 70, Super Bee 70, Valiant Duster 70, D-100 70-71.
71264	MC39468	25.4 mm 1"	Ford Camionetas F-100 68-72
73328	MC39495	25.4 mm 1"	Ford Maverick 70-73, Mustang 67-72. Galaxie 68-70, Falcon 67-68 incluye Barra de Empuje
73339	MC36359	28.5 mm 1-1/8"	Chrysler Dodge D-300 70, Tambor en las 4 Ruedas
73342	MC36280	28.5 mm 1-1/8"	Chevrolet Chevelle 70, C-10 71, Impala 70
75818	MC36307	26.1 mm 1-1/32"	Chrysler Super Bee 71-75. Monaco 71-73. D-100 72-73
76160	MC36361	28.5 mm 1-1/8"	Chevrolet Impala 71-72
78676	MC39467	25.4 mm 1"	Ford Crown Victoria 81, Grand Marquis 82, LTD 79-80
79772	MC36338	23.8 mm 15/16"	Chrysler Dart 71-73, Valiant Duster 71-73 (Rin 13")
80568	MC36461	28.5 mm 1-1/8"	Chrysler Dodge D-300 72-78, M-300 78
80903	MC36397	25.4 mm 1"	Ford Galaxie 73-74, LTD 75-78
83575	MC36399	25.4 mm 1"	Ford F-100 73-79
83578	MC36439	26.1 mm 1-1/32"	Chrysler Dart 73-76, Valiant Duster 73-76. Tambor Delantero y Tambor Trasero
84050	MC39177	25.4 mm 1"	Chevrolet C-10 74-80 Americana
85365	MC36440	23.8 mm 15/16"	Ford Maverick 74-77, Mustang 74-78
86130	MC36445	23.8 mm 15/16"	Ford Maverick 74-77, Mustang 75-78 con Booster
88783	MC36460	26.1 mm 1-1/32"	Chrysler Dodge Monaco 74-77, D-100 73-80, D-300 72-78
88787	MC36412	26.1 mm 1-1/32"	Chrysler Dart 76, Valiant Duster 76, Valiant Volare 77-79
90547	MC36272	17.4 mm 11/16"	Volkswagen Sedan 66-91
93065	MC35125	19.0 mm 3/4"	Volkswagen Camioneta Hormiga 76-78
96409	MC39147	20.6 mm 13/16"	Volkswagen Atlantic 81-87, Cilindro Fag, Caribe 78-87, Cilindro Fag y Ate, Caribe Gt 83-86, Cilindro Fag, Corsar 83-84, Cilindro Fag y Ate
96415	MC36275	19.0 mm 3/4"	Volkswagen Sedan 92-04 Sustituye al 96400
96431	MC39377	17.4 mm 11/16"	Volkswagen Caribe 77-79
97742	MC39809	26.9 mm 1-1/16"	VAM. Jeep Willys CJ-5 78
97934	MC39011	25.4 mm 1"	Ford F-150 80-86, P-350 77-78
97936	MC39368	26.9 mm 1-1/16"	Ford Camioneta E-200 86 USA

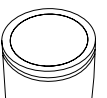



CILINDRO MAESTRO			
No. PARTE LUSAC	No. PARTE RAYBESTOS	DIAMETRO	APLICACIÓN
97938	MC39116	26.9 mm 1-1/16"	Ford F-350 77-79, P-350 77-78
98893	MC39031	23.8 mm 15/16"	VAM American 77-83, Gremlin 77-83, Pacer 79, Rally 77-83
98895	MC39178	28.5 mm 1-1/8"	Chrysler Dodge D-150 81-93. D-250 86-93, D-300 79-80, D-350 Microbus 81-90, W-150 85-87, RamVan1500 95, Ram Wagon 1500 95. Ram Charger 86-96, W-250 4 X 4 86-88
98896	MC36463	28.5 mm 1-1/8"	Chrysler Dodge W-250 4 X 4 86-93
98953	MC39017	33.3 mm 1-5/16"	Chevrolet C-30, C-35 76-89 Rodada Doble, C-30, C35 82-83 Rodada Sencilla, Panel P30 82-92 y 97-98
99084	MC39037	22.2 mm 7/8"	Ford Fairmont, Fairmont Vagoneta 78-81, Mustang 79-81 con Booster
99086	MC39174	22.2 mm 7/8"	Ford Fairmont, Fairmont Vagoneta 78-83, Mustang 79-81 sin Booster
99294	MC39034	26.1 mm 1-1/32"	Chrysler Cordoba 80-82, Dart 79-82, Le Baron 79-82, Magnum 81-82, Valiant Volare 78-81, Super Bee80
100560	MC36229	38.1 mm 1-1/2"	Chevrolet C40 70-72, C50 70-82, C60 70-82, C65 79-82
100760	MC36494	19.0 mm 3/4"	Ford Courier 72-75 USA
101252	MC39166	22.2 mm 7/8"	Chevrolet Malibu 79, Montecarlo 78-80 USA
101253	MC39016	23.8 mm 15/16"	Chevrolet Chevelle Malibu 79-81, Monte Carlo 81
101254	MC36306	28.5 mm 1-1/8"	Dina 1000 75-76 y 80-81 con Boster , VAM con Boster Wagoneer 77-80 Wagoneer J-164 74-76
101258	MC39028	28.5 mm 1-1/8"	Chevrolet C-10 77-80 Americana , Caprice 77-80, Willys Camioneta 77-80
101266	MC39075	31.7 mm 1-1/4"	Dina 3000, 3200 77-83, Chevrolet C30, C35 71-80
101268	MC39077	28.5 mm 1-1/8"	Chevrolet C-30,C-35 71
101269	MC39076	28.5 mm 1-1/8"	Dina Camioneta 1000 77-79, Chevrolet Camioneta C,G, K, P-10 y 15 76-80 USA
102418	MC39357	25.4 mm 1"	Ford Camioneta F-100, F-150 80-86 USA (sin Booster)
102421	MC39173	26.9 mm 1-1/16"	Ford F-350 80-83
103238	MC39309	34.0 mm	Chevrolet Microbus 94-00, Panel P30 94-98
103254	MC39461	38.1 mm 1-1/2"	Ford Camión B-600,F-600 80-85
104460	MC39328	28.6 & 40 mm	Chevrolet Caprice 81-82
104464	MC39324	31.7 mm 1-1/4"	Chevrolet Camionetas C, K, R 20 Americana, Suburban C-30 81-89 Americana
104466	MC39589	25.4 & 36.0mm	Chevrolet C-15 88-91
104471	MC39312	21.0 mm 53/64"	Ford Escort 81-83 (USA)
104516	MC39413	28.5 & 40.0 mm	Chevrolet Blazer Nevada 91 4X4 y 4X2, C15 82-87, C20, C25 79-87, Suburban 87, Dina Camionetas1000 81-83, 3000, 3200 80-83 , VAM Willy Camioneta 79-89, Wagoneer 81-86
105799	MC39570	24.0 mm	Chevrolet Montecarlo 82
105808	MC39350	21.0 mm	Ford Fairmont, Fairmont Vagoneta con Booster 82-83
105874	MC39367	25.4 mm 1"	VAM Jeep Willys CJ-5 79-83 sin Booster, Jeep Willys CJ-7 83
106437	MC39014	31.7 mm 1-1/4"	Ford F-350 73-76, P350 76
107050	MC39376	24.0 mm	Chevrolet Montecarlo 83-84, Cutlass Supreme 87-88 USA
107053	MC39375	22.2 mm 7/8"	Chevrolet Chevette 83-87 USA
108134	MC39451	21.0 mm	Chrysler Dart K 83-88, Dart K Guayin 83-88, Dart E 89, Le Baron K 83-87, Magnum K 83-88, NewYorker 85-99, Phantom 87-89, Serie 600 K 84-85, Shadow 89-94, Shadow GTS 90-91, Shadow Turbo92-94, Volare K 83-88
108145	MC39435	33.3 mm 1-5/16"	Chevrolet Camionetas C30, C35 84-87, Microbus 88-91 y 97-00, Panel P30 82-92 y 97-98
108151	MC39443	20.0 mm	Ford Topaz 84-94, Ghia 91-94
108168	MC39476	24.0 mm	Chrysler Imperial 91, Le Baron 92-95, New York 90-94, Phantom 90-94, Spirit Rt 91-95, Voyager 94-95, Grand Voyager 91-95, Town & Country 93-95
110887	MC39578	28.5 mm 1-1/8"	Chevrolet Camioneta G-10, G-20, P-25 86-90 USA
110917	MC39446	26.9 mm 1-1/16"	Ford Camioneta F-250 84-86 USA
110919	MC39445	28.5 mm 1-1/8"	Ford F-200 86, F-350 84-86
110983	MC39655	20.6 mm 13/16"	Volkswagen Golf A-2 C, Ci, Gi 87-92, Golf GTI A2 89-90, Jetta A2 87-91 Jetta A3 Ci, Gi, 97-99
112311	MC39531	21.0 mm 53/64"	Ford Cougar 85-86, Grand Marquis 83-84, Mustang 82-84, Thunderbird 85-86
112591	MC39542	22.2 mm 7/8"	Ford Taurus Vagoneta 88-89
114075	MC39628	23.8 mm 15/16"	Ford Camioneta Aerostar 87-89 USA
114079	MC39636	28.5 mm 1-1/8"	Ford F-200 87-91, F-250 92-93, F-350 84-93, P-350 Microbus 89-93
114081	MC39633	23.8 mm 15/16"	Ford Camioneta Ranger 87-89 USA
114190	MC39583	22.2 mm 7/8"	Chevrolet Cavalier 90-93 Cavalier Z24 91, Century 87-89
114192	MC39585	24.0 mm	Chevrolet Celebrity 87-89, Century 90-91, Cutlass 87-91, Cutlass Eurosport 87-91 Nacional, ChevroletPontiac Trans Sport 90 USA
114195	MC39584	24.0 mm	Chevrolet Cutlass 92-93 Century 92-93 Cutlass Eurosport 92-93
116402	MC39363	22.2 mm 7/8"	Chevrolet Celebrity 82, Citation 82



CILINDRO MAESTRO			
No. PARTE LUSAC	No. PARTE RAYBESTOS	DIAMETRO	APLICACIÓN
116403	MC39382	22.2 mm 7/8"	Chevrolet Century 83-86, Celebrity 83-84, Citation 83-85
116625	MC39647	24.0 & 36.0 mm	Chevrolet Camioneta C-10 C-15 88-92 USA
116702	MC39528	44.4 mm 1-3/4"	Chevrolet B600, F600 84-88, C-50 83-88, C-60 83-88, C-65 83-85
117583	MC39637	21.0 & 30.2 mm	Ford Cougar 87-88, Mustang 83-84, Thunderbird 87-88
120369	MC39634	26.9 mm 1-1/16"	Ford F-150 S/C/de Velocidad 87-04, F-200 87-91, F-250 92, Econoline Van E 150 95-96, Club Wagon V6 E 150 95-96, Lobo 97-99
120590	MC39767	31.7 mm 1-1/4"	Chevrolet Camioneta C-30, C-35 91-94, Microbus 92-93 y 97-00
120794	MC39773	23.8 mm 15/16"	Ford Thunderbird 89, Taurus Vagoneta 90-91
122572	MC39958	25.4 mm 1"	Ford Cougar 90-92, Cougar S/ABS 93-95, Cougar XR-7 90-94, Sable Vagoneta 94-95, Thunderbird 90-95
390004	MC390004	20.6 mm 13/16"	Nissan Sentra 92, Nissan NX 91-92, Sentra 93-94 USA
390006	MC390006	19.0 mm 3/4"	Nissan Tsuru III GS 93-14, Tsubame 93-04
390007	MC390007	23.8 mm 15/16"	Nissan Altima 01, Altima Sedan S, Altima Sedan SL, Altima Sedan SE 02-08 con ABS
390024	MC390024	25.4 mm 1"	Ford Grand Marquis 92-94 con ABS, Lincoln Town Car 91-94 con ABS, Sable Vagoneta 94-95 con ABS
390038	MC390038	25.4 mm 1"	Nissan 300 Zx 91-96, 300 Zx Convertible 93-95
390039	MC390039	23.8 mm 15/16"	Mazda MPV Van 89-95 USA
390044	MC390044	23.8 mm 15/16"	Honda Civic Con ABS 92-95, Honda Del Sol 95-97 USA
390056	MC390056	25.4 mm 1"	Chevrolet Geo Tracker 98-99 sin ABS
390060	MC390060	20.6 mm 13/16"	Seat Ibiza 01-05, Toledo 01-05, Volkswagen Golf A3 CL, GL. 95-96, Golf A3 GLS 94-96, Golf Cabrio A3 96, Golf GTI A3 93-96, Jetta A2 88-92, Golf GTI A 2 91-92, Jetta A2 GLI 90-92, Jetta GLS A3 94-96
390063	MC390063	29.0mm/40.0mm	Chevrolet Astro Van 90-94, GMC Safari Van 90-94 USA
390071	MC390071	25.4 mm 1"	Jeep Gran Cherokee con ABS 4X2 93-94, Jeep Wrangler con ABS 93-95
390096	MC390096	26.9 mm 1-1/16"	Chrysler Dodge Viper 93, Ford Aerostar 92-95
390110	MC390110	23.8 mm 15/16"	Chrysler Concorde 93-97, Intrepid 94-97, New Yorker, LHS 94-97 (sin ABS), New Yorker LH (sin ABS) 94-97
390111	MC390111	23.8 mm 15/16"	Chrysler Concorde 93-97 con ABS, Intrepid 94-97, New Yorker LHS 94-97 (con ABS), New Yorker LH94-97 (con ABS)
390115	MC390115	25.4 mm 1"	Nissan Quest XE 97-02 Nacional, Mercury Villager 93-00 USA con ABS
390116	MC390116	25.4 mm 1"	Nissan Quest XE 97-98 Nacional, Mercury Villager 93-00 USA Sin ABS.
390117	MC390117	28.5 mm 1-1/8"	Ford P-350 Microbus 92 Nacional, Ford E-250 92, E-350 92 USA
390118	MC390118	25.4 mm 1"	Nissan Pick Up D-21 92-98, King Cab 95-00.
390126	MC390126	26.9 mm 1-1/16"	Ford Cougar 93-95, Lincoln Mark VIII 94-96, Thunderbird 96
390139	MC390139	23.8 mm 15/16"	Nissan Altima 96-00.
390140	MC390140	23.8 mm 15/16"	Nissan Altima SE 96-00 sin ABS
390156	MC390156	23.8 mm 15/16"	Mitsubishi Montero Sport; 93-03 Mitsubishi Montero 92-00 Sin ABS USA
390161	MC390161	23.8 mm 15/16"	Chevrolet Luv 2.3 Lts 97-05 Nacional, Isuzu Amigo 93, Isuzu Pickup 93-95 USA
390174	MC390174	22.2 mm 7/8"	Chevrolet Cavalier 92-94, Cavalier Z24 92-94
390175	MC390175	24.0 mm	Chevrolet Buick Regal 94-96
390176	MC390176	24.0 mm	Chevrolet Grand Prix GT, GTP, SE 97
390178	MC390178	24.0 mm	Chevrolet Lumina Apv 95-96, Silhouette 92-95
390179	MC390179	24.0 mm	Chevrolet Century 94-96, Cutlass 94-96, Cutlass Eurosport 94-96
390182	MC390182	28.5 mm 1-1/8"	Ford Econoline Van E-250 97, Club Wagon V8 E-250 95-96, Econoline Club Wagon V8 E-350 95-96
390183	MC390183	26.9 mm 1-1/16"	Ford Econoline Club Wagon V6 E-150 XL 95-96, F-150 94-95 y 97-04, Lobo 97-04. C/C. Vel.
390184	MC390184	28.5 mm 1-1/8"	Ford F-250 95, F-350 94, P-350 94-96 C/ Control de Vel Doble Rodada
390185	MC390185	26.9 mm 1-1/16"	Ford Mustang GT 94-95
390186	MC390186	25.4 mm 1"	Chevrolet Bonneville 94-95, Oldsmobile 88 94-95
390188	MC390188	24.0 mm	Chrysler Dodge Dakota con frenos de poder 96
390190	MC390190	31.7 mm 1-1/4"	Chrysler Dodge Ram 2500 94, Ram 3500 94
390204	MC390204	21.0 mm 53/64"	Chrysler Neon 95-96. Disco Tambor sin ABS
390205	MC390205	21.0 mm 53/64"	Chrysler Neon 95-96 Freno de Tambor Trasero con ABS
390213	MC390213	22.2 mm 7/8"	Chrysler Neon 95-99 Disco / Disco sin ABS
390214	MC390214	25.4 mm 1"	Chevrolet Camaro V6 3.4 Lts 95-97, Firebird Trans-Am 94-97.
390215	MC390215	22.2 mm 7/8"	Chrysler Dodge Neon D/D con ABS 95-99.
390216	MC390216	26.9 mm 1-1/16"	Ford Aerostar 91
390217	MC390217	23.8 mm 15/16"	Ford Ghia 94, Mustang Cobra 94-95 USA

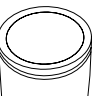



CILINDRO MAESTRO			
No. PARTE LUSAC	No. PARTE RAYBESTOS	DIAMETRO	APLICACIÓN
390224	MC390224	23.8 mm 15/16"	Ford Escort GT 94-95, Escort, Escort LX 94-96, Escort Vagoneta 94-96, Transmision Automática
390225	MC390225	23.8 mm 15/16"	Ford Escort, Escort LX 94-96, Escort Vagoneta 94-96, Escort GT 94-95 Transmision Manual
390226	MC390226	25.4 mm 1"	Ford Contour 96-97, Mystique 95-96 sin ABS
390231	MC390231	23.8 mm 15/16"	Nissan 240 Sx 93 y 98 Con ABS
390233	MC390233	23.8 mm 15/16"	Nissan Infiniti I 30 98-99. Maxima 95-99. con ABS
390234	MC390234	23.8 mm 15/16"	Nissan Maxima Cil Nabco 95-99, Sentra 1.8 Lts XE, Sentra 1.8 Lts GXE 01-06, Sentra 2.0 Lts SE 01, Sentra 2.5 Lts SE-R 02-06 y 08
390235	MC390235	23.8 mm 15/16"	Nissan Maxima 95-00 S/ABS Tokico
390236	MC390236	26.9 mm 1-1/16"	Toyota 4 Runner 94-95, Toyota Pickup 94 USA
390239	MC390239	23.8 mm 15/16"	BMW 325i 95-97
390244	MC390244	13/16" & 1"	BMW M3 95-99
390245	MC390245	25.4 mm 1"	Ford Lincoln Town Car ABS 95-96, Grand Marquis 95
390248	MC390248	26.9 mm 1-1/16"	Ford Windstar GL, LX 95-97 sin Control de Tracc.
390251	MC390251	22.2 mm 7/8"	Chrysler Breeze Rin 14" 96, Cirrus 96-00, Sebring R/T 97, Stratus 95-02 sin ABS
390253	MC390253	44.4 mm 1-3/4"	Gmc 60 Series 88-97
390254	MC390254	22.2 mm 7/8"	Chrysler Cirrus 96-97, Stratus 96-97 (con ABS), Sebring R/T Rin 15" ABS 97
390256	MC390256	25.4 mm 1"	Ford Lincoln Town Car 95-96, Grand Marquis 95-96 sin ABS
390257	MC390257	31.7 mm 1-1/4"	Chevrolet C-15 95-99 C-20, C-25 y Cheyenne 95-01, Chrysler Ram 1500 4X2, 4X4 97, Ram 2500 95-97, Club Cab Larami 4X2, 4X4 (7,500 Lb) 95-97
390258	MC390258	31.7 mm 1-1/4"	Chrysler Ram 3500 4X2, 4X4 95-97, Ram 4000 95-97
390259	MC390259	28.5 mm 1-1/8"	Chevrolet Silverado 95-99, C-15 95-99, C-20 C-25 y Cheyenne 95-01, Sonora 00-02, Suburban 95-00, Chrysler Ram Runner V-10 96, Ram 1500 95-96, Ram 2500 y Club Cab 95-96 Nacional, Cadillac Escalade 99-00, GMC Tahoe 00, Yukon 95-00 USA
390267	MC390267	25.4 mm 1"	Chevrolet Cadillac de Ville 95-99, Cadillac El Dorado 95-97, Cadillac Seville 94-04, Pontiac Bonneville 96-99
390268	MC390268	26.9 mm 1-1/16"	Ford Explorer XLS V6, XLT V8, Limited 95-97, Ranger Tambor de 9" 96-97 Con Control de Velocidad Nacional, Ford Ranger 95, Mercury Mountaineer 97, Mazda B2300 95-97, B3000 95-97, B4000 95-97 USA
390269	MC390269	26.9 mm 1-1/16"	Ford Explorer XLS V6, XLT V8, Limited 95-97, Ranger Tambor de 10" 96-97 Sin Control de Velocidad Nacional Ford Ranger 95, Mercury Mountaineer 97, Mazda B2300 95-97, B3000 95-97, B4000 95-97 USA
390271	MC390271	22.2 mm 7/8"	Seat Cordoba 2.0 Lts 01-02 Disco Tambor sin ABS, Seat Ibiza 1.6 Lts 01-02 Disco Tambor sin ABS, Volkswagen Derby 01-09, Golf A3 CL, GL. 1.8 Lts 93-94, Golf A3 GLS 2.0 Lts 93-94, Golf A3 GTI VR6 95-99, Golf Cabrio A4 2.0 Lts 02. Golf GTI A3 93-96, Jetta A3 CL, GL, 1.8 Lts 93-96 Jetta GLS A3 2.0 Lts 93, Jetta A3 VR6 95-99. Passat VR6 2.8 Lts 96-97, Volkswagen Van 06-09
390275	MC390275	23.8 mm 15/16"	Chrysler Grand Voyager Rin 15" y 16" con ABS sin Control de Tracc. 96, Town & Country Rin 14" 96, Voyager Rin 14" sin Control Tracc. 96-00 Nacional, Caravan 96-00 USA
390276	MC390276	22.2 mm 7/8"	Chevrolet Achieva 96-98, Beretta 96, Corsica 96, Grand Am 96-98 Skylark 96-98 USA
390277	MC390277	22.2 mm 7/8"	Chevrolet Cavalier 95-99, Cavalier Z24 95-96, Sunfire 97-99
390278	MC390278	31.7 mm 1-1/4"	Chevrolet C-30, C-3500, C3500 Heavy Duty 96-02, C-36 01-02 Heavy Duty, Panel P-30 01-03
390279	MC390279	31.7 mm 1-1/4"	Chevrolet C-30, C-35 95, C35, C3500, C3500 HD 96-00, Panel-30 96-00 Nacional, Sierra 3500 99-00 USA
390285	MC390285	25.4 mm 1"	Toyota Tacoma Sin ABS 95-01 USA
390289	MC390289	25.4 mm 1"	Toyota Tacoma C on ABS 4X4 95-01 USA
390291	MC390291	25.4 mm 1"	Toyota Avalon 95-96, Toyota Camry 95-01, Toyota Solara 99 Sin ABS USA
390296	MC390296	25.4 mm 1"	Toyota 4 Runner 94-95 Toyota T100 95-98 USA
390298	MC390298	25.4 mm 1"	Ford Sable 96
390299	MC390299	25.4 mm 1"	Ford Lincoln Town Car 97, Grand Marquis 96 ABS
390303	MC390303	25.4 mm 1"	Jeep Cherokee Sport 98-01, Jeep Grand Cherokee con ABS 4X2, 4X4 95-98
390308	MC390308	25.4 mm 1"	Ford Mustang GT 4.6 Lts. 96-97
390309	MC390309	25.4 mm 1"	Ford Mustang Cobra 4.6 Lts. 97
390310	MC390310	25.4 mm 1"	Jeep Wrangler 4.0 Lts 96
390313	MC390313	26.9 mm 1-1/16"	Ford Explorer XLS V6, XLT V8, Limited 95-97 sin Control de Velocidad
390314	MC390314	26.9 mm 1-1/16"	Ford Explorer XLS V6, XLT V8, Limited 95-97 con Control de Velocidad
390317	MC390317	20.6 mm 13/16"	Nissan Sentra 1.6 Lts GST, Sentra GSX 96-00 Sin ABS Tokico
390318	MC390318	22.2 mm 7/8"	Nissan Sentra 2.0 Lts sin ABS 96-00, Tsuru GSR 2000 2.0 Lts 93-96, Lucino GSE, GSR sin ABS 96-00



CILINDRO MAESTRO			
No. PARTE LUSAC	No. PARTE RAYBESTOS	DIAMETRO	APLICACIÓN
390319	MC390319	22.2 mm 7/8"	Nissan Sentra 1.6 ABS 96-00, Sentra 2.0 Lts ABS 96-00, Lucino GSE, GSR ABS 96-00
390320	MC390320	24.0 & 36.0 mm	Chevrolet Blazer 96-97, S-10 Pick Up 96-97
390321	MC390321	31.7 mm 1-1/4"	Chevrolet Astro Mini Van 96-03, Safari Mini Van 96-03 USA
390323	MC390323	22.2 mm 7/8"	Honda Civic Ex 97-01, Civic SI 99-01. sin ABS
390325	MC390325	50.8 mm 2"	Gmc 70 Series 88-00
390326	MC390326	23.8 mm 15/16"	Chevrolet Geo Tracker 98-99 sin ABS 4 Ptas
390328	MC390328	20.6 mm 13/16"	Honda Civic T. Estandar 97-01, 4 Ptas. sin ABS
390329	MC390329	26.9 mm 1-1/16"	Ford Windstar 96-98 con C/Tracc
390331	MC390331	22.2 mm 7/8"	Honda Civic 1500,1600 LX,GX 96-98 USA
390335	MC390335	23.8 mm 15/16"	Chevrolet Geo Tracker con ABS 98-99
390336	MC390336	31.7 mm 1-1/4"	Ford Expedition XLT. Eddie Bauer 97-01, F-150 V6 00-04, F-250 01-02, F-250 Super Duty D/D 01-02,F-350 95-96.F-250 Lobo 00-04. sin/ C. Vel. Lincoln Navigator 98-02 D/D sin C.de Vel.
390337	MC390337	31.7 mm 1-1/4"	Ford Lincoln Navigator D/D 98-02, Expedition XLT, Eddie Bauer 97-06, F150 00-04, F-250 97-02, F-250 Super Duty 98-02, F-350 95-98, F-350 XL V8 Triton Rodada Do-ble 99-03, F-350 Super Duty 99- 07, F-250 Lobo 00-04, con C/ de Vel. P-350 97.
390338	MC390338	31.7 mm 1-1/4"	Ford F-250 01-02, F-250 Super Duty 01-02, Disco Tambor con C/Vel.
390339	MC390339	31.7 mm 1-1/4"	Ford F-250 97-02, F-350 97-98 Rodada Sencilla, Lobo 1500 00, P-350 97.Disco Tambor sin C/Vel.
390342	MC390342	25.4 mm 1"	Nissan Pathfinder XE 4X4 97-01
390343	MC390343	25.4 mm 1"	Nissan Pick Up D-21 99-01
390344	MC390344	25.4 mm 1"	Nissan Pick-Up D 21 4WD STD 96-97
390347	MC390347	25.4 mm 1"	Nissan Pathfinder XE 2X4 97-01, Pick Up Doble Cabina 97-00
390351	MC390351	22.2 mm 7/8"	Toyota RAV4 96-02 Sin ABS USA
390362	MC390362	25.4 mm 1"	Chevrolet Oldsmobile Intrigue w/Active Brake Control. (JL4) 00-02 USA
390363	MC390363	28.5 mm 1-1/8"	Chevrolet G-15 98-02, Express 1500, Express Cargo Van 1500 98-02, Express 2500, Express CargoVan 2500 99-02
390364	MC390364	31.7 mm 1-1/4"	Chevrolet G-30 Express 3500 y Express Cargo Van 3500 97-03, G-30 97-03
390367	MC390367	25.4 mm 1"	Toyota 4 Runner Con ABS 96-01 USA
390368	MC390368	25.4 mm 1"	Toyota 4 Runner Sin ABS 96-01 USA
390370	MC390370	25.4 mm 1"	Ford Sable 97-04, Sable Vagoneta 96-97
390371	MC390371	25.4 mm 1"	Chevrolet Venture APV 97-99, C/ABS Nacional, Montana 99 USA
390377	MC390377	23.8 mm 15/16"	Chrysler Grand Voyager Rin 15" y 16" 97-00, Town & Country Rin 14" con Con- trol de Tracc. 96-00,Voyager con Control Tracc. 97-00. Ram 4000 05-06
390378	MC390378	25.4 mm 1"	Jeep Wrangler, Jeep Wrangler Sahara 97-02, Jeep Wrangler Unlimited, Jeep Wrangler Rubicon 03-06 Nacional, Chysler Dodge Dakota 97-98 USA
390386	MC390386	25.4 mm 1"	Chevrolet Malibu LX, 97-01y 05, Malibu LS 97-01 y 05, Grand Am ABS 99-00
390389	MC390389	31.7 mm 1-1/4"	Ford Econoline Van E 250 ABS 98-99, Econoline Van E-350 98-99, Club Wagon V8 E-250 Chateau 9596 y 98-00, Econoline Wagon V8 E 250 Chateau 99-00
390392	MC390392	28.5 mm 1-1/8"	Ford Econoline Van E 150 97-98 y 01, Econooline Wagon 01, Club Wagon E-150 V6 sin Control deVelocidad 97-01, Econoline Wagon V6 E-150 97-98 y 01 sin Control de Velocidad
390393	MC390393	28.5 mm 1-1/8"	Ford Econoline Van E-150 97-01, Econoline E-150 Wagon 99-01, con Con- trol de Velocidad, EconolineClub Wagon V6 E-150 97-01
390394	MC390394	31.7 mm 1-1/4"	Ford Econoline Van E-150 99-00, Econoline Wagon E-150 99-00, Econoline Van E-250 98-99,Econoline E-350 98, Club Wagon V8 E 250 Chateau 95-96, Club Wagon V8 E-350 95-96, Club Wagon V8 E-350 Chateau 95-96 y 98-00, con C/ de Traccion
390395	MC390395	25.4 mm 1"	Ford Windstar GL, LX 98 sin Control de Tracción
390398	MC390398	26.9 mm 1-1/16"	Ford Lincoln Aviator 03-05, Explorer XLS V6, XLT V8, Limited 98-08, Ran- ger 01-06 Con Control deVelocidad Nacional, Mercury Mountaineer 03-08, Mazda B2300 01-08, B2500 98-01, B3000 01-07,B4000 01-08 USA
390399	MC390399	26.9 mm 1-1/16"	Ford Explorer XLS V6, XLT V8, Limited 98-05, Explorer Sport 01-03, Ran- ger 98-05 Sin Control deVelocidad, Nacional, Mercury Mountaineer 98,Mazda B2300 01, B2500 98-01, B3000 01,B4000 01 USA
390400	MC390400	26.9 mm 1-1/16"	Ford Explorer XLS V6, XLT V8, Limited 98-02, Explorer Sport 01-03, Ranger 98-04 Conaccionamiento electronico y Control de Velocidad Nacional, Ford Blac- kwo0 02, Mercury Mountaineer 98, Mazda B3000 98-00, B4000 98-00 USA
390401	MC390401	25.4 mm 1"	Chevrolet Grand Prix GT, GTP, SE 98-01, Impala 00-04, Monta- na 05, Venture APV 00-04 Nacional, Montana 99-04 USA
390408	MC390408	26.9 mm 1-1/16"	Chrysler Dodge Durango 98
390417	MC390417	23.8 mm 15/16"	Honda Accord Sedan 4 Cil. 98-02. Accord Sedan 6 Cil. 98-00. S/ABS
390418	MC390418	25.4 mm 1"	Honda Accord Sedan 4 Cil. 98-02. Accord Sedan 6 Cil. 98-02. C/ABS

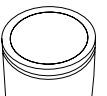



CILINDRO MAESTRO			
No. PARTE LUSAC	No. PARTE RAYBESTOS	DIAMETRO	APLICACIÓN
390425	MC390425	22.2 mm 7/8"	Chrysler Cirrus 98-00. Stratus 98-02 Con ABS
390426	MC390426	31.7 mm 1-1/4"	Chrysler Ram Charger 99-01, Ram Runner V-10 97, Ram 1500 97-01, Ram 2500 y Club Cab Larami 97-01, Ram 3500 98-02. Ram 4000 98-01
390427	MC390427	25.4 mm 1"	Chevrolet Blazer 98-01, S-10 Pick Up 98-99
390430	MC390430	25.4 mm 1"	Ford Lincoln Town Car 97, Gran Marquis 97. con ABS
390432	MC390432	22.2 mm 7/8"	Volkswagen Golf A3 GTI 95-99, Golf A3 GTI VR6 95-99, Jetta A3 VR6 95-99, Passat VR6 96-97, Passat Vagoneta VR6 96-97 con ABS
390433	MC390433	25.4 mm 1"	Volkswagen Cabrio A4, 95-02, Volkswagen Golf A3 95-99, Volkswagen Jetta A3 96-99 Volkswagen Passat 96-97 Con ABS
390440	MC390440	23.8 mm 15/16"	Chrysler Concorde con ABS 01-02., Intrepid 98-01, 300 M 99-04
390441	MC390441	25.4 mm 1"	Nissan Frontier L-4 01-02. Frontier V-6 01-02.
390445	MC390445	25.4 mm 1"	Ford Grand Marquis 97-00 Lincoln Town Car 98-00 ABS sin C/ de Traccion
390447	MC390447	23.8 mm 15/16"	Ford Escort, Escort LX Trans. Aut. D/D sin ABS 97-01, Escort Vagoneta 97-99
390448	MC390448	23.8 mm 15/16"	Ford Escort, Escort LX 97-01, Escort Vagoneta 97-99, Transmision Automatica ABS.
390449	MC390449	23.8 mm 15/16"	Ford Escort, Escort LX 97-01 Trans. Man. D/D S/ABS
390450	MC390450	23.8 mm 15/16"	Ford Escort 97-01. Trans. Man. ABS
390451	MC390451	25.4 mm 1"	Nissan Altima 98-00 ABS Tokico
390463	MC390463	25.4 mm 1"	Ford Mystique 96-00, Contour 96-00 S/ABS
390465	MC390465	44.4 mm 1-3/4"	Mercedes Benz E280 07-08, E320 96-05
390479	MC390479	23.8 mm 15/16"	BMW Serie 3 328 I 97-00. Serie 3 Z3 96-02.
390483	MC390483	25.4 mm 1"	Nissan Infiniti Q45 Cil Tokiko 97-01
390488	MC390488	23.8 mm 15/16"	Mercedes Benz C230 97-99, C230 K 96-00, C280 95-00, C280 Vagoneta 98-99, SLK230 97-05
390491	MC390491	3/4" & 1"	Mercedes Benz E280 07-08, SL320 95-97, SL500 95-97
390500	MC390500	23.8 mm 15/16"	Audi A3 02-03, Audi TT 00-02, Volkswagen Beetle 2.0 Its 98-05, Beetle Turbo 1.8 Its 00-05, Beetle Cabriolet Turbo 1.8 Its 03-05, Golf GTI A4 2.0 Its S/ABS 00-05, Golf A4 2.0 Its S/ABS 00-06, Jeta 2.0 Its A4 00-08
390508	MC390508	23.8 mm 15/16"	Chrysler Dodge Durango 99-04, Viper 04 10 Nacional Dodge Dakota 99-04 USA
390514	MC390514	23.8 mm 15/16"	Ford Escort, Escort LX 97-01 Transmisión Std. D/T S/ABS
390515	MC390515	23.8 mm 15/16"	Ford Escort, Escort LX 97-01, Escort Vagoneta 97-99 Transmisión Aut. D/T S/ABS
390516	MC390516	31.7 mm 1-1/4"	Chrysler Ram Van y Ram Wagon 1500 96-03, Ram Van y Ram Wagon 2500, 96-02, Ram Van y Ram Wagon 3500 98-02, Gran Voyager sin Control de Tracc. 97-00. Town & Country 96-00, Voyager 97-00 sin Control de Tracc
390525	MC390525	25.4 mm 1"	Ford Mustang, GT V6 99-04 Sin Control de Tracc
390526	MC390526	33.3 mm 1-5/16"	Ford Econoline Van E-150 06-07, Econoline Van E-350 99 y 06-07, Econoline Van E-350 Diesel 06-07, Club Wagon V6 E-150 04-06, Club Wagon V8 E-250 99-04, Econoline Wagon Diesel 01 y 03 Club Wagon V8 E-350 XL 99-06, sin C/ de Velocidad, Escape 05-06.
390527	MC390527	26.9 mm 1-1/16"	Ford Mustang GT V8 98-04. sin ABS
390528	MC390528	26.9 mm 1-1/16"	Ford Mustang, GT, 99-04 Con control de tracción
390530	MC390530	34.9 mm 1-3/8"	Ford Excursion 01-05, F-250 99-04, F-350 Super Duty 99-06, F-450 V-10 99-06, F-450 V8 Diesel Super Duty 05-06, F-550 V-10 01-06, F-550 V8 Diesel 05-06. con Control de Vel.
390531	MC390531	34.9 mm 1-3/8"	Ford F-250 99-04, F-350 99-07, F-350 Super Duty 99-07, F-450 V10 99-06, F-450 V8 Diesel 05-06, F-550 V10 Super Duty 01-06, F550 V8 Diesel Super Duty 05-06 sin C/ de Velocidad
390534	MC390534	25.4 mm 1"	Chrysler Town & Country 96-00, Voyager 97-00 Grand Voyager 98-00 Sin control de Tracción Nacional, Chrysler Dodge Caravan 98-00 USA
390536	MC390536	26.9 mm 1-1/16"	Ford Econoline Van E-350 99, Club Wagon V8 E-250 97-04, Econoline Wagon Diesel 01 y 03. Club Wagon V8 E-350 XL 97-04 con Cont. de Vel.
390541	MC390541	25.4 mm 1"	Chevrolet Cadillac Escalade 02-03. Avalanche 02, Cheyenne 02-04, Silverado 1500 00-01 y 03-06. Silverado 2500 00-01 y 03-06.
390542	MC390542	37 mm	Chevrolet Cadillac Escalade 2X4 5.3 Lts 02-03, Avalanche 02, Silverado 1500 00-01 y 03-06, Cheyenne 02-04, Silverado 2500 00-01 y 03-06, Silverado 3500 96-00, Silverado 3500 Heavy Duty 96-02, Sonora 01-02, Suburban 1500 01-03, Suburban 2500 00-02, Humer H2 05-07
390546	MC390546	23.8 mm 15/16"	Chevrolet Tracker 99-04 Sin ABS
390550	MC390550	23.8 mm 15/16"	Honda Civic EX, SI C/ABS 99-01
390551	MC380551	26.9 mm 1-1/16"	Honda Odyssey 00-04 Nacional, Acura MDX 01-02 USA
390552	MC390552	25.4 mm 1"	Chevrolet Cadillac De Ville 00-04 Sin ABS
390553	MC390553	25.4 mm 1"	Ford Contour con ABS y Control de Traccion. 97-00
390555	MC390555	25.4 mm 1"	Ford Lincoln LS 00-07, Thunderbird 03-04, Jaguar S Type V6 01-05, Jaguar S Type V8 00-04
390556	MC390556	26.9 mm 1-1/16"	Honda Odyssey LX 00-04



CILINDRO MAESTRO			
No. PARTE LUSAC	No. PARTE RAYBESTOS	DIAMETRO	APLICACIÓN
390564	MC390564	25.4 mm 1"	Honda Accord V6 S/ABS 01-02
390565	MC390565	50.8 mm 2"	Gmc 50 Series 98-00, Gmc 60 Series 98-00
390569	MC390569	25.4 mm 1"	Ford Lincoln Town Car 98-00, Grand Marquis 98-00, con Cont. de Trac.
390570	MC390570	26.9 mm 1-1/16"	Ford Windstar LX, SE, SEL y Limited. 99-00. D/T S/Cont. Trac.
390571	MC390571	25.4 mm 1"	Chevrolet Blazer 00-01, S-10 Pick Up 00-04
390573	MC390573	26.9 mm 1-1/16"	Ford Windstar 99-01 Con control de tracción
390577	MC390577	23.8 mm 15/16"	Chrysler PT Cruiser 01-05. PT Cruiser Turbo Convertible 03-05. Dodge Neon D/D C/ABS 00-05, Neon SRT-4 04-05,
390579	MC390579	22.2 mm 7/8"	Chrysler Dodge Neon 00-05 Disco Tambor Sin ABS
390580	MC390580	33.3 mm 1-5/16"	Ford E-350 99 USA
390581	MC390581	25.4 mm 1"	Ford Windstar LX, SE, SEL y Limited D/D con ABS y control de tracción 99-03
390582	MC390582	25.4 mm 1"	Ford Windstar LX, SE, SEL y Limited 99-03. S/Cont. Trac.
390584	MC390584	25.4 mm 1"	Nissan Quest sin ABS 99-02 Nacional, Ford Mercury Villager sin ABS 99-00, USA.
390590	MC390590	50.8 mm 2"	Ford Excursion 01-04. Sin C. de Vel.
390592	MC390592	34mm	Cadillac DeVille 00-05
390594	MC390594	13/16" & 15/16"	Volvo C-70 99-01, S-70 99-00. C-70 Vagoneta 99-04, V 70 99-04 Con Control de Tracc.
390608	MC390608	25.4 mm 1"	Ford Sable 00-04
390613	MC390613	25.4 mm 1"	Audi A4 01, Audi S4 00-01, Audi A6 98-01, A6 Quattro 98-01, Audi A8 97-01. Audi A8 Quattro 98-05, Audi S8 01-02, Audi RS4 01, Volkswagen Passat 1.8 Lts y 2.8 Lts V6 00-01
390615	MC390615	25.4 mm 1"	Nissan Quest XE 01-02. Con ABS.
390618	MC390618	3/4" & 1"	Mercedes Benz E320 96-05, E430 99-02
390624	MC390624	3/4" & 15/16"	Mercedes Benz CLK320 98-03, CLK350, CLK350 Convertible 06-08
390632	MC390632	13/16" & 1"	BMW Serie 4 525i 01, Serie 5 528i 96-00 Con ABS, Serie 5 530i 01-03, Serie 5 540i 01-03, Serie 7 740i 98, Serie 7 750iL 98.
390633	MC390633	13/16" & 1"	BMW Serie 4 525i 02-03, Serie 5 528i 96-00 Sin ABS, 530i 01-03, 540i 01-03, M5 99-03, X5 00-01, Serie 7 740iL 99-01, 750iL 99-01
390636	MC390636	23.8 mm 15/16"	Porsche 911 Carrera 98-06, Boxer 97-06
390638	MC390638	23.8 mm 15/16"	Chrysler PT Cruiser 01-05. Dodge Neon 00-05. Neon SRT -4 04-05.
390639	MC390639	23.8 mm 15/16"	Nissan Infiniti I-30 00-01. Infiniti I-35 (No Sport) 02-04. Maxima 01-03.
390643	MC390643	23.8 mm 15/16"	Ford Focus 00-08 Sin ABS Sin Control de Traccion.
390645	MC390645	25.4 mm 1"	Chevrolet Impala S/ABS 00-04
390646	MC390646	22.2 mm 7/8"	Chevrolet Cavalier 2.2 Lts 00-04, Sunfire 00-02 y 04-05
390654	MC390654	25.4 mm 1"	Mitsubishi Montero Sport XLS 03-04. Con ABS
390655	MC390655	25.4 mm 1"	Mitsubishi Montero Sport XLS S/ABS 03-04
390660	MC390660	26.9 mm 1-1/16"	Chrysler Stratus 02-05 2 Pts ABS Coupe Sin Control de Tracc
390661	MC390661	26.9 mm 1-1/16"	Chrysler Stratus 03-06. Sin ABS, Mitsubishi Eclipse 03-05. Galant 03.
390663	MC390663	23.8 mm 15/16"	Audi TT; 00-02, Volkswagen Golf A4 99-01 Con programa de estabilidad electrónica
390676	MC390676	23.8 mm 15/16"	Chevrolet Grand Am 01-05, Malibu LS V6 3.1 Lts. 02-05
390678	MC390678	23.8 mm 15/16"	Ford Focus LX, SE, ZTS, Wagon 00-04, Focus ZX3 00-04, Focus STV 02, con C/ de Tracción
390690	MC390690	25.4 mm 1"	Ford Escape 4X2 01-04
390691	MC390691	25.4 mm 1"	Ford Escape 4X4 01-04
390693	MC390693	25.4 mm 1"	Ford Lincoln Town Car 01-07, Grand Marquis 01-04. Sin Control de Tracc.
390695	MC390695	26.9 mm 1-1/16"	Ford F150 sin control de tracción D/T 00-03
390696	MC390696	26.9 mm 1-1/16"	Ford Ranger 01. Sin Ctrl./ Vel.
390697	MC390697	25.4 mm 1"	Chevrolet Trail Blazer LS, LT, 4X2 02-06. Trail Blazer Ext 4X2. 04-05
390698	MC390698	20.6 mm 13/16"	Mercedes Benz C1500 01-05, C1600 99-05, Mercedes Benz C155 03-06, S430 00-05
390702	MC390702	25.4 mm 1"	Ford Lincoln Town Car 01-07, Grand Marquis 01-04. con C/ de Traccion
390707	MC390707	23.8 mm 15/16"	Chevrolet Tracker 99-04
390708	MC390708	23.8 mm 15/16"	Chrysler Dodge Grand Voyager D/T Sin control de tracc 01-02, Voyager 01-08, Town & Country 01-07 sin C/ de Tracc, Ram-2500 03-08, Ram-2500 Quad Cab 03-08, Ram-2500 ST, Ram-2500 Quad Cab SLT 07-08 Nacional, Chrysler Dodge Caravan 01-07 Gran caravan 01-05 Disco Tambor USA
390709	MC390709	26.9 mm 1-1/16"	Chrysler Town & Country Van 01-02, Voyager; 01-02, Grand Voyager 01-02 Nacional, Chrysler Dodge Caravan 01-02, Gran Caravan 01-02 Disco disco Sin control de taccion USA
390710	MC390710	26.9 mm 1-1/16"	Chrysler Town & Country Con Control de Tracc 01-05, Grand Voyager 01-02 D/D Con control de tracc Nacional, Chrysler Dodge Caravan 01-02, Gran Caravan 01-02 Disco disco Con control de taccion USA

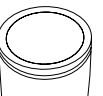



CILINDRO MAESTRO			
No. PARTE LUSAC	No. PARTE RAYBESTOS	DIAMETRO	APLICACIÓN
390712	MC390712	26.9 mm 1-1/16"	Jeep Liberty 02-05 Left Hand Driver
390719	MC390719	23.8 mm 15/16"	Chrysler: 300M 01-04, Concorde 01-02, Intrepid 01
390720	MC390720	25.4 mm 1"	Chrysler Stratus 02-06 4 Pts sedan Disco Disco
390721	MC390721	23.8 mm 15/16"	Honda: CR-V EX, EX-L 02-04 Nacional, Acura RSX 02-06 USA
390722	MC390722	22.2 mm 7/8"	Honda Civic 02-05.
390724	MC390724	22.2 mm 7/8"	Chrysler Dodge Verna 04-06 Sin ABS
390730	MC390730	23.8 mm 15/16"	Honda CR-V LX 02-04
390732	MC390732	33.3 mm 1-5/16"	Chrysler Dodge Ram 2500 y Quad Cab 01-02, Ram 3500 00-02, Ram 4000 02
390734	MC390734	20.6 mm 13/16"	Toyota Corolla 04-08, Matrix 03-08 Estándar Nacional, Chevrolet Vibe 05-08 USA
390735	MC390735	20.6 mm 13/16"	Toyota Corolla 03-08 Transmision Automatica, Matrix 03-08 Nacional, Chevrolet Vibe 05-08 USA
390739	MC390739	25.4 mm 1"	Chevrolet Equinox 05-06, Pontiac Torrent 06-09 Nacional, Saturn Truck:VUE 03-05 USA
390740	MC390740	31.7 mm 1-1/4"	Ford Expedition Sin control de tracción 02
390741	MC390741	28.5 mm 1-1/8"	Ford Econoline E-150 Con Control De Traccion 02-03, Econoline Wagon E-150 8 Pasajeros ConControl De Traccion 02-03
390742	MC390742	33.3 mm 1-5/16"	Chrysler Dodge Ram 1500 02-08, Ram 2500 05-10 Con ABS a las 4 ruedas
390745	MC390745	25.4 mm 1"	Chrysler 300M 02-04, Concorde 02 Nacional, Chrysler Intrepid 02-04 USA
390746	MC390746	13/16"	Honda Civic LX, EX sin ABS 02-06
390747	MC390747	23.8 mm 15/16"	Nissan Sentra 1.8 Lts 01-06, Sentra 2.0 Lts 01, Sentra 2.5 Lts 02-06 y 08, con ABS
390748	MC390748	23.8 mm 15/16"	Nissan: Sentra 2.5 Lts 02-06 Con ABS
390749	MC390749	23.8 mm 15/16"	Nissan: Sentra 2.5 Lts 02-04 Sin ABS
390753	MC390753	22.2 mm 7/8"	Toyota Camry 02-04 Nacional Con Control de estabilidad, Lexus ES300 02-03 USA Con control deEstabilidad
390754	MC390754	22.2 mm 7/8"	Toyota:Camry Sin ABS 02-06, Solara 05-06 Sin control de Estabilidad
390759	MC390759	22.2 mm 7/8"	Mitsubishi Lancer LS, ES 04-06. Automatic Transaxle sin ABS
390760	MC390760	22.2 mm 7/8"	Mitsubishi Lancer LS, Diamond, ES, DS. 04-06
390762	MC390762	28.5 mm 1-1/8"	Ford Expedition 03-06, Lincoln Navigator 03-06 sin control de estabilidad
390764	MC390764	23.8 mm 15/16"	Nissan Infiniti I-35 Sport 02-03.
390765	MC390765	13/16" & 15/16"	Mercedez Benz C240 01-02 4 Ruedas Con ABS
390768	MC390768	7/8" & 1"	BMW X5 02-08
390774	MC390774	25.4 mm 1"	Nissan Pathfinder 02 Nacional, Infiniti QX4 02-03 USA
390778	MC390778	25.4 mm 1"	Audi A4 02-09, Audi A6 02-04 y 07-11, Audi A8 97-01, Audi S6 01-04, Audi RS4 02, VolkswagenPassat 1.8 Lts y 2.8 Lts V6 02-05, Passat W8 03-05
390781	MC390781	25.4 mm 1"	Mitsubishi Outlander 04-10 Con Abs
390782	MC390782	33.3 mm 1-5/16"	Chrysler Ram-1500 02-06, Ram-2500 03-06, Ram-2500 Quad Cab 03-06, Ram 3500 02 5.9 Lts V6Diesel
390783	MC390783	20.6 mm 13/16"	Honda Accord Sedan 03-07 4 Cilindros
390784	MC390784	20.6 mm 13/16"	Honda Accord 03-07 V6 Coupe
390787	MC390787	28.5 mm 1-1/8"	Ford Econoline E-150 Sin Control De Traccion 02-03, Econoline Wagon E-150 8 Pasajeros Sin Control02-03
390788	MC390788	25.4 mm 1"	Chrysler Pacifica 04-06 Sin control de tracción, Town & Country 03-07 Sin ABS
390790	MC390790	26.9 mm 1-1/16"	Ford Explorer Eddie Bauer XLS V-6, XLT V8, Limited 01-05. Explorer Sport 03-05 Trans. ManualNacional, Ford Mercury Mountainer 05.USA Trans. Manual
390802	MC390802	31.7 mm 1-1/4"	Ford Lobo 150 01-02, Lobo 250 01-02 Sin control de cruceo
390804	MC390804	34.0 mm	Chevrolet Avalanche 1500 03, Escalade 04-06, Escalade ESV 04-06, Escalade EXT 04-06 Nacional,Chevrolet Tahoe 03-06, Yukon 04-06, Yukon XL 1500 04-06 USA
390805	MC390805	25.4 mm 1"	Chevrolet Escalade 03, Escalade EXT 03 Nacional, Chevrolet Tahoe 03, Yukon 03,Yukon XL 150003 USA
390806	MC390806	25.4 mm 1"	Chevrolet Avalanche 1500 03-08, Escalade 03-05, Escalade ESV 04-05, Escalade EXT 03-05Nacional, Chevrolet Sierra 1500 03-06, Sierra 1500HD 03, Sierra Classic 1500 07, Silverado 1500 03-06, Silverado 1500HD 03, Silverado Classic 1500 07,Tahoe 03, Yukon 03-06 USA
390807	MC390807	22.2 mm 7/8"	Honda: Civic 02-04
390808	MC390808	22.2 mm 7/8"	Honda Civic 04-05 Sin ABS
390809	MC390809	23.8 mm 15/16"	Ford Focus de tracción dinámica de avance Interactivo 00-03
390810	MC390810	25.4 mm 1"	Ford Windstar 02-03, Freestar 04-05
390811	MC390811	25.4 mm 1-1/8"	Ford F-150 04-10, Lobo 04-10 Mark LT 06-08
390812	MC390812	25.4 mm 1"	Ford Sable 03-05 Nacional, Taurus 03-06 USA
390816	MC390816	23.8 mm 15/16"	Chrysler Dodge Stratus 03-06



CILINDRO MAESTRO			
No. PARTE LUSAC	No. PARTE RAYBESTOS	DIAMETRO	APLICACIÓN
390818	MC390818	37.0 mm	Chevrolet Avalanche 2500 03-06, Express 2500 03-07, Express 2500 EXT 03-07, Express 3500 03-07, Express 3500 EXT 03-07, Silverado 1500 03-07, Silverado 2500 03-07, Silverado 3500 03-07, Suburban 2500 03-06, Sierra 1500 07 Nacional, Savana 2500 03-07, Savana 3500 03-07, Sierra 150003-06, Sierra 2500 03-07, Sierra 3500 03-07, Yukon XL 2500 03-06 USA
390819	MC390819	23.8 mm 15/16"	Ford Focus con ABS 00-08
390820	MC390820	25.4 mm 1"	Ford F-150 03 D/T
390821	MC390821	25.4 mm 1"	Chrysler Dodge Ram 1500 03-05 Con ABS a las ruedas traseras
390824	MC390824	20.6 mm 13/16"	Toyota Tacoma 01-04 USA
390825	MC390825	22.2 mm 7/8"	Toyota Rav4 03-05 Transmision Estadar Sin control de estabilidad
390832	MC390832	22.2 mm 7/8"	Toyota Rav 4 03-05 Transmision Automatica sin control de estabilidad
390833	MC390833	20.6 mm 13/16"	Toyota Rav 4 04-05 Transmision Automatica con control de estabilidad
390835	MC390835	25.4 mm 1"	Nissan Pathfinder Transmision automática 03-04
390838	MC390838	25.4 mm 1"	Nissas Frontier 3.3 Lts 01-02
390843	MC390843	34.0 mm	Chevrolet Avalanche 1500 04-06, Escalade 04-06, Escalade ESV 04-06, Escalade EXT 04-06, Express 1500 03-07, Express 2500 04-06, Express 2500 EXT 04-06, Sierra Classic 1500 07-10, Silverado 1500 02-06 Nacional, Chevrolet Savana 1500 03-07, Savana 2500 03-05, Savana 2500EXT 03-05, Sierra 1500 04-06, USA
390845	MC390845	25.4 mm 1"	Chevrolet Colorado 04-08, GMC Canyon 07-08 Nacional, Kia Sportage 99-02 USA
390847	MC390847	31.7 mm 1-1/4"	Ford Econoline E-150, Econoline Wagon E-150 04 Sin control de cruceo
390848	MC390848	33.3 mm 1-5/16"	Ford Econoline E250 Ext. 06-07, Econoline E350 Super Duty 07, Econoline E350 Super Duty Ext.07, Wagon E350 Super Duty 07 Con Control de Cruceo
390852	MC390852	25.4 mm 1"	Chrysler Dodge Durango 04-06 Sin Control de Tracc
390853	MC390853	31.7 mm 1-1/4"	Chrysler Dodge Durango 04-05 Con control de traccion
390854	MC390854	25.4 mm 1"	Nissan Quest 04-09 Sin control de estanilidad
390855	MC390855	25.4 mm 1"	Nissan Quest 04-09 Con control de estabilidad
390857	MC390857	22.2 mm 7/8"	Toyota Camry 05-06 Nacional, Lexus ES330 04-06 USA Con Control de Estabilidad
390858	MC390858	23.8 mm 15/16"	Nissan Maxima 04-08 Sin control de estabilidad
390859	MC390859	23.8 mm 15/16"	Nissan Maxima 04-08 Con control de estabilidad
390867	MC390867	25.4 mm 1"	Nissan Frontier XE V6 4X4 Transmision manual 03-04, Xterra Sin control de estabilidad 03-04
390868	MC390868	25.4 mm 1"	Nissan Quest 99-02
390870	MC390870	19.0 mm 3/4"	Toyota Sienna 04-10 Con control de tracción
390874	MC390874	25.4 mm 1"	Mitsubishi Lancer LS 04-05, Mitsubishi Raliant 05 4 Ruedas con ABS
390881	MC390881	22.2 mm 7/8"	Chevrolet Aveo 08 Transmision Manual con ABS
390885	MC390885	23.8 mm 15/16"	Chevrolet Malibu 05-10, Malibu Classic 08, Pontiac G6 05-07
390886	MC390886	25.4 mm 1"	Mitsubishi Endeavor 04-11 Tracción en todas las ruedas y sin control de Estabilidad del Vehículo
390888	MC390888	22.2 mm 7/8"	Chevrolet Aveo 08. Pontiac G3 06-08 Transmision automatica con ABS
390897	MC390897	25.4 mm 1"	Mitsubishi Galant ES 2.4 04-05 Sin ABS
390898	MC390898	22.2 mm 7/8"	Toyota Camry V6 02-06, Solara 05-06 Nacional, Lexus ES300 02-03, ES330 04-06 USA
390899	MC390899	23.8 mm 15/16"	Toyota: Camry XLE 05-06, Solara 05-06 Con Control de estabilidad
390909	MC390909	26.9 mm 1-1/16"	Ford Escape Sport, Limited, XLT 4X4 05-07, Mercury Mariner 05-07 disco disco Nacional, Mazda Tribute 05-06 Transmision Manual USA
390910	MC390910	25.4 mm 1"	Ford Escape Limited, XLS, XLT, Sport Automatica 05-07, Mercury Mariner Trac delantera 05-07 Nacional, Mazda Tribute 05-06 USA
390919	MC390919	25.4 mm 1"	Ford Five Hundred 05-07, Freestar 06-07, Mercury Montego 05-07 Nacional, Freestyle 05-07, Monterey 06-07 USA Con control de traccion
390923	MC390923	13/16" & 7/8"	BMW 323i 98-01, 323 Ti 99-01
390925	MC390925	23.8 mm 15/16"	Volkswagen Beetle; 02-10, Golf; 02-05, Jetta A4 03-09, Jetta Clasico 10-13, Jetta cuty 06-09 FTE Conprograma de estabilidad electronica (ESP) sustituye al 390955
390926	MC390926	25.4 mm 1"	Chrysler Dodge Dakota 05-10 Con ABS a las ruedas traseras
390927	MC390927	28.5 mm 1-1/8"	Chrysler Dodge Dakota 05-11 Con ABS
390930	MC390930	25.4 mm 1"	Chevrolet Silverado 1500 02-07, Sierra 1500 07
390931	MC39877	22.2 mm 7/8"	Volkswagen Derby 95-02, Golf A3 CL, GL.1.8 Lts 93-94 y 97-99, Golf A3 GLS 93 y 97-99, Golf Cabrio A3 97-99, Golf Cabrio A4 00-02, Golf GTI A3 93-94 y 97-99, Jetta GLS, Europa A3 93 y 97-99, Passat 91-93 y 96-97
390933	MC390933	23.8 mm 15/16"	Chevrolet Malibu 08, Pontiac G6 GT 05-07 Nacional, Saturn Aura 07-08 USA
390947	MC390947	25.4 mm 1"	Nissan Xterra 00-02
390957	MC390957	33.3 mm 1-5/16"	Ford F-250 05-07, F-350 05-07, F-450 05-07, F-550 05-07 Sin control de freno integral

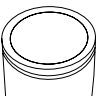



CILINDRO MAESTRO			
No. PARTE LUSAC	No. PARTE RAYBESTOS	DIAMETRO	APLICACIÓN
390960	MC390960	25.4 mm 1"	Ford Five Hundred 05-07, Freestar 06-07, Mercury Montego 05-07 Nacional, Freestyle 05-07, Monterey 06-07 USA Sin control de traccion
390961	MC390961	31.7 mm 1-1/4"	Ford F250 96-97, F350 96-97 4x2 Sin control de crusero
390964	MC390964	20.6 mm 13/16"	Toyota Tacoma 06-08 Transmisión Automatica
390965	MC390965	20.6 mm 13/16"	Toyota Tacoma 06-08 Transición Manual
390966	MC390966	22.2 mm 7/8"	Toyota Camry 05-06
390970	MC390970	22.2 mm 7/8"	Toyota Camry LE, XLE 07-11
390971	MC390971	22.2 mm 7/8"	Toyota Camry LE, XLE 07-11 (Fabricado en Japón)
390975	MC390975	23.8 mm 15/16"	Dodge Town & Country 06-07 D/T con ABS Nacional, Caravan 03-07, Grand Caravan 03-07 USA
390976	MC390976	31.7 mm 1-1/4"	Chrysler Dodge Ram 1500 SLT 06
390977	MC390977	25.4 mm 1"	Chrysler 300C 05-07, Charger 06-07 Nacional, 300 05-07, Magnum 05-07 USA
390978	MC390978	25.4 mm 1"	Chrysler Dodge Charger 06-07 Sin Control de Tracc
390979	MC390979	23.8 mm 15/16"	Mercedes Benz Sprinter 315 07-11, Sprinter 316 04-06, Sprinter 415 07-11, Sprinter 515 07-09, Sprinter 2500 03-07, Sprinter 3500 03-07
390980	MC390980	25.4 mm 1"	Mercedes Benz Sprinter 316 04-06, Sprinter 416 04-06 Nacional, Sprinter 2500 03-06, Sprinter 350003-06 USA
390985	MC390985	22.2 mm 7/8"	Chevrolet Pontiac G4 05-06, G5 07-09 Disco tambor
390986	MC390986	31.7 mm 1-1/4"	Chevrolet Avalanche 07-08, Silverado 1500 07-08, Tahoe 07-08, Cadillac Escalade 07-08, EscaladeESV 07-08, Escalade EXT 07-08, GMC Sierra 1500 07-08, Yukon 07-08, Yukon XL 1500 07-08 con control de activación de freno
390988	MC390988	26.9 mm 1-1/16"	Mercedes Mercedes Benz Sprinter 415 07-11, Sprinter 416 04-11, Sprinter 515 07-11, Benz 2500 07-11, Mercedes Benz 3500 07-11
390991	MC390991	25.4 mm 1"	Chrysler 300C 06-07, Charger 06-07
390996	MC390996	25.4 mm 1"	Nissan Frontier SE, LE, XE 4X2 Transmisión Automatica 06-11, Xterra 4X2 Transmisión Automatica 05
390997	MC390997	22.2 mm 7/8"	Honda CR-V 07-11
390998	MC390998	25.4 mm 1"	Honda CR-V 05-06
391000	MC391000	22.2 mm 7/8"	Honda Fit 07-08
391001	MC391001	1 1/16"	Chrysler Grand Cherokee 06-10, Jeep Commander 06-10
391002	MC391002	19.0 mm 3/4"	Honda Civic EX, LX 06-11
391004	MC391004	22.2 mm 7/8"	Acura MDX 07-13, Acura ZDX 10, Honda Odyssey 05-10
391005	MC391005	20.6 mm 13/16"	Toyota Yaris 07-11 Con Transmisión Manual
391006	MC391006	20.6 mm 13/16"	Toyota Yaris 07-11 Trans Automatica
391007	MC391007	26.9 mm 1-1/16"	Acura MDX 05-06, Honda Pilot 03-08, Ridgeline 07-08
391008	MC391008	25.4 mm 1"	Nissan Frontier SE, LE, XE Transmisión Manual 06-09 y 11, Xterra 4X2 Transmisión Manual sin control de estabilidad 05
391010	MC391010	25.4 mm 1"	Chevrolet Uplander 05-09, Pontiac Montana SV6 05-09 Nacional, Terraza 05-07, Saturn Truck:Relay05-07 USA
391013	MC391013	22.2 mm 7/8"	Mitsubishi Lancer ES 04-07
391014	MC391014	25.4 mm 1"	Mitsubishi Galant ES 2.4 04-09 Con ABS
391020	MC391020	26.9 mm 1-1/16"	Jeep:Grand Cherokee Con control de programa electronico 05
391022	MC391022	22.2 mm 7/8"	Chrysler Dodge Attitude 06-11 sin ABS
391022	MC391022	22.2 mm 7/8"	Chrysler Dodge Attitude 06-11 sin ABS
391024	MC391024	22.2 mm 7/8"	Chrysler Dodge Attitude 06-11 con ABS
391026	MC391026	37.0 mm	Chevrolet Express 3500 04-08, Express 3500 EXT 04-08, G-30 Express cargo van 3500 03 Nacional, Chevrolet Savana 3500 04-07, Savana 3500 EXT 04-07 USA
391030	MC391030	23.8 mm 15/16"	Chrysler PT Cruiser 04 Tambor de 9" sin ABS
391031	MC391031	22.2 mm 7/8"	Chrysler PT Cruiser 05-10 Disco disco con ABS
391032	MC391032	22.2 mm 7/8"	Chrysler PT Cruiser 05-09 Disco Tambor sin ABS
391037	MC391037	25.4 mm 1"	Audi A4 1.8L L4 Turbocharged Cilindro tipo ATE 03-08, Audi A6 02-04, Volkswagen Passat 03-05
391041	MC391041	26.9 mm 1-1/16"	Ford F-150 00-01
391043	MC391043	33.3 mm 1-5/16"	Ford F-250 05-07, F-350 05-07, F-450 05-07, F-550 05-07 Con control de freno integral
391045	MC391045	26.9 mm 1-1/16"	Ford Explorer 02-05, Lincoln Aviator 03-05 Nacional, Mercury Mountaineer 03-05 USA
391049	MC391049	25.4 mm 1"	Mazda3 06-13, Mazda3 Sport 10-13 Con ABS
391066	MC391066	20.6 mm 13/16"	Chrysler Dodge Caliber Con ABS 07-12, Jeep Compass 07-14, Jeep Patriot 07-14
391068	MC391068	25.4 mm 1"	Jeep Wrangler 07-14 para disco delantero con diametro de 11.89"



CILINDRO MAESTRO			
No. PARTE LUSAC	No. PARTE RAYBESTOS	DIAMETRO	APLICACIÓN
391069	MC391069	20.6 mm 13/16"	Ford Fusion 06-09, Lincoln MKZ 07-08, Lincoln Zephyr 06, Mercury Milan 07-08, Mazda 6 06-08 ConABS
391071	MC391071	20.6 mm 13/16"	Chrysler Dodge Caliber 07-11 Sin ABS
391072	MC391072	30.1 mm 1-3/16"	Nissan Armada 04-13, Titan Con Control de estabilidad y control dinamico 04-13 Nacional, InfinitiQX56 04-10 USA
391080	MC391080	28.5 mm 1-1/8"	Chevrolet Sierra 1500 07, Silverado 1500 07 sin control de activación de frenos
391081	MC391081	37.0 mm	Chevrolet C-3500 07-08, Express 2500 08, Express 2500 EXT 08, Express 3500 08, Express 3500EXT 08, Sierra 2500HD 07-08, Sierra 3500HD 07-08, Silverado 2500HD 07-08 Nacional, Savana 250008, Savana 3500 08 USA
391081	MC391081	37.0 mm	Chevrolet C-3500 07-08, Express 2500 08, Express 2500 EXT 08, Express 3500 08, Express 3500EXT 08, Sierra 2500HD 07-08, Sierra 3500HD 07-08, Silverado 2500HD 07-08 Nacional, Savana 250008, Savana 3500 08 USA
391082	MC391082	37.0 mm	Chevrolet C-3500 07-08, Express 2500 08, Express 2500 EXT 08, Express 3500 08, Express 3500EXT 08, Sierra 2500HD 07-08, Sierra 3500HD 07-08, Silverado 2500HD 07-08 Yukon 1500 XL 07-08, Nacional, Savana 2500 08, Savana 3500 08 USA
391085	MC391085	23.8 mm 15/16"	Toyota Tundra 07-13, Sequoia 08-13
391092	MC391092	23.8 mm 15/16"	Volkswagen New Beetle con control de estabilidad 02-10, Jetta A4 03-09, Jetta Clasico 10-13, Jettacuty 06-09 FTE
391096	MC391096	25.4 mm 1"	Nissa Frontier SE 4X2 07-11, Pathfinder 05-09, Xterra 4X4 Transmision Automatica 05-07
391097	MC391097	25.4 mm 1"	Nissan Frontier SE 4X2 07-10, Xterra 05-07 Transmision Automatica Con control de estabilidad ycontrol dinamico
391098	MC391098	25.4 mm 1"	Nissan Frontier SE 4X4 Transmision Automatica 07, Pathfinder SE todo terreno 05-09, Xterra 4X4 05-07
391100	MC391100	22.2 mm 7/8"	Honda Pilot 09-14
391101	MC391101	20.6 mm 13/16"	Acura TSX 10-11, Honda Accord 08-11
391110	MC391110	30.1 mm 1-3/16"	Chrysler Dodge Durango 06
391121	MC391121	31.7 mm 1-1/4"	Chrysler Dodge Ram 1500 07-14, Ram 2500 11, Ram 4000 11
391122	MC391122	31.7 mm 1-1/4"	Chrysler Aspen 07-09, Dodge Durango 06-09
391123	MC391123	25.4 mm 1"	Chrysler Dodge Nitro 07-11, Jeep Liberty 08-11, Jeep Wrangler 09-12
391126	MC391126	26.9 mm 1-1/16"	Chrysler 300C SRT8 6.1 Lts 08, Charger 5.7 Lts 08
391130	MC391130	25.4 mm 1"	Volkswagen Eurovan 00-03 con ABS
391133	MC391133	26.9 mm 1-1/16"	Ford Explorer 09-10, Explorer Sport Trac 07-10 Nacional, Mercury Mountaineer 09-10 USA
391134	MC391134	20.6 mm 13/16"	Ford Fusion 09, Lincoln MKZ 09, Mercury Milan 09
391137	MC391137	23.8 mm 15/16"	Ford Focus 09-11 con control de estabilidad
391138	MC391138	22.2 mm 7/8"	Toyota Hiighlander 08-11, Toyora Sienna 11
391139	MC391139	27.0 mm	Ford Ranger 07-09
391142	MC391142	22.2 mm 7/8"	Chrysler Dodge Avenger Disco tambor 08-10 Nacional, Dodge Sebring 09 USA
391143	MC391143	23.8 mm 15/16"	Dodge Caliber SRT-4 08-09
391144	MC391144	22.2 mm 7/8"	Chrysler Dodge Avenger R/T Disco disco 08-13 Nacional, Dodge Sebring 07-10 USA
391145	MC391145	25.4 mm 1"	Chevrolet Captiva Sport 08-13, Equinox 07-08, Pontiac Torrent 07-09
391146	MC391146	22.2 mm 7/8"	Chevrolet Aveo 08 Transmison manual sin ABS con valvulas de 16mm
391150	MC391150	28.5 mm 1-1/8"	Ford F-150 09
391154	MC391154	25.4 mm 1"	Chevrolet Cruze 10-12, Malibu 13, Verano 13, Buick LaCrosse 10-11,
391156	MC391156	23.8 mm 15/16"	Nissan Tiida Sedan Custom 10-12, Tiida Emotion 10-11, Tiida Comfort 10-12, Tiida HB Emotion 10-12Tiida HB Premium 10-11, Todos Transmision Standar Nacional Versa 07-11 USA
391157	MC391157	23.8 mm 15/16"	Ford Focus 09-11 sin control de estabilidad
391161	MC391161	1 5/16"	Ford F-250 Super Duty 11, F-350 Super Duty 11, F-450 Super Duty 11, F-550 Super Duty 11 Conbooster de vacio
391165	MC391165	23.8 mm 15/16"	Chevrolet HHR 08-09 Transmision automotica
391168	MC391168	38.1 mm 1-1/2"	Chevoelt C-3500 09-13, Express 2500 09-14, Express 3500 09-14, Silverado 2500 HD 09-13,Suburban 2500 09-10 Sin control de freno activo
391169	MC391169	28.5 mm 1-1/8"	Chevrolet Cheyenne 07-13, Silverado 1500 07-14, Gmc Sierra SLE 07-14
391170	MC391170	22.2 mm 7/8"	Chevrolet Aveo 08-11, Pontiac G3 09-10 Transmision Automatica sin ABS
391171	MC391171	25.4 mm 1"	Chevrolet Astra 08-09
391172	MC391172	31.7 mm 1-1/4"	Chevrolet Avalanche 09-13, Cheyenne 09-13, Sierra SLT 1500 09-14, Silverado 1500 10-14,Suburban 1500 10-13, Yukon 09-14, Yukon XL 1500 09-14, Tahoe 09-13, Cadillac Escalade 09-14, Cadillac Escalade ESV y EXT 09-14
391173	MC391173	22.2 mm 7/8"	Toyota Corolla 09, Matrix 09-11
391175	MC391175	22.2 mm 7/8"	Chevrolet Pontiac G5 09 Nacional, Chevrolet Cobalt 09-10 USA Transmison automatica con programade control de estabilidad

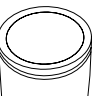



CILINDRO MAESTRO			
No. PARTE LUSAC	No. PARTE RAYBESTOS	DIAMETRO	APLICACIÓN
391176	MC391176	22.2 mm 7/8"	Chevrolet Pontiac G5 09 Nacional, Chevrolet Cobalt 09-10 USA Transmision automatica sin programade control de estabilidad
391177	MC391177	22.2 mm 7/8"	Chevrolet Pontiac G5 09 Nacional, Chevrolet Cobalt 09-10 USA Transmision manual con programa decontrol de estabilidad
391178	MC391178	22.2 mm 7/8"	Chevrolet Pontiac G5 09 Nacional, Chevrolet Cobalt 09-10 USA Transmision manual sin programa decontrol de estabilidad
391183	MC391183	38.1 mm 1-1/2"	Chevoelrt C-3500 09-13, Silverado 2500 HD 09-10, Silverado 3500HD 09-13, Suburban 2500 09,GMC Sierra 2500HD 09-10, Sierra 3500HD 09-11
391184	MC391184	38.1 mm 1-1/2"	Chevoelrt C-3500 10-13, Express 2500 09-14, Express 2500 EXT 09-14, Express 3500 09-11, Express3500 EXT 09-13, Silverado 2500 HD 09-11, Silverado 3500HD 10-13, Suburban 2500 10-11 Con control de freno activo
391185	MC391185	23.8 mm 15/16"	Chevrolet Malibu 03-08, Pontiac G6 08
391186	MC391186	23.8 mm 15/16"	Chevrolet Malibu 08-12, Pontiac G6 09
391187	MC391187	23.8 mm 15/16"	Pontiac G5 09 Nacional, Chevrolet Cobalt 09-10 manual trans, w/ ss model USA
391191	MC391191	33.3 mm 1-5/16"	Ford Econoline E-150 09-12, Econoline E-350 6.8 Lts 09-14 Con control para activación de freno y/oControl de estabilidad
391195	MC391195	33.3 mm 1-5/16"	Ford Econoline E-15 08, Econoline E-15 Club Wagon 08, F-250 08-10, Ford F-350 Super Duty 05-11,F-350 Super Duty King Ranch 05-11, F-350 Super Duty Lariat 05-11, F-350 Super Duty XL 05-11, F- 350 Super Duty XLT 05-11, F-350 Super Duty FX4 08-09, F-450 Super Duty 10-11, F-550 Super Duty 08-10 Con control de freno integral
391197	MC391197	38.1 mm 1-1/2"	Ford F-250 08-10, Ford F-350 Super Duty 09-11, F-350 Super Duty King Ranch 10-11, F-350 SuperDuty Lariat 10-11, F-350 Super Duty XL 10-11, F-350 Super Duty XLT 10-11, F-450 Super Duty 10- 11, F-550 08-10 sin control de freno integral
391198	MC391198	34.9 mm 1-3/8"	Ford E-350 Super Duty 09, F-450 09-12, F-550 09-12 Dole Rodada Sin control de estabilidad
391200	MC391200	38.1 mm 1-1/2"	Ford F-250 08-10, F-350 08-10, F-450 08-10, F-550 08-10 Sin control de freno integral
391202	MC391202	26.9 mm 1-1/16"	Ford Escape Sport, XLS, 07-08, Mariner 07-08 Nacional Mazda Tribute 08 transmisión automáticaUSA
391203	MC391203	26.9 mm 1-1/16"	Ford Escape Sport, XLS, 09-11, Mariner 09-11 Nacional Mazda Tribute 09-11 TransmisionAutomatica USA
391204	MC391204	26.9 mm 1-1/16"	Mercury Mariner 08 Nacional, Ford Escape Sport, XLS, 09-11 transmisión manual USA
391205	MC391205	4/8"	Lincoln MKS 09-12 Nacional, Ford Flex 09-11 USA
391218	MC391218	26.9 mm 1-1/16"	Nissan 350Z 03-09
391219	MC391219	20.6 mm 13/16"	Toyota Corolla 09-11, Matrix 09
391222	MC391222	25.4 mm 1"	Mitsubishi Endeavor 04-08 Sin control de tracción
391225	MC391225	25.4 mm 1"	Honda Ridgeline 09-14
391227	MC391227	19.0 mm 3/4"	Honda Civic EXL 08-11
391228	MC391228	19.0 mm 3/4"	Honda Fit 09-10, w/o traction control
391231	MC391231	22.2 mm 7/8"	Audi A3 06-12, Volkswagen Eos 10, Golf A5 10, Golf GTI 07-11 Cil ATE
391232	MC391232	22.2 mm 7/8"	Volkswagen Bora 06-10 FTE, Golf A5 07-11, Jetta A5 09-11, Jetta A6 11-12
391233	MC391233	22.2 mm 7/8"	Volkswagen CC 09-12, Passat 06-11, Passat CC 09-11
391236	MC391236	33.3 mm 1-5/16"	Ford Econoline E-350 08 Rodada sencilla sin control de estabilidad
391254	MC391254	23.8 mm 15/16"	Ford Transit Connect 09-10
391267	MC391267	23.8 mm 15/16"	Nissan Rogue 08-12
391271	MC391271	23.8 mm 15/16"	Chrysler Dodge Journey 09-14
391274	MC391274	22.2 mm 7/8"	Toyota Corolla 09-13,Matrix 10-13
391299	MC391299	20.6 mm 13/16"	Toyota Rav 4 06-11
391304	MC391304	22.2 mm 7/8"	Nissan Tiida Sedan Custom 07-12, Tiida Emotion 07-11, Tiida Premium 07-09, Tiida Comfort 10-12,Tiida HB Emotion 07-12 Tiida HB Premium 07-11, Todos Estándar y Automatico Nacional Versa 09-11 USA
391306	MC391306	23.8 mm 15/16"	Nissan Sentra 07-10 transmisión automática
391307	MC391307	23.8 mm 15/16"	Nissan Sentra 07-10 transmisión estándar
391309	MC391309	23.8 mm 15/16"	Nissan Altima 2.5 Lts 08-10
391310	MC391310	23.8 mm 15/16"	Nissan Altima 3.5Lts 08-14, Maxima 09-14
391311	MC391311	23.8 mm 15/16"	Nissan Altima 07-14
391321	MC391321	22.2 mm 7/8"	Mini Cooper 02-08, Cooper S 02-08
391323	MC391323	23.8 mm 15/16"	Subaru Legacy 06-08, Outback 06-08
391324	MC391324	23.8 mm 15/16"	Subaru Impreza 08-11, Legacy 07-09, Outback 06-09, Forester 09-12
391328	MC391328	23.8 mm 15/16"	Chevrolet HHR Transmision standar 06-08
391329	MC391329	23.8 mm 15/16"	Chevrolet HHR 06-08 Transmision Automatica



CILINDRO MAESTRO			
No. PARTE LUSAC	No. PARTE RAYBESTOS	DIAMETRO	APLICACIÓN
391330	MC391330	19.0 mm 3/4"	Nissan Altima 07-11
391331	MC391331	22.2 mm 7/8"	Chevrolet Aveo 09-11, Aveo 5 09-11, con ABS transmisión Automática Pontiac G3 09-10
391332	MC391332	22.2 mm 7/8"	Chevrolet Aveo 09-11, Aveo 5 09-11, con ABS transmisión estándar Pontiac G3 09-10
391333	MC391333	22.2 mm 7/8"	Chevrolet Aveo 09-11, Aveo 5 09-11, Sin ABS Transmison Standar Pontiac G3 09-10
391337	MC391337	3/4"	Toyota Camry 07-11 Nacional, Highlander 06-07 USA
391358	MC391358	23.8 mm 15/16"	Chevrolet HHR 08-09
391379	MC391379	23.8 mm 15/16"	Ford Focus 09-10 sin ABS
391385	MC391385	26.9 mm 1-1/16"	Jeep Liberty 12-13, Jeep Wrangler 09-13 Para disco delantero con diametro de 13.07"
391390	MC391390	23.8 mm 15/16"	Audi A3 08-13, S3 12, Volkswagen Bora 06-10, Golf 07-13, Golf GTI 06-13, Eos 10, Passat 12-13 CilTeves
475431	MC390660	26.9 mm 1-1/16"	Chrysler Dodge Stratus 98-02 con ABS, Mitsubishi Eclipse con ABS 03-05. Galant con ABS 03Nacional, Chrysler Dodge Stratus Coupe con ABS 01-02. USA,
475973		26.9 mm 1-1/16"	Chrysler Dodge Stratus 98-02 sin ABS y sin control de traccion 01-02, Mitsubishi Eclipse sin ABS y control traction 00-05 Nacional, Chrysler Sebring Coupe, Dodge Stratus Coupe sin ABS y sin control de traccion 01-02. USA,
3495064		22.2 mm 7/8"	Chevrolet Corsa 02-05, Corsa Sedan 03-05 (Fabricado en Europa).
4721565	MC390710	26.9 mm 1-1/16"	Chrysler Town & Country Con Control de Tracc 01-02, Grand Voyager D/D Con control de tracc 01-02Nacional, Chrysler Dodge Caravan, Grand Caravan D/D Con control de Trac, 01-02 Plymouth Voyager USA
5011256	MC390426	31.7 mm 1-1/4"	Chrysler Dodge Pick-up R 1500 00-01 USA
5011260	MC390511	25.4 mm 1"	Jeep Grand Cherokee 99-04
5015160	MC390577	23.8 mm 15/16"	Chrysler PT Cruiser con freno de disco a las 4 ruedas y con ABS 00-05 , Dodge Neon con freno dedisco a las 4 ruedas y con ABS 00-02
5017973		23.8 mm 15/16"	Chrysler PT Cruiser sin ABS 01-05, Neon con freno de disco a las 4 ruedas y sin ABS 02
05019401		25.4 mm 1"	Chrysler Stratus 02-04
05069615		20.6 mm 13/16"	Chrysler Atos 01-04 2 SALIDAS
5080888	MC390742	33.3 mm 1-5/16"	Chrysler Ram 1500 02, Ram 2500 05-10
5083353		20.6 mm 13/16"	Chrysler Atos 4 SALIDAS 02-10
9193225		23.8 mm 15/16"	Chevrolet Astra 1.8 Lts. 00-03, Astra 2.2 Lts. 01-03, Astra Vagoneta 01-03, Zafira 04-06 Sin ABS
18009372	MC39570	24.0mm/31.7mm	Chevrolet S & T15 Jimmy 82-90, S & T15 Sonoma 82-90 USA
18026274	MC390427	25.4 mm 1"	Chevrolet Blazer (S/T 2WD & 4WD) 98-99 Nacional, Chevrolet Pickup (S/T 2WD & 4WD) 98-00USA, Oldsmobile Bravada 98-99 USA
18029970	MC390278	40.0 mm	Chevrolet C-30, C-35, C-3500 92-00, C-3500 HD 96-00
18060790	MC390542	37.0 mm	Chevrolet Avalanche 2500 02, Escalade 02, Escalade EXT 02, Silverado 1500 4X2 y 4X4 4 Ptas.heavy duty 00-01 y 03-06
39009900		25.4 mm 1"	Hyundai H-100 03-06
39009901		22.2 mm 7/8"	Hyundai VERNA 04-06
39009902		20.6 mm 13/16"	Chevrolet C2 04-12, Chevy C2 Sedan 04-12, Chevy Pick Up 99-03
39009903		23.8 mm 15/16"	Chevrolet Astra 1.8 Lts. 00-03 y 07-08, Astra 2.0 Lts. 04-06, Astra 2.2 Lts. 01-03, Astra Vagoneta 01-03, Astra Turbo 07-08
39009904		23.8 mm 15/16"	Ford Fiesta 1.4 Lts 98-09, Fiesta Ikon 99-09, Courier Pick Up 01-09 para autos que lleven la balata7259- D649
39009906		23.8 mm 15/16"	Ford Fiesta 1.6 Lts 03-10, Eco Sport 04-10, Fiesta Firts Brasileño 03-10
39009907		22.2 mm 7/8"	Chevrolet Corsa 06-08, Tornado 04-08 (Fabricado en Brasil).
39009908		25.4 mm 1"	Nissan Urvan C/ABS 02-11
39009909		20.6 mm 13/16"	Toyota Hiace 06-13
39009910		25.4 mm 1"	Nissan Urvan S/ABS 00-11
39009911		20.6 mm 13/16"	Volkswagen Gol 1.6 Lts 09-13, Saveiro 10-13 sin ABS
39009912		19.0 mm 3/4"	Volkswagen CrossFox 11-14, Gol Sport 1.6 Lts 09-11, Gol Tredline 1.6 Lts 09-10, Gol Confordline 1.6Lts 09-10, Lupo 08-09, Saveiro 10-13 con ABS
39009913		23.8 mm 15/16"	Nissan NP300 2.4 Lts 09-12 Gasolina, NP300 2.5 Lts 09-12 Diesel
39009914		20.6 mm 13/16"	Chevrolet Matiz 06-09
39009915		25.4 mm 1"	Nissan X-Trail 2.0i 16V T30 LHD con ABS y Transmison Automatica 02-07
39009916		34.9 mm 1-3/8"	Isuzu Elf 200 09-11, Elf 300 09-11
93172089		25.4 mm 1"	Chevrolet Opel Vectra 03-08, Saab 9-3 06-09
93305031		23.8 mm 15/16"	Chevrolet Meriva 04-06, Tornado 04-07
106437-A	MC36352	31.7 mm 1-1/4"	Ford F-200, F-250 68-71 USA

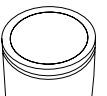



CILINDRO MAESTRO			
No. PARTE LUSAC	No. PARTE RAYBESTOS	DIAMETRO	APLICACIÓN
390700RL		20.6 mm 13/16"	Peugeot 206 XR 01-07, Disco Tambor 4 Cil. 1.4L, Peugeot 206 XT 03-05 Disco Tambor 4 Cil. 1.6L
390801RL		20.6 mm 13/16"	Chevrolet Chevy Joy, Swing 94-03, Chevy Monza 97-03, Chevy Pop 96-03, Chevy Vagoneta 00-03, Chevy Pick Up 99
390901RL		20.6 mm 13/16"	Volkswagen Pointer 1.8 Lts 98-02 Pointer City 00-02 Pointer Vagoneta 99-02
390911RL		20.6 mm 13/16"	Seat Ibiza 01-08, Toledo 1.8 Lts. 01-03, Toledo Sport Turbo 01-05, Volkswagen Golf A2 CL, GL 87-92, Golf GTI A3 89-90, Jetta A2 87-93, 97-98
390921RL		22.2 mm 7/8"	Seat Cordoba 01-09, León 01-07, Volkswagen Golf, Jetta A2 88-93, Passat Importado 1.8/2.0 88-93
390951RL		20.6 mm 13/16"	Volkswagen Combi Panel 73-88
4601000Q		20.6 mm 13/16"	Nissan Aprio 08-10, Platina 02-08, Renault Clio 02-08, Clio Expression 04-08, Clio Energy 07
460107B7	MC390441	25.4 mm 1"	Nissan Frontier 4L 01-02, Frontier V6 01-02
460108B6	MC390466	25.4 mm 1"	Nissan Frontier 98-99 USA
46010A05	MC39555	19.0mm/23.8mm	Nissan Hikari 88-92, Samurai 83-84, Tsuru I 84-87, Tsuru II 88-92, (Cilindro Tokico)
46010F40		23.8 mm 15/16"	Nissan Estaquitas Pick up 87-94, Pick up D-21 92-08, Pick up Doble Cabina 91-03, Pick up corto 90-00, Pick up King Cab 95-00, Pick up Largo 97-03, Pick up 250 94-96, Estaquitas Pick up 95-02 Nabco
46010J01	MC39228	22.2 mm 7/8"	Nissan Pick-up Doble 620 77, 720 81-88 USA
46010W87	MC39150	22.2 mm 7/8"	Nissan Datsun 79-84
98896-A	MC39712	28.5 mm 1-1/8"	Chrysler D-350, Microbus 81-93
F7RZ2140	MC390463	25.4 mm 1"	Ford Contour 96-00
IJ1614019	MC390500	23.8 mm 15/16"	Audi A3 02-03, Audi TT 00-02, Volkswagen Beetle 2.0 lts 98-05, Beetle Turbo 1.8 lts 00-05, Beetle Cabriolet Turbo 1.8 lts 03-05, Golf GTI A4 2.0 lts S/ABS 00-05, Golf A4 2.0 lts S/ABS 00-06, Jeta 2.0 lts A4 00-08
MC390073		23.8 mm 15/16"	Chevrolet Corvette 92-94
MC390163		23.8 mm 15/16"	Audi Cabriolet 97-98
MC390167		23.8 mm 15/16"	Volkswagen 95, Golf 93-95, Jetta 93-95, Passat 95
MC390306		25.4 mm 1"	Ford Lincoln Continental 97
MC390439		23.8 mm 15/16"	Audi A4 97-01. Porche 911 Carrera 01-06, Volkswagen Passat 99
MC390446		25.4 mm 1"	Ford Lincoln Continental 98-99
MC390468		25.4 mm 1"	Subaru Forester 07-08
MC390472		1"	Chevrolet Corvette 97-04
MC390546		23.8 mm 15/16"	Chevrolet Tracker 99-04 Sin ABS
MC390551		26.9 mm 1-1/16"	Honda Odyssey 00-04 Nacional, Acura MDX 01-02 USA
MC390592		34.0 mm	Cadillac DeVille 00-05
MC390621		1 1/16"	Mercedes Benz S420 95-96, S500 95-96, S600 95-96
MC390657		26.9 mm 1-1/16"	Chrysler Stratus 02-05 2 Pts Coupe Con control de Tracc
MC390666		22.2 mm 7/8"	Toyota MR2 Spyder 05
MC390707		23.8 mm 15/16"	CHEVROLET TRACKER 99-04
MC390713		25.4 mm 1"	Saab 9-5 Sedan 01-02, 9-5 Wagon 01-02
MC390714		25.4 mm 1"	Pontiac Aztek 01-05
MC390758		25.4 mm 1"	Cadillac CTS 03-04, Cadillac SRX 04
MC390763		28.5 mm 1-1/8"	Ford Expedition Con control de estabilidad 02-06, Lincoln Navigator 02-06
MC390774		25.4 mm 1"	Nissan Pathfinder 02 Nacional, Infiniti QX4 02-03 USA
MC390784		20.6 mm 13/16"	Honda Accord 03-07 V6 Coupe
MC390822		20.6 mm 13/16"	Toyota Sienna 03 USA
MC390823		25.4 mm 1"	Chrysler Dodge Pacifica 05-06, Town & Country 03-07 Nacional, Caravan 03-07, Grand Caravan 03-07 USA
MC390839		25.4 mm 1"	Nissan Frontier XE V6 4X4 Transmision Automatica 03-04, Xterra 4X4 con control de estabilidad 03-04
MC390855		25.4 mm 1"	Nissan Quest 04-09 Con control de estanilidad
MC390860		20.6 mm 13/16"	Toyota Rav 4 04-05 Transmision Estadar con control de estabilidad
MC390863		7/8"	Chevrolet Aveo 04-05, Pontiac Wave 05
MC390869		7/8"	Chevrolet Aveo 04-05, Pontiac Wave 05, Suzuki Swift+ 04-06
MC390873		25.4 mm 1"	Mitsubishi Lancer LS 04-05, Mitsubishi Raliant 05 Sin ABS
MC390879		28.5 mm 1-1/8"	Nissan Titan 4X2 Sin control Dinamico y sin Diferencial de Deslizamiento Limitado 04-07
MC390885		23.8 mm 15/16"	Chevrolet Malibu 05-10, Malibu Classic 08, Pontiac G6 05-07
MC390896		26.9 mm 1-1/16"	Mitsubishi Lancer Evolution 06



CILINDRO MAESTRO			
No. PARTE LUSAC	No. PARTE RAYBESTOS	DIAMETRO	APLICACIÓN
MC390908		25.4 mm 1"	Cadillac:CTS 05-07, STS 05-07, STS-V 06-07, Cadillac SRX 05-06
MC390915		20.6 mm 13/16"	Acura 3.2TL 06, TL 07-08, Honda Accord 05-07
MC390918		26.9 mm 1-1/16"	Ford Escape Sport, Limited, XLT 4X4 Transmision Manual 05-07 Disco Nacional, Mariner 05-07 USA
MC390922		25.4 mm 1"	Ford Escape Sport, XLS, XLT, Limited 4X4 05-07, Mariner 05-07 disco Tambor Nacional, Mazda Tribute 05-06 Transmision Manual USA
MC390956		38.1 mm 1-1/2"	Ford F-550 Super Duty 05-07 Con control de freno activo
MC390958		26.9 mm 1-1/16"	Ford Mustang 05-08
MC390967		22.2 mm 7/8"	Toyota Camry LE 07-09 Transmisión Manual sin control de estabilidad
MC390968		22.2 mm 7/8"	Toyota Camry LE, XLE 07-08 Transmisión Manual
MC390969		22.2 mm 7/8"	Toyota Camry LE, XLE 07-09 Trasnmisión Automatica
MC390970		22.2 mm 7/8"	Toyota Camry LE, XLE 07-11
MC390983		26.9 mm 1-1/16"	Chevrolet Trail Blazer 06-08, Trail Blazer EXT 06 Nacional, GMC Envoy 06-08, Rainier 06-07 USA
MC390994		25.4 mm 1"	Nissan Frontier 4X4 01
MC390995		25.4 mm 1"	Nissan Frontier 2.4 L 4X4 01
MC391012		26.9 mm 1-1/16"	Chrysler Jeep Liberty 06-07
MC391014		25.4 mm 1"	Mitsubishi Galant ES 2.4 04-09 Con ABS
MC391021		25.4 mm 1"	Cadillac XLR 04-08, Chevrolet Corvette 05-08
MC391032		22.2 mm 7/8"	Chrysler PT Cruiser 05-09 Disco Tambor sin ABS
MC391033		33.3 mm 1-5/16"	Chrysler Dodge Ram 2500 Heavy Duty 05-11, Ram 4000 Heavy Duty 07-10 5.9 Lts V6 Diesel
MC391036		27.0 mm	Volkswagen Touareg 04-09, Volkswagen Transporter 10-13
MC391042		38.1 mm 1-1/2"	Ford F-550 Super Duty 05-07 Diesel con hidrobooster y sin control de frenado integrado
MC391065		23.8 mm 15/16"	Pont:Solstice(2006-2010) Sat:SKY(2007-2010)
MC391068		25.4 mm 1"	Jeep Wrangler 07-14 para disco delantero con diametro de 11.89"
MC391071		20.6 mm 13/16"	Chrysler Dodge Caliber 07-11 Sin ABS
MC391079		1"	Buick Lucerne 06-08, Cadillac DTS 06-08
MC391083		34mm	Cadillac DTS 06-11
MC391099		25.4 mm 1"	Nissan Frontier 11 Nacional, Xterra Transmision Manual 08-10 USA
MC391103		15/16"	Chrysler Town & Country 08-09
MC391123		25.4 mm 1"	Chrysler Dodge Nitro 07-11, Jeep Liberty 08-11, Jeep Wrangler 09-12
MC391124		1 1/16"	Dodge Grand Caravan 08-09
MC391125		25.4 mm 1"	Chrysler 300C 08, Charger 08
MC391127		25.4 mm 1"	Chrysler 300C 09-10, Charger 09-10, Challenger 09-11
MC391129		20.6 mm 13/16"	Ford Fusion 06-07, Mazda 6i 06-08 Nacional, Mercury Milan 06 USA Sin ABS
MC391137		23.8 mm 15/16"	Ford Focus 09-11 Con control de estabilidad
MC391139		27.0 mm	Ford Ranger 07-09
MC391147		26.9 mm 1-1/16"	Chevrolet Acadia 07-14, Traverse 09-14, Buick Enclave 10-14
MC391155		23.8 mm 15/16"	Nissan Tiida Sedan Custom 10-12, Tiida Emotion 10-11, Tiida Comfort 10-12, Tiida HB Emotion 10-12 Tiida HB Premium 10-11, Todos Transmision Automatico Nacional Versa 07-11 USA
MC391158		25.4 mm 1"	Nissan Murano 09-14, Quest 11
MC391160		20.6 mm 13/16"	Ford Fiesta 11-14 Transmisión Automatica
MC391161		33.3 mm 1-5/16"	Ford F-250 Super Duty 11, F-350 Super Duty 11, F-450 Super Duty 11, F-550 Super Duty 11 Con booster de vacio
MC391162		22.2 mm 7/8"	Ford Edge 07-14, Lincoln MKX 07-14
MC391163		38.1 mm 1-1/2"	Ford F-250 Super Duty 11, F-350 Super Duty 11, F-450 Super Duty 11, F-550 Super Duty 11 Con Hidrobooster y control de balanceo de remolque
MC391164		30.1 mm 1-3/16"	Ford F-15 11-14, Lincoln Navigator 10-13
MC391168		38.1 mm 1-1/2"	Chevrolet C-3500 09-13, Express 2500 09-14, Express 3500 09-14, Silverado 2500 HD 09-13, Suburban 2500 09-10 Sin control de freno activo
MC391175		22.2 mm 7/8"	Chevrolet Pontiac G5 09 Nacional, Chevrolet Cobalt 09-10 USA Transmision automatica con programa de control de estabilidad
MC391176		22.2 mm 7/8"	Chevrolet Pontiac G5 09 Nacional, Chevrolet Cobalt 09-10 USA Transmision automatica sin programa de control de estabilidad
MC391177		22.2 mm 7/8"	Chevrolet Pontiac G5 09 Nacional, Chevrolet Cobalt 09-10 USA Transmision manual con programa de control de estabilidad
MC391178		22.2 mm 7/8"	Chevrolet Pontiac G5 09 Nacional, Chevrolet Cobalt 09-10 USA Transmision manual sin programa de control de estabilidad

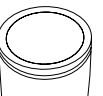



CILINDRO MAESTRO			
No. PARTE LUSAC	No. PARTE RAYBESTOS	DIAMETRO	APLICACIÓN
MC391179		34.0 mm	Chevrolet Express 1500 08 Sin control de freno activo
MC391180		37.0 mm	Chevrolet Suburban 2500 08 GMC Yukon XL 2500 08
MC391181		26.9 mm 1-1/16"	Chevrolet Colorado 09-12, GMC Canyon 09-12
MC391182		25.4 mm 1"	Astra 08-09
MC391187		23.8 mm 15/16"	Pontiac G5 09 Nacional, Chevrolet Cobalt 09-10 manual trans, w/ ss model USA
MC391188		33.3 mm 1-5/16"	Ford F-250 08-10, F-350 08-10, F-450 08-10, F-550 08-10 Con control de freno integral
MC391189		26.9 mm 1-1/16"	Ford Mustang 09-12
MC391190		13/16" & 21/32"	Cadillac Escalade 09-14, Chevrolet Silverado 1500 09-14, Tahoe 08-13, GMC Sierra 1500 09-13, Yukon 08-13, Silverado2500 07-10
MC391192		33.3 mm 1-5/16"	Ford Econoline E-150 09-13, Econoline E-150 Club Wagon 09-14, Econoline E-350 5.4 Lts 09-14 Sin control para activación de freno y/o Control de estabilidad
MC391193		33.3 mm 1-5/16"	Ford Econoline E-150 10, Econoline E-350 5.4 Lts 4X2 09-14 Con control para activación de freno y/o con control de estabilidad
MC391194		33.3 mm 1-5/16"	Ford Econoline E-150 10, E-350 09-11, Econoline E-350 6.8 Lts 4X2 Sin control para activación de freno y/o sin control de estabilidad Rodada sencilla
MC391196		38.1 mm 1-1/2"	Ford F-250 Super Duty 11, F-350 Super Duty 11, F-450 Super Duty 11, F-550 Super Duty 11 Si Hidrobooste y sin control de balanceo de remolque
MC391199		26.9 mm 1-1/16"	Ford Escape hibrida 09-11, Mercury Mariner 09-10
MC391201		26.9 mm 1-1/16"	Ford Escape Sport, XLS, 07-08 Nacional Mazda Tribute 08 Transmision Manual USA
MC391202		26.9 mm 1-1/16"	Ford Escape Sport, XLS, 07-08, Mariner 07-08 Nacional Mazda Tribute 08 Transmision Automatica USA
MC391204		26.9 mm 1-1/16"	Mercury Mariner 08 Nacional, Ford Escape Sport, XLS, 09-11 Transmision Manual USA
MC391205		12.7 mm 1/2"	Lincoln MKS 09-12 Nacional, Ford Flex 09-11 USA
MC391206		30.1 mm 1-3/16"	Ford Expedition 07-09, Lincoln Navigator 07-09
MC391207		22.2 mm 7/8"	Mazda 6i 09-13
MC391210		26.9 mm 1-1/16"	Chrysler 300C 09-14, Dodge Challenger 09-14, Charger 09-14
MC391211		25.4 mm 1"	Chrysler Pacifica 07-08, Town & Country 09-14 Nacional, Dodge Grand Caravan 08-13, Ram Truck:C/V 12 USA
MC391214		22.2 mm 7/8"	Mazda CX 9 07-12
MC391215		23.8 mm 15/16"	Suzuki Grand Vitara 06-11
MC391216		23.8 mm 15/16"	Suzuki Grand Vitara 06-11 Estándar
MC391218		26.9 mm 1-1/16"	Nissan 350Z 03-09
MC391219		20.6 mm 13/16"	Toyota Corolla 09-11, Matrix 09
MC391220		25.4 mm 1"	Mitsubishi Eclipse 09-12, Galant 10-12
MC391221		25.4 mm 1"	Mits:Eclipse(2011
MC391223		13/16"	Mitsubishi Lancer 08-13, Outlander 07-13
MC391224		13/16"	Mitsubishi Lancer 08-09
MC391227		19.0 mm 3/4"	Honda Civic EXL 08-11
MC391235		25.4 mm 1"	GMC Terrain 11-14 Nacional, Chevrolet Equinox 11 USA
MC391237		22.2 mm 7/8"	Ford Fusion 10-12, Lincoln MKZ 11-12, Mercury Milan 10-12
MC391238		20.6 mm 13/16"	Ford Fiesta 11-14 Transmisión Estándar
MC391246		26.9 mm 1-1/16"	Chevrolet Camaro V8 10-14 Nacional, Caprice 11 USA
MC391247		25.4 mm 1"	Chevrolet Camaro V6 10-14
MC391251		34.0 mm	Chevrolet Express 1500 08 Con control de freno activo
MC391252		33.3 mm 1-5/16"	Chevrolet Express 1500 09-11 Con control de freno activo
MC391253		33.3 mm 1-5/16"	Chevrolet Express 1500 09-11 Sin control de freno activo
MC391254		23.8 mm 15/16"	Ford Transit Connect 09-10
MC391255		26.9 mm 1-1/16"	Ford Freestar 06-07 Sin control de tracc
MC391256		27.0 mm	Ford Ranger 10-11
MC391257		33.3 mm 1-5/16"	Ford Econoline E-350 08 con programa de control de estabilidad
MC391258		22.2 mm 7/8"	Mazda CX 7 07-12
MC391259		1"	Infiniti G35 05-07, M35 06-10, M37 11-13, M45 06-10, M56 11-13
MC391260		23.8 mm 15/16"	Mitsubishi Lancer Evolution GSR 08-11
MC391261		23.8 mm 15/16"	Mitsubishi Lancer Evolution MR y Tuning 08-10
MC391263		22.2 mm 7/8"	Suzuki SX4 08-11 Transmisión Manual sin control de estabilidad
MC391264		22.2 mm 7/8"	Suzuki SX4 08-11 Transmisión Automatica sin control de estabilidad
MC391265		22.2 mm 7/8"	Suzuki SX4 08-11 Transmisión Manual con control de estabilidad
MC391266		22.2 mm 7/8"	Suzuki SX4 08-11 Transmisión Automatica con control de estabilidad



CILINDRO MAESTRO			
No. PARTE LUSAC	No. PARTE RAYBESTOS	DIAMETRO	APLICACIÓN
MC391267		23.8 mm 15/16"	Nissan Rogue 08-12
MC391268		1"	Infiniti FX35 09-12, FX37 13, FX50 09-13, QX70 14
MC391269		1"	Infiniti EX35 08-12, EX37 2013, G35 07-08, G37 09-13, Q60 14, QX50 14, Nissan 370Z 09-16
MC391270		15/16"	Infiniti G35 07-08, G36 08-13, Q60 14
MC391271		23.8 mm 15/16"	Chrysler Dodge Journey 09-14
MC391294		13/16"	Toyota Tacoma 09-14
MC391295		13/16"	Toyota Tacoma 09-14
MC391296		22.2 mm 7/8"	Toyota Rav-4 10-11 que no sea fabricado en Japon
MC391299		20.6 mm 13/16"	Toyota Rav 4 06-11
MC391303		25.4 mm 1"	Nissan Frontier SE 4X4 Transmision Automatica 08-13, Pathfinder 10-12 Nacional, Xterra 08-13, Suzuki Equator 09-12 USA
MC391308		23.8 mm 15/16"	Nissan Altima 2.5 Lts 08-11
MC391309		23.8 mm 15/16"	Nissan Altima 2.5 Lts 08-10
MC391310		23.8 mm 15/16"	Nissan Altima 3.5Lts 08-14, Maxima 09-14
MC391311		23.8 mm 15/16"	Nissan Altima 07-14
MC391314		22.2 mm 7/8"	Chev:Cobalt(2008) Pont:G5(2008)
MC391315		22.2 mm 7/8"	Chev:Cobalt(2008) Pont:G5(2008)
MC391316		7/8"	Acura RDX 07-12
MC391319		26.9 mm 1-1/16"	Ford Mustang 10-14
MC391322		25.4 mm 1"	Mitsubishi Galant 06-09
MC391323		23.8 mm 15/16"	Subaru Legacy 06-08, Outback 06-08
MC391325		26.9 mm 1-1/16"	BMW X5 07-12, X6 11-12
MC391341		25.4 mm 1"	Nissan Murano 04-08 Sin control de estabilidad
MC391342		25.4 mm 1"	Nissan Murano 04-05 con control de estabilidad
MC391343		25.4 mm 1"	Nissan Murano 06-07 Con control dinamico de estabilidad
MC391344		25.4 mm 1"	Mitsubishi L200 Sin ABS 07-11, Endeavor 04-08 Tracción en todas las ruedas y con control de Estabilidad del Vehículo
MC391346		22.2 mm 7/8"	Audi:A3(2004-2011) VW:Golf(2007,2010-2011)
MC391347		15/16"	Nissan Cube 09-14, Juke 11-14
MC391350		25.4 mm 1"	Mits:Eclipse(2006-2009)
MC391351		25.4 mm 1"	Mits:Galant(2006-2008)
MC391353		7/8"	Mini Cooper 02-08
MC391359		30.1 mm 1-3/16"	Ford F-15 10, Lincoln Navigator 10, Ford Expedition 10
MC391363		19.0 mm 3/4"	Honda Fit 11-13 Nacional, Insight 10-14 USA
MC391364		22.2 mm 7/8"	Honda Odyssey 11-12
MC391365		1" & 7/8"	BMW 135i 09-13, 323i(2008-2010),328i 12-13, 335d(2009-2011),335i 09-14 ,335ci 01-14, X1 10-14
MC391366		23.8 mm 15/16"	Mini:Cooper(2007-2011),Cooper S(2007-2011)
MC391376		20.6 mm 13/16"	Toyota Yaris 10-12
MC391377		1"	Mazda 3 07-13
MC391378		22.2 mm 7/8"	Acura TL 09-13, Honda Accord Crosstour 10-12
MC391384		23.8 mm 15/16"	Audi TT 03-06, Seat Leon Cupra 2.0 Lts 07
MC391387		25.4 mm 1"	Ford Focus 12-14, Escape 13-14
MC391393		26.9 mm 1-1/16"	Audi A6 05-11
MC391394		1" & 7/8"	BMW X3 04-11
MC391400		25.4 mm 1"	Saab 9-3 03-09
MC391401		15/16"	Nissan Versa 11-12
MC391402		N/D	Nissan Sentra 11-12
MC391403		N/D	Nissan Sentra 10-12
MC391411		26.9 mm 1-1/16"	Nissan Pathfinder 08-12
MC39800		23.8 mm 15/16"	Nissan 240SX Sin ABS 93
MC97071		23.8 mm 15/16"	Volkswagen Combi-Panel 88-01
MIS55214		22.2 mm 7/8"	Ford KA 01-08
XF5Z2140	MC390115	25.4 mm 1"	Nissan Quest XE 97-03 con ABS Nacional, Ford Mercury Villager con ABS 99-00 USA.

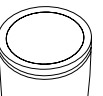



CUBREPOLVOS PARA RUEDAS		
No. PARTE LUSAC	DIAMETRO	APLICACIÓN
100	17.4 mm 11/16"	V.W. Sedan
101	19.0 mm 3/4"	V.W. Sedan
102	22.2 mm 7/8"	V.W. Cmta. Tipo Arillo
103	25.4 mm 1"	V.W. Cmta. Tipo Arillo
104	23.8 mm 15/16"	V.W. Combi Tipo Arillo
105	14.2 mm 9/16"	V.W. Caribe Tipo Arillo
106	17.4 mm 11/16"	V.W. Caribe Aut. Y Atlantic. Tipo Arillo
107	22.2 mm 7/8"	V.W. Sedan
110	19.0 mm 3/4"	Cubre Polvo V.W. Sedan
112	19.0 mm 3/4"	Cubre Polvo V.W. Cmta.
113	22.2 mm 7/8"	Cubre Polvo V.W. Sedan
114	19.0 mm 3/4"	Cubre Polvo V.W. Sedan
115	23.8 mm 15/16"	Cubre Polvo V.W. Combi
116	14.2 mm 9/16"	Cubre Polvo V.W. Caribe
117	17.4 mm 11/16"	Cubre Polvo V.W. Caribe Aut. y Atlantic
121	15.8 mm 5/8"	Toyota. Tipo Copa
200	22.2 mm 7/8"	Fiat. Tipo Arillo
210	28.5 mm 1-1/8"	Cubre Polvo Fiat
211	15/16", 13/16"	Cubre Polvo Fiat y Renault
302	31.7 mm 1-1/4"	Volvo Tipo Arillo
368	34.9 mm 1-3/8"	Cubre Polvo
401	26.9 mm 1-1/16"	Opel. Tipo Arillo
410	1/16", 31/32"	Cubre Polvo Opel
510	20.6 mm 13/16"	Cubre Polvo Renault y Datsun
602	22.2 mm 7/8"	Cubre Polvo Datsun
603	25.4 mm 1"	Cubre Polvo Datsun
610	15.8 mm 5/8"	Datsun Sedan. Tipo Arillo
611	22.2 mm 7/8"	Datsun Sedan. Tipo Arillo
612	23.8 mm 15/16"	Datsun Sedan. Tipo Arillo
613	20.6 mm 13/16"	Datsun Sedan Vagoneta Ichi-Van y Samurai
614	19.0 mm 3/4"	Datsun Cmta. Estaquitas, Pick Up
700	20.6 mm 13/16"	V.W. Safari, Taurus. Tipo Arillo
701	19.0 mm 3/4"	V.W. Taurus. Tipo Arillo
2530	15.8 mm 5/8"	Chrysler Codigo "K". Tipo Copa
2937	7/8", 15/16"	(29/32", 1 1/8", 1") Cubre Polvo
4109	1-1/4", 1-3/16"	Cubre Polvo
4685	38.1 mm 1-1/2"	Cubre Polvo
10590	28.5 mm 1-1/8"	Cubre Polvo
10675	28.5 mm 1-1/8"	Cubre Polvo
12058	41.3 mm 1-5/8"	Cubre Polvo
14492	29/32", 1 3/16"	Cubre Polvo *(1 1/8", 1 1/32", 15/16", 7/8", 1")
16930	38.1 mm 1-1/2"	Cubre Polvo
16932	13/16", 27/32"	Cubre Polvo
19114	1-5/8", 1-3/4"	Cubre Polvo
49260	22.2 mm 7/8"	Cubre Polvo Chev. Para Cil. con Diametro (Ver Medida)
49261	23.8 mm 15/16"	Cubre Polvo Chev. Opel Para Cil. con Diametro (Ver Medida)
49262	26.9 mm 1-1/16"	Cubre Polvo Chev. Varios Para Cil. con Diametro (Ver Medida)
51123	30.1 mm 1-3/16"	Cubre Polvo Chev.Cmtas. Cil. con Diametro (Ver Medida)
5976C	38.1 mm 1-1/2"	Cubre Polvo
80023	28.5 mm 1-1/8"	Izuzu Tipo Arillo
40123R	28.5 mm 1-1/8"	Toyota. Tipo Arillo
401R	26.9 mm 1-1/16"	Opel. Reforzada Tipo Arillo
4511R	15.8 mm 5/8 "	Toyota. Tipo Arillo
4514R	17.4 mm 11/16 "	Toyota. Tipo Arillo
4518R	25.4 mm 1"	Datsun, Toyota. Tipo Arillo
7064R	20.6 mm 13/16 "	Toyota. Tipo Arillo
80203A	36.0 mm 1-7/16"	Izuzu. Tipo Arillo (Del.)



GOMAS PARA FRENOS HIDRÁULICOS		
No. PARTE LUSAC	DIAMETRO	APLICACIÓN
666	31.7 mm 1-1/4"	Goma Estriada
725	38.1 mm 1-1/2"	Goma Estriada
857	34.9 mm 1-3/8"	Goma Estriada
966	44.4 mm 1-3/4"	Goma Estriada
1219	26.9 mm 1-1/16"	Goma Estriada
1499	25.4 mm 1"	Goma Estriada
2230	50.8 mm 2"	Goma Estriada
2936	28.5 mm 1-1/8"	Goma Estriada
3023	22.2 mm 7/8"	Goma Estriada
3535	23.8 mm 15/16"	Goma Estriada
4158	19.0 mm 3/4"	Goma Estriada
4600	30.1 mm 1-3/16"	Goma Estriada
5174	27.7 mm 1-3/32"	Goma Estriada
8807	38.1 mm 1-1/2"	Goma Tipo Arillo
9700	28.5 mm 1-1/8"	Goma Tipo Arillo
12000	33.3 mm 1-5/16"	Goma Estriada
12360	41.3 mm 1-5/8"	Goma Estriada
12400	20.6 mm 13/16"	Goma Estriada
14507	38.1 mm 1-1/2"	Goma Tipo Arillo
19000	24.6 mm 31/32"	Goma Estriada
27000	23.0 mm 29/32"	Goma Estriada
42103	21.4 mm 27/32"	Goma Estriada
14507R	38.1 mm 1-1/2"	Goma Tipo Arillo Reforzada





KIT DE PISTÓN Y REPUESTO FD				
No. PARTE KIT	No. DE PISTÓN	No. REPUESTO FD	DIÁMETRO	APLICACIÓN
742301	851007	21007	42.8mm 1 11/16	Mitsubishi Outlander L/N Doble Piston 07-10, Montero Doble Piston 03-09 Delantero
742302	851008	1458	57.1 mm 2-1/4"	Suzuki Grand Vitara 06, Gran vitara GL 06-10, Suzuki SX-4 07-09 Delantero
742303	851018	1458	57.1 mm 2-1/4"	Chevrolet. Geo Tracker 07-08 Delantero
742304	851041	21041	63.5 mm 2-1/2"	Mitsubishi Endeavor 04-11 Delantero
742305	851024	21024	54.0 mm 2-1/8"	Ford F-150 06-10, Lobo 06-10 Delantero caliper de 2 pistones
742306	851025	21025	51.0 mm	Ford F-150 06-10, Lobo 06-10 Trasero
742307	851026	21078	57.1mm 2-1/4"	Mitsubishi Lancer 06-10 5 Birlos, Delantero
742308	851026	21999	57.1 mm 2-1/4"	Honda Accord Sedan 07-11 Delantero
742309	851021	21021	42.0mm	Chrysler Dodge Charger 06-09 Delantero y Trasero
742310	853262	2476	38.1 mm 1-1/2"	Toyota Rav-4 limited, Base 08-10, Camry Tras 07-11 Trasero
742311	851029	21041	45.5 mm.	Honda CR-V 07-10, Odyssey 09-10 Delantero
742312	851004	21004	57.1 mm 2-1/4"	Chevrolet Vectra 03-08 4cil Delantero
742324	108159	108241	60.0 mm	Chrysler Concorde 93-97 Y 01-02, Imperial 91, Intrepid 94-01, Le Baron 92-95, New Yorker 90-94, New Yorker LH, LHS 94-97, Phantom 90-94, Spirit R/T 91-95, 300 M 99-04, Grand Voyager 91-00, Town & Country 93-00, Voyager 94-00, Ford Ghia 91-94, Topaz 84-94, Nissan Quest Xe 97-02. Delantero
742325	107534	102443	54.0 mm 2-1/8"	Chrysler Dart "K" y Guayin 82-88, Dart "E" 89, Le Baron "K" 83-87, Magnum "K" 83-88, Neon 95-05. New Yorker 85-89, Phantom 87-89, Serie 600 "K" 84-85, Shadow 89-94, Shadow GTS Turbo 89, Spirit 90-95, Volare "K" 82-88, Delantero caliper sencillo, Ram Van 1500 98-03, Ram Wagon 150098-03, Ram 1500 01-08, Ram 2500 01-04, Ram Van 2500 98-02, Ram Wagon 2500 98-02, RamCharger 00-01. Delantero Caliper Doble piston, Ram 1500 03-08, Ram Van 1500 02-03, RamWagon 1500 02-03, Caliper trasero sencillo.
742326	107534	2473	54.0 mm 2-1/8"	Chrysler Dodge Durango 03-04 Tras., Durango SLT, Durango Limited 05-06, Ram-1500 03-08Del/Tras., Ram Van 1500, Ram Wagon 1500 02-03, Ram-2500, Ram-2500 Quad Cab 03-04, Aspen 07-09 Trasero Caliper sencillo.
742327	85177	1668	42.8 mm 1-11/16"	Nissan NP300 09-12, Pathfinder XE 97-98. Pick Up D-21 92-10. Pick-Up Doble Cabina 97-10. PickUp Corto 90-00. Pick-Up King Cab 95-00. Pick-Up Largo 97-10. Pick-Up 250 94-96, Estaquitas Pick Up 72-10, Nissan Cta. Frontier 4 cil. 00-04, Urvan 00-01 Delantero Caliper Doble Piston.
742328	85055	1565	66.7 mm 2-5/8"	Ford Aerostar 91-95. Explorer XLS V6, XLT V8, Limited. 91-94. Delantero
742329	85817	2817	48.0 mm 1-57/64"	Ford F-150 97-03, F-150 XL 04 Delantero
742330	85815	2815	54.0 mm 2-1/8"	Ford Excursion 4X2 y 4X4 01-05. F- 250, F-250 y Super Duty 99-04 Doble piston Delantero F-350Super Duty 99-04 Ford Triton 99-03. Doble piston Delantero Trasero
742331	6000	641	48.0 mm 1-57/64"	Nissan Hikari 88-92, Ninja Turbo 86-87, Sakura 85-86, Samurai 81-87, Tsuru I 84-87, Tsuru II 88-92, Tsuru GS 93-14, Tsubame 93-04, Sentra 1.6 Lts. 92. Delantero
742332	6000	21020	48.0 mm 1-57/64"	Chevrolet Trail Blazer 4X2 LS, LT, 4X4 02- 06. Trail Blazer 4X4 EXT. 04- 06 Trasero Sello gruesopara caliper Delphi, sello delgado para caliper GM
742333	6000	1562	48.0 mm 1-57/64"	Chevrolet Geo Tracker 93-95 y 98-06. Delantero.
742334	76027	83691	65.9 mm 2-19/32"	Chrysler Dart 73-76, Valiant Duster 73-76, Ford Maverick 74-77. Mustang 74-78, VAM American 77-83, Classic 76 Sin Boster, Rally 76-83, Jeep CJ-5 78. Delantero
742335	76024	76090	73.0 mm 2-7/8"	Ford F- 100 73-79, F-150 84-85 y 90-91, P-350 Microbus 77-78. Caliper de Un Piston. Delantero.
742336	76024	1838	73.0 mm 2-7/8"	Ford F-150 86-89 y 92-93, F-200 2A. Versión 86, Caliper de Un Piston. Delantero.
742337	850300	2154	55.9 mm 2-13/64"	Chrysler Ram Vam 3500, Ram Wagon 3500 98-02 Ram 4000 00-02 y 05-06, Delantero Caliper DoblePiston.

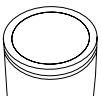



KIT DE PISTÓN Y REPUESTO FD				
No. PARTE KIT	No. DE PISTÓN	No. REPUESTO FD	DIÁMETRO	APLICACIÓN
742338	850300	2885	55.9 mm 2-13/64"	Ford Club Wagon V8 E-250 95-96. Club Wagon V8 E-250 Chateau 95-96 y 98-00. Econoline ClubWagon V8 E-350 XL 99-06, Econoline Club Wagon V8 E-350 XL 95-96. Econoline Van E-250 97-99. Econoline Van E-350 98-99 y 06-07. Econoline Van E-350 Diesel 06-07, F-350 95-04. F-250 95-97, P-350 Microbus 94-97. Caliper doble piston Delantero.
742339	85438	83691	65.9 mm 2-19/32"	Ford Lincoln Continental 97-99, Lincoln Town Car 95-00, Lincoln Mark VIII 94-96, Sable 94-04. SableVagoneta 94-97. Windstar GL, LX 95-98. Delantero.
742340	85438	1837	65.9 mm 2-19/32"	Ford Grand Marquis 95-97. Lincoln Town Car ABS. 95-00. Mustnag GT 98 Delantero
742341	99980	88562D	55.6 mm 2-3/16"	Ford F-200 86-91, F-350 73-92, P-350 76-91. Delantero.
742342	99980	2730	55.6 mm 2-3/16"	Ford F-250 92-94. F-350 93-94. P-35, P-350 Microbus 89-95. Delantero.
742343	99980	88562S	55.6 mm 2-3/16"	Ford F-250 92-94. F-350 93-94. P-35, P-350 Microbus 89-95. Delantero.
742344	2160	2159	50.8 mm 2"	Chevrolet Express 1500 07-14 de 6 Birlos, Silverado 1500 4 X 2 4 X 4 00-01 y 03-06. Silverado 2500 4 X 2 4 X 4 00-01 y 03-10. Silverado 3500 4 X 2, 4 X 4 96-05. Silverado 3500 HD 4 X 2, 4 X 4 96-06. Suburban 00-06, Trasero, Chevrolet Sonora 00-06, Cheyenne C-20, C-25 01-06 Delantero. Caliper Doble Piston
742345	85392	1473	66.0 mm	Jeep Cherokee Sport 94 y 98-01, Jeep Grand Cherokee 93-98, Jeep Wrangler 93-02, Jeep Wrangler-Sahara 97-02, Jeep Wrangler Unlimited, Jeep Wrangler Rubicon 03-06, Caliper ATE Delantero.
742346	85392	21080	66.0 mm	Chrysler Town & Country 01-07, Voyager 01-08 Disco Disco Nacional Caravan 01-07 USA CaliperATE Delantero
742347	96542	642	60.3 mm 2-3/8"	Nissan Ichi Van 87-94, Estaquitas 72-03. Pick Up D-21 92-03. Pick-Up Doble Cabina 82-00. Pick UpCorto 90-00. Pick -Up King Cab 95-00. Pick-Up Largo 97-03. Pick-Up 250 94-96, MitsubishiOutlander 04-06, Mitsubishi Eclipse 06-09 Delantero
742348	96542	2478	60.3 mm 2-3/8"	Nissan Ichi Van 87-94, Estaquitas 72-03. Pick Up D-21 92-03. Pick-Up Doble Cabina 82-00. Pick Up-Corto 90-00. Pick -Up King Cab 95-00. Pick-Up Largo 97-03. Pick-Up 250 94-96. Delantero
742349	85814	2814	48.0 mm 1-57/64"	Ford Windstar 99-03 Delantero
742350	85471	20930	59.5 mm 2-11/32"	Ford F-450 V10 Super Duty 99-13, F-450 V8 Diesel Super Duty 05-13, F-550 V10 Super Duty 01-13. Del y Tras caliper doble piston Cubrepolvo duro, Internacional CF500 06-13, CF600 06-13 Delantero y trasero
742351	85157	2005	74.6 mm 2-15/16"	Chevrolet Suburban 88-00, Blazer Nevada 92-94. C-15 94-99, C-20, C-25 y Cheyenne 92-01, C-3500 02-08, G-15 98-01. G-15 Express 1500, Express Cargo Van 1500. 98-01, y 03-06 Doble piston. Express 2500, Express Cargo Van 2500. 99-06, Maxi Cab 91-93. Silverado 1500 95-99, ChryslerRam Charger 99, Ram 1500 94-00, Ram 2500 91-00, Ram Runner V-10 96-97. Delantero Caliper sencillo, Avalanche 02-06. Cadillac De Ville 90-93, 97-99, Cadillac Escalade 02-06. Cadillac Escalade Ext 03-06. Silverado 1500 00-01 y 03-06. Silverado 1500 00-01 y 03-06. Silverado 2500 00-01 y 03-06. Silverado 3500 96-06. Sonora 00-06. Suburban 00-06 G-15 02-05. G-15 Express 1500, Express Cargo Van 1500. 02-06. Express 2500, Express Cargo Van 2500. 02-06. Delantero Caliper doble piston
742352	85019	1838	73.0 mm 2-7/8"	Ford Club Wagon V6 E-150 95-03. Club Wagon V8 E-250 97-04. Econoline Van E-150 95-07, Econoline Wagon E-350 Diesel 01 y 03, Club Wagon V8 E-350 97-98. F-150 94-99. Delantero
742353	85155	1966	59.5 mm 2-11/32"	Ford Econoline E-350 99 y 06-07. Econoline E-350 Van Diesel 06-07, Club Wagon V8 E-250 95-96, Club Wagon V8 E-250 Chateau 99-00. Econoline Club Wagon V8 E-350 XL 99-06, Club Wagon V8 E-350 XL 95-96. Trasero F-450 V8 Super Duty 97-02. Delantero. y Trasero caliper doble piston. Cubrepolvo suave
742354	851023	21023	60.0 mm	Ford F-350 Super Duty 05-11, F-350 Super Duty King Ranch 05-11, F-350 Super Duty Lariat 05-11, F-350 Super Duty XL 05-11, F-350 Super Duty XLT 05-11, F-350 Super Duty FX4 08-09 F-350, F-450 Super Duty 2011 Caliper doble piston Delantero Cubre polvo Suave

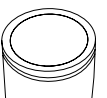



KIT DE PISTÓN Y REPUESTO FD				
No. PARTE KIT	No. DE PISTÓN	No. REPUESTO FD	DIÁMETRO	APLICACIÓN
742355	851022	21022	54.0 mm 2-1/8"	Ford F-350 Super Duty 05-11, F-350 Super Duty King Ranch 05-11, F-350 Super Duty Lariat 05-11, F-350 Super Duty XL 05-11, F-350 Super Duty XLT 05-11, F-350 Super Duty FX4 08-09 F-350, F-450 Super Duty 2011 Caliper doble piston Trasero Cubre Polvo Duro
742356	832	124	48.0 mm 1-57/64"	Chevrolet Chevy Joy 94-03. Chevy Swing 94-03, Chevy Monza 97-03. Chevy Pop 96-03. Chevy Vagoneta 00-03. Chevy Pick Up 99-04 Chevy C2 04-10, Chevy C2 Sedan 05-07 Delantero.
742357	76008	59176	74.6 mm 2-15/16"	Chevrolet Blazer Nevada 91. Caprice 78-82, Chevelle 70-75, Chevelle Malibu 70-75, Chevy Nova 73-78, Impala 70-75, C-10 71-78, C-15 82-87, C-20, 25 79-87. C-30, 35 71-78. G-20 95. Suburban 87-88, Dina 1000 77-83, Dina 3000, 3200 77-83, VAM Wagonner 77-86. Wagoneer J-164 74-76 Delantero
742359	76021	76390	78.6 mm 3-3/32"	Ford Ltd 75-78 Delantero
742360			78.6 mm 3-3/32"	Chrysler Monaco 74-77. D-100 73-80. D-150 81-93, D-250 86-93, D-300 72-80, D-350 81-93, Microbus 81-93, M-300 78, W-150 85-87, W-250 4X4 86-93. Delantero.
742361	76025	83691	65.9 mm 2-19/32"	Ford F - 150 80-83. Delantero
742362	76026	810	78.6 mm 3-3/32"	Dina Camta. 1000 75-77. Delantero.
742363	76026	76390	78.6 mm 3-3/32"	Chrysler M-300 80. Delantero.
742364	76026	101491	78.6 mm 3-3/32"	Chrysler M-300 78, Ram Charger 86-96, Ram Van 1500 95-97. Ram Wagon 1500 95-97. Ram Van 2500 96-97. Ram Wagon 2500 96-97. Ram Van 3500 96-97. Ram Wagon 3500 96-97. Delantero.
742365	76028	815	85.7 mm 3-3/8"	Dina Camta. 3000, 3200 75-77 Delantero.
742366			85.7 mm 3-3/8"	Chevrolet C-30, C-35 84-87, C-35, C-3500, C-3500 HD 96-00, Microbus 88-00, Panel P-30 82-92 y 94-98 Delantero, Chevrolet C-30, C35 96-00 Trasero.
742367	76033	99024	63.5 mm 2-1/2"	Chevrolet Silhouette 91-92 y 94-95, Chevrolet Blazer 95-97, Chevelle Malibu 79-81. Monte Carlo 81-84, Century 83-96, Cutlass 90-96, Cutlass Eurosport 90-96, S-10 Pick Up 95-04 Delantero
742368	85013	2827	50.8 mm 2"	Ford F-150 97-99, Ford Lobo 150 Y 250 99-04 s/c vel, Ford F-250 Sup. Duty 4x4 03-04, Ford Lincoln-Blackwood 03 Caliper Doble Piston Delantero.
742369	85119	2119	45.0 mm	Chevrolet Trail Blazer 02-06 Delantero. Chevrolet Sonora 00-06 Trasero. Chevrolet Avalanche 4x2 02-03 Trasero. Chevrolet Avalanche 4x4 02-04 Trasero. Chevrolet Avalanche 4x4 02-04 Tras. Chevrolet Avalanche 4x4 V8 5.3 Lts. 05-06 Trasero. Cadillac Escalade 2x4 5.3 Lts. 02-06 Trasero Cadillac Escalade 4x4 6.0 Lts. 02-06 Trasero Cadillac Escalade EXT 4x4 03-06 Trasero. Chevrolet Suburban 1500 00-04 Caliper doble piston Delantero Cubre polvo duro
742370	85119	2275	45.0 mm	Ford Mustang GT 98-04. Caliper doble piston Delantero.
742371	85152	2152	64.0 mm	Chrysler Grand Voyager 01-06, Town & Country 01-07. Voyager 01-07 Delantero Disco Tambor.
742372	85152	21160	64.0 mm	Pontiac Aztek 4X4 01-05 Delantero
742373	85153	1473	66.0 mm	Jeep Liberty 02-13. Delantero
742374	85456	2477	48.0 mm 1-57/64"	Ford Explorer XLS V6, XLT V8, Limited s/cont/vel 95-10 Tras. Explorer Sport s/c de tracc, y c/c de tracc. 4x2 94-95 y 98-03, Lincoln Aviator 03-05, Jeep Liberty 03-13 Tras, Jeep Wrangler, Jeep Wrangler Sahara, Jeep Wrangler Rubicon 03-06 Jeep Gran Cherokee 95-98 Trasero
742375	85469	2845	54.0 mm 2-1/8"	Chrysler Breeze 96. Cirrus 96-00. Cirrus Coupe 99-00. Cirrus Convertible 01-05. Sebring 97. Stratus 95-97, Stratus R-14 95-00, Stratus R-15 96-97. Delantero
742376	85477	2817	48.0 mm 1-57/64"	Ford Grand Marquis 98-04. Lincoln Town Car 98-07, F-150 97-04 Caliper doble piston Delantero
742377	85486	2486	47.6 mm 1-7/8"	Nissan Urvan 00-10, Nissan Quest V6 305 L 04-09, Caliper Doble Piston Delantero
742378	85826	2826	50.8 mm 2"	Ford Expedition XLT 97-02, Expedition Eddie Bauer 97-02, F-250, F-250 Super Duty 98-02. Lincoln Navigator 98-02. Doble piston Delantero

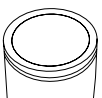



KIT DE PISTÓN Y REPUESTO FD				
No. PARTE KIT	No. DE PISTÓN	No. REPUESTO FD	DIÁMETRO	APLICACIÓN
742379	85827	2827	50.8 mm 2"	Ford Expedition 97-02, F-150 97-04, F-250 97-02, Ford F-250 Sup. Duty 4x4 03-04, Ford Lobo 150 Y250 97-04, Lincoln Town Car 03-06, Navigator 98-02 Caliper sencillo trasero
742380	85857	2857	46.0 mm 1-13/16"	Chevrolet Equinox 05-08, Ford Explorer XLS V6, XLT V8, Limited. 95-02. Ranger 96-11 Doble piston Delantero
742381	96363	127	40.0 mm	Volkswagen Brasilia 74-82, Sedan 95-04 Delantero.
742382	96373	126	54.0 mm 2-1/8"	Volkswagen Combi Panel 73-01.calibrador ATE Delantero
742383	115614	112486	65.9 mm 2-19/32"	Ford Taurus 88-91,Delantero
742384	850450	2045	48.0 mm 1-57/64"	Chrysler Jeep Commander 06-10, Jeep Grand che-rookee 99-10 Delantero.caliper doble piston Te-vesdoble piston, Jeep Commander 06-10, Jeep Grand cherokee 99-10 Trasero Caliper sencillo
742385	851110	2111	44.4 mm 1-3/4"	Chevrolet Suburban 1500 04-06, Expres 1500 07-14 de 6 Birlos, Express 2500 Express Cargo van2500 02-06, Express 3500 Express Cargo van 3500 02-14 Chevro-let Sonora 00-06, Caliper doble piston Trasero
742386	98728	124	48.0 mm 1-57/64"	Volkswagen Golf A-3 CL, GL. 93-99. Golf A-2 C, CL, GL 87-92. Golf A-3 GLS 93-99. Golf Cabrio A-3 96-99. Golf GTI A-2 89-92. Jetta A-2 87-92. Jetta A-3 CL, GL. 93-99. Corsar 85-88, Corsar Variant 86-88. Derby 95-00, Volkswagen Van 03-09 Delantero.
742387	85812	1449	54.0 mm 2-1/8"	Fiat Palio Adventure 04-11, Fiat Palio Sedan 04-08, Ford Eco Sport 04-10, Fiesta 98-01 y 03-06, Fiesta Sedan 05-06, Fiesta Sedan First, Fiesta Sedan Trend 07-14, Fiesta Ikon 01-07, KA 01-03, KA Sport 04-08, Courier Pick up 01-10 Del. Para autos que llevan la balata 7259-D649, Mazda Mazda2 12-14 Delantero
742388	2904	102443	54.0 mm 2-1/8"	Volkswagen. Pointer 98-10. Pointer City 00-10. Pointer MI 2.0 Lts. 03-04, Pointer GTI 00-02, PointerVagoneta 99-04. Delantero
742389	85860	1449	54.0 mm 2-1/8"	Peugeot Partner 04-08, Renault Megane 01-03, Megane II 03-07, Megane II Sedan 04-07, Megane II Coupe Convertible 05-07, Megane II Sport 07, Scenic 01-09, Seat Cordoba 01-09, Ibiza 01-09, Toledo 01-03, Volkswagen Derby 01-09, Golf A4 Cabrio 00-02, Golf A3 GTI 93-98, Golf A3 GTI VR6 95-99, Jetta A3 GLS, Jetta A3 Europa 93-99, Eurovan VR6 2.8 LTS 00-02, Volkswagen Passat 91-93, Passat Vagoneta 91-92, Volkswagen Van 03-09 Delantero
742390	85860	2500	54.0 mm 2-1/8"	Peugeot 206 00-07, 206 XR 00-07, 206 XT 03-07, 307 03-07 Delantero
742391	85860	2801	54.0 mm 2-1/8"	Seat Alhambra 02-03, Volkswagen Passat 99-05 Delantero
742392	850700	2070	48.0 mm 1-57/64"	Ford Explorer 03-05, Ford Explorer Sport 94-95 y 98-03, Ford Ranger 04-07. Caliper doblepiston Delantero.
742393	2902	1449	54.0 mm 2-1/8"	Seat Alhambra 02-03, Cordoba 01-08, Ibiza 01-08, Toledo 01-03, Seat León Signo 03-04, LeónReference 07-10, León Stella 03-04, León Stylace 05-10, León Cupra 05-10, Volkwa-gen Beetle 1.8,2.0 98-10, Golf A3 GTI VR6 95-99. Golf A4 00-03.Golf GTI A4 00-05, Jetta VR6 2.8 Lts A-3 95-99. Jetta A4 00-10. Jetta VR6 96-04. Passat VR6 96-97. Pas-sat y Passat Wagon 96-97, Golf GTI A-32.0 L S/ABS 99, Golf GTI A-4 2.0 L S/ABS 00-05, Beetle Turbo 1.8L 00-05, Polo 03-07, Lupo 05- 07, Cross Fox 07-11 Delantero
742394	2900	2901	48.0 mm 1-57/64"	Volkswagen Pointer 98-10. Pointer City 00-10, Pointer Treanline 06-10 Pointer Vagoneta 99-02,Pointer Pick Up 99-07 Delantero
742395	851470	21470	34.9 mm 1-3/8"	Nissan Xtrail 02-10, Altima 02-10, Maxima 04-08 Trasero
742396	85476	2476	38.1 mm 1-1/2"	Chevrolet Venture APV 98-04, Pontiac Montana SV6 05-07,Tor-rent 06, Pontiac Aztek 01-05 4x4, Chevrolet Impala C/S/ABS 00-04, Grand Prix GT, GTP, Se. 97-01,Toyota Camry 02-11, Toyota Solara 05-07, Mitsubishi Outlander 04-10 4 cil. 2.4L, Honda Pilot 03-08 Trasero Cubre polvo Suave
742397	85402	21017	54.0 mm 2-1/8"	Nissan Tiida 07-13 Delantero
742398	85472	1458	57.1 mm 2-1/4"	Nissan Altima 96-12, Maxima 00-14, 240 SX 93-98,Infiniti I-30 00-01 Delantero.
742399	851330	21078	57.1 mm 2-1/4"	Chrysler 200 12-14, Dodge Avenger 08-14, Cali-ber 07-12, Cirrus 06-10, Lancer 06-10, Jeep Pa-triot07-14, Jeep Compas 07-14, Delantero

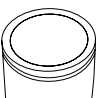



KIT DE PISTÓN Y REPUESTO FD

No. PARTE KIT	No. DE PISTÓN	No. REPUESTO FD	DIÁMETRO	APLICACIÓN
742400	851015	21015	57.1 mm 2-1/4"	Mazda 3 Sedan i 06-14, Mazda 3 Sedan s 06-14, Mazda 3 HB s 06-14, Mazda 5 06-12, VolkswagenSharan 02-08 Delantero
742401	853271	23271	32.1 mm 1-17/64"	Toyota Rav4 Base y Limited 04-10 Trasero
742402	851015	21996	57.1 mm 2-1/4"	Ford Focus 07-11, Focus Europa L/N 07-09 Delantero
742403	851001	21001	63.5 mm 2-1/2"	Nissan Murano S, Murano SL, Murano SE 04-10 Delantero
742404	85391	21981	57.1 mm 2-1/4"	Volkswagen Passat 07-10 L/N Delantero
742405	851016	21016	57.1 mm 2-1/4"	Isuzu ELF 300 08-09, ELF 400 07-09, ELF 450 4 Cilindros Diesel 07-09 Delantero
742406	85215	124	48.0 mm 1-57/64"	Renault Sandero 10-12 Delantero
742407	85860	21994	54.0 mm 2-1/8"	Nissan Micra 05-07 Delantero
742408	851003	21003	65.9 mm 2-19/32"	Chevrolet Optra 06-10 Trasero
742409	850390	21058	54.0 mm 2-1/8"	Chrysler Durango 03-09 Ram 1500 01-10, Ram 2500 01-10 Caliper doble piston Delantero, Durango03-09, Ram 1500 01-10, Ram 2500 06-10 Trasero
742410	851060	2472	57.1 mm 2-1/4"	Ford Fusión 06-12 Delantero
742411	851002	21002	45.5 mm	Toyota Tacoma SR5, Tacoma TRD Sport 06-14 Delantero Caliper de 4 pistones
742412	850390	2473	54.0 mm 2-1/8"	Chrysler Dodge Durango 03-09 Caliper doble piston Delantero
742413	851047	21018	60.0 mm	Volkswagen Eurovan Diesel 06-10 Delantero
742414	851002	21028	45.5 mm	Toyota 4 Runner 03-09 Delantero
742415	851047	21047	60.0 mm	Chevrolet Vectra 03-07 delantero
742416	85209	643	54.0 mm 2-1/8"	Mitsubishi Lancer 04-09, Lancer Ralliart 05-06, Lancer DE ABS, Lancer ES 07-08, Suzuki Swift 07-09 Delantero
742417	851055	642	60.3 mm 2-3/8"	Mitsubishi Outlander 04-06, Mitsubishi Eclipse 06-09 Delantero
742418	851013	21013	54.0 mm 2-1/8"	Chevrolet Pontiac G5 Sedan, Sedan LS 07-09, Pontiac G5, Sedan GT, Pontiac Coupe GT 07-09, Pontiac G6 05-09 Delantero
742419	85393	2820	57.1 mm 2-1/4"	Ford Mondeo Core 01-07, Mondeo Trend 01-07, Mondeo Ghia 01-07 Delantero.
742420	851032	2029	57.1 mm 2-1/4"	Mazda 6i Grand Sport 06-10 Delantero
742421	851035	21035	50.8 mm 2"	Isuzu Elf 200 09-12 Del
742422	851028	21989	45.0mm	Chevrolet Captiva 08-14 Del
742423	85215	2215	48.0 mm 1-57/64"	Nissan Aprio 08-10, Platina 02-10, Renault Clio 02-10, Clio Expression 04-10, Clio Energy 07-09 Delantero
742424	85153	21998	66.0 mm	Chrysler Dodge Nitro 07-10, Journey 09-11, Wrangler 07-10 Town Country 08-10 Nacional, Caravan08-10 USA Delantero
742425	851030	21030	63.5 mm 2-1/2"	Toyota Camry LE 07-12, Camry XLE 07-12 Delantero
742426	851031	21031	60.3 mm 2-3/8"	Toyota Matrix 09-10 Delantero
742427	851034	21034	54.0 mm 2-1/8"	Chevrolet Pontiac G4 05-06 Delantero
742428	851036	21036	60.3 mm 2-3/8"	Suzuki Gran Vitara 06-12 Disco Disco Delantero
742434	851048	21048	52.0mm 2-3/64"	Nissan Cabstar 08-12, Renault Mascott 06-09, Volkswagen Crafter 5 Toneladas 08-12 CaliperBrembo doble piston cubreporlvo suave Delantero
742435	851053	21049	48.0 mm 1-57/64"	Mercedes Benz Sprinter 315 07-11, Sprinter 316 04-06, Sprinter 415 07-11, Nissan Cabstar 08-12, Volkswagen Crafter 3.5 Toneladas 08-12 Caliper Brembo de doble piston cubre polvo blando caliper Delantero
742436			48.0 mm 1-57/64"	Ford Transit 10-12 Delantero, Mercedes Benz Sprinter 315 07-09, Sprinter 316 04-06, Sprinter 41507-09, Srpinter 3500 07-09, Volkswagen Crafter 3.5 Ton 08-12 Caliper Bosch doble piston Cubre porlvo Duro Trasero
742438	851059	21059	60.0 mm	Ford F-350 Super Duty XT 12-13, F-350 Super Duty XTL 12-13 caliper doble piston cubrepolvo duroDelantero

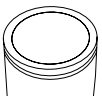



No. PARTE LUSAC	No. PARTE RAYBESTOS	LARGO	MEDIDA DE CUERDA DE CONECTORES		APLICACIÓN
0007	BH36564	18.69"	7/16 X 20	7/16 X 24	Chevrolet Tras C30,C35 70-72, C40 70-72, C50 70-88, C60 70-88.
1010	BH6560	18.06"	7/16 X 20	7/16 X 24	Ford Tras F-300, F-350 y F-400 53-66, F- 600 70-82
1017	BH33511	20"	3/8 X 24 Int5/8 X 18 Ext	7/16 X 20	Chrysler Del Dodge Camionetas D100-150 62-68; Del. y Tras. D100-150 61
1024	BH8116	20.25"	7/16 X 24 Int5/8 X 18 Ext	7/16 X 20	Chrysler Del Dodge D-300 70-71, D-600 70-77, Del. y Tras
1036	BH10595	11.5"	7/16 X 20	3/8 X 24	Chrysler Del Izq. Der. Dodge Dart Valiant 60
1067	BH24280	18.75"	3/8 X 24	7/16 X 24	VAM Tras Jeep, C-J5, 73-75
1091	BH36622	13.38"	3/8 X 24	3/8 X 24	Chrysler Del Dodge Coronet 71-74, Monaco 70-73, Super Bee 70-75, Ford Fairlane 62-66, Mustang65-66, Falcon 66
1095		N/D	N/D	N/D	Ford Del Izq Der F100-150 ECONOLINE 65-67; F300-350-400 65-72
1096		N/D	N/D	N/D	Ford Del Izq Der F-100 70-71, F-150 68-72
1100	BH16766	17.13"	3/8 X 24	3/8 X 245/8 X 18 Ext	Chrysler Del Dodge Camion Serie S-300, S-350 y S-400 69-71 USA
1118	BH381237	15.69"	3/8 X 24	3/8 X 24	Chrysler Del,Tras, Dodge Dart 63-64; Plymouth, Duster, Valiant 60-61, 64-65; Tras, Monaco 67-69.VAM Del, Rambler, American, y Vagoneta 70 y 74-76, Gremlin, 76-83 Rally, Amx 71 -75, Javelin 70
1122	BH36635	14.25"	3/8 X 24	3/8 X 24	Nissan Tras Datsun Sedan 60-68., VAM Javelin Tras. 71-73; Rambler Classic Del. y Tras. 60-69, C/Tambor Del. 71, Tras. 73-76; Rambler, Amer., Vagoneta, Gremlin, Lerma, Rally Amx Del y Tras. 60- 69, Tras. 1975; Tras Jeep CJ-5 70-72 Willis 4X4, Tras. 60-71
1126	BH36801	16"	3/8 X 24	3/8 X 24	VAM Del Jeep CJ-5 70-77 Willis CJ5D 74-77
1128	BH11146	17.88"	3/8 X 24	3/8 X 24	VAM Del y Tras Jeep Willis Vagoneta J162 y J164V, Wagoneer J100 4X4 64-70 y Tras Jeep WillisPick Up J265-264D 65-67 Del Jeep DJ-5 70-73
1129	BH36614	14.88"	3/8 X 24	3/8 X 24	Ford Tras F-100 70-79, VAM Del Jeep Willis, Vagoneta J162, J164, Wagoneer J100, 4X4, J164 1971- 73; Pick-Up J265,Redilas J364R.J300 J3M 64,65,71,73, Rambler Classic, Brougham Amx 63-66,VAM Tras Jeep Willis, Jeep C-J5 76-78 Del.Tras.
1137	BH36611	13.75"	7/16 X 20	3/8 X 24	Chevrolet Delantera Oldsmobile 88-89,Custom Crusier 63-64 Trasera, Chevelle Malibu 62-63,Chrysler Del Dodge Monaco 70, Super Bee 70, Valiant Duster 73-76. USA.
1138	BH13841	17.94"	7/16 X 20	3/8 X 24	Chevrolet Del y Tras Corvette 53-62
1139	BH36800	18.94"	7/16 X 20	3/8 X 24	Chevrolet Trasero Bel-Air 58-64. Del, Jeep Del Jeep Willis Vagoneta (J162, J164V), Wagonner J100,4X4, J164 1974
1144	BH36555	14.25"	7/16 X 20	3/8 X 24	Chrysler Del Dodge Monaco 67-69; Dart 65 y Tambor 10" 66-69. Plymouth 8 Cil 65 y Tambor 10" U11" 66-69
1145	BH36717	13.25"	7/16 X 20	3/8 X 24	Chrysler Del Dodge Plymouth-Barracuda (F. Disco) 70-71; Charger, Coronet (F. Disco) 1972; Monaco (F.Disco) 1969; Dart (F.Disco) 1972; Super Bee 70-72,B-100,150,200,250,71-72 USA. Tras.Impala 70
1159	BH2263	N/D	N/D	N/D	VAM Tras Rambler Classic 67-70
1163	BH36793	14.94"	7/16 X 20	3/8 X 24	VAM Del Classic 76 Amx 75-76, Pacer 76-79; Rambler, American, y Vagoneta, 77-83 Gremlin, 74-83Rally (Caliper Bendix) 73-76 Amx 75-81
1167	BH36669	19.06"	3/8 X 24 Int5/8 X 18 Ext	7/16 X 20	Chrysler Del Dodge Camioneta. D100-150 69-71
1175	BH36696	26.38"	7/16 X 24 Int5/8 X 18 Ext	7/16 X 20	Chevrolet Del Camion Serie 50 70-72
1177	BH36593	13.25"	3/8 X 24	3/8 X 24	Ford Del Mustang (F. Tambor) 70; Maverick 70
1178		25.12"	N/D	N/D	Ford Del B-600, F-600 70-85, F-350 70-71
1179	BH36699	15.37"	N/D	N/D	Ford Del Galaxie 73-74 , Maverick 74-75
1180	BH36854	13.75"	M12 X 1	7/16 X 24	Ford Del Fairmont y Fairmont Vagoneta 78-81
1181	BH38606	12.44"	7/16 X 24	M12 X 1	Ford Del Mustang 79-84; Fairmont y Fairmont Vagoneta 78-83 Grand Marquis 83- 84, Mustang 88-93
1182	BH36743	16.69"	7/16 X 24	3/8 X 24	Ford Del Mustang 74-78
1183	BH36853	14.13"	M12 X 1	3/8 X 24	Ford Del Crown Victoria 81, LTD 75-80
1186		N/D	N/D	N/D	Chevrolet Del Izq Der Opel 70-72
1197	BH36554	21.31"	7/16 X 20	7/16 X 24	Chevrolet Tras Blazer Nevada 91, C20,C25 79-87, Panel P30 82-92 y 97-98, Suburban 87.
1198	BH36542	22.31"	7/16 X 20	7/16 X 24	Chevrolet Tras Chevy Nova 75-76, C10 74-78, C15 82-87, C30,C35 74-87, Dina Tras D3000 y 3200(Der) 77-83.
1200	BH36525	12.5"	7/16 X 20	3/8 X 24	Chevrolet Del Chevy Nova 73-74

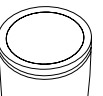



No. PARTE LUSAC	No. PARTE RAYBESTOS	LARGO	MEDIDA DE CUERDA DE CONECTORES		APLICACIÓN
1201	BH36555	14.25"	7/16 X 20	3/8 X 24	Chrysler Del Dodge Monaco 67-69; Dart 65 y Tambor 10" 66-69. Plymouth 8 Cil 65 y Tambor 10" U11" 66-69
1203	BH38117	10.5"	M10 X 1	M10 X 1	Nissan Manguera de Embrague Datsun-Pick Up, Vagoneta y Sakura 72-84
1204	BH38125	11.69"	M10 X 1	M10 X 1	Nissan Del Datsun Sedan y Vagoneta (Calipers Importados, Cuerdas Americana) 79-82, Tras.NissanSakura 83, Samurai 84-87
1205		11.72"	M10 X 1	M10 X 1	Nissan Tras Datsun Sedan 73-84; Vagoneta 79-84; Nissan Sakura 82 y 84
1206	BH36736	14.5"	M10 X 1	M10 X 1	Nissan Del Datsun Sedan 69-84 y Tras Datsun Sedan 70-73 (Excepto Calipers Importados);Vagoneta 69-76 (Excepto Cuerda Americana) Del. y Tras.Vagoneta 77-78, Del Sakura 82, Nissan Pick Up Estaquitas 72-78
1208	BH36888	17.25"	M10 X 1	M10 X 1	Nissan Tras Datsun Pick-Up 79-84
1211	BH36887	12.88"	M10 X 1	M10 X 1	Nissan Del Datsun Pick-Up 79-82, Tras.Nissan Estaquitas Pick Up 72-86 Cil.Rueda De 13/16"
1212	BH36736	14.5"	M10 X 1	M10 X 1	Nissan Del Datsun Sedan 69-84 y Tras Datsun Sedan 70-73 (Excepto Calipers Importados);Vagoneta 69-76 (Excepto Cuerda Americana) Del. y Tras.Vagoneta 77-78, Tras. Sakura 82, Nissan Pick Up Estaquitas 72-78
2016	BH36654	11.63"	3/8 X 24	3/8 X 24	Chrysler Del Dodge Dart 70-73, Valiant Duster 70-73, (F.Tambor)
2022	BH36582	11.88"	3/8 X 24	3/8 X 24	Chevrolet Delanteras Chevelle 70-72, Chevelle Malibu 70-72. Chrysler Delanteras Dodge Dart 71-76,Valiant Duster 71-76.
2024	BH38977	13.75"	M10 X 1	M10 X 1	Nissan Del Datsun Pick-Up 1978 y 1/2 Cuerda Americana. USA
2025	BH38069	8.15"	M10 X 1	M10 X 1	Chevrolet Tras Celebrity 82-89, Citation 82-86, Century 83-96, Cutlass 87-96, Cutlass Eurosport 87-96, Silhouette 91-95.
4001	BH36797	12"	Sin Rosca	3/8 X 24	Chevrolet Del Izq Der Caprice 77-78 Nacional, Ford Del Izq E-100 76-79 Impala 77-78 USA.
4004	BH36748	19"	Sin Rosca	3/8 X 24	Ford Del Der F-100 73-79
4009	BH36811	20"	Sin Rosca	3/8 X 24	Ford Del F-350 77-79, P-350 Microbus 77-78.
4010	BH36718	15.56"	Sin Rosca	3/8 X 24	Chrysler Del Dodge D-100 73-80, D-300 72-74.
4013		N/D	N/D	N/D	Chrysler Del Dodge D-150 81-93, D-250 86-93, D-300 79-80, D-350 Microbus 88-93, Ram Charger 86-96.
4014	BH36773	15.25"	Sin Rosca	3/8 X 24	Chevrolet Del Impala 71-75
4016	BH38160	16.19"	Sin Rosca	3/8 X 24	VAM Del Jeep CJ -5 78-86 Jeep Willis (4X4) CJ5D, (4X2) CJ5S, Renegado (Todos) CJ-7 1979-82
4017	BH36755	15.38"	Sin Rosca	3/8 X 24	Chrysler Del Der Dodge Dart 73-82, Super Bee 1973-76; Valiant Duster 73-76
4020	BH36831	17.63"	Sin Rosca	3/8 X 24	Chrysler Del Der Dodge Le Baron 78-80, Del Izq Der Valiant Volare 77-79.
4023	BH38055	15.25"	Sin Rosca	3/8 X 24	Chrysler Del Der Dodge Cordoba 80-82, Le Baron 81-82, Magnum 81-82, Valiant Volare 80-81.
4034	BH36984	19.88"	Sin Rosca	3/8 X 24	Ford Del Der F- 150 80-91, F-200 86,
4035	BH36983	19.75"	Sin Rosca	3/8 X 24	Ford Del Izq F- 150 80-91, F-200 86,
4036	BH36951	18.5"	Sin Rosca	3/8 X 24	Ford Del Izq Der F-200 86-91, F350 80-94. Del Der. F-250 92-94
4037	BH36935	12.23"	Sin Rosca	3/8 X 24	Ford Del Der Grand Marquis 82.
4038	BH36936	12.23"	Sin Rosca	3/8 X 24	Ford Del Izq Grand Marquis 82.
4040	BH36759	23"	Sin Rosca	3/8 X 24 Int5/8-18 Ext	Chevrolet C10 73-78, C30, C35 71-78, Del Izq Der Chevy Nova 77-78, Dina Del Der 1000 75-79; 3000y 3200 75- 83
4041	BH36760	23"	Sin Rosca	3/8 X 24 Int5/8-18 Ext	Chevrolet Del Izq C-10,15,20,25 76-86. C10 73-78, C30, C35 71-78, Dina Del Izq 1000 75-79; 3000 y3200 75-83
4042	BH38066	22.75"	Sin Rosca y 5/8 X 18 Ext	3/8 X 24 Int	Chevrolet Del Der C15 82-87, Dina Del Der; Dina 1000, 3000 y 3200 80- 83.
4043	BH38065	22.75"	Sin Rosca y 5/8 X 18 Ext	3/8 X 24 Int	Chevrolet Del Izq C15 82-87, Dina Del Izq 1000, 3000 y 3200 80-83.
4044	BH36646	15.31"	Sin Rosca	3/8 X 24	Chevrolet Del Impala 71-72
4048	BH36847	12.25"	Sin Rosca	3/8 X 24	Chevrolet Del Chevelle Malibu 79-81, Montecarlo 81-84
4049	BH36846	12"	Sin Rosca	3/8 X 24	Chevrolet Del Caprice 81-82
4050	BH38100	16"	Sin Rosca	M10 X 1	Chevrolet Del Der Celebrity 82, Citation 82, Century 83-86.
4051	BH38101	16.06"	Sin Rosca	M10 X 1	Chevrolet Del Izq Celebrity 82-89, Citation 82-86, Century 83-96 , Cutlass 87-96, Cutlass Eurosport 87-96.
4055	BH38209	22.25"	Sin Rosca	M10 X 1	Nissan Del Ninja Turbo 86-87, Sakura 85-86 Samurai 81-87
4056	BH38151	16.25"	Sin Rosca	3/8 X 24	VAM Del Der Willis CJ5D 4X4 CJ5S 4X2 83-85, Jeep CJ-7 82-84
4062	BH38194	16.5"	Sin Rosca	3/8 X 24	Ford Del Der Ghia 91-94, Topaz 84 -94.
4063	BH38193	16.63"	Sin Rosca	7/16 X 24	Ford Del Izq Ghia 91-94, Topaz 84- 94.



No. PARTE LUSAC	No. PARTE RAYBESTOS	LARGO	MEDIDA DE CUERDA DE CONECTORES		APLICACIÓN
4068	BH38178	17.63"	Sin Rosca	M10 X 1	Chevrolet Del Der Celebrity 83-89, Citation 83-86, Century 87-96 Cutlass 87-96, Eurosport 87-96, Silhouette 91 Nacional, Chevrolet Del Der Pontiac Trans Sport 90-91 USA.
4072	BH38045	21.25"	Sin Rosca	3/8 X 24	Chrysler Del Der Dodge Dart K 82-88, Dart K Guayin 82-88, Dart E- 89, Le Baron K 83-87, Magnum K 83-88, New Yorker 85-89, Phantom 87-89, Serie 600 K 84-85, Shadow 89, Shadow GTS 89, Spirit 90, Volare K 82-88.
4073	BH38046	21.25"	Sin Rosca	3/8 X 24	Chrysler Del Izq Dodge Dart K 82-88, Dart K Guayin 82-88, Dart E- 89, Le Baron K 83-87, Magnum K 83-88, New Yorker 85-89, Phantom 87-89, Serie 600 K 84-85, Shadow 89, Shadow GTS 89, Spirit 90, Volare K 82-88.
4222	BH38080	13"	Sin Rosca	M10 X 1	Chevrolet Del Izq Cavalier 90-91, Cavalier Z24 91.
4223	BH38074	12"	Sin Rosca	M10 X 1	Chevrolet Del Der Cavalier 90-91, Cavalier Z24 91.
5003	BH11592	N/D	N/D	N/D	Ford Tras F-350 70-79;
5004	BH36778	14.69"	3/8 X 24	3/8 X 24	VAM Tras Rambler Classic, 74-76 Rambler, American, Vagoneta, 74-83 Gremlin, 74-83 Lerma, RallyAmx 73-76; Pacer 76-79; Javelin 70
5005	BH38131	16.63"	3/8 X 24	3/8 X 24	VAM Tras American 70-73 y 77-83, Classic 74-76, Gremlin 77-83, Javelin 70, Pacer 76-78
5010	BH36648	14.5"	(2) 3/8 X 24	3/8 X 24	Chrysler Tras Dodge Dart 71-82, Le Baron 78-80, Super Bee 70-80, Valiant Duster 71-76, ValiantVolare 77-81,
5014	BH36833	13.13"	3/8 X 24 & 7/16 X 24	3/8 X 24	Ford Tras Mustang 74-78.
5016	BH38083	23.25"	(2) 3/8 X 24	3/8 X 24	Chrysler Tras Dodge D-300 72-74, D-350, Microbus 81-90.
5021	BH36949	14.88"	3/8 X 24 Int/7/16 X 24 Ext	3/8 X 24 Int/7/16 X 24 Ext	Ford Tras Grand Marquis 82. LTD 75-80, Crow Victoria 81, y Mang Central Tras para Grand Marquis 95-97
6006		N/D	N/D	N/D	Renault Delantera Izq. Der. R-12, R-12L, R-12TI 72-84;
6024	BH36779	11"	M10 X 1	M10 X 1	Volkswagen Tras Combi y Panel 88-01
6026	BH36874	14"	M10 X 1	M10 X 1	Volkswagen Del Brasilia 74-82
6027	BH36702	15.06"	M10 X 1	M10 X 1	Volkswagen Delantera (F-Tambor) Sedan 73-94 y Delantera (F. Disco) 95-04
6028		N/D	N/D	N/D	Volkswagen. Delantera Safari 71-77
6029		N/D	N/D	N/D	V.W. Delantera Sedan 64-72
6030	BH27298	18.94"	M10 X 1	M10 X 1	Volkswagen Del Sedan 63
6031	BH38028	13.25"	M10 X 1	M10 X 1	Volkswagen. Del Caribe 78-87, Atlantic 81-87, Jetta (A3) 93-96, Corsar 83-84, Golf A2 C, CL, GL 87- 92, Golf GTI A2 89-92, Jetta A2 88-92, Jetta A3 CL, GL, 93-99 Todos los Calipers Anteriores, Corsar 85-88, Corsar Variant 86-88 Del Izq. y Der.
6037		N/D	N/D	N/D	Renault Delantera R-5, Mirage 81-85
7006	BH36872	13.25"	M10 X 1	M10 X 1	Volkswagen Del Combi Panel 73-88
7010	BH36872	13.25"	M10 X 1	M10 X 1	Volkswagen Del Combi Panel 88-01
36531	BH36531	18.38"	3/8 X 24	3/8 X 24	Ford Del Izq Der F-100 70-71.
36620	BH36657	14.25"	Sin Rosca	3/8 X 24	Ford Del Izq Mustang 71-73.
36643	BH36643	14.88"	M10 X 1	M10 X 1	Ford Del Izq Der Mustang 71-72.
36649	BH36649	15.38"	7/16 X 24	7/16 X 24	Ford Del Izq Der Maverik 74-77.
36694	BH36694	13.63"	3/8 X 24	3/8 X 24	Chrysler Del Izq Der Dodge Monaco 71-72.
36712	BH36712	15.63"	Sin Rosca	3/8 X 24	Chevrolet Del Izq Chevy Nova 75-76.
36737	BH36737	15.5"	3/8 X 24	3/8 X 24	Nissan Del Izq Der Estaquitas Pick Up 70-72.
36765	BH36765	14.69"	(2) 3/8 X 24	7/16 X 24	Chevrolet Tras Microbus 88-91.
36786	BH36786	20.13"	Sin Rosca	3/8 X 24	Ford Del Izq F-350 73-75.
36787	BH36787	20.13"	Sin Rosca	3/8 X 24	Ford Del Der F-350 73-75.
36807	BH36807	16.81"	3/8 X 24	3/8 X 245/8 X 18 Ext	Ford Del Izq Der P-350 72-76.
36820	BH36820	20"	Sin Rosca	3/8 X 24	Ford Del Der F-350 76.
36824	BH36824	8.88"	M10 X 1	M10 X 1	Mitsubishi Montero 03-04, Tras Izq. y Der.
36828	BH36828	15"	Sin Rosca	3/8 X 24	Chrysler Del Izq Der Dodge Super Bee 80..
36850	BH36850	19.88"	3/8 X 24	3/8 X 24	Ford E-250 78-85 Tras USA
36855	BH36855	22.63"	Sin Rosca	3/8 X 24 Int/5/8-18 Ext	Chevrolet Del Der C-20, C-25 79-87.
36940	BH36940	12.13"	M10 X 1	M10 X 1	Nissan Del Izq - Der Sakura 84
36952	BH36952	23.13"	Sin Rosca	3/8 X 245/8 X 18 Ext	Chevrolet Del Izq C30, C35 79-89, Microbus 88-93 y 97-00.





No. PARTE LUSAC	No. PARTE RAYBESTOS	LARGO	MEDIDA DE CUERDA DE CONECTORES		APLICACIÓN
36954	BH36954	23.25"	Sin Rosca	3/8 X 245/8 X 18 Ext	Chevrolet Del Izq C30, C35 79-80, Panel P-30 82-92 y 97-98, Suburban 87, C60 83-88
36956	BH36956	22.25"	Sin Rosca	3/8 X 245/8 X 18 Ext	Chevrolet Blazer 79-86; GMC Jimmy 79-86 Del Izq USA
36957	BH36957	23.16"	Sin Rosca	3/8 X 245/8 X 18 Ext	Chevrolet Del Der C30, C35 79-89, Microbus 88-93 y 97-00.
36966	BH36966	14.16"	M10 X 1	M10 X 1	Toyota Pickup 79-95 Del Tras USA
36967	BH36967	18.5"	M10 X 1	M10 X 1	Toyota Pickup 79-85 Del USA
38002	BH38002	8.88"	M10 X 1	M10 X 1	Volvo C 70 99-01 Del. Izq y Der; S 70 99-00 Del Izq. Y Der; V 70 Vagoneta 99-04 Del Izq. Y Der.(Solo en versiones con disco en las cuatro ruedas)
38009	BH38009	22"	M10 X 1	M10 X 1	Nissan Estaquitas Pick Up 95-03 Tras Izq Der
38011	BH38011	10.25"	M10 X 1	M10 X 1	Nissan Sentra 1.6 Lts. 92. Tras.
38014	BH38014	11.16"	M10 X 1	M10 X 1	Nissan Tsuru III GS 93-14. Tsuru GSR 2000 93-96. Tras.
38016	BH38016	16.88"	M10 X 1	M10 X 1	Nissan Del Izq Truck 720 80-83 USA
38017	BH38017	17.5"	M10 X 1	M10 X 1	Nissan Del Der Truck 720 80-83 USA
38027	BH38027	8.88"	M10 X 1	M10 X 1	Audi cabriolet 97-98 Tras Izq
38044	BH38044	19.88"	3/8 X 24 Int7/16 X 24 Ext	3/8 X 24	Ford F-350 87-89. Tras.
38050	BH38050	12"	Sin Rosca	3/8 X 24	Chrysler Del Izq Dodge W-250 4X4 89-93.
38059	BH38059	20.75"	Sin Rosca	3/8 X 24	Chevrolet Del, Izq Blazer Nevada 91
38061	BH38061	19.5"	3/8 X 24 Int	Sin Rosca	Chevrolet Del, Der Blazer Nevada 91
38064	BH38064	8.25"	Sin Rosca	3/8 X 24	Chrysler Dart "K" y Guayin 82-88. Dart "E" 89, Magnum "K" 83-88, New Yorker 85-89, Phantom 87-89. Serie 600 "K" 84-85. Shadow 89, Shadow GTS Turbo 89, Volare "K" 82-88, Le baron "K" 83-87, Volare "k" 85-88
38068	BH38068	18.25"	(2) 3/8 X 24	7/16 X 24	Chevrolet G20, G25 73-95 Tras USA
38081	BH38081	7.5"	M10 X 1	M10 X 1	Chevrolet Tras. Izq Disco Cadillac Seville 96, Tras Izq Der Cavalier 90-04, Cavalier Z24 91-96, Sunfire 97-05.
38082	BH38082	25.38"	(2) 3/8 X 24	3/8 X 24	Chrysler Tras Der Dodge Ram Van y Ram Wagon 1500 95-97 Ram Van y Ram Wagon 2500 96-97 Nacional, Chrysler Tras Der Dodge B-100,150,200,250, 81-85, B-300,350 81-89 USA
38090	BH38090	13.25"	(2) 3/8 X 24	3/8 X 24	Chrysler Dodge W-100, W-150 79-85; Dodge W-200, W-250 78-93; Ramcharger 78-85 Del USA
38096	BH38096	18.94"	(2) M10 X 1	M10 X 1	Chevrolet Luv 97-05 Nacional, Isuzu Rodeo 91-97 Tras USA
38106	BH38106	17.88"	Sin Rosca	3/8 X 24	Ford Del Izq P-350 Microbus 89-91
38107	BH38107	12.56"	Sin Rosca	3/8 X 24 Int3/4 X 16 Ext	Chevrolet Del, Izqu Der, Blazer Pick Up S&T 10 82-90 USA
38108	BH38108	18.75"	Sin Rosca	3/8 X 24 Int3/4 X 16 Ext	Chevrolet Tras Blazer Pick Up S&T 10 82-90 USA
38109	BH38109	12.06"	M10 X 1	M10 X 1	Eagle Summit 92-96 Del Tras USA
38121	BH38121	21.25"	Sin Rosca	3/8 X 24	Ford F-200 F-250 80-96; Ford F-300 F-350 80-94 Del USA
38129	BH38129	18.75"	(2) 3/8 X 24	3/8 X 24	VAM Tras Izq Der Jeep CJ-5 84-86 Jeep CJ-7 82-84
38138	BH38138	20.44"	Sin Rosca	3/8 X 24 Int3/4 X 16 Ext	Oldsmobile Bravada 91 Del Izq USA
38139	BH38139	20.56"	Sin Rosca	3/8 X 24 Int3/4 X 16 Ext	Oldsmobile Bravada 91 Del Der USA
38146	BH38146	21.25"	(2) 3/8 X 24	3/8 X 24	Ford Bronco 83-88; Ford Ranger 83-88 Tras USA
38147	BH38147	19.75"	Sin Rosca	3/8 X 24	Ford Del Izq Der Ranger 83-88 USA
38150	BH38150	16.44"	Sin Rosca	3/8 X 24	VAM Del Izq Jeep CJ 7 82-84 la Der es la 4056
38157	BH38157	20"	(2) 3/8 X 24	3/8 X 24	Jeep J10, J20 81-90 Tras USA
38158	BH38158	15.38"	Sin Rosca	3/8 X 24	VAM Del Izq-Der Jeep Wagoneer 81-86.
38159	BH38159	14.38"	Sin Rosca	3/8 X 24	Chrysler Del, Izq, Der, Wagoneer 77-80, Cherokee 81-83, Gran Wagoneer 87-93. USA
38164	BH38164	11.5"	M10 X 1 (LH)	M10 X 1	Volkswagen. Del Izq-Der Atlantic 81-87. Caribe 77-79. Caribe GT 83-86. Corsar 83-84. Caliper Girling (Rosca Izq.)
38167	BH38167	23.88"	Sin Rosca	3/8 X 24	Chevrolet P-30 79-83 Del Der USA
38168	BH38168	7.38"	M10 X 1	M10 X 1	Volkswagen. Tras Izq- Der Golf GTI A2 (F.Disco) 89-92, Tras Der Golf GTI A3 93-98, Tras Der Golf A3 GTI VR6 96-98 Tras Der Jetta GLS y Europa A3 (F.Disco) 93-98, Tras Der Jetta VR6 A3 (F.Disco) 96-98, Tras Der Passat (F.Disco) 91-93, y Tras Der Passat VR6 (F.Disco) 96-97.

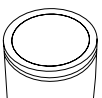



Buyers Guides



No. PARTE LUSAC	No. PARTE RAYBESTOS	LARGO	MEDIDA DE CUERDA DE CONECTORES		APLICACIÓN
38180	BH38180	12.13"	(2) M10 X 1	M12 X 1	Chevrolet Camaro 84-92; Firebird, Trans Am 84-92 Tras Disco Tambor USA
38181	BH38181	19.31"	Sin Rosca	M10 X 1	Chevrolet Camaro 84-92; Firebird, Trans Am 84-92 Del Izq USA
38182	BH38182	23.94"	Sin Rosca	3/8 X 24	Chevrolet Del Izquierda G20 95.
38183	BH38183	23.19"	Sin Rosca	3/8 X 24	Chevrolet Del Der G20, 95
38184	BH38184	25.25"	Sin Rosca	3/8 X 24	Chevrolet G-30, G-35 83-95 Del Izq USA
38185	BH38185	24.13"	Sin Rosca	3/8 X 24	Chevrolet G-30, G-35 83-95 Del Der USA
38186	BH38186	21.25"	Sin Rosca	3/8 X 24	Chevrolet Del Izq C20, C25 79-87
38197	BH38197	23"	(2) 3/8 X 24	3/8 X 24	Chrysler Dodge Ram Van1500 Ram Wagon 1500 95-97, Ram Van 2500 Ram Wagon 2500 96-97,Tras Izq
38199	BH38199	23.25"	Sin Rosca	3/8 X 24	Chrysler Del, Izq Dodge D-350 Microbus 81-87
38200	BH38200	23"	Sin Rosca	3/8 X 24	Chrysler Del Der Dodge D-350 Microbus 81-87, Ram Van y Ram Wagon 1500 95-97, Ram Van y Ram Wagon 2500 96-97, Ram Van y Ram Wagon 3500 96-97
38218	BH38218	10.81"	M10 X 1	M10 X 1	Honda Civic 97-01 Tras Izq Der
38237	BH38237	20"	Sin Rosca	3/8 X 24	Ford Del Der E150 84-85. USA
38239	BH38239	19.88"	Sin Rosca	3/8 X 24	Ford Bronco 84-85 Del Der USA
38243	BH38243	26.13"	(2) 3/8 X 24	3/8 X 24	Chrysler Tras Dodge D-150 81-90; D-250 86-87; Ram Charger 86-96; W-150 85-87; W-250 4X4 86-93
38244	BH38244	12.44"	(2) 3/8 X 24	3/8 X 24	Chrysler Del Izq-Der Dodge W- 250 4 X 4 86-88.
38245	BH38245	16"	3/8 X 24	3/8 X 24	Chrysler Tras Dodge Caravan 84-88; Mini Van Ram 84-88; Voyager 84-88 (USA)
38252	BH38252	19.13"	Sin Rosca	M10 X 1	Chevrolet Camaro 84-92; Firebird, Trans Am 84-92 Del Der USA
38253	BH38253	18.25"	Sin Rosca	M10 X 1	Chevrolet Del Izq Cadillac Deville 91-93, Cadillac Deville/Concours 94-96, Oldsmobile88 92
38258	BH38258	15.5"	M10 X 1	M10 X 1	Renault Alliance 84-86, Encore 85-86 Del Izq Der
380260	BH380260	15.5"	Sin Rosca	M10 X 1	Chevrolet Del Der Corvette 94-96
38261	BH38261	14.88"	(2) 3/8 X 24	7/16 X 24	Chevrolet Astro Mini Van 85-02; Safari Mini Van 85-02 Tras USA
38262	BH38262	18.31"	Sin Rosca	M10 X 1	Chevrolet Del Der Cadillac Deville 91-93, Cadillac Deville/Concours 94-96, Oldsmobile88 92
38267	BH38267	11.38"	Sin Rosca	3/8 X 24	Chevrolet C-30 90, C-35, C-3500 90 y 01-02, C-3500 HD 01-02 Del. Der.
38268	BH38268	24.25"	Sin Rosca	3/8 X 24	Chevrolet G-30, G-35 83-95 Del Izq USA
38275	BH38275	12.38"	M10 X 1	M10 X 1	Eagle Talon 90-94; Del Tras USA, Mitsubishi Eclipse 90-94 Del Tras USA
38276	BH38276	16.25"	Sin Rosca	7/16 X 24	Ford Mustang 84-86; Thunderbird 87-88 Del Der USA
38300	BH38300	13.88"	M10 X 1	M10 X 1	Volkswagen Del Izq -Der Jetta A2 87.
38328	BH38328	10.5"	M10 X 1	M10 X 1	Mitsubishi Eclipse 03-05, Galant 03, Dodge Stratus 98-05 Tras Izq Der
38332	BH38332	19.25"	Sin Rosca	3/8 X 24 Int7/16 X 24 Ext	Ford F-200 86 Tras
38334	BH38334	20.5"	Sin Rosca	(2) 3/8 X 24	Ford E-250 85-88; E-350 85-87 Tras USA
38337	BH38337	24.06"	Sin Rosca	3/8 X 24	Ford Bronco 86; Ford Ranger 86 Del Der USA
38339	BH38339	19.63"	Sin Rosca	3/8 X 24	Ford F-200 86 Tras
38340	BH38340	21.88"	Sin Rosca	3/8 X 24	Ford Ranger 86 Del Der USA
38341	BH38341	21.88"	Sin Rosca	3/8 X 24	Ford Ranger 86 Del Izq USA
38342	BH38342	17"	Sin Rosca	3/8 X 24	Ford Del Izq Aerostar 86-87 USA
38343	BH38343	16.75"	Sin Rosca	3/8 X 24	Ford Del, Der Aerostar 86-87 USA
38352	BH38352	18"	Sin Rosca	3/8 X 24	Jeep Cherokee 86-90; Jeep Comanche 86-90; Jeep Wagoneer 86-90 Del Der USA
38363	BH38363	16.69"	Sin Rosca	M10 X 1	Nissan Maxima 85-88 Del Izq USA
38365	BH38365	22.88"	Sin Rosca	3/8 X 24	Chevrolet P-30 85-93 Del Izq USA
38370	BH38370	9.44"	Sin Rosca	3/8 X 24	Ford Mustang 84-86 Tras Der USA
38371	BH38371	24.19"	Sin Rosca	3/8 X 24	Ford Bronco 86; Ford Ranger 86 Del Izq USA
38372	BH38372	9.63"	3/8 X 24	(2) 3/8 X 24	Ford Manguera Interna Mustang GT 94-95
38378	BH38378	10.75"	3/8 X 24	3/8 X 24	Ford Tras Izq-Der Ghia 91-94. Topaz 84-94
38379	BH38379	17.38"	Sin Rosca	3/8 X 24	Jeep Cherokee 84-85; Jeep Wagoneer 84-85 Del Izq USA
380381	BH380381	12.75"	Sin Rosca	M10 X 1	Ford Tras Izq Lincoln Town Car 95-96
38382	BH38382	16.69"	Sin Rosca	7/16 X 24	Ford Del, Izq Sable 94-95, Sable Vagoneta 94-97, Taurus 88-91
38384	BH38384	16.5"	Sin Rosca	7/16 X 24	Ford Del Der Thunderbird Turbo 87-88 Cougar 87-88, la Izq es la 38383
38387	BH38387	13.69"	(2) 1/2 X 20	7/16 X 24	Ford Lincoln Mark VIII 94-96 Tras Der





No. PARTE LUSAC	No. PARTE RAYBESTOS	LARGO	MEDIDA DE CUERDA DE CONECTORES		APLICACIÓN
38389	BH38389	26.25"	Sin Rosca	M10 X 1	Honda Accord 86-89 Del Der USA
38418	BH38418	8.75"	M10 X 1	M10 X 1	Mitsubishi Truck 87-93 Del USA
38420	BH38420	12.88"	M10 X 1	M10 X 1	Mitsubishi Truck 87-89 Del USA
38421	BH38421	10.19"	Sin Rosca	3/8 X 24	Chrysler Del Izq- Der Dodge W-150 85-87, W-250 86-88.
38423	BH38423	10.13"	M10 X 1	M10 X 1	Mitsubishi Truck 83-86 Del Izq USA
38424	BH38424	21.5"	Sin Rosca	3/8 X 24	Chrysler Dodge Dakota 87 Del Der USA
38425	BH38425	21.5"	Sin Rosca	3/8 X 24	Chrysler Dodge Dakota 87 Del Izq USA
38426	BH38426	13.44"	3/8 X 24	3/8 X 24	Jeep Cherokee 84-89; Jeep Wagoneer 84-89 Tras USA
38441	BH38441	14.13"	M10 X 1	M10 X 1	Mitsubishi Truck 84-95 Tras USA
38466	BH38466	10.38"	Sin Rosca	M10 X 1	Eagle Summit 92-96; Eagle Talon 90; Tras USA, Mitsubishi Eclipse 91-93 Tras USA
38481	BH38481	20.94"	(2) M10 X 1	M10 X 1	Nissan Pick Up D-21 92-98, Pick Up 250 94-96 Tras Izq Der
38482	BH38482	17.5"	M10 X 1	M10 X 1	Nissan D21 86-93 Tras USA
380498	BH380498	24.25"	7/16 X 24	7/16 X 24	Chevrolet GMC 50 Series 93-94, GMC 60 Series 93-95, GMC 70 Series 93-95 Tras Der
38490	BH38490	10"	(2) 3/8 X 24	Sin Rosca	Ford Mustang 85-86 Del Tras USA
38491	BH38491	15.75"	Sin Rosca	M10 X 1	Nissan Del Izq. Pick Up D-21 92-03, Pick Up Estaquitas 72-03, Pick Up Doble Cabina 82-00, Pick Up250 94-96 Sentra 92
38494	BH38494	15.75"	Sin Rosca	M10 X 1	Nissan Del Der. Pick Up D-21 92-03, Pick Up Estaquitas 72-03, Pick Up Doble Cabina 82-00, Pick Up250 94-96
38496	BH38496	20.63"	Sin Rosca	M10 X 1	Nissan Del Izq-Der Tsuru I 84-87 Tsuru II 88-92, Tsuru III GS 93-14 Nacional, Nissan Del Izq-DerPulsar 87-90, Sentra 86-90 USA
38497	BH38497	17.13"	Sin Rosca	M10 X 1	Nissan Maxima 85-88 Del Der USA
38499	BH38499	19.69"	Sin Rosca	M10 X 1	Jeep Wrangler 87-89 Del Der USA
38501	BH38501	18.06"	Sin Rosca	3/8 X 24	Jeep Cherokee 86-90; Jeep Comanche 86-90; Jeep Wagoneer 86-90 Del Izq USA
38506	BH38506	10.38"	Sin Rosca	7/16 X 24	Ford Cougar 87-88; Thunderbird 87-88 Tras Izq
38514	BH38514	11.94"	M10 X 1	M10 X 1	Mercedes Benz C220 95, C280 98-00, C280 Vagoneta 98-99, C43 98-00, S500i 93, S80 99-06, VolvoXC70 04-07 Tras
38526	BH38526	16.13"	Sin Rosca	3/8 X 24	Nissan D21 86 Del Izq USA
38552	BH38552	12.75"	M10 X 1	M10 X 1	BMW Serie 5 525i 06-07, 530i 04-07, 535i 10-12, 550i 06-10, Serie 6 645ci 05, 650ci 06-09, 650i 08-12, Serie 7 745i 02-05, Serie 7 745Li 03-05, 750i 06-08, 750Li 06-08, Serie 7 760iL 03-04, 760Li 05-08, Serie M M5 06-11, M6 06-11 Tras Izq Der
38554	BH38554	16.88"	Sin Rosca	M10 X 1	Nissan D21 86-97 Del Izq USA
38557	BH38557	20.63"	Sin Rosca	3/8 X 24	Ford Bronco 87-88; Ranger 87-91 Del Der USA
38563	BH38563	24.25"	Sin Rosca	3/8 X 24	Chevrolet Del Der P-30 82-92 y 97-98 C60 83-88.
38571	BH38571	14.06"	Sin Rosca	M10 X 1	Nissan Del Izq Der Camioneta 720 83-84, USA
38572	BH38572	23.63"	Sin Rosca	3/8 X 24	Chevrolet Del Izq Suburban 90-98, Microbus 92-98 USA
38573	BH38573	23.63"	Sin Rosca	3/8 X 24	Chevrolet Del Der C30, C35 74-78
38576	BH38576	21.88"	(2) 3/8 X 24	3/8 X 24	Chrysler Dodge Ram Charger 86-96 y 99, Ram 1500 98-99, Ram 2500 98-99 Ram Van Ram Wagon3500 00-01 Tras
38579	BH38579	15.13"	Sin Rosca	3/8 X 24	Ford Aerostar 87-89 Del Izq USA
38580	BH38580	15.13"	Sin Rosca	3/8 X 24	Ford Aerostar 87-89 Del Der USA
38586	BH38586	21.25"	Sin Rosca	M10 X 1	Chevrolet Lumina 90 Tras Izq USA
38587	BH38587	18.11"	Sin Rosca	3/8 X 24	Chevrolet Del, Der Buick Regal 94-96
38588	BH38588	17.88"	Sin Rosca	M10 X 1	Chevrolet Del, Izq Buick Regal 94-96
38592	BH38592	23.5"	Sin Rosca	M10 X 1	Chrysler Dodge Dakota 87-90 Del Izq USA
38593	BH38593	23.5"	Sin Rosca	3/8 X 24	Chrysler Dodge Dakota 87-90 Del Der USA
38602	BH38602	21.38"	Sin Rosca	M10 X 1	Chevrolet Camaro 88-92 Del Der USA
38603	BH38603	21.38"	Sin Rosca	M10 X 1	Chevrolet Camaro 88-92 Del Izq USA
38604	BH38604	6.88"	Sin Rosca	3/8 X 24	Chrysler Tras Izq Der Imperial 91, Le Baron 92-95, New Yorker 90-94, Phantom 90-94, Shadow GTS89. Spirit R/T 91-95
38605	BH38605	17.25"	3/8 X 24	3/8 X 24	Chrysler Dodge Caravan 87-91; Mini Ram Van 87; Plymouth Voyager 87-91 Tras USA
38607	BH38607	19.56"	Sin Rosca	3/8 X 24	Ford Tras Izq Sable 94-95; Sable Vagoneta 94-95 (F. Disco)
38608	BH38608	19.44"	Sin Rosca	3/8 X 24	Ford Tras Der Sable 94-95; Sable Vagoneta 94-95 (F. Disco)
38609	BH38609	19.75"	7/16 X 20	1/2 X 20	Ford Tras Der Cougar 90-92; Thunderbird 90-92.

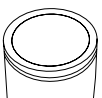



Buyers Guides



No. PARTE LUSAC	No. PARTE RAYBESTOS	LARGO	MEDIDA DE CUERDA DE CONECTORES		APLICACIÓN
38610	BH38610	19.75"	M10 X 1	7/16 X 24	Ford Tras Izq Cougar 90-92, Thunderbird 90-92
38612	BH38612	6.75"	Sin Rosca	M10 X 1	Chevrolet Beretta 92-93; Del Camaro 89-92 Tras Der USA
38614	BH38614	12.88"	Sin Rosca	M10 X 1	Chevrolet Del Izq Corvette 91-92.
38616	BH38616	21.5"	Sin Rosca	M10 X 1	Chevrolet Del Der Geo Tracker con ABS 93-95 y 98-99
38617	BH38617	30.13"	Sin Rosca	M10 X 1	Chevrolet Del Izq Geo Tracker con ABS 93-95 y 98-99
38618	BH38618	11.94"	M10 X 1	M10 X 1	Chevrolet Geo Tracker 93-95 y 98-99, Suzuki Gran Vitara 06-08 Tras Izq Der
38619	BH38619	8.5"	Sin Rosca	M10 X 1	Chevrolet Geo Tracker 93-95 Mang. Central
38620	BH38620	25.13"	Sin Rosca	3/8 X 24	Chevrolet Del, Izq C15 88-91 y 94-99, C20, C25 88-91, C20, C25 y Cheyenne 92-01, Maxicab 91-93, Silverado 95-99, Suburban 88-01.
38621	BH38621	25.13"	Sin Rosca	3/8 X 24	Chevrolet Del, Der C15 88-91 y 94-99, C20, C25 88-91, C20, C25 y Cheyenne 92-01, Maxicab 91-93, Silverado 95-99, Suburban 98-01.
38622	BH38622	25.75"	Sin Rosca	3/8 X 24	Chevrolet K20 Suburban 89-95; K20, K25 Picku 88-95 Del Izq USA
38623	BH38623	25.75"	Sin Rosca	3/8 X 24	Chevrolet K20 Suburban 89-95; K20, K25 Picku 88-95 Del Der USA
38624	BH38624	17.75"	3/8 X 24 Int/16 X 24 Ext	3/8 X 24	Chevrolet Tras Blazer Nevada 92-94, C15 88-91 y 94-99, C20, C25 88-99, C20, C25 y Cheyenne 92-01, C30, C35 88-90, C35, C3500, C3500 Heavy Duty 96-00, Express 1500, Express Cargo Van 150098-02, Express 2500, Express Cargo Van 2500 99-01, Express 3500, Express Cargo Van 3500 97-03, G15 98-02, G30 97-02, Maxicab 91-93, Silverado 95-00, Suburban 88-02, Panel P-30 01-03.
38626	BH38626	19.25"	Sin Rosca	(2) 3/8 X 24	Ford Del Izq Ranger 89-94 USA
38627	BH38627	19.25"	Sin Rosca	3/8 X 24	Ford Del Der Ranger 89-94 USA
38630	BH38630	21.5"	Sin Rosca	3/8 X 24	Ford E-250 88-89; E-350 88-89 Tras USA
38631	BH38631	20.13"	3/8 X 24	3/8 X 24	Ford F-350 84-92 Tras
38633	BH38633	11.75"	3/8 X 24	3/8 X 24	Chrysler Dodge D-200, D-250 89; D-300, D-350 89 Del USA
38636	BH38636	22.13"	(2) 3/8 X 24	3/8 X 24	Chrysler Tras Dakota 96; Ram Runner V-10 96-97, Ram 1500 94-97; Ram 2500 94-97; Ram 3500 94-99, Ram Van 3500 95-99, Ram Wagon 3500 95-99, Ram 4000 98-99. Ram SRT-10 05-06 Nacional, Chrysler Tras Dakota 89-96 USA
38637	BH38637	16.38"	Sin Rosca	M10 X 1	Chevrolet Del Izq Oldsmobile Silhouette 91 la Der es la 4068 Nacional, Chevrolet Del Izq Pontiac Trans Sport 90-91 USA. la Der es la 4068
38644	BH38644	21.5"	Sin Rosca	3/8 X 24	Chrysler Del Izq Imperial 90. USA
38646	BH38646	9.38"	3/8 X 24	3/8 X 24	Chrysler Tras Izq-Der Shadow 90-94, Spirit 90-95, Voyager 94-95, Town & Country 94-95.
38656	BH38656	11.88"	Sin Rosca	M10 X 1	Chevrolet Corvette 91-92 Tras Der
38657	BH38657	13.75"	Sin Rosca	3/8 X 24	Chevrolet Chevy C2, 2 puertas 04-13, Chevy C2 Sedan 4 puertas 05-07, Chevy Joy, Swing 94-03, Monza 97-03, Chevy Pop 96-03, Chevy Pick Up 99-03, Chevy Vagoneta 00-03, Saab 9-3 01-05 Del Izq Der
38658	BH38658	9.5"	Sin Rosca	3/8 X 24	Chevrolet Chevy C2, 2 puertas 04-13, Chevy C2 Sedan 4 puertas 05-07, Chevy Joy, Swing 94-03, Monza 97-03, Chevy Pop 96-03, Chevy Pick Up 99-03, Chevy Vagoneta 00-03, Cadillac Catera 97-01. Tras. Izq. Der.
38662	BH38662	22.25"	Sin Rosca	3/8 X 24	Chevrolet Del Izq C-30, C-35 88-89
38663	BH38663	22.25"	Sin Rosca	3/8 X 24	Chevrolet Del Der C-30, C-35 88-89
38664	BH38664	19.5"	Sin Rosca	3/8 X 24	Chevrolet Blazer Nevada 92-94. Del. Izq.
38666	BH38666	12.75"	7/16 X 24	7/16 X 24	Ford Tras Izq Sable Vagoneta 94-95; Taurus 88-91,
38665	BH38665	19.5"	Sin Rosca	3/8 X 24	Chevrolet Del Der Blazer Nevada 92-94
38668	BH38668	20"	7/16 X 24	Sin Rosca	Ford Del Der Cougar 90-92; Thunderbird 90-92. la Izq es la 38997
38669	BH38669	11.5"	3/8 X 24	3/8 X 24	Ford Tras Der Sable Vagoneta 94-95; Taurus 88-91.
38672	BH38672	14.5"	M10 X 1	M10 X 1	Geo Metro 89-01 Tras USA
38673	BH38673	19.5"	Sin Rosca	M10 X 1	Geo Metro 89-94 Del USA
38679	BH38679	18"	Sin Rosca	M10 X 1	Chevrolet Luv 97-00 Nacional, Isuzu Pickup 88-95; Rodeo 91-95 Del Izq Der USA
38681	BH38681	15.75"	Sin Rosca	3/8 X 24	Ford Del Der Sable 94-95 ; Sable Vagoneta 94-97 ; Taurus 88-91, la Izq es la 38382
38683	BH38683	12.25"	M10 X 1	M10 X 1	Nissan Maxima 92-93 Tras. Izq. Der. Sin ABS
38688	BH38688	23.38"	M10 X 1	M10 X 1	Nissan Del Izq Der 300 Zx 91-96, Convertible 93-95
38689	BH38689	19.63"	Sin Rosca	M10 X 1	Nissan Maxima 92-93 Tras. Izq. Der. Con ABS
38697	BH38697	21.75"	Sin Rosca	M10 X 1	Nissan Del Der 240Sx ABS 93.
38701	BH38701	21.5"	Sin Rosca	M10 X 1	Nissan Del Izq Der Maxima 91-93.
38709	BH38709	27.5"	Sin Rosca	M10 X 1	Honda Accord 88-89 Del Der USA

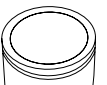



No. PARTE LUSAC	No. PARTE RAYBESTOS	LARGO	MEDIDA DE CUERDA DE CONECTORES		APLICACIÓN
38710	BH38710	26.19"	Sin Rosca	M10 X 1	Honda Civic 88 Del Der USA
38712	BH38712	27.5"	Sin Rosca	M10 X 1	Honda Accord 88-89 Del Izq USA
38714	BH38714	26.25"	Sin Rosca	M10 X 1	Honda Civic 88 Del Izq USA
38742	BH38742	22.81"	(2) 3/8 X 24	3/8 X 24	Chrysler Dodge B-100, B-150 90-97; B-200, B-250 90-97 Tras USA
38743	BH38743	19.88"	Sin Rosca	3/8 X 24	Chrysler Dodge B-100, B-150 90-93; B-200, B-250 90-93 Del Izq USA
38744	BH38744	26.25"	3/8 X 24	3/8 X 24	Chrysler Tras Dodge D-150 90-93, D-250 86-93, D-350 Microbus 90-93.
38745	BH38745	25"	(2) 3/8 X 24	3/8 X 24	Chrysler Dodge D-250 86-87, Ram 3500 95-97, Ram 4000 95-97 Tras
38746	BH38746	21.25"	Sin Rosca	M10 X 1	Chevrolet Del Der Cadillac Deville 91-93. Heavy Duty USA.
38747	BH38747	21.25"	Sin Rosca	M10 X 1	Chevrolet Del Izq Cadillac Deville 91-93. Heavy Duty USA.
38796	BH38796	17.19"	M10 X 1	M10 X 1	Toyota Pickup 89-93 Tras USA
38801	BH38801	10.81"	M10 X 1	M10 X 1	Mitsubishi Truck 83-85 Del/Izq USA
38804	BH38804	8.13"	M10 X 1	M10 X 1	Eagle 2000 GTX 89-92 Del USA
38808	BH38808	22.5"	Sin Rosca	3/8 X 24	Chevrolet Del Der C30,C35 92-95, C35, C3500, C3500 Heavy Duty 96-00, Microbus 94-00. Panel P-30 98-03,
38813	BH38813	19.9"	(2) 3/8 X 24	3/8 X 24	Ford Tras Explorer XLS V6, XLT V8, Limited 91-94; Ranger 96-09
38814	BH38814	14.19"	Sin Rosca	3/8 X 24	Ford Del Izq Aerostar 91-95
38815	BH38815	14.19"	Sin Rosca	3/8 X 24	Ford Del Der Aeroestar 91-95
38818	BH38818	17.5"	Sin Rosca	7/16 X 24	Ford Mustang 87-93 Del Der USA
38819	BH38819	17.5"	Sin Rosca	7/16 X 24	Ford Mustang 87-93 Del Izq USA
38823	BH38823	22.38"	7/16 X 24 Int5/8 X 18 Ext	3/8 X 24	Chevrolet Tras C30, C35 90-95, Microbus 92-00.
38824	BH38824	23.25"	Sin Rosca	3/8 X 24	Chevrolet Del Izq C30,C35 92-95, C35, C3500, C3500 Heavy Duty 96-00, Microbus 94-00. Panel P-3098-03
38831	BH38831	27.88"	Sin Rosca	M10 X 1	Honda Del Der Accord L4 96-97
38832	BH38832	27.88"	Sin Rosca	M10 X 1	Honda Del Izq Accord L4 96-97
38840	BH38840	11"	M10 X 1	M10 X 1	Ford Tras Izq-Der Escort LX 94-01, Escort Vagoneta 94-99; (F. Tambor)
38842	BH38842	16.13"	M10 X 1 Int	Sin Rosca	Ford Tras Izq-Der (F. Disco) Escort, LX 94-01; Escort Vagoneta 97-99, Escort GT 94-95
38845	BH38845	17.31"	(2) 3/8 X 24	3/8 X 24	Jeep Wrangler 93-96 Tras
38847	BH38847	14.38"	3/8 X 24	3/8 X 24	Jeep Cherokee 90-91; Jeep Wagoneer 90 Tras USA
38851	BH38851	19.63"	Sin Rosca	3/8 X 24	Chevrolet Astro Mini Van 90-99; Safari Mini Van 90-99 Del Izq USA
38852	BH38852	19.63"	Sin Rosca	3/8 X 24	Chevrolet Astro Mini Van 90-99; Safari Mini Van 90-99 Del Der USA
38855	BH38855	26.25"	Sin Rosca	M10 X 1	Honda Accord 86-89 Del Izq USA
38857	BH38857	27"	Sin Rosca	M10 X 1	Honda Civic 89-91 Del Izq USA
38861	BH38861	20.75"	Sin Rosca	3/8 X 24	Jeep Wrangler 93-96 Del Der
38862	BH38862	20.75"	Sin Rosca	3/8 X 24	Jeep Wrangler 93-96 Del Izq
38863	BH38863	18.13"	Sin Rosca	3/8 X 24	Chrysler Del Der Jeep Cherokee 91-93. Jeep Comanche 91-92 (USA)
38864	BH38864	18.13"	Sin Rosca	3/8 X 24	Chrysler Del Izq. Jeep Cherokee 91-93. Jeep Comanche 91-92 (USA)
38865	BH38865	20.13"	Sin Rosca	M10 X 1	Nissan Sentra 1.6 Lts 92 Del Der
38866	BH38866	18.75"	Sin Rosca	M10 X 1	Nissan Sentra 92 Tras
38867	BH38867	21.50"	N/D	N/D	Ford Tras F-150 88-91 USA
38869	BH38869	21.88"	Sin Rosca	M12 X 1	Chevrolet Delantera Izquierda Blazer 4X4 95-97, S-10 Pick Up 4X4 95-97
38870	BH38870	21.88"	3/8 X 24 Int	Sin Rosca	Chevrolet Delantera Derecha Blazer 4X4 95-97, S-10 Pick Up 4X4 95-97
38871	BH38871	18.88"	(2) 3/8 X 24	7/16 X 24	Chevrolet Tras, Izq-Der Blazer 95-01 Tambor, y Tras Izq-Der 98-99 Disco, S-10 Pick Up 95-04.
38872	BH38872	25.88"	3/8 X 24	3/8 X 24	Chevrolet Del Der C30,C35 91-95, C35, C3500, C3500 Heavy Duty 96-00, Microbus 97-00.
38873	BH38873	25.88"	Sin Rosca	3/8 X 24	Chevrolet Del Izq C30,C35 91-95, C35, C3500, C3500 Heavy Duty 96-00, Microbus 97-00.
38884	BH38884	17.63"	Sin Rosca	M10 X 1	Chevrolet Saturn 91-02 Del Der USA
38890	BH38890	17.38"	Sin Rosca	3/8 X 24	Chrysler Dodge Dakota 91 Del Der USA
38891	BH38891	19.75"	Sin Rosca	3/8 X 24	Chrysler Dodge Dakota 91 Del Izq USA
38892	BH38892	29.5"	Sin Rosca	3/8 X 24	Chrysler Dodge Trk. Dakota 91-96 Del Der USA
38893	BH38893	29.5"	Sin Rosca	3/8 X 24	Chrysler Dodge Dakota 91-96 Del Izq USA
38894	BH38894	18.37"	Sin Rosca	3/8 X 24	Jeep Del Der Jeep Cherokee Sport 94 y 98-01, Jeep Grand Cherokee 93-98, Jeep Wrangler, Jeep Wrangler Sahara 97-02, Jeep Wrangler Unlimited, Jeep Wrangler Rubicon 03-06

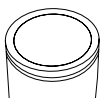



Buyers Guides



No. PARTE LUSAC	No. PARTE RAYBESTOS	LARGO	MEDIDA DE CUERDA DE CONECTORES		APLICACIÓN
38895	BH38895	18.37"	3/8 X 24	3/8 X 24	Jeep Del Izq Jeep Cherokee 94 y 98-01; Grand Cherokee 4X2 ABS 93-98; Grand Cherokee 4X4ABS 93-98; Wrangler 97-06.
380896	BH380896	10.6"	Sin Rosca	M10 X 1	Chevrolet Lumina 97-99 Tras Izq USA
38897	BH38897	18.75"	Sin Rosca	3/8 X 24	Ford Del Izq F-250 92-94; F-350 84-94. la Der es la 4036
38898	BH38898	23.75"	Sin Rosca	3/8 X 24	Ford F-200 F-250 89-96; F-300 F-350 90-94 Del USA
38899	BH38899	20.88"	Sin Rosca	3/8 X 24	Ford Del Der F-150 92-96, Bronco 90-92 USA
38900	BH38900	20.88"	Sin Rosca	3/8 X 24	Ford Del Izq F-150 92-96, Bronco 90-92 USA
38903	BH38903	20.25"	Sin Rosca	3/8 X 24	Ford Del Der Explorer XLS V6 , XLT V8, Limited 91
38904	BH38904	20.25"	Sin Rosca	(2) 3/8 X 24	Ford Del Izq Explorer XLS V6 , XLT V8, Limited 91
38905	BH38905	17.88"	Sin Rosca	M10 X 1	Chevrolet Del Der Cavalier 92-94 Cavalier Z24 92-94.
38906	BH38906	17.88"	Sin Rosca	M10 X 1	Chevrolet Del Izq Cavalier 92-94, Cavalier Z24 92-94.
38916	BH38916	13.63"	M10 X 1	M10 X 1	Toyota Pickup 84-95 Del USA
38942	BH38942	20.88"	Sin Rosca	M10 X 1	Isuzu Pickup 88-95 Del USA
38947	BH38947	24.63"	Sin Rosca	3/8 X 24	Ford Del DerFord F-450 Super Duty 97-98, F-450 V8 Super Duty XL 99-02
38950	BH38950	24.63"	Sin Rosca	(2) 3/8 X 24	Ford Del Izq Ford F-450 Super Duty 97-98, F-450 V8 Super Duty XL 99-02
38951	BH38951	12.5"	M10 X 1	M10 X 1	Chevrolet Tras Cadillac De Ville 91-93, Bonneville 94-99, Oldsmobile88, 92 y 94-95, CadillacDeville/Concours 94-96
38961	BH38961	13.88"	7/16 X 24	3/8 X 24	Ford Tras, Der Sable Vagoneta 94-95.
38968	BH38968	21.13"	Sin Rosca	M12 X 1.5	Chevrolet GMC 60 Series 88-92, GMC 70 Series 89 y 91 Del
38978	BH38978	7.5"	M10 X 1	M10 X 1	Mitsubishi Truck 94-95 Del USA
38982	BH38982	21.63"	Sin Rosca	M10 X 1	Nissan Del Izq Der Infiniti Q45 94-96.
38983	BH38983	21.5"	Sin Rosca	M10 X 1	Nissan Infiniti Q-45 94-96. Tras. Izq. Der.
38985	BH38985	18"	M10 X 1 Int	Sin Rosca	Geo Metro 92-01 Del USA
38986	BH38986	11.5"	M10 X 1	M10 X 1	Toyota Tacoma SR5 06-11 Del Izq Der
38997	BH38997	14"	M10 X 1.5	Sin Rosca	Ford Delantero, Izq Cougar 90-92, Thunderbird 90-92
380009	BH380009	14.5"	M10 X 1	M10 X 1	Mercedes Benz S500L 93-94, SL320 95-97, SL500 95-02, SL600 95-02 Del Iz Der
380038	BH380038	15"	(2) 3/8 X 24	3/8 X 24	Jeep Cherokee Sport 94 y 98-01 Tras.
380039	BH380039	19.5"	Sin Rosca	3/8 X 24	Chrysler Del Izq Dodge Dakota 96.
380040	BH380040	19.5"	Sin Rosca	3/8 X 24	Chrysler Del Der Dodge Dakota 96.
380041	BH380041	11.75"	Sin Rosca	3/8 X 24	Ford Del Izq Grand Marquis 92-94, Lincoln Town Car 91-94.
380042	BH380042	11.25"	3/8 X 24	Sin Rosca	Ford Del Der Grand Marquis 92-94, Lincoln Town Car 91-94.
380043	BH380043	12.25"	Sin Rosca	M10 X 1	Ford Grand Marquis 92-97 Tras. Der.
380044	BH380044	12"	Sin Rosca	(2) M10 X 1	Ford Grand Marquis 92-97 Tras. Izq.
380046	BH380046	21.36"	3/8 X 24	Sin Rosca	Ford Grand Marquis 99-02, F-150 94-96, Lincoln Town Car 99-0 Tras.
380047	BH380047	17.16"	Sin Rosca	M10 X 1	Chevrolet Del Der Lumina APV 95-96, Silhouette 92 y 94-95
380048	BH380048	17.16"	Sin Rosca	M10 X 1	Chevrolet Del Izq Lumina APV 95-96, Silhouette 92 y 94-95
380055	BH380055	26.25"	Sin Rosca	M10 X 1	Honda Civic 92-95 Del Der USA Sin ABS
380056	BH380056	26.55"	Sin Rosca	M10 X 1	Honda Civic 92-95 Del Der USA Con ABS
380058	BH380058	26.25"	Sin Rosca	M10 X 1	Honda Civic 92-95 Del Izq USA
380062	BH380062	18.5"	Sin Rosca	M10 X 1	Honda Civic 97-00 Tras Der
380064	BH380064	19"	Sin Rosca	M10 X 1	Honda Civic Coupe 97-00 Tras. Izq.
380070	BH380070	17.13"	3/8 X 24	3/8 X 24	Chrysler Grand Voyager 91-95 Tras, Town & Country 93 Tras, Voyager 97-00 Tras.
380071	BH380071	23"	Sin Rosca	3/8 X 24	Chrysler Del Der Imperial 91, Shadow 90, Grand Voyager 91-95, Town & Country 93-95, Voyager 94-95
380072	BH380072	22.75"	Sin Rosca	3/8 X 24	Chrysler Del Izq Imperial 91, Shadow 90, Grand Voyager 91-95, Town & Country 93-95, Voyager 94-95
380073	BH380073	22.75"	3/8 X 24	3/8 X 24	Chrysler Del Der Le Baron 92-95, New Yorker 90-94,Phantom 90-94, Shadow 91-94, Spirit 91-95,Spirit Rt 91-95, Voyager 94-95.
380074	BH380074	22.5"	3/8 X 24	3/8 X 24	Chrysler Del Izq Le Baron 92-95, New Yorker 90-94,Phantom 90-94, Shadow 91-94, Spirit 91-95,Spirit Rt 91-95, Voyager 94-95.
380075	BH380075	24"	3/8 X 24	3/8 X 24	Ford E-150 92-93 Del Der USA
380076	BH380076	22.5"	Sin Rosca	3/8 X 24	Ford E-150 92-93 Del Izq USA
380077	BH380077	23"	Sin Rosca	3/8 X 24	Ford P-350 Microbus 92-93 Del Izq.
380089	BH380089	16.5"	Sin Rosca	M10 X 1	Chrysler Tras Der Concorde 93-97, Intrepid 94-97, New Yorker Lh 94-95, Lhs 96-97





No. PARTE LUSAC	No. PARTE RAYBESTOS	LARGO	MEDIDA DE CUERDA DE CONECTORES		APLICACIÓN
380091	BH380091	19.25"	3/8 X 24	M10 X 1	Chrysler LHS 94-97; Concorde 93-97; Intrepid 93-97; New Yorker 94-91 Tras Der
380092	BH380092	18"	3/8 X 24	M10 X 1	Chrysler LHS 94-97; Concorde 93-97; Intrepid 93-97; New Yorker 94-91 Tras Izq
380094	BH380094	17.05"	Sin Rosca	M10 X 1	Chevrolet Luv 01-05 Nacional, Isuzu Rodeo 96-97 Del USA
380103	BH380103	21.25"	Sin Rosca	M10 X 1	Nissan Del Izq Der Quest Xe 97-02
380104	BH380104	13.75"	M10 X 1	M10 X 1	Nissan Quest XE 97-98. Tras. Izq. Der.
380105	BH380105	10"	M10 X 1	M10 X 1	Chevrolet Beretta 92-93 Del Der USA
380108	BH380108	22"	Sin Rosca	M10 X 1	Nissan Del Der Infiniti Q45 97-02
380110	BH380110	22"	Sin Rosca	M10 X 1	Nissan Del Izq Infiniti Q45 97-02, Sentra 1.6Lts 92
380154	BH380154	21.91"	M10 X 1	M10 X 1	Saab 900 86-88 Del Izq Der USA
380189	BH380189	21.75"	3/8 X 24	3/8 X 24	Jeep Grand Cherokee 93-98. Tras.
380192	BH380192	12"	Sin Rosca	M10 X 1	Chevrolet Del Izq-Der Corvette 93
380193	BH380193	20"	Sin Rosca	M10 X 1	Ford Tras Der Cougar XR-7 90-94, Cougar 93-95, Lincoln Mark VIII 94-96, Thunderbird 93-96 y 03-04Freno de Disco Trasero (Sistema de Frenos ABS)
380194	BH380194	25.25"	Sin Rosca	M10 X 1	Ford Tras Izq Cougar XR-7 90-94, Cougar 93-95, Lincoln Mark VIII 94-96, Thunderbird 93-96 y 03-04Freno de Disco Trasero (Sistema de Frenos ABS)
380195	BH380195	24.5"	Sin Rosca	3/8 X 24	Ford P-350 92-93 Del Der
380196	BH380196	18"	3/8 X 24	Sin Rosca	Ford Tras F-150 92-95 y 97-99, F-250 92-96, F-250 y Suerp Duty 98-00, F-350 93-04. P-350 Microbus97.
380206	BH380206	18"	Sin Rosca	M10 X 1	Chrysler Del Der Concorde 93-97 y 01-02, Intrepid 94-01, New Yorker Lh 94-95, Lhs 96-97, 300-M 99-04. Sistema de Frenos ABS Sustituye a la manguera 381055
380207	BH380207	21.5"	Sin Rosca	M10 X 1	Chrysler Del Izq Concorde 93-97 y 01-02, Intrepid 94-97, New Yorker Lh 94-95, Lhs 96-97. Sistema deFrenos ABS
380214	BH380214	20"	M10 X 1	M10 X 1	Ford Tras Der Cougar 93-95, Thunderbird 93-96
380215	BH380215	17.88"	M10 X 1	M10 X 1	Ford Tras Izq Cougar 93-95, Thunderbird 93-96
380216	BH380216	19.75"	Sin Rosca	3/8 X 24	Chrysler Dodge B-100, 150 94-97; Dodge B-200 94-97 Del Izq USA
380217	BH380217	21"	Sin Rosca	3/8 X 24	Chrysler Del Izq Dodge Ram Van y Ram Wagon 1500 95-97, Ram Van y Ram Wagon 2500 96-97,Ram Van y Ram Wagon 3500 95-97. la Der es 38200
380223	BH380223	13"	M10 X 1	M10 X 1	Nissan Tras, Izq Der Altima Disco Tambor 96-01 Hikari 88-92
380224	BH380224	19.88"	Sin Rosca	M10 X 1	Nissan Altima 96-01, Del Izq Der. (solo con disco en las 4 ruedas); Hikari 88-92, Del Izq Der.
380225	BH380225	7.75"	3/8 X 24	Sin Rosca	Jeep Grand Cherokee 95-98. Tras. Der. (Con disco en las 4 rueddas)
380226	BH380226	8.75"	3/8 X 24	Sin Rosca	Jeep Grand Cherokee 95-98, Del Izq. (Con disco en las 4 rueddas)
380227	BH380227	14.13"	M10 X 1	M10 X 1	Volvo C 70 99-01, Del. Izq. Y Der; S 70 99-00 Del Izq. Der; V 70 Vagoneta 99-04 Del. Izq Der. (D-T).
380228	BH380346	19.88"	Sin Rosca	3/8 X 24	Jeep Del Der Jeep Wrangler 93-96
380229	BH380347	21"	Sin Rosca	3/8 X 24	Jeep Del Izq Jeep Wrangler 93-96
380248	BH380248	20.63"	Sin Rosca	3/8 X 24	Chevrolet Del Izq C20, C25 Pick Up 95-99. 8600 libras.
380249	BH380249	20.63"	Sin Rosca	3/8 X 24	Chevrolet Del Der C20, C25 Pick Up 95-99. 8600 Libras.
380259	BH380259	15.5"	Sin Rosca	M10 X 1	Chevrolet Del Izq Corvette 94-96
380261	BH380261	18.25"	Sin Rosca	M10 X 1	Chevrolet Del Izq Pontiac Bonneville 94-99; Oldsmobile88 94-95
380263	BH380263	15"	Sin Rosca	3/8 X 24	Ford Del Der Mustang GT 94-98, Cobra 97
380264	BH380264	18.5"	Sin Rosca	M10 X 1	Ford Del Der Windstar, GL, LX 95-98, C/ Control de Traccion
380265	BH380265	18.25"	Sin Rosca	M10 X 1	Ford Del Izq Windstar, GL, LX 95-98, C/ Control de Traccion
380268	BH380268	12.63"	Sin Rosca	M10 X 1	Chevrolet Cadillac Seville STS 98. Tras. Der.
380271	BH380271	12.5"	Sin Rosca	M10 X 1	Chevrolet Del Der Pontiac Bonneville 94-99; Oldsmobile88 94-95
380272	BH380272	12.38"	Sin Rosca	M10 X 1	Chevrolet Cadillac De Ville, El Dorado 94-95. Seville 94-95. Tras.Izq.
380280	BH380280	12.13"	Sin Rosca	M10 X 1	Chevrolet Del Izq-Der Blazer 95-97, S10 Pick Up 95-99
380282	BH380282	37.5"	1/2 X 20	1/2 X 20	Chevrolet Panel P-30, 94-98, Del Izq. Der.
380283	BH380283	42.75"	3/8 X 24	1/2 X 20	Chevrolet P-30 94 Del Izq USA
380284	BH380284	37.5"	1/2 X 20	1/2 X 20	Chevrolet P-30 94 Del Izq USA
380285	BH380285	42.75"	1/2 X 20	1/2 X 20	Chevrolet P-30 93-94 Del Izq USA
380289	BH380289	11.75"	M10 X 1	M10 X 1	Chevrolet Firebird Trans Am 98-01. Tras. Izq.
380295	BH380295	34"	3/8 X 24	Sin Rosca	Chrysler Dodge Ram 1500 95-99; Ram 2500 95-99 Del Izq USA
380296	BH380296	11"	Sin Rosca	M10 X 1	Ford Del Der Grand Marquis 95-97, Lincoln Town Car 95-00



No. PARTE LUSAC	No. PARTE RAYBESTOS	LARGO	MEDIDA DE CUERDA DE CONECTORES		APLICACIÓN
380297	BH380297	11"	Sin Rosca	M10 X 1	Ford Del Izq Grand Marquis 95-97, Lincoln Town Car 95-00
380298	BH380298	19.5"	Sin Rosca	3/8 X 24	Ford Del Der F-150 94-95
380299	BH380299	19"	Sin Rosca	3/8 X 24	Ford Del Izq F-150 94-95
380303	BH380303	19.5"	Sin Rosca	3/8 X 24	Chrysler Del Izq Dodge Ram 1500 95-99, Ram 2500 95-99, Ram 3500 97-99, Ram Charger 99, RamRunner V10 97
380304	BH380304	14.63"	Sin Rosca	3/8 X 24	Chrysler Tras Izq Dodge Cirrus 96-97, Sebring R/T 97, Stratus 96-97; (F. Disco Tras.)
380305	BH380305	17.75"	Sin Rosca	3/8 X 24	Chrysler Delatera Der Dodge Breeze 96, Cirrus 96-00, Stratus 95-02.
380306	BH380306	18.38"	Sin Rosca	3/8 X 24	Chrysler Delatera Izq Dodge Breeze 96, Cirrus 96-00, Stratus 95-02.
380307	BH380307	18.38"	3/8 X 24	3/8 X 24	Chrysler Tras Der Dodge Breeze 96; Stratus 95-00.
380308	BH380308	14.13"	3/8 X 24	3/8 X 24	Chrysler Tras Izq Dodge Breeze 96; Stratus 95-00.
380309	BH380309	16.13"	3/8 X 24	Sin Rosca	Chrysler Tras Der Dodge Cirrus 96-97, Sebring R/T 97, Stratus 96-97; (F. Disco Tras.)
380310	BH380310	21"	Sin Rosca	(2) 3/8 X 24	Ford Del Izq Explorer XLS V6, XLT V8, Limited 92
380311	BH380311	19.13"	Sin Rosca	3/8 X 24	Ford Del Der Explorer XLS V6, XLT V8, Limited 92
380312	BH380312	23.13"	Sin Rosca	M10 X 1	Eagle Vision 95 Tras Der USA
380317	BH380317	21.5"	Sin Rosca	3/8 X 24	Ford Del Der Explorer XLS V6, XLT V8, Limited 93-94
380318	BH380318	21"	Sin Rosca	3/8 X 24	Ford Del Izq Explorer XLS V6, XLT V8, Limited 93-94
380319	BH380319	22.75"	Sin Rosca	3/8 X 24	Ford Del Der Bronco 94-96 USA
380320	BH380320	21.5"	Sin Rosca	3/8 X 24	Ford Del Izq Bronco 94-96 USA
380322	BH380322	23.75"	Sin Rosca	3/8 X 24	Ford P-350 Microbus 94-95, Del Der.
380323	BH380323	20.75"	Sin Rosca	3/8 X 24	Ford Del Izq Econoline E-150 00-03, E-150 Club Wagon 95-05
380324	BH380324	22.75"	Sin Rosca	3/8 X 24	Ford Del Der Econoline E-150 95-03, Econoline Van E-150 95-07, E-150 Club Wagon 95-05
380325	BH380325	24.75"	M10 X 1	M10 X 1	Ford Windstar GL, LX, 95-03. Tras. Der.
380326	BH380326	24.75"	M10 X 1	M10 X 1	Ford Windstar GL, LX, 95-03. Tras. Izq.
380329	BH380329	24"	3/8 X 24	Sin Rosca	Chrysler Tras Der Dodge Neon 95-99 ; (F. Disco Tras.)
380330	BH380330	24"	3/8 X 24	Sin Rosca	Chrysler Tras Izq Dodge Neon 95-99. (F. Disco Tras.)
380331	BH380331	20.75"	Sin Rosca	3/8 X 24	Chrysler Del Der Dodge Neon 95
380332	BH380332	20.75"	3/8 X 24	Sin Rosca	Chrysler Del Izq Dodge Neon 95
380333	BH380333	20.75"	3/8 X 24	Sin Rosca	Chrysler Del Der Dodge Neon 95-99.
380334	BH380334	20.75"	3/8 X 24	Sin Rosca	Chrysler Del Izq Dodge Neon 95-99.
380335	BH380335	17.13"	3/8 X 24	3/8 X 24	Chrysler Neon 95 Tras Der
380336	BH380336	17.13"	3/8 X 24	3/8 X 24	Chrysler Neon 95 Tras Izq
380337	BH380337	17.75"	3/8 X 24	3/8 X 24	Chrysler Tras Der Dodge Neon 95-99. (F. Tambor Tras.) A.B.S.
380338	BH380338	17.13"	3/8 X 24	3/8 X 24	Chrysler Tras Izq Dodge Neon 95-99. (F. Tambor Tras.) A.B.S.
380339	BH380339	19"	3/8 X 24	Sin Rosca	Chrysler Del Izq Dodge Ram 1500 94-99, Ram y Club Cab 2500 94-96, Ram 3500 94-97
380340	BH380340	18.75"	3/8 X 24	Sin Rosca	Chrysler Del Der Dodge Ram 1500 94-99. Ram 2500 94-99, Ram 2500 Club Cab 94-96, Ram 3500 94-99, Ram Van y Wagon 3500 98-99, Ram Charger 99.
380342	BH380342	19"	3/8 X 24	Sin Rosca	Chrysler Del Der Dodge Ram 1500 94-99, Ram 2500 4X2 94, Ram Runner V-10 97
380343	BH380343	39.25"	3/8 X 24	Sin Rosca	Chrysler Del Izq Dodge Ram 1500 94-97, Ram 2500 94-97, Ram 3500 94-97, Ram 4000 95-97.
380344	BH380344	39.25"	Sin Rosca	3/8 X 24	Chrysler Del Der Dodge Ram 1500 4X4 95-99, Ram 2500 4X4 94-99, Ram 3500 94-99, Ram Van3500 y Ram Wagon 3500 00-01, Ram 4000 95-99. Ram SRT 05-06
380345	BH380345	39.25"	Sin Rosca	3/8 X 24	Chrysler Dodge Ram 1500 94-97, Ram 2500 94 Del Izq
380353	BH380353	21"	Sin Rosca	3/8 X 24	Ford F-200 F-250 95-98; F-300, F-350 95-97 Del Izq USA
380354	BH380354	20.25"	Sin Rosca	3/8 X 24	Ford F-200 F-250 95-98; F-300, F-350 95-97 Del Der USA
380355	BH380355	24"	Sin Rosca	3/8 X 24	Ford Del Izq Club Wagon V8 E-350 XL 99-06, Club Wagon V8 E-250 Chateau 98-00, Econoline Wagon V8 E-250 Chateau 99-00 98-00; Econoline Van E-250 97-99, Econoline Van E-350 98-99 y 06-07, Econoline Van E-350 Diesel 06-07, Econoline Wagon Diesel 01 Y 03, F-150 00-04 ABS Ruedas Tras





No. PARTE LUSAC	No. PARTE RAYBESTOS	LARGO	MEDIDA DE CUERDA DE CONECTORES		APLICACIÓN
380356	BH380356	21.5"	Sin Rosca	3/8 X 24	Ford Del Der Expedition XLT, Eddie Bauer 00-02, Club Wagon V6E-150 95-98, Econoline Van E150 95-07, Econoline Wagon E-150 99-07, Econoline Club Wagon E-150 95-96, F-150 00-04 ABS Ruedas Tras, Lincoln Navigator 01-02
380357	BH380357	13.25"	Sin Rosca	3/8 X 24	Ford Del Der Explorer XLS V6 XLT V8 Limited 95-97; Ranger 03-11, Explorer Sport 98-03
380358	BH380358	13.25"	Sin Rosca	3/8 X 24	Ford Del Izq Explorer XLS V6 XLT V8 Limited 95-97; Ranger 03-11, Explorer Sport 98-03
380360	BH380360	15.25"	M10 X 1	Sin Rosca	Ford Lincoln Continental 97 Tras Izq
380361	BH380361	18.5"	Sin Rosca	M12 X 1	Ford Delantra Der Lincoln Continental 97-99
380362	BH380362	18.5"	Sin Rosca	M12 X 1	Ford Del Izq Lincoln Continental 97-99
380369	BH380369	20.5"	Sin Rosca	3/8 X 24	Ford Bronco 93 Del Der USA
380371	BH380371	11"	Sin Rosca	7/16 X 24	Ford Mustang GT 94-98 Tras. Der.
380372	BH380372	10.25"	Sin Rosca	7/16 X 24	Ford Mustang GT 94-98 Tras. Izq..
380373	BH380373	16"	Sin Rosca	7/16 X 24	Ford Del Der Cougar, 93-95, XR-7 90-94; Thunderbird 93-96
380374	BH380374	16"	Sin Rosca	7/16 X 24	Ford Del Izq Cougar, 93-95, XR-7 90-94; Thunderbird 93-96
380375	BH380375	47.5"	Sin Rosca	3/8 X 24	Ford F-450 Super Duty 97-98 Del Der
380376	BH380376	27.75"	Sin Rosca	3/8 X 24	Ford Tras Izq Explorer XLS V6, XLT V8, Limited 95-05, Explorer Sport 98-05, C/ Control de VelocidadDisco Disco
380378	BH380378	16"	Sin Rosca	M10 X 1	Ford Del Der Lincoln Mark VIII 94-96
380379	BH380379	16"	Sin Rosca	M10 X 1	Ford Del Izq Lincoln Mark VIII 94-96
380380	BH380380	12.75"	Sin Rosca	M10 X 1	Ford Tras Der Lincoln Town Car 95-96
380383	BH380383	16.75"	Sin Rosca	3/8 X 24	Ford Del Der F-250 95-97; F-350 95-98; P-350 Microbus 94-97
380384	BH380384	20"	Sin Rosca	(2) 3/8 X 24	Ford Del Izq F-250 95-97; F-350 95-98; P-350 Microbus 94-97
380385	BH380385	18"	3/8 X 24	3/8 X 24 Int7/16 X 24 Ext	Ford Econoline E-150 95-06, Econoline Van E-150 95-05, Econoline Van E-250 97-99, Econoline E- 350 95-99 y 06, Econoline Van E-350 98-99. y 06-07. Econoline Van E-350 Diesel 06-07, Club Wagon V-6 E-150 95-07. Club Wagon V-8 E-250 95-04. Econoline Wagon Diesel 01 y 03 Trasera Central
380387	BH380387	16.5"	Sin Rosca	3/8 X 24	Ford Del Der Club Wagon V8 E-250 95-04 Econoline Club Wagon E-250 99-04, Econoline Wagon Diesel 01 y 03, Club Wagon V8 E-350 XL 95-06, Club Wagon V8 E-350 Chateau 95-98, Econoline Wagon V8 E-250 Chateau 99-00 ABS Ruedas Tras sin Control de Velocidad 98-00; Econoline Van E- 250 con Control de Velocidad 97-99; Econoline Van E-350 98-99 y 06-07, Econoline Van E-350 Diesel 06-07, Club Wagon V8 E-250 Chateau 95-96 y 98-00, Econoline Van E-250 97-99
380388	BH380388	16.75"	Sin Rosca	3/8 X 24	Ford Econoline Van E-250 98-99 Del Izq; Club Wagon V8 E-250 95-04 Del. Izq, Club Wagon V8 E-250 Chateau 95-96 Del. Izq.
380389	BH380389	22.75"	Sin Rosca	3/8 X 24	Ford Ranger 4X4 96-97 Nacional, Ford Ranger 4X4 95, Mazda B2300 95-97, B3000 95-97, B400095-97 Del Der USA
380391	BH380391	20.75"	Sin Rosca	3/8 X 24	Ford Del Izq Ranger 96-97 Nacional, Ranger 95 Mazda B2300 95-97, B3000 95-97, B4000 95-97 Dellzq USA.
380392	BH380392	20.25"	Sin Rosca	3/8 X 24	Ford Del Izq Ranger 96-97 Nacional, Ranger 95 Mazda B2300 95-97, B3000 95-97, B4000 95-97 DelDer USA.
380395	BH380395	8"	Sin Rosca	M10 X 1	Honda Accord L4 96-97 Tras. Izq. Der.
380398	BH380398	21.25"	Sin Rosca	M10 X 1	Ford Club Wagon V8 E-250 Chateau 99-00 Del. Izq.
380406	BH380406	12.5"	Sin Rosca	M10 X 1	Chevrolet Tras Izq-Der Cadillac Deville 00-04, Cadillac Seville STS 99-01, Del Izq-Der Camaro 95-97,Firebird, Trans Am 94-97.
380411	BH380411	16.5"	Sin Rosca	3/8 X 24	Ford Del Der Ranger 4X2 96-97
380414	BH380414	14"	Sin Rosca	3/8 X 24	Chevrolet Cadillac De Ville, El Dorado 94-95, Seville 94-96. Tras.Der.
380415	BH380415	15"	Sin Rosca	M12 X 1	Ford Sable 96-04. Lincoln Continental 98-99. Tras. Der.
380416	BH380416	15.5"	Sin Rosca	M10 X 1	Ford Sable 96-04. Lincoln Continental 98-99. Tras. Izq.
380417	BH380417	15.5"	M12 X 1	M12 X 1	Ford Sable 96-05 Tras Der
380418	BH380418	15.5"	M10 X 1	M10 X 1	Ford Sable 96-05 Tras Izq
380419	BH380419	22.5"	Sin Rosca	3/8 X 24 Int M12 X 1 Ext	Ford Del Der Sable, 96- 04
380421	BH380421	15.25"	M10 X 1	M10 X 1	Ford Del Izq-Der Contour 96-00; Mystique 95-00
380422	BH380422	12"	M10 X 1	M10 X 1	Ford Contour 96-97. Mystique 95-96. Tras Izq. Der. F. Tambor
380423	BH380423	22.25"	M10 X 1	M10 X 1	Ford Contour 96-97. Mystique 95-96. Tras Izq. Der. F. Disco
380451	BH380451	11.75"	M10 X 1	M10 X 1	Ford Tras Izq Escape 01-06.

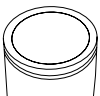



No. PARTE LUSAC	No. PARTE RAYBESTOS	LARGO	MEDIDA DE CUERDA DE CONECTORES		APLICACIÓN
380452	BH380452	8.75"	M10 X 1	M10 X 1	Audi A8 04-10, Audi S8 07-09 Tras. Izq. Der., Volkswagen Passat 99-05 Tras. Izq. Der.
380455	BH380455	14.25"	M10 X 1	M10 X 1	Volkswagen Eurovan L-5 2.5 Lts 01-05 Del. Izq. Der; Eurovan VR6 2.8 Lts. 00-02 Del Izq. Y Der.
380456	BH380456	14"	M10 X 1	M10 X 1	Volkswagen. Del Der-Izq Passat 91-93, Passat Vagoneta 91-92.
380457	BH380457	19"	M10 X 1	M10 X 1	Volkswagen. Del Der - Izq Golf A3 CL, GL 93-99, Golf A3 GLS 93-99, Golf Cabrio A3 96-99, Golf Cabrio A4 00-01; Golf GTI A3 93-98; Golf GTI VR6 95, Jetta GLS y Europa A3 93-98
380459	BH380459	17.5"	7/16 X 24	3/8 X 24	Chrysler Grand Voyager 96-02, Voyager 96, Town & Country 96-98 Tras
380460	BH380460	20.25"	Sin Rosca	M10 X 1	Chrysler Del Der Voyager 96-00. Grand Voyager 96-00, Town & Country 96-00
380461	BH380461	20.25"	Sin Rosca	3/8 X 24	Chrysler Del Izq Voyager 96-00. Grand Voyager 96-00. Town & Country 96-00
380463	BH380463	16.25"	Sin Rosca	M10 X 1	Ford Del Der-Izq Escort, Escort LX 94-01; Escort Vagoneta 94-99; Escort GT 94-95
380466	BH380466	12.5"	Sin Rosca	M10 X 1	Chevrolet Lumina 95-96 Tras USA
380467	BH380467	12.5"	Sin Rosca	M10 X 1	Chevrolet Del Izq-Der Cavalier 95-04, Cavalier Z24 95-96, Gran Am 99-04, Malibu LX 97-01, MalibuLS V6 97-04, Sunfire 97-05
380469	BH380469	10"	Sin Rosca	3/8 X 24	Chevrolet C-35, C-3500, C3500 HD 96-00, Del. Der; Blazer 98-99, Del. Der; Blazer 00-01, Del. Izq. y Der.
380473	BH380473	8.75"	M10 X 1	M10 X 1	BMW Serie 3 323i 98-01, 325i 95-97, 328i 96-98, Tras Izq Der, 328i 98-01 Del. Izq. Y Der.
380476	BH380476	18.75"	M10 X 1	M10 X 1	BMW Serie 3 Z 3 96-02, Del Izq Der; Serie 3 M3 95-99, Del Izq Der.
380478	BH380478	12.25"	Sin Rosca	M10 X 1	Chevrolet Buick Regal 95-96. Tras Izq.
380481	BH380481	12"	(2) 3/8 X 24	7/16 X 24	Chevrolet Firebird, Trans Am 93 Tras USA
380483	BH380483	7.75"	Sin Rosca	M10 X 1	Chevrolet Camaro Tras. 95-97, Camaro Z-28 98-02. Firebird Trans Am 94-97, Venture APV 98-04. Tras. Izq. Der, Firebird Trans Am 98-01, Pontiac Montana SV6 05 Tras. Der.
380486	BH380486	23.25"	Sin Rosca	M10 X 1	Nissan Tras Der Infiniti I-30 98-01, Maxima 95-01
380487	BH380487	23.25"	Sin Rosca	M10 X 1	Nissan Infiniti I-30 98-01. Maxima 95-01 Tras. Izq.
380489	BH380489	18.25"	Sin Rosca	M10 X 1	Nissan Del Der Sentra 1.6 Lts 96-00, Sentra 2.0 Lts 96-01, Altima 2.0 Lts 96-01 Tsuru GSR 2000 93-96, Lucino GSE y GSR 96-00, Sentra 1.8 Lts 01 Nacional, Nissan Del Der 200 Sx 95-97 USA
380490	BH380490	18.25"	Sin Rosca	M10 X 1	Nissan Del Izq Sentra 1.6 Lts 96-00, Sentra 2.0 Lts 96-01, Altima 2.0 Lts 96-01 Tsuru GSR 2000 93-96, Lucino GSE y GSR 96-00, Sentra 1.8 Lts 01 Nacional, Nissan Del Izq. Nissan 200 Sx 95-97 USA
380499	BH380499	22.25"	7/16 X 24	7/16 X 24	Chevrolet GMC 50 Series 93-94, GMC 60 Series 93-95, GMC 70 Series 93-95 Tras Izq
380507	BH380507	21.5"	Sin Rosca	M10 X 1	Nissan Tras Der Sentra 1.6 Lts (F. Disco) 96-00, Sentra 2.0 Lts 96-01 Tsuru GSR 2000 93-96, Lucino GSE y GSR 96-00, Sentra 1.8 Lts 01.
380508	BH380508	21.25"	Sin Rosca	M10 X 1	Nissan Tras Izq Sentra 1.6 Lts (F. Disco) 96-00, Sentra 2.0 Lts 96-01 Tsuru GSR 2000 93-96, Lucino GSE y GSR 96-00, Sentra 1.8 Lts 01.
380511	BH380511	19.06"	M10 X 1 Ext	M10 X 1 Int	Nissan D21 96-97 Tras
380512	BH380512	13.25"	M10 X 1	M10 X 1	Nissan Tras Sentra 1.6 Lts 96-00 Sentra 2.0 Lts 96-01
380516	BH380516	12.75"	M10 X 1	M10 X 1	Toyota Rav4 04-05 Tras Izq y Der
380517	BH380517	19.75"	M10 X 1	Sin Rosca	Nissan Del Der Izq Altima 96-02; Hikari 88-92
380520	BH380520	19.25"	Sin Rosca	3/8 X 24	Chevrolet Blazer 96-97 Tras. Blazer 00-01 Tras. Izq. Der.
380521	BH380521	14.25"	Sin Rosca	7/16 X 24	Ford Del Izq Mustang GT 94-98, Cobra 97
380528	BH380528	11"	Sin Rosca	3/8 X 24	Ford Explorer XLS V-6, XLT V-8, Limited 95-02. Explorer Sport 98-05. Tras. Der. Disco Disco
380531	BH380531	21"	Sin Rosca	M10 X 1	Ford Windstar GL, LX, SEL Limited 95-03. Tras Izq.
380532	BH380532	18.5"	Sin Rosca	3/8 X 24	Chrysler Del Izq Sebring R/T 97.
380533	BH380533	25.5"	Sin Rosca	3/8 X 24	Chevrolet K20, K25 Pickup 96-00 Del Izq USA
380534	BH380534	25.5"	Sin Rosca	3/8 X 24	Chevrolet K20, K25 Pickup 96-00 Del Der USA
380538	BH380538	17.75"	M10 X 1	M10 X 1	BMW Serie 3 325i 95-97, 328i 96-00, Del. Izq Der. Serie 3 Z3 96-02, BMW Z4 03-09 Del. Iz. Der.
380541	BH380541	32"	(2) 3/8 X 24	Sin Rosca	Chrysler Del Der Ram Charger 99, Ram 1500 4X4 97-99, Ram 2500 95-99, Del Izq Ram 3500 94-99, Ram Van 3500 4X4 00-01, Ram Wagon 3500 00-01, Ram 4000 98-99. Ram SRT 05-06





No. PARTE LUSAC	No. PARTE RAYBESTOS	LARGO	MEDIDA DE CUERDA DE CONECTORES		APLICACIÓN
380545	BH380545	22.25"	M10 X 1 Int	Sin Rosca	Chrysler Del Izq-Der Cirrus Coupe 99-00, Mitsubishi Eclipse Del Izq-Der 03-05
380549	BH380549	15"	M10 X 1	M10 X 1	Honda Accord Motor L4 96-97 Tras.
380552	BH380552	9.25"	M10 X 1	M10 X 1	Saab 9-3 01-05, Del. Der. (D-D)
380553	BH380553	21"	Sin Rosca	3/8 X 24	Ford Del Izq Expedition XLT, Eddie Bauer 97-99, F-150 4X2 ABS en ruedas traseras 96-04, F250 98-99, Lobo S/C/ de Velocidad 4X2 97-99
380554	BH380554	21"	Sin Rosca	3/8 X 24	Ford Del Der Expedition XLT, Eddie Bauer 97-02; F150 97-04; F250 98-02, F-150 4X2 ABS en ruedastraseras 99-04, Lobo S/C/ de Velocidad 4X2 97-99, Lincoln Navigator 98-02
380555	BH380555	17.75"	Sin Rosca	(2) 3/8 X 24	Ford Del Izq Expedition XLT, Eddie Bauer 4X4 97-99; Lobo sin Control de Velocidad 4X4 97-98 y 00-04, Lincoln Navigator 98-00
380556	BH380556	43.25"	Sin Rosca	3/8 X 24	Ford Del Der Expedition XLT Eddie Bauer 4X4 97-99, F-150 4X4 ABS 99-04, Lobo sin Control de Velocidad 4X4 97-98 y 00-04, Lincoln Navigator 98-00
380557	BH380557	12.5"	Sin Rosca	M10 X 1	Chevrolet Cadillac De Ville 96-99, El Dorado 96-97, Seville 97 Tras. Izq.
380565	BH380565	26.25"	M10 X 1 Int	M10 X 1 Ext	BMW Serie 7 740iL 98-01, 750iL 95-01, Serie 8 Z8 03 Tras Izq Der.
380579	BH380579	16"	3/8 X 24	Sin Rosca	Chrysler Del Der Sebring R/T 97.
380580	BH380580	10.75"	Sin Rosca	M10 X 1	Chevrolet Pontiac Grand Am 99-04, Grand Prix GT, GTP, SE 97-98, Tras. Izq. Der.
380581	BH380581	15.5"	Sin Rosca	M10 X 1	Chevrolet Del Izq-Der Grand Prix GT, GTP, Se 97-01, Impala 00-04, Venture APV 97-04, Pontiac Montana SV6 05
380587	BH380587	21.33"	Sin Rosca	3/8 X 24	Chevrolet Del Der G-30 Express 3500 97-02, Express Cargo Van 3500 97-03, Express van 3500 8pasajeros 03
380588	BH380588	21.33"	Sin Rosca	3/8 X 24	Chevrolet Del Izq G-30 Express 3500 97-02, Express Cargo Van 3500 97-03, Express van 3500 8pasajeros 03
380716	BH380716	16.25"	(2) M10 X 1	M10 X 1	Nissan Pathfinder XE 97-03, Pathfinder Armada 04. Tras.
380747	BH380747	19.5"	Sin Rosca	(2) 3/8 X 24	Chrysler Del Izq Dodge Ram 1500 95-99, Ram 2500 4X2 95-99 Ram Charger 99, Ram 3500 95-99, Ram Van y Ram Wagon 3500 98-99.
380752	BH380752	22.75"	Sin Rosca	3/8 X 24	Chevrolet Del Izq G-15, 98-02 Express 1500, y Express Cargo Van 1500 98-02, G-20, Express 250099-01, Express Cargo Van 2500 99-01, Silverado 1500 98-02, Tigra 99
380753	BH380753	22.75"	Sin Rosca	3/8 X 24	Chevrolet Del Der G-15, 98-02 Express 1500, y Express Cargo Van 1500 98-02, G-20, Express 2500y Express Cargo Van 2500 99-01, Silverado 1500 98-02
380754	BH380754	16"	Sin Rosca	3/8 X 24	Honda Del Izq Civic LX C/ABS, 4 Ptas. T. Manual 97-01.
380756	BH380756	16.25"	Sin Rosca	M10 X 1	Honda Del Der Civic Ex 97-01. C/ABS. Trans. Aut
380758	BH380758	16.25"	Sin Rosca	M10 X 1	Honda Del Izq Civic Ex 97-01. C/ABS. Trans. Aut.
380761	BH380761	22.25"	Sin Rosca	M10 X 1	Nissan Del Izq Der Pathfinder 97-03, Pathfinder Armada 04, Pick Up Doble Cabina 97-00
380773	BH380773	23.25"	M10 X 1 Int	(2) M10 X 1 Int	Chrysler Dodge Durango 98-99 Tras Nacional, Chrysler Dodge Dakota 97-04 USA Tras
380785	BH380785	17.25"	Sin Rosca	M10 X 1	Honda Del Der Civic LX C/ABS, 4 Ptas. T. Manual 97-01.
380889	BH380889	17.85"	3/8 X 24	(2) 3/8 X 24	Jeep Wrangler 96-02, Jeep Wrangler Sahara 97-02, Jeep Wrangler Unlimited, Jeep Wrangler Rubicon03-06 Tras Central.
380897	BH380897	10.6"	Sin Rosca	M10 X 1	Chevrolet Lumina 97-99 Tras Der USA
380901	BH380901	17.98"	Sin Rosca	M10 X 1	Toyota RAV-4 04-05 Del Der
380902	BH380902	17.98"	Sin Rosca	M10 X 1	Toyota RAV-4 04-05 Del Izq
380907	BH380907	17.81"	N/D	N/D	Chevrolet Del Izq Cadillac Deville 94-99, El Dorado 94- 97, Seville 94-97, Seville STS 98-01
380908	BH380908	17.81"	N/D	N/D	Chevrolet Del Der Cadillac Deville 94-99, El Dorado 94- 97, Seville 94-97, Seville STS 98-01
380912	BH380912	7.4"	M10 X 1	M10 X 1	Chevrolet Oldsmobile Silhouette Van 97-02; Pontiac Trans Sport Van 97-98; Venture APV 97-05 TrasUSA
380913	BH380913	15.33"	M10 X 1	M10 X 1	Chevrolet Venture APV 97-04 Tras.
380920	BH380920	10.9"	Sin Rosca	7/16 X 24	Ford F-450 V8 Supe Duty 97-98 Del Izq
380931	BH380931	9.82"	Sin Rosca	3/8 X 24 Int	Ford. Ranger 4X4 98-04 Del Izq
380932	BH380932	18.75"	Sin Rosca	(2) 3/8 X 24	Ford Del Izq Ranger 4X2 98-07.
380935	BH380935	21.78"	3/8 X 24	3/8 X 24	Ford Tras Lincoln Blackwood 03, Navigator Interna 98-00, F-150 4X2 97-04; Lobo 97-99
380936	BH380936	24.28"	3/8 X 24	3/8 X 24	Ford Tras F-150 4X2 97-04, Lobo 4X4 sin Control de Velocidad 97-98 y 00-04, Expedition XLT, Eddie Bauer 97-99 Interna, Navigator 98-00 Interna



Buyers Guides



No. PARTE LUSAC	No. PARTE RAYBESTOS	LARGO	MEDIDA DE CUERDA DE CONECTORES		APLICACIÓN
380937	BH380937	19"	Sin Rosca	(2) M10 X 1 Int	Ford Tras Izq Lincoln Navigator 98-02, Expedition XLT, Eddie Bauer 97-02
380938	BH380938	14.62"	Sin Rosca	(2) 3/8 X 24 Int	Ford Ranger 97; Mazda B2300 97 Del Izq USA
380939	BH380939	20.98"	Sin Rosca	M10 X 1 Int	Ford Tras Der Lincoln Navigator 98-02, Expedition XLT, Eddie Bauer 00-02
380953	BH380953	16.13"	Sin Rosca	3/8 X 24	Ford Ranger 98-05. Tras Izq.
380955	BH380955	19.81"	Sin Rosca	7/16 X 24	Eagle Vision 96-97 Tras Der USA
380975	BH380975	17"	M10 X 1	M10 X 1	Chrysler Tras Der Stratus 95-00 (F. Tambor Con A.B.S.)
380976	BH380976	17.75"	M10 X 1	M10 X 1	Chrysler Tras Izq Stratus 95-00 (F. Tambor Con A.B.S.)
380977	BH380977	22.75"	Sin Rosca	3/8 X 24	Chrysler Cirrus 98-00, Stratus 98-02 Tras Der.
380978	BH380978	22.75"	Sin Rosca	3/8 X 24	Chrysler Cirrus 98-00, Stratus 98-02 Tras Izq.
380979	BH380979	17.5"	Sin Rosca	M10 X 1	Chrysler Del Izq Dodge Durango 98-99.
380980	BH380980	17.5"	Sin Rosca	M10 X 1	Chrysler Del Der Dodge Durango 98-99.
380992	BH380992	12.28"	M10 X 1	M10 X 1	Ford Tras Izq-Der Contour 98-00; Mystique 97-00 (F. Tambor) Tracc. Del
380993	BH380993	22.68"	M10 X 1	M10 X 1	Ford Tras Izq-Der Contour 98-00; Mystique 97-00 Disco Trasero
380996	BH380996	18.5"	7/16 X 24 Int	(2) 3/8 X 24	Chevrolet G20, G25 92-93 Tras USA
381008	BH381008	8.13"	Sin Rosca	M10 X 1 Int	Honda Accord 97 Tras USA
381019	BH381019	19.33"	Sin Rosca	M10 X 1	Volkswagen. Del Izq-Der Golf A3 GTI VR6 96-98, Jetta VR6 A3 96-98.
381025	BH381025	17.28"	Sin Rosca	M10 X 1	Honda Del Der Accord L4 98-02 Accord V6 98-02
381026	BH381026	17.28"	Sin Rosca	M10 X 1	Honda Del Izq Accord L4 98-02 Accord V6 98-02
381032	BH381032	19.12"	Sin Rosca	3/8 X 24 Int	Chevrolet Blazer 98-99, S-10 Pick Up 4X4 98-99 Delantera Izquierda
381033	BH381033	19.12"	Sin Rosca	3/8 X 24 Int	Chevrolet Blazer 98-99, S-10 Pick Up 4X4 98-99 Delantera Derecha
381046	BH381046	12.5"	M10 X 1 Int	M10 X 1 Int	Honda Tras Izq Der. Accord L4 98-00, Accord V6 98-02 (F. Tambor)
381052	BH381052	13.6"	Sin Rosca	3/8 X 24	Chrysler Intrepid 98-01, 300M 99-04 Tras. Izq.
381053	BH381053	13.6"	Sin Rosca	3/8 X 24	Chrysler Intrepid 98-01. 300M 99-04 Tras. Der.
381054	BH381054	14.38"	Sin Rosca	3/8 X 24	Chrysler Del Izq Dodge Intrepid 98-01 ABS; 300-M 99-04.
381055	BH381055	14.38"	Sin Rosca	3/8 X 24	Chrysler Del Der Dodge Intrepid 98-01 ABS; 300-M 99-04.
381056	BH381056	24"	Sin Rosca	M10 X 1	Chrysler Del Izq Dodge Durango 99-04.
381058	BH381058	34"	M10 X 1	M10 X 1	Chrysler Durango 98-99. Tras Izq Der
381060	BH381060	20.32"	Sin Rosca	M10 X 1 Int	Nissan 240SX 97-98 Del Der
381062	BH381062	10.47"	Sin Rosca	Sin Rosca	Ford F-200 F-250 97-99 Tras Der USA
381064	BH381064	12.73"	Sin Rosca	3/8 X 24 Int	Chevrolet Blazer 98-99 Nacional; GMC Jimmy 98-01Tras USA
381065	BH381065	11.93"	Sin Rosca	3/8 X 24 Int	Oldsmobile Bravada 97 Tras USA
381066	BH381066	18.32"	Sin Rosca	3/8 X 24 Int	Oldsmobile Bravada 97 Del Izq USA
381067	BH381067	18.32"	Sin Rosca	3/8 X 24 Int	Oldsmobile Bravada 97 Del Der USA
381070	BH381070	16.5"	M12 X 1	M10 X 1.5	Ford Lincoln Continental 97 Tras Der
381071	BH381071	18"	Sin Rosca	M10 X 1	Ford Grand Marquis 98-02, Lincoln Town Car 97-06 Tras. Izq.
381072	BH381072	18"	Sin Rosca	M10 X 1	Ford Grand Marquis 98-99, Lincoln Town Car 01-06 Tras. Izq.
381073	BH381073	20.5"	M10 X 1.5	M10 X 1	Ford Grand Marquis 98-99. Lincoln Town Car 97-00 Tras. Der.
381096	BH381096	16.31"	Sin Rosca	M10 X 1 Int	Chevrolet Luv 98-01 Nacional, Isuzu Rodeo 98-01 Del Izq Der USA
381099	BH381099	17.94"	Sin Rosca	M10 X 1 Int	Honda Tras Der Accord L4 98-02, Accord V6 98-02 (F. Disco)
381100	BH381100	17.94"	Sin Rosca	M10 X 1 Int	Honda Tras Izq. Accord L4 98-02, Accord V6 98-02, (F. Disco)
381102	BH381102	12.19"	3/8 X 24	Sin Rosca	Chevrolet Del Izq-Der Blazer 98-99.
381103	BH381103	6.58"	M10 X 1	M10 X 1	Audi TT 01-05 Tras , Volkswagen. Tras Der - Izq (F. Disco) Golf Cabrio A4 00-01, Golf Cabrio A3 (F. Tambor) 96-99, Tras Jetta A3 CL, GL, (F. Tambor) 93-06, Tras Jetta GLS y Europa A3 (F. Tambor y Disco) 93-95, Jetta VR6 A3 Tras Izq. (F. Disco) 96-98; Tras Izq. Golf GTI A3 (F. Disco) 92-98; Tras Izq. Golf A3 GTI VR6 (F. Disco) 96-98, Golf A4 Europa 03-06, Golf A4 Trendline 03-05, Golf A4 Confortline 03-05, GTI 00-05 , Jetta A4 Highline 03, Jetta A4 GLI 05, Jetta A4 Summer Edition 05, Jetta A4 Edition Limited 05, Jetta A4 Special Edition 05, Beetle 98-06, Derby 96-04
381108	BH381108	21.13"	(2) M10 X 1 Int	M10 X 1 Int	Nissan Frontier 4L 00-04 Tras.
381116	BH381116	12.75"	M10 X 1 Int	M10 X 1 Int	Audi A4 97-02, Audi A6 98-04, Audi S4 00-01 Volkswagen Del Izq-Der Passat 99-05
381119	BH381119	10.47"	Sin Rosca	3/8 X 24 Int	Ford Expedition, Expedition Eddie Bauer 97-99 Tras. Der.
381120	BH381120	15.48"	Sin Rosca	M10 X 1 Int	Nissan Frontier 3.3 Lts 4X4 01-04, X terra 00-04 Del. Der
381121	BH381121	15.48"	Sin Rosca	M10 X 1 Int	Nissan Frontier 3.3 Lts 4X4 01-04, X terra 00-04 Del. Izq.
381133	BH381133	11.15"	Sin Rosca	M10 X 1	Ford Del Izq Grand Marquis S/Control de Tracción 98-02.
381134	BH381134	16.35"	Sin Rosca	3/8 X 24 Int	Ford Del Izq Ranger 4X2 98-11

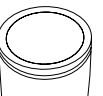



No. PARTE LUSAC	No. PARTE RAYBESTOS	LARGO	MEDIDA DE CUERDA DE CONECTORES		APLICACIÓN
381135	BH381135	16.35"	Sin Rosca	3/8 X 24 Int	Ford Del Der Ranger 4X2 98-11
381136	BH381136	10.88"	M10 X 1 Ext	M10 X 1 Int	Saab 9-3 01-05, Del. Izq. (D-D)
381141	BH381141	11.15"	Sin Rosca	M10 X 1 Int	Ford Del. Der. Grand Marquis S/Control de Tracción 98-02. Del- Der. Lincoln Town Car Del. Izq 01-04S/Control de Tracción. Del. Izq-Der Grand Marquis C/Control de Tracción 00-02.
381142	BH381142	8.1"	Sin Rosca	3/8 X 24 Int	Jeep Grand Cherokee 99-05 Del Der
381143	BH381143	8.1"	Sin Rosca	3/8 X 24 Int	Jeep Grand Cherokee 99-05 Del Izq
381144	BH381144	11.16"	Sin Rosca	M10 X 1 Int	Ford Del Der Grand Marquis S/Control de Tracción 01-02.
381157	BH381157	11"	Sin Rosca	3/8 X 24	Ford Del Der Explorer XLS V6, XLT V8, Limited sin Control de Velocidad 98-02, Ford Ranger 4X4ABS 98-02
381158	BH381158	11"	Sin Rosca	3/8 X 24	Ford Del Izq Explorer XLS V6, XLT V8, Limited sin Control de Velocidad 98-02, Ford Ranger 4X4ABS 98-02
381160	BH381160	18.75"	Sin Rosca	M10 X 1	Chrysler Del Der Dodge Ram Van y Ran Wagon 1500 98-03, Ram Van y Ram Wagon 2500 98-02, Ram Van y Ram Wagon 3500 02
381161	BH381161	18.75"	Sin Rosca	M10 X 1	Chrysler Del Izq Dodge Ram Van y Ran Wagon 1500 98-03, Ram Van y Ram Wagon 2500 98-02, Ram Van y Ram Wagon 3500 02
381163	BH381163	16.89"	3/8 X 24	(2) 7/16 X 24	Ford F-250 97-06 Del. Izq Der; Excursion 2x4 01-05 Del. Izq Der.
381164	BH381164	20.83"	3/8 X 24	(2) 7/16 X 24	Ford Excursion 4x4 01-05 Tras Izq Der.
381165	BH381165	16"	3/8 X 24	(2) 7/16 X 24	Ford F-350 Super Duty 99-04 Del Izq. Der.
381166	BH381166	17.37"	3/8 X 24	(2) 7/16 X 24	Ford F- 550 V10 Super Duty 01-04 Tras Izq
381167	BH381167	18.35"	3/8 X 24	(2) 7/16 X 24	Ford F-250 99-04; Ford F-350 Super Duty 99-04 Tras Central
381168	BH381168	17.37"	7/16 X 24	7/16 X 24	Ford F- 550 V10, F-550 V8 Diesel Super Duty 01-06; F-450 V10, F-450 V8 Diesel Super Duty 99-06Tras. Izq. Der.
381169	BH381169	20.81"	Sin Rosca	M12 X 1	Ford Del Der Excursión 4X2 01-05, F-250 99-04, F-350 99-04, F-350 Super Duty 99-04.
381170	BH381170	20.81"	Sin Rosca	3/8 X 24	Ford Del Izq Excursión 4X2 01-05, F-250 99-04 F-350 99-04, F-350 Super Duty 99-04.
381184	BH381184	17.98"	Sin Rosca	3/8 X 24	Ford F-250 99-04 Del Izq, F-350 Super Duty Triton 99-04 Del Izq
381185	BH381185	25"	Sin Rosca	3/8 X 24	Ford F-250 99-04; Ford F-350 Super Duty 99-04 Del Izq 4X4 con ABS a las 4 ruedas
381186	BH381186	17.98"	Sin Rosca	3/8 X 24	Ford F-250 99-04 Del Der, F-350 Super Duty Triton 99-04 Del Der
381187	BH381187	19.98"	Sin Rosca	3/8 X 24	Ford Del Der Excursión 4 X 4 01-05, F250 Super Duty 99-04, F350 Super Duty 99-04 4X4.
381188	BH381188	19.98"	Sin Rosca	3/8 X 24	Ford Del Izq Excursión 4 X 4 01-05, F250 Super Duty 99-04, F350 Super Duty 99-04 4X4.
381189	BH381189	19.98"	Sin Rosca	3/8 X 24	Ford F-250 99-04; Ford F-350 Super Duty 99-04 Del Izq 4X4 con ABS a las ruedas traseras
381218	BH381218	20.09"	3/8 X 24	(2) 3/8 X 24	Chrysler Dodge Dakota 87 Tras USA
381248	BH381248	10.89"	M10 X 1	M10 X 1	Honda Odyssey 00-04 Tras.
381261	BH381261	17.75"	Sin Rosca	M10 X 1	Honda Del Izq-Der Odyssey 00-07, Pilot 03-08
381262	BH381262	26"	Sin Rosca	3/8 X 24	Ford Del Der F-450 V-10, F-450 V8 Diesel, Super Duty 99-06, F-550 V-10 F-450 V8 Diesel, SuperDuty 01-06.
381263	BH381263	26"	Sin Rosca	3/8 X 24	Ford Del Izq F-450 V-10, F-450 V8 Diesel, Super Duty 99-06, F-550 V-10 F-450 V8 Diesel, SuperDuty 01-06.
381264	BH381264	9.68"	M10 X 1	M10 X 1	BMW Z3 96-97 Tras
381271	BH381271	10.88"	Sin Rosca	M10 X 1	Chevrolet Grand Prix GT, GTP, SE 99-01 Del. Izq. Der; Impala 00-04 Del. Izq. Der.
381272	BH381272	22.5"	7/16 X 24	(2) 3/8 X 24	Chevrolet Avalanche 03, Cheyenne 02-07, Silverado 1500 99-06, Silverado 2500 99-06, C-3500 HDV8 7.5L 01-04 Tras
381273	BH381273	14.25"	Sin Rosca	3/8 X 24	Chevrolet Silverado 1500 2x2 y 2x4 00-06, Silverado 2500 2x2 y 2x4 00-06, Silverado 3500 2x2 y 4x4 96-05 Tras. Izq.
381276	BH381276	16"	Sin Rosca	3/8 X 24	Chevrolet Avalanche 02-06, Chevrolet Cheyenne Crew Cab 4X2 07, Cheyenne Crew Cab 4X4 07 TrasDer
381280	BH381280	10.63"	3/8 X 24	3/8 X 24	Ford F-250 03-04, F-350 Heavy Duty 99-04 Del Izq
381281	BH381281	12.25"	M10 X 1 Int	Sin Rosca	Ford Del Der Windstar LX, Se Sel Limited. 99-03.
381282	BH381282	19.72"	Sin Rosca	Sin Rosca	Chrysler Manguera Central Dodge Ram 2500 98-99
381283	BH381283	13.5"	Sin Rosca	M10 X 1	Ford Mustang GT 99-04 Tras Izq
381284	BH381284	13.5"	Sin Rosca	M10 X 1	Ford Mustang GT 99-04 Tras Der
381285	BH381285	24.9"	Sin Rosca	M10 X 1	Ford Grand Marquis 00-04, F150 89-91 Tras Der

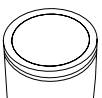



Buyers Guides



No. PARTE LUSAC	No. PARTE RAYBESTOS	LARGO	MEDIDA DE CUERDA DE CONECTORES		APLICACIÓN
381286	BH381286	24.9"	Sin Rosca	3/8 X 24	Ford Del Der Mustang GT 99-04.
381287	BH381287	24.37"	Sin Rosca	7/16 X 24	Ford Del Izq Mustang GT 99-04.
381292	BH381292	9.95"	Sin Rosca	M10 X 1	Toyota Landcruiser 04-07 Tras Izq
381295	BH381295	15.85"	Sin Rosca	M10 X 1	Toyota Land Cruisier 04-07 Del Der
381296	BH381296	15.85"	Sin Rosca	M10 X 1	Toyota Land Cruisier 04-07 Del Izq
381298	BH381298	28.15"	Sin Rosca	7/16 X 24	Chevrolet Silverado 1500 00-06, Silverado 2500 01-06 Silverado 3500 96-06, Chevrolet Cheyenne V85.3L 4X2 06 Del Izq
381299	BH381299	28.15"	Sin Rosca	7/16 X 24	Chevrolet Silverado 1500 00-06, Silverado 2500 01-06 Silverado 3500 96-06, Chevrolet Cheyenne4X2 06 Del Der
381302	BH381302	10.31"	M10 X 1 Int	Sin Rosca	Ford Del Izq Windstar LX, Se Sel Limited. 99-03.
381303	BH381303	14.13"	Sin Rosca	M10 X 1	Ford Lincoln LS 00-06 Tras Izq
381305	BH381305	18"	Sin Rosca	M10 X 1	Ford Del Der Lincoln LS 00-06.
381307	BH381307	17.13"	Sin Rosca	3/8 X 24	Ford Econoline E-150 07,Econoline E-350 99-14, Club Wagon V8 E-350 XL 99-02 Econoline ClubWagon V8 E-350 01-04 Tras Izq
381308	BH381308	21.42"	Sin Rosca	M10 X 1	Ford Mustang 99-04 Tras Der
381310	BH381310	13.07"	Sin Rosca	M10 X 1	Ford Lincoln Town Car 98-05 Tras Der
381311	BH381311	13.07"	Sin Rosca	M10 X 1	Ford Lincoln Town Car 98-05 Tras Izq
381312	BH381312	16.73"	Sin Rosca	3/8 X 24	Ford Ranger 98-99 Tras Frenos ABS a las 4 ruedas
381314	BH381314	26.63"	7/16 X 24	7/16 X 24	Chevrolet C-60 Series 93-99, C-70 Series 91-00, GMC 60 Series 96-00, GMC 70 Series 96-00 TrasIzq
381315	BH381315	32"	7/16 X 24	7/16 X 24	Chevrolet C-60 Series 93-99, C-70 Series 91-00, GMC 60 Series 96-00, GMC 70 Series 96-00 TrasDer
381319	BH381319	35.22"	7/16 X 24	7/8 X 14	Chevrolet C-60 Series 93-99, C-70 Series 91-00 Del
381332	BH381332	25.75"	3/8 X 24	3/8 X 24	Ford Ranger 98-99 Tras Der Frenos ABS ruedas traseras
381338	BH381338	19.5"	Sin Rosca	Sin Rosca	Ford Del Izq F-150 4X2 ABS en ruedas traseras 99-04, Lobo 01-04. F-250 00-02, Expedition XLT,Eddie Bauer 00-02. Lincoln Navigator 98-02, Lincoln Blackwood Izq-Der 03
381339	BH381339	20.46"	Sin Rosca	Sin Rosca	Chrysler Del Der Dodge Ram 1500 4X2 Con ABS atrás 94-01, Ram 2500 00-01, Ram 3500 00-02,Ram 4000 00-01, Ram Charger 00-01
381340	BH381340	18.12"	Sin Rosca	3/8 X 24	Chrysler Del Izq Dodge Ram 1500 4X2 Con ABS Atrás 94-01, Ram 2500 00-01, Ram 3500 00-02,Ram 4000 00-01, Ram Charger 00-01
381342	BH381342	12.45"	7/16 X 24	Sin Rosca	Chevrolet Blazer 00-01 Del Izq Der
381343	BH381343	19.45"	7/16 X 24	Sin Rosca	Chevrolet Blazer 00-01, S-10 Pick Up 00-03 Del Der
381344	BH381344	19.12"	7/16 X 24	Sin Rosca	Chevrolet Blazer 00-01, S-10 Pick Up 00-03 Del Izq
381345	BH381345	12.37"	7/16 X 24	Sin Rosca	Chevrolet Del Izq Der S-10 Pick Up 00-04.
381349	BH381349	10.85"	M10 X 1	M10 X 1	Subaru Legacy, Legacy GT 06-10 Tras
381350	BH381350	21.35"	Sin Rosca	M10 X 1	Subaru Outback 06-10, Forester 07-08 Del Der
381351	BH381351	19.75"	Sin Rosca	M10 X 1	Subaru Legacy 06-10, Legacy GT 06-10 Del. Der.
381352	BH381352	21.35"	Sin Rosca	M10 X 1	Subaru Outback 06-10 Del. Izq.
381353	BH381353	19.75"	Sin Rosca	M10 X 1	Subaru Legacy 06-10, Legacy GT 06-10 Del. Izq.
381354	BH381354	22.06"	Sin Rosca	3/8 X 24 Int	Chrysler Dodge Del Der Ram 1500 00-01, Ram 2500HD 00-02,Ram 3500 00-02
381355	BH381355	21"	Sin Rosca	3/8 X 24 Int	Chrysler Dodge Del Izq Ram 1500 00-01, Ram 2500HD 00-02,Ram 3500 00-02
381360	BH381360	21.42"	M10 X 1	M10 X 1	Chrysler Dodge Durango 99-04 Tras
381363	BH381363	7.25" & 9.75"	Sin Rosca	M10 X 1	Chrysler Dodge Durango 00-02 Del Der
381364	BH381364	7.25" & 10"	Sin Rosca	M10 X 1	Chrysler Dodge Durango 00-02 Del Izq
381365	BH381365	18.85"	Sin Rosca	3/8 X 24	Ford Lincoln Navigator 01-02 Expedition XL, Eddie Bauer 00-01, F-150 4X4 ABS 99-04 Del Izq
381367	BH381367	22.13"	3/8 X 24	3/8 X 24	Chrysler Dodge Ram 1500 00-01, Ram 2500 00-01, Ram-2500 Quad Cab 00, Ram 3500 00-01, Ram4000 00-01, Ram Charger 00-01 Tras
381369	BH381369	8.95"	M10 X 1	M10 X 1	Ford Focus STV 00-04, Focus LX, SE, ZTS, Wagon 00-08, Focus ZX3 00-04 Tras Izq Der
381376	BH381376	14.1"	Sin Rosca	M10 X 1	Ford Focus STV 02-06, Focus LX, SE, ZTS, Wagon 00-06, Focus ZX3 00-05 Del Izq Der
381377	BH381377	14.05"	M10 X 1	M10 X 1	Nissan Quest XE 99-02 Tras
381378	BH381378	18.23"	3/8 X 24	3/8 X 24	Chrysler Tras Der Dodge Neon 00-05, Neon SRT-4 04-05
381379	BH381379	18.23"	3/8 X 24	3/8 X 24	Chrysler Tras Izq Dodge Neon 00-05, Neon SRT-4 04-05





No. PARTE LUSAC	No. PARTE RAYBESTOS	LARGO	MEDIDA DE CUERDA DE CONECTORES		APLICACIÓN
381380	BH381380	16.05"	7/16 X 24	Sin Rosca	Chevrolet Sonora 00 02 Trasera Izq Der, Suburban 1500 00-02 Tras central
381381	BH381381	16.2"	7/16 X 24	Sin Rosca	Chevrolet Avalanche 02 Tras
381382	BH381382	18.75"	M10 X 1 Int	Sin Rosca	Chevrolet Cadillac Seville 96, 00-01 y 03-04, Cadillac Deville 00-04, Del IZQ
381383	BH381383	18.75"	M10 X 1	Sin Rosca	Chevrolet Cadillac Seville 96, 00-01 y 03-04, Cadillac Deville 00-04, Del Der
381388	BH381388	11.6"	Sin Rosca	M10 X 1	Subaru Legacy GT 06-10 Tras. Exterior
381389	BH381389	16.35"	Sin Rosca	M10 X 1	Volkswagen Del Izq-Der Passat VR6 2.8 Lts. 96-97, Passat Vagoneta VR6 96-97.
381390	BH381390	13.9"	Sin Rosca	M10 X 1	Ford Mustang GT 99-04 Tras Izq
381454	BH381454	13.25"	Sin Rosca	M10 X 1	Chevrolet Del Izq Silverado 1500 02, C-1500, C-2500 01-03.
381455	BH381455	10.55"	M10 X 1	M10 X 1	Toyota Corolla CE, Corolla LE 03-08, Matrix XR 03-08, Matrix XR S 04-05, Corolla S 05-08 Tras.
381458	BH381458	8.15"	7/16 X 24	7/16 X 24	Chevrolet Tras Izq-Der Pontiac Aztek 01-05.
381466	BH381466	21.88"	Sin Rosca	M10 X 1	Honda Civic Sedan 01-02, Civic Sedan 03-06 Del. Der.
381467	BH381467	21.88"	Sin Rosca	M10 X 1	Honda Civic Sedan 01-02, Civic Sedan 03-06 Del. Izq.
381468	BH381468	15.75"	M10 X 1	M10 X 1	Toyota Camry LE 02-06, Camry XLE 04-06 Tras. Der.
381469	BH381469	15.75"	M10 X 1	M10 X 1	Toyota Camry LE 02-06, Camry XLE 04-06 Tras. Izq.
381475	BH381475	22.13"	3/8 X 24	(2) M11 X 1.5	Chrysler Dodge Ram 1500 02-06, Ram 2500 Quad Cab 01-02, Ram 3500 02-06, Tras
381499	BH381499	12.13"	M10 X 1	M10 X 1	Acura TL 05-08 Del Izq Der, Honda Accord 03-05, Civic 01-06, Fit 06-08 Tras Izq Der
381501	BH381501	11.25"	M10 X 1	M10 X 1	Mitsubishi Lancer LS, LS Diamond, ES DS 04-07, Outlander 04-08 Tras Izq Der
381502	BH381502	13.05"	M10 X 1	M10 X 1	Audi A4 01-09, Audi S4 04-09 Del Izq Der
381503	BH381503	7.82"	M10 X 1	M10 X 1	Audi A6 98-06, A6 Quattro 98-06, S6 01-04, Volkswagen Passat 02-05 Tra Izq Der
381510	BH381510	12.13"	M10 X 1	M10 X 1	BMW 525i 01-03 Tras
381513	BH381513	25.37"	M10 X 1	(2) M11 X 1.5	Chryslers Dodge Ram 1500 02 Tras
381514	BH381514	25.67"	M12 X 1	M10 X 1.25	Chrysler Dodge Ram 2500 03-05, Ram-2500 Quad Cab 03-04 Tras Izq Der
381534	BH381534	13.63"	1/2 X 20 Int	Sin Rosca	Chevrolet Aztek 01-05 Del Izq Der
381544	BH381544	17.62"	Sin Rosca	M10 X 1	Acura TL 07-08, Honda Accord Motor 4L 03-07, Accord Motor V6 03-07 Del Der
381545	BH381545	17.62"	Sin Rosca	M10 X 1	Acura TL 07-08, Honda Accord Motor 4L 03-07, Accord Motor V6 03-07 Del Izq
381546	BH381546	18.62"	Sin Rosca	M10 X 1	Honda Accord Motor 4L 03-07, Accord Motor V6 03-07 Tras Der
381547	BH381547	18.62"	Sin Rosca	M10 X 1	Honda Accord Motor 4L 03-07, Accord Motor V6 03-07 Tras Izq
381550	BH381550	17.12"	Sin Rosca	M10 X 1	Acura TL 05-08 Tras Der
381551	BH381551	17.12"	Sin Rosca	M10 X 1	Acura TL 05-08 Tras Izq
381554	BH381554	17.62"	Sin Rosca	Sin Rosca	Honda Civic 4 Ptas 03-05 Del Der
381555	BH381555	23.13"	M10 X 1 Int	Sin Rosca	Honda Civic 4 Ptas 03-05 Del Izq
381556	BH381556	23"	M10 X 1 Int	Sin Rosca	Honda:Civic EX 2 Ptas 01-05 Del Der
381557	BH381557	23"	M10 X 1 Int	Sin Rosca	Honda:Civic EX Ptas 01-05 Del Izq
381566	BH381566	18.62"	Sin Rosca	M10 X 1	Honda Civic Coupe 03-05, Civic Sedan 03-05 Tras Der.
381567	BH381567	18.62"	Sin Rosca	M10 X 1	Honda Civic Coupe 03-05, Civic Sedan 03-05 Tras Izq.
381580	BH381580	13.28"	M10 X 1	M10 X 1	Nissan Sentra 1.8 Lts 02-06, Sentra GXE 02-06 Tras Der
381581	BH381581	13.28"	Sin Rosca	M10 X 1	Nissan Sentra 1.8 Lts 02-06, Sentra GXE 02-06 Tras Izq
381586	BH381586	14.45"	M10 X 1	M10 X 1	Acura MDX 05-06 Tras Der, Honda Pilot 03-08 Tras Izq Der
381587	BH381587	6.55"	Sin Rosca	3/8 X 24	Acura MDX 05-06 Tras Izq
381588	BH381588	23.25"	Sin Rosca	M10 X 1	Nissan Infiniti I-35 02-05, Maxima 02-03 Tras Der
381589	BH381589	24.38"	M10 X 1 Int	Sin Rosca	Nissan Infiniti I-35 02-05, Maxima 02-03 Tras Izq
381591	BH381591	19.5"	M10 X 1 Int	Sin Rosca	Nissan Sentra 1.8 Lts 02-06 Sentra 2.5 Lts 02-06 Del Der
381592	BH381592	21.5"	Sin Rosca	M10 X 1	Nissan Sentra SE-R 2.5 Lts 02-06 Tras Der
381594	BH381594	20.5"	Sin Rosca	M10 X 1	Nissan Altima Sedan S, Altima Sedan SL, Altima Sedan SE 02-06, Maxima SE 04-08 Del. Der.
381607	BH381607	9.35"	M10 X 1	M10 X 1	Toyota Sienna 04-06 Central
381610	BH381610	15.12"	Sin Rosca	M10 X 1	Toyota MR2 Spider 05-06 Del Der
381612	BH381612	14"	M10 X 1	M10 X 1	Toyota Landcruiser 04-07 Central
381613	BH381613	11.25"	M10 X 1	M10 X 1	Toyota 4 Runner 03-09, FJ Cruiser 08-13 Del Izq Der



Buyers Guides



No. PARTE LUSAC	No. PARTE RAYBESTOS	LARGO	MEDIDA DE CUERDA DE CONECTORES		APLICACIÓN
381614	BH381614	12.88"	M10 X 1	M10 X 1	Toyota 4 Runner 03-09, FJ Cruiser 08-12 Central
381621	BH381621	9"	M10 X 1	M10 X 1	Chevrolet Aveo 08-14, Pontiac G3 06-09 Tras Izq Der
381622	BH381622	8.92"	Sin Rosca	M10 X 1	Chevrolet Tracker 01-02 Central
381624	BH381624	12.75"	Sin Rosca	M10 X 1	Chevrolet Silverado 3500 Heavy Duty 96-06, Chevrolet C-3500 HD 01-06 Tras Izq
381634	BH381634	9.7"	M10 X 1	M10 X 1	Chevrolet HHR 06-09, Pontiac G5 07-09 Tras
381639	BH381639	10.87"	M10 X 1	M10 X 1	Chevrolet Pontiac Torrent 06-09 Tras Izq
381640	BH381640	10.87"	M10 X 1	M10 X 1	Chevrolet Pontiac Torrent 06-09 Tras Der
381643	BH381643	20.63"	3/8 X 24	(2) 3/8 X 24	Ford Explorer Sport Trac 01-02 Tras Izq Der Disco Tambor
381646	BH381646	18.5"	M10 X 1 Int	Sin Rosca	Toyota: Camry 02-06, Solara 05-06 Del Der Nacional, Lexus: ES330 05-06 USA Del Der
381647	BH381647	18.75"	Sin Rosca	M10 X 1 Int	Toyota Camry XLE 02-06; Solara 05-06 Del Izq
381649	BH381649	23.12"	Sin Rosca	M10 X 1 Int	Toyota Camry XLE 02-07; Solara 05-06 Tras Izq
381650	BH381650	13.25"	M10 X 1 Int	M10 X 1 Int	Nissan 350Z 03-08, Infiniti G35 05 Tras Der
381651	BH381651	13.25"	M10 X 1 Int	M10 X 1 Int	Nissan 350Z 03-08, Infiniti G35 05 Tras Izq
381652	BH381652	16.25"	M10 X 1 Int	M10 X 1 Int	Nissan Pathfinder 03 Tras
381653	BH381653	20.25"	M10 X 1 Int	M10 X 1 Int	Nissan Frontier 03; Titan 04-05; Xterra 02-04 Tras Der
381658	BH381658	16.38"	M10 X 1 Int	M10 X 1 Ext	Chrysler Crossfire 04-06 Del Izq der, Mercedes Benz C300 10-11, C350 06-14, CLK320 98-05, CLK350 06-09, CLK500 03-06, E350 10-13, SLK500 03-05, CLK55 AMG 04-05, CLK63 AMG 08-09, SLK280 07-08, SLK350 05-14, SLK55 08-14 Del Izq der
381661	BH381661	12.13"	M10 X 1 Int	M10 X 1 Ext	Chrysler Crossfire 04-06 Tras Izq der
381673	BH381673	24.31"	Sin Rosca	M10 X 1 Int	Toyota Corolla S 05-08, Matrix XR S 03-06 Del Der
382300	BH382300	27.1"	7/16 X 24	Sin Rosca	Ford F150 02-03, F150 Heritage 04 Tras Izq
382302	BH382302	18"	M10 X 1 Int	Sin Rosca	Nissan Frontier 3.3 Lts 01-04, X-terra 00-04 Del Izq
382304	BH382304	43"	3/8 X 24	3/8 X 24 ySin rosca	Chrysler Dodge Ram 1500 00-01, Ram 2500HD 00-01, Ram 3500 00-01 Del Izq
382305	BH382305	39"	3/8 X 24 Int	Sin Rosca	Chrysler Dodge Ram 1500 00-01, Ram 2500HD 00-01, Ram 3500 00-01 Del Der
382306	BH382306	17.5"	3/8 X 24 Int	Sin Rosca	Chrysler PT Cruiser 01-10 Del Izq Sin ABS
382307	BH382307	17.5"	3/8 X 24 Int	Sin Rosca	Chrysler PT Cruiser 01-10 Del Der Sin ABS
382308	BH382308	19.38"	M10 X 1 Int	Sin Rosca	Chrysler 300 10 y 12, 300C 5.7 Lts 05-10, Charger 06-10 Nacional, 300 05, Magnum 05 Del Izq Der
382309	BH382309	22.5"	M10 X 1 Int	Sin Rosca	Jeep:Liberty 02-07 Del Der
382310	BH382310	22.45"	M10 X 1 Int	Sin Rosca	Jeep: Liberty 02-07 Del Izq
382311	BH382311	17.71"	M10 X 1 (3) Int	Sin Rosca	Jeep Liberty 02-06 Tras Central
382312	BH382312	17.75"	3/8 X 24 Int	Sin Rosca	Chrysler PT Cruiser 01-10 Del Der Con ABS
382313	BH382313	17.75"	3/8 X 24 Int	Sin Rosca	Chrysler PT Cruiser 01-10 Del Izq Con ABS
382314	BH382314	9.86"	3/8 X 24	3/8 X 24	Chrysler PT Cruiser 01-03 Tras Der Sin ABS
382315	BH382315	14.32"	3/8 X 24 Int	Sin Rosca	Chrysler PT Cruiser 01-10 Tras Der Con ABS
382316	BH382316	11.32"	3/8 X 24 Int	Sin Rosca	Chrysler PT Cruiser 01-10 Tras Izq Con ABS
382317	BH382317	9.86"	3/8 X 24	3/8 X 24	Chrysler PT Cruiser 01-03 Tras Izq Sin ABS
382319	BH382319	25"	3/8 X 24 Int	Sin Rosca	Chevrolet G-30 Express cargo van 3500 97-03, Express 3500 97-03, Express 3500 EXT 97-03, Express van 3500 8 pasajeros 03 Del Izq Nacional, Chevrolet ,Savana 3500 96-02, Savana 3500 EXT 96-02 USA Del Izq
382320	BH382320	24.75"	3/8 X 24 Int	Sin Rosca	Chevrolet G-30 Express cargo van 3500 97-03, Express 3500 97-03, Express 3500 EXT 97-03, Express van 3500 8 pasajeros 03 Del Der Nacional, Chevrolet Savana 3500 96-02, Savana 3500 EXT 96-02 USA Del Der
382321	BH382321	43"	3/8 X 24 Int	Sin Rosca	Jeep:Grand Cherokee 99-04 Del Der
382322	BH382322	43"	3/8 X 24 Int	Sin Rosca	Jeep:Grand Cherokee 99-04 Del Izq
382323	BH382323	43.25"	3/8 X 24 Int	Sin Rosca	Chrysler Dodge Ram 1500 4X4 Con ABS 00-01, Ram 2500HD 00-02, Ram 3500 00-02 Del Der
382324	BH382324	42.0"	3/8 X 24 Int	Sin Rosca	Chrysler Dodge Ram 1500 4X4 Con ABS 00-01, Ram 2500HD 00-02, Ram 3500 00-02 Del Izq
382325	BH382325	18.5"	3/8 X 24 Int	Sin Rosca	Chrysler: Neon 00-05 Del Der
382326	BH382326	18.5"	3/8 X 24 Int	Sin Rosca	Chrysler: Neon 00-05 Del Izq
382327	BH382327	21.38"	3/8 X 24 Int	Sin Rosca	Chrysler: Neon 00-05, Neon SRT-4 03-05 Tras Der
382328	BH382328	21.38"	3/8 X 24 Int	Sin Rosca	Chrysler: Neon 00-05, Neon SRT-4 03-05 Tras Izq





No. PARTE LUSAC	No. PARTE RAYBESTOS	LARGO	MEDIDA DE CUERDA DE CONECTORES		APLICACIÓN
382329	BH382329	21.5"	M10 X 1 Int	Sin Rosca	Ford Mustang 05-14 Del Izq Con ABS
382330	BH382330	21"	M10 X 1 Int	Sin Rosca	Ford Mustang 05-14 Del Der Con ABS
382331	BH382331	21"	M10 X 1 (2) Int	Sin Rosca	Ford Mustang 05-08 Del Izq Sin ABS
382332	BH382332	21.5"	M10 X 1 Int	Sin Rosca	Ford Mustang 05-08 Del Der Sin ABS
382333	BH382333	12.38"	M10 X 1 Int	Sin Rosca	Ford Mustang 05-14 Tras Der Con ABS
382334	BH382334	12.38"	M10 X 1 Int	Sin Rosca	Ford Mustang 05-14 Tras Izq Con ABS
382335	BH382335	12.38"	M10 X 1 Int	Sin Rosca	Ford Mustang 06-10 Tras Der Sin ABS
382336	BH382336	12.38"	M10 X 1 (2) Int	Sin Rosca	Ford Mustang 06-10 Tras Izq Sin ABS
382337	BH382337	13.38"	M10 X 1 Int	Sin Rosca	Chevrolet Malibu 02-04 Del Izq
382338	BH382338	13.38"	M10 X 1	Sin Rosca	Chevrolet Malibu 02-04 Del Der
382339	BH382339	55.5"	3/8 X 24	Sin Rosca	Chrysler Town & Country 01-07 Tras Izq Nacional, Chrysler Dodge Caravan 03 USA Tras Izq
382342	BH382342	37.38"	3/8 X 24 Int	Sin Rosca	Chrysler Town & Country 05-06 Tras Der D/D Nacional, Chrysler Dodge Grand Caravan 05-06 TrasDer D/D USA
382344	BH382344	37.38"	3/8 X 24 Int	Sin Rosca	Chrysler Town & Country 05-06 Tras Izq D/D Nacional, Chrysler Dodge Grand Caravan 05-06 TrasIzq D/D USA
382345	BH382345	55.5"	3/8 X 24	Sin Rosca	Chrysler Town & Country 01-02 Tras Izq Nacional, Chrysler Dodge: Caravan 01-02 USA Tras Izq
382346	BH382346	33.5"	3/8 X 24 Int	Sin Rosca	Chrysler Town & Country 03-06 Tras Izq D/T
382347	BH382347	37"	3/8 X 24 Int	Sin Rosca	Chrysler Town & Country 01-07 Tras Der D/D Nacional, Chrysler Dodge Caravan 03 USA Tras Der/D
382348	BH382348	37"	3/8 X 24 Int	Sin Rosca	Chrysler Grand Voyager 01-02, Town & Country 01-07, Voyager 01-03 Tras Der D/T
382350	BH382350	35.5"	3/8 X 24 Int	Sin Rosca	Chrysler Grand Voyager 01-02, Town & Country 01-04 Tras Der
382351	BH382351	14.75"	3/8 X 24	M10 X 1	Chrysler: Stratus 03-06, Sebring 03-06 Tambor Trasero Tras Der
382352	BH382352	14.75"	3/8 X 24	M10 X 1	Chrysler: Stratus 03-06, Sebring 03-06 Tambor Trasero Tras Izq
382354	BH382354	23"	M10 X 1 (3) Int	Sin Rosca	Chrysler Dodge Ram 1500 00-01, Ram 2500HD 00-02, Ram 3500 00-02, Dakota 05-10 Tras Central
382355	BH382355	18.13"	Sin Rosca	M10 X 1 Int	Chrysler 300 3.6 Lts y 5.7 Lts Traccion Trasera 10 y 12-14, 300C 5.7 Lts 05-12, Challenger 3.6 y 5.7Lts 11-14, Charger 3.6 y 5.7 Lts 10-14 Tras Izq Tracc Trasera
382356	BH382356	19.13"	M10 X 1 Int	Sin Rosca	Chrysler 300 12-14, 300C 05-12, Charger 06-14 Tras Izq Tracc a las 4 Ruedas
382358	BH382358	19.13"	M10 X 1 Int	Sin Rosca	Chrysler 300C 05-12, Charger 06-10 Tras Der Trac a las 4 ruedas
382360	BH382360	17.38"	M10 X 1 Int	Sin Rosca	Chrysler :300C SRT-8 6.1 Lts06-08, Charger SRT-8 06-10, Charger R/T Daytona 07-10 Tras Der
382361	BH382361	17.38"	M10 X 1 Int	Sin Rosca	Chrysler :300C SRT-8 6.1 Lts 06-08, Charger SRT-8 06-10, Charger R/T Daytona 07-10 Tras Izq
382362	BH382362	19.62"	3/8 X 24 Int	Sin Rosca	Chrysler Dodge: Pacifica 05-08 Tras Izq
382363	BH382363	22"	M10 X 1 Int	Sin Rosca	Chrysler Dodge Aspen 07-09, Durango 05-09 Tras Izq Der
382364	BH382364	20.38"	M12 X 1 Int	Sin Rosca	Chrysler Dodge: Ram 1500 4X2 06-09, Ram 2500 4X4 Heavy Duty 03-14, Del Der
382365	BH382365	19.38"	Sin Rosca	M10 X 1	Toyota:Camry 07-11 Del Der Nacional, Toyota Avalon 05-09 USA Del Der
382366	BH382366	25.5"	3/8 X 24 Int	Sin Rosca	Chrysler Town & Country 01-07, Voyager 01-08 Del Der Nacional, Chrysler Dodge Grand Caravan01-07 USA Del Der
382367	BH382367	25.5"	3/8 X 24 Int	Sin Rosca	Chrysler Town & Country 01-07, Voyager 01-08 Del Izq Nacional, Chrysler Dodge Grand Caravan 01-07 USA Del Izq
382368	BH382368	18.75"	3/8 X 24 Int	Sin Rosca	Chrysler Dodge: Pacifica 05-08 Tras Der
382371	BH382371	25.81"	M10 X 1 Int	Sin Rosca	Chrysler Charger 06-10 Del Der Nacional, Chrysler: Challenger 09-10, Magnum 05-08 USA DelDer
382372	BH382372	25.25"	M10 X 1 Int	Sin Rosca	Chrysler 300 10 y 12, 300C 5.7 Lts 05-12, Challenger 5.7 Lts 09-14, Charger 6.4 Lts 06-14 Del DerTracc Tras Nacional, Chrysler: Magnum 05-08 USA Del Der Tracc Tras
382373	BH382373	25.75"	M10 X 1 Int	Sin Rosca	Chrysler 300 SRT-8 V8 6.4 Lts 12-14, 300C SRT-8 6.1 Lts 05-10, Challenger 6.1 y 6.4 Lts 08-14,Charger 6.4 Lts 06-14 Del Izq Nacional, Chrysler: Magnum 06-08 USA Del Izq
382374	BH382374	25.75"	M10 X 1 Int	Sin Rosca	Chrysler Charger 3.5 Lts 06-10 Del Izq Nacional, Chrysler: Challenger 09-10, Magnum 06-08 USA Del Izq

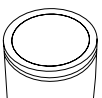



Buyers Guides



No. PARTE LUSAC	No. PARTE RAYBESTOS	LARGO	MEDIDA DE CUERDA DE CONECTORES		APLICACIÓN
382375	BH382375	25.38"	M10 X 1 Int	Sin Rosca	Chrysler 300 10 y 12, 300C 5.7 Lts 05-12, Challenger 5.7 Lts 09-14, Charger 3.5 Lts 06-10 Del IzqTracc Tras Nacional, Chrysler: Magnum 06-08 USA Del Izq Tracc Tras
382376	BH382376	22.13"	M10 X 1 Int	Sin Rosca	Chrysler 300 SRT-8 V8 6.4 Lts 12-14, 300C SRT-8 05-10, Challenger 6.1 y 6.4 Lts 08-14, Charger6.4 Lts 06-14 Del Der Nacional, Chrysler: Magnum 06-08 USA Del Der
382377	BH382377	34.25"	M12 X 1 Int	Sin Rosca	Chrysler Dodge: Ram 1500 4X4 06-09, Ram 2500 4X4 Heavy Duty 03-14, Ram 3500 Heavy Duty 03-08 Del Der
382378	BH382378	33"	M12 X 1 Int	Sin Rosca	Chrysler Dodge: Ram 1500 4X4 06-09, Ram 2500 4X4 Heavy Duty 06-07, Ram 3500 Heavy Duty 06-07 Der Izq
382379	BH382379	20.25"	M12 X 1 Int	Sin Rosca	Chrysler Dodge: Ram 1500 4X2 06-09, Ram 2500 4X2 Heavy Duty 03-12, Ram 3500 Heavy Duty 05-07 Del Izq
382380	BH382380	30.38"	Sin Rosca	M10 X 1 Int	Chrysler Dodge Ram 1500 3.7 Lts 02-05 Del Izq Con ABS ruedas traseras
382381	BH382381	30.38"	Sin Rosca	M10 X 1 Int	Chrysler Dodge Ram 1500 5.7 Lts 04-05 Del Izq Con ABS Ruedas traseras
382383	BH382383	30.38"	Sin Rosca	M12 X 1 Int	Chrysler Dodge Ram 1500 02-05 Del Izq Con ABS a las 4 ruedas
382384	BH382384	21.5"	Sin Rosca	M10 X 1 Int	Ford Expedition 02-06, Lincoln Navigator 02-06 Tras Izq con control de traccion
382385	BH382385	9.38"	M10 X 1 Ext	M10 X 1 Int	Ford: Five Hundred 05-07, Mercury Montego 05-07 Tras Izq Der
382387	BH382387	18.13"	M10 X 1 Int	Sin Rosca	Ford: Mariner 05-07 Tras Der Nacional, Ford: Escape 01-07 USA Tras Der
382388	BH382388	18.25"	M10 X 1 Int	Sin Rosca	Ford: Mariner 05-07 Tras Izq Nacional, Ford: Escape 01-07 USA Tras Izq
382389	BH382389	21.63"	M10 X 1 Int	Sin Rosca	Ford: Five Hundred 05-07, Mercury Montego 05-07 Del Der
382390	BH382390	21.63"	M10 X 1 Int	Sin Rosca	Ford: Five Hundred 05-07, Mercury Montego 05-07 Del Izq
382391	BH382391	15.63"	M10 X 1 Int	Sin Rosca	Ford Focus 05 Del Izq Der
382392	BH382392	8.69"	M10 X 1 (2) Int	Sin Rosca	Ford: Focus 05-07 Tras Der Disco Tambor
382393	BH382393	17.5"	M10 X 1	M10 X 1	Ford: Focus 05-07 Tras Izq Disco disco
382394	BH382394	24"	3/8 X 24 Int	Sin Rosca	Ford: Aviator 03-05 Del Izq
382395	BH382395	24"	3/8 X 24 Int	Sin Rosca	Ford: Aviator 03-05 Del Der
382396	BH382396	16.38"	3/8 X 24 Int	Sin Rosca	Chevrolet Cheyenne 02-07, Silverado 1500 02-04, Silverado 2500 03-04 Tras Izq Nacional,Chevrolet Sierra 1500 03-04 USA Tras Izq
382397	BH382397	19"	3/8 X 24 Int	Sin Rosca	Chevrolet Silverado 1500 02-03 Tras Izq
382399	BH382399	22"	Sin Rosca	3/8 X 24 Int	Chevrolet C-3500 01-06, Silverado 2500 02-04, Silverado 2500HD 02-06, Silverado 3500 01-06,Silverado Classic 2500HD 07, Silverado Classic 3500 07, Suburban 2500 00-06 Tras Der Nacional,Chevrolet Sierra 2500 02-04, Sierra 2500HD 02-06, Sierra 3500 01-06, Sierra Classic 2500HD 07, Sierra Classic 3500 07 USA Tras Der
382405	BH382405	15.38"	M10 X 1 Int	Sin Rosca	Chevrolet Corvette 97-04 Del Izq Der
382406	BH382406	18.5"	3/8 X 24 Int	Sin Rosca	Chevrolet Silverado 1500 00-01 Tras Der Nacional, Chevrolet Sierra 1500 01, USA Tras Der
382412	BH382412	28.38"	7/16 X 24 Int	Sin Rosca	Cadillac Escalade 02-06, Cadillac Escalade EXT 03-06, Cadillac Escalade ESV 04-06, ChevroletAvalanche 02-06, Cheyenne 02-07, Silverado 1500 4X4 00-07, Suburban 1500 00-06 Del Izq
382414	BH382414	27.38"	7/16 X 24 Int	Sin Rosca	Cadillac Escalade 02-06, Cadillac Escalade EXT 03-06, Cadillac Escalade ESV 04-06, ChevroletAvalanche 02-06, Cheyenne 02-07, Silverado 2500 4X4 00-07, Suburban 1500 00-06 Del Der
382415	BH382415	29.5"	7/16 X 24 Int	Sin Rosca	Chevrolet Silverado 2500 4X2 00-07 Del Izq Nacional, Chevrolet Sierra 1500 00-07 USA Del Izq
382416	BH382416	30.5"	7/16 X 24 Int	Sin Rosca	Chevrolet Silverado 1500 4X2 00-07, Silverado 2500 4X2 00-07 Del Der Nacional, Chevrolet Sierra1500 00-07 USA Del Der
382417	BH382417	31.25"	7/16 X 24	Sin Rosca	Chevrolet: Avalanche 2500 02-06, Silverado 1500HD 01-03, Silverado 2500 99-06, Silverado 350001-06, Suburban 2500 00-06, Hummer H2 05-07, Del Izq Nacional, Chevrolet: Sierra 1500HD 01-03,Sierra 2500 99-04,Sierra 2500HD 01-06, Sierra 3500 01-06, Sierra Classic 1500HD 07 Sierra Classic 2500HD 07, Sierra Classic 3500 07 USA Del Izq
382418	BH382418	30.75"	Sin Rosca	7/16 X 24 Int	Chevrolet Silverado 1500 03-07 Del Der Nacional, Chevrolet Sierra 1500 03-07 USA Del Der
382419	BH382419	31.25"	7/16 X 24	Sin Rosca	Chevrolet: Avalanche 2500 02-06, Silverado 1500HD 01-03, Silverado 2500 99-06, Silverado 01-06, Hummer H2 05-07 Del Der Nacional, Chevrolet: Sierra 1500HD 01-03,Sierra 2500 99-04,Sierra 2500HD 01-06, Sierra 3500 01-06, Sierra Classic 1500HD 07 Sierra Classic 2500HD 07, SierraClassic 3500 07 USA Del Der





No. PARTE LUSAC	No. PARTE RAYBESTOS	LARGO	MEDIDA DE CUERDA DE CONECTORES		APLICACIÓN
382422	BH382422	24.38"	M10 X 1 Int	Sin Rosca	Toyota Corolla 03-08 Del Der
382423	BH382423	24.38"	M10 X 1	Sin Rosca	Toyota Corolla 03-08 Del Izq
382426	BH382426	18.63"	M10 X 1 Int	Sin Rosca	Honda Ridgeline 07-14 Del Izq Der
382428	BH382428	19.25"	M10 X 1 Int	Sin Rosca	Honda CR-V 02-04 Tras Izq Der
382450	BH382450	22.72"	Sin Rosca	M10 X 1	Acura RL 05-11 Del Izq Der, Land Rover Discovery 00-04 Del Der
382456	BH382456	23.25"	Sin Rosca	M10 X 1 Int	Nissan Quest 04-09 Del Der
382458	BH382458	32.5"	Sin Rosca	M12 X 1 Int	Chrysler Dodge Ram 1500 06-08, Ram 2500 4X4 Heavy Duty 03-12 Del Izq, Ram 3500 Heavy Duty 08-10 Del Izq Der
382460	BH382460	11.56"	M10 X 1 Int	M10 X 1 Int	Ford Escape 01-08, Mercury Mariner 05-08 Tras Izq
382462	BH382462	17.38"	M10 X 1	M10 X 1	Ford Escape 01-08, Mercury Mariner 05-07 Del Izq Der
382463	BH382463	19.25"	Sin Rosca	7/16 X 24 Int	Chevrolet Cadillac CTS 03-07 Del Der Este numero es sustituido por LC-382629
382468	BH382468	20.5"	Sin Rosca	M10 X 1 Int	Ford Grand Marquis 03-04 Del Izq Nacional, Ford Crown Victoria 03-10, Marauder 03-04, Town Car 10 USA Del Izq
382476	BH382476	27.5"	7/16 X 243/8 X 24 Int	3/8 X 24 Int	Ford F150 4X2 99-03 Tras Central
382482	BH382482	20.25"	Sin Rosca	M10 X 1	Ford:Town Car 06-07, Grand Marquis 03-04 Tras Der Nacional, Ford: Crown Victoria 03-05 USA TrasDer
382483	BH382483	20.25"	Sin Rosca	M10 X 1	Ford:Town Car 06-07, Grand Marquis 03-04 Tras Izq Nacional, Ford:Crown Victoria 03-05 USA TrasIzq
382497	BH382497	10.08"	M10 X 1	M10 X 1	Audi A3 04-12, Volkswagen Bora 06-10, Golf A5 GTI 07-12, Jetta A5 10, Jetta A6 11-12, Passat 06-14 Tras Izq Der Nacional, Volkswagen Rabbit 09 USA Tras Iz Der
382498	BH382498	17.62"	M10 X 1	M10 X 1	Audi A8 04-10, S8 07-09 Del Izq Der
382499	BH382499	12.62"	M10 X 1	M10 X 1	BMW 525i 01-02, 528i 99-00, 530i 01-03, 540i 97-03, M5 00-03 Tras Izq Der
382502	BH382502	18.38"	M10 X 1	M10 X 1	BMW M3 01-06 Del Izq Der
382503	BH382503	21.69"	M10 X 1	M10 X 1	BMW X3 04-10 Del Izq Der
382504	BH382504	21.31"	M10 X 1	M10 X 1	BMW X3 04-10 Tras Izq Der
382505	BH382505	9.06"	M10 X 1	M10 X 1	BMW X5 07-11, X6 09-13 Tras Interior Izq
382506	BH382506	10.62"	M10 X 1	M10 X 1	BMW X5 07-11, X6 09-13 Tras Interior Der
382507	BH382507	14.06"	Sin Rosca	M10 X 1	Chevrolet: Aveo 08-14, Pontiac G3 06-09 Del Izq Der
382508	BH382508	14"	Sin Rosca	M10 X 1	Chevrolet Malibu 04-12, Pontiac G6 05-09 Tras Izq Der
382509	BH382509	11.08"	Sin Rosca	7/16 X 24	Chevrolet Blazer 03-05 Del Izq USA
382510	BH382510	11.08"	Sin Rosca	7/16 X 24	Chevrolet Blazer 03-05 Del Der USA
382518	BH382518	24.25"	Sin Rosca	3/8 X 24	Chrysler Dodge Pacifica 04-08 Del Izq
382519	BH382519	17.5"	Sin Rosca	3/8 X 24	Chrysler Town & Country 08-12, Voyager 09-12 Del Der, Volkswagen Routan 09-12 Del Der Nacional, Chrysler Dodge Grand Caravan 08-09 USA Del Der
382520	BH382520	17.5"	Sin Rosca	3/8 X 24	Chrysler Town & Country 08-12, Voyager 09-12 Del Izq, Volkswagen Routan 09-12 Del Izq Nacional, Chrysler Dodge Grand Caravan 08-09 USA Del Izq
382521	BH382521	17.5"	Sin Rosca	3/8 X 24	Chrysler 300C 5.7 Ltrs 06-09 Tras Der, Town & Country 07-09, Voyager 07-10, Charger 07-09 TrasIzq, Volkswagen Routan 09-12 Tras Izq
382522	BH382522	17.5"	Sin Rosca	3/8 X 24	Chrysler Town & Country 07-09, Voyager 07-10 Tras Der, Volkswagen Routan 09-12 Tras Der
382524	BH382524	13.7"	Sin Rosca	M10 X 1	Chrysler Dodge Ram 1500 06 Del Der
382525	BH382525	18.25"	Sin Rosca	M10 X 1	Chrysler Dodge Dakota 05-10 Del Izq Der Nacional, Mitsubishi Raider 06-09 USA Del Izq Der
382528	BH382528	19.75"	Sin Rosca	M11 X 1.5 Ext	Chrysler Dodge Ram 1500 07-08 Tras Izq
382529	BH382529	23"	M11 X 1.5 (2)	M10 X 1	Chrysler Dodge Ram 1500 07-09 Tras Central Con ABS a las 4 ruedas
382530	BH382530	(2)11.19"	(2) M11 X 1.5	(2) M10 X 1	Chrysler Dodge Ram 1500 07-09 Tras Central Con ABS a las ruedas traseras
382533	BH382533	16.12"	M10 X 1	M10 X 1	Ford Focus 06-07 Del Izq Der
382534	BH382534	14.56"	Sin Rosca	M10 X 1	Ford Focus 08-11 Del Der
382535	BH382535	14.56"	Sin Rosca	M10 X 1	Ford Focus 08-11 Del Izq
382536	BH382536	20"	Sin Rosca	3/8 X 24	Ford Explorer 02-05 Del Izq Nacional, Ford Mountaineer 02-05 USA Del Izq
382537	BH382537	20"	Sin Rosca	3/8 X 24	Ford Explorer 02-05 Del Der Nacional, Ford Mountaineer 02-05 USA Del Der
382538	BH382538	20"	Sin Rosca	(3) 3/8 X 24	Ford Explorer 02-05 Tas Izq Nacional, Ford Aviator 03-05, Mountaineer 03-05 USA Tas Izq

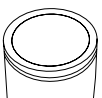



No. PARTE LUSAC	No. PARTE RAYBESTOS	LARGO	MEDIDA DE CUERDA DE CONECTORES		APLICACIÓN
382539	BH382539	19.5"	Sin Rosca	M10 X 1	Ford Expedition 02-06, Explorer 03-05, Lincoln Navigator 02-04 Tras Der Nacional, Ford Aviator 03-05, Mountaineer 03-05 USA Tras Der
382540	BH382540	17.5"	Sin Rosca	3/8 X 24	Ford Explorer 06-11, Explorer Sport Trac 07-10 Tras Der Nacional, Ford Mountaineer 06-09 USA Tras Der
382541	BH382541	17.5"	Sin Rosca	3/8 X 24	Ford Explorer 06-11, Explorer Sport Trac 07-10 Tras Izq Nacional, Ford Mountaineer 06-09 USA Tras Izq
382542	BH382542	21"	Sin Rosca	3/8 X 24	Ford Explorer 06-14, Explorer Sport Trac 07-14 Del Izq Nacional, Ford Mountaineer 06-14 USA Del Izq
382543	BH382543	20.5"	Sin Rosca	3/8 X 24	Ford Explorer 06-14, Explorer Sport Trac 07-14 Del Der Nacional, Ford Mountaineer 06-14 USA Del Der
382544	BH382544	10.62"	M10 X 1	M10 X 1	Ford Escape 06-12, Mercury Mariner 07-11 Tras De Nacional, Mazda Tribute 08 USA Tras Der
382545	BH382545	11.56"	M10 X 1	M10 X 1	Ford Escape 06-12, Mercury Mariner 07-11 Tras Izq Nacional, Mazda Tribute 08 USA Tras Izq
382546	BH382546	21.19"	Sin Rosca	(2) M10 X 1	Ford Expedition 03-04 Tras Izq
382549	BH382549	12.5"	M10 X 1	M10 X 1	Honda Civic 06-12 Del Der
382550	BH382550	22.25"	Sin Rosca	M10 X 1	Honda Civic 06-12 Del Izq
382551	BH382551	14.56"	M10 X 1	M10 X 1	Honda Civic 06-09 Tras Izq Der Disco Tambor
382552	BH382552	21.62"	Sin Rosca	M10 X 1	Honda Civic 06-12 Tras Der
382553	BH382553	21.06"	Sin Rosca	M10 X 1	Honda Civic 06-12 Tras Izq
382554	BH382554	20.5"	Sin Rosca	M10 X 1	Acura TSX 09-13 Del Der, Honda Accord 08-12 Del Der
382555	BH382555	20.5"	Sin Rosca	M10 X 1	Acura TSX 09-13 Del Izq, Honda Accord 08-12 Del Izq
382556	BH382556	20.38"	Sin Rosca	M10 X 1	Honda CR-V 05-06 Tras Izq Der
382557	BH382557	18.5"	Sin Rosca	M10 X 1	Honda Odyssey 05-10 Del Izq Der
382558	BH382558	8.62"	Sin Rosca	M10 X 1	Honda Odyssey 05-10 Tras Izq Der
382559	BH382559	22.31"	Sin Rosca	M10 X 1	Honda CR-V 07-11 Del Der
382560	BH382560	18.44"	Sin Rosca	M10 X 1	Honda CR-V 07-11 Del Izq
382564	BH382564	18.88"	Sin Rosca	M10 X 1	Nissan Armada 04-10, Titan 04-07 Del Izq Nacional, Nissan Infiniti QX56 04-06 USA Del Izq
382565	BH382565	18.88"	Sin Rosca	M10 X 1	Nissan Armada 04-10, Titan 04-07 Del Der Nacional, Nissan Infiniti QX56 04-06 USA Del Der
382567	BH382567	15"	Sin Rosca	M10 X 1	Nissan Armada 04-13, Titan 04-07 Tras Der Nacional, Nissan Infiniti QX56 04-09 USA Tras Der
382570	BH382570	20.5"	Sin Rosca	3/8 X 24	Jeep:Commander 06-10, Grand Cherokee 05-10 Del Izq
382571	BH382571	20.62"	Sin Rosca	3/8 X 24	Jeep:Commander 06-10, Grand Cherokee 05-10 Del Der
382572	BH382572	19.12"	Sin Rosca	3/8 X 24	Jeep:Grand Cherokee 06-10 Tras Der
382573	BH382573	20.25"	Sin Rosca	7/16 X 24	Jeep:Grand Cherokee 06-10 Tras Izq
382574	BH382574	15.62"	Sin Rosca	M10 X 1	Land Rover LR2 08-13 Del Izq Der
382575	BH382575	25.62"	Sin Rosca	M10 X 1	Ford Fusion 06-09, Mazda 6i 06-08 Del Izq
382576	BH382576	11.62"	Sin Rosca	M10 X 1	Ford Fusion 06-09, Mazda 6i 06-08 Tras Izq Der
382579	BH382579	18.88"	Sin Rosca	M10 X 1	Mazda CX-7 07-12, CX-9 07-11 Del Izq Der
382582	BH382582	18.25"	Sin Rosca	M10 X 1	Ford Escape 07-08, Mercury Mariner 07-08 Tras Izq
382583	BH382583	12.12"	M10 X 1	M10 X 1	Mercedes Benz C350 06-07, C55 AMG 05-07, CLK320 98-05, CLK350 06-09, CLK500 03-06, CLK55AMG 04-05, CLK63 AMG 08-09, SLK280 07-08, SLK350 05-08, SLK55 AMG 08 Tras Izq Der
382584	BH382584	15.16"	M10 X 1	M10 X 1	Mercedes Benz CL500 01-06, CL55 AMG 03-06, CL600 03-06, Del Izq Der
382585	BH382585	17"	M10 X 1	M10 X 1	Mercedes Benz CL550 07-09, CL600 07-09, S600 07-09, S350L 11-13 Del Izq Der
382586	BH382586	17.12"	M10 X 1	M10 X 1	Mercedes Benz C300 10-11, C350 08-14, E350 10-13, GLK350 09-14, SL55 AMG 03-08, SL500 03-06, SL600 07-09, SL63 AMG 09, SL65 AMG 05-09 Tras Izq Der, Mercedes Benz Sprinter 311 12-14 Sprinter 315 07-14, Sprinter 415 07-14, Sprinter 2500 07-09, Sprinter 3500 07-09 Del y Tras Izq Der
382587	BH382587	23.25"	Sin Rosca	M10 X 1	Nissan Quest 04-09 Del Izq
382588	BH382588	11.81"	Sin Rosca	M10 X 1	Nissan Quest 04-09 Tras Der
382589	BH382589	11.81"	Sin Rosca	M10 X 1	Nissan Quest 04-09 Tras Izq
382590	BH382590	15.75"	Sin Rosca	M10 X 1	Chevrolet Pontiac Solstice 06-09 Del Izq
382591	BH382591	13.5"	Sin Rosca	M10 X 1	Chevrolet Uplander 05-09, Pontiac Montana SV6 05-09 Tras Izq
382592	BH382592	19.25"	Sin Rosca	M10 X 1	Toyota Camry 07-11 Nacional, Avalon 05-09 USA Del Izq
382593	BH382593	20.19"	Sin Rosca	M10 X 1	Toyota Camry 07-11 Nacional Avalon 06-09 USA Tras Izq

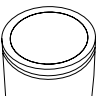



No. PARTE LUSAC	No. PARTE RAYBESTOS	LARGO	MEDIDA DE CUERDA DE CONECTORES		APLICACIÓN
382594	BH382594	23.38"	Sin Rosca	M10 X 1	Toyota Camry 07-11 Nacional, Avalon 06-09 USA Tras Der
382595	BH382595	19.25"	Sin Rosca	M10 X 1	Toyota Camry 07-11 Del Izq Para autos de fabricación japonesa
382596	BH382596	19.5"	Sin Rosca	M10 X 1	Toyota Camry 07-11 Del Der Para autos de fabricación japonesa
382597	BH382597	29.06"	Sin Rosca	M10 X 1	Toyota Rav4 06-11 Del Izq
382598	BH382598	28.06"	Sin Rosca	M10 X 1	Toyota Rav4 06-11 Del Der
382602	BH382602	16.5"	Sin Rosca	M10 X 1 Int	Chevrolet Colorado 4X2 04-12, Suburban 2500 03-05 GMC Canyon 4X2 07-12 Del Der Nacional, Chevrolet Yukon XL 2500 03-05 USA Del Der
382603	BH382603	20.88"	Sin Rosca	M10 X 1 Int	Chevrolet Colorado 4X4 04-12, GMC Canyon 4X4 07-12 Del Der Nacional, Chevrolet Yukon XL2500 03-05 USA Del Der
382606	BH382606	16.25"	Sin Rosca	M10 X 1 Int	Chevrolet Colorado 4X2 04-12, GMC Canyon 4x2 07-12 Del Izq Nacional, Chevrolet Canyon 04-05USA Del Izq
382607	BH382607	14.5"	Sin Rosca	7/16 X 24 Int	Chevrolet Cadillac CTS 03-07, CTS-V 04-07, STS 05-10, SRX 04-09 Tras Izq
382608	BH382608	11.25"	Sin Rosca	3/8 X 24 Int	Hummer H2 05-07 Tras Izq
382610	BH382610	11.56"	Sin Rosca	3/8 X 24 Int	Chevrolet Avalanche 1500 02-06, Cadillac Escalade 07-12, Escalade ESV 07-12, Escalade EXT 07-12, Suburban 1500 01-06 Tras Izq Nacional, Chevrolet Tahoe 00-06, Yukon 01-06, Yukon XL 1500 01-06 USA Tras Izq
382612	BH382612	13"	3/8 X 24	Sin Rosca	Chevrolet Silverado 1500 03-05 Tras Izq Der Nacional, Chevrolet Sierra 1500 03-05 USA Tras Izq Der
382615	BH382615	15.5" & 15"	(2) 7/16 X 24 Int	(2) 3/8 X 24 Int	Chevrolet Avalanche 07-13, Cadillac Escalade 07-12, Escalade ESV 04-06, Escalade EXT 04-06, Suburban 1500 10-11 Tahoe 07-12, Yukon 07-11 Tras Izq
382616	BH382616	24.88"	Sin Rosca	1/2 X 20 Int	Chevrolet Trail Blazer 02-07, Trail Blazer EXT 02-07 Del Der Nacional, Chevrolet Envoy 02-05, Envoy XL 02-05, Envoy XUV 04-05, Rainier 04-05, SSR 03-06 USA Del Der
382619	BH382619	13.38"	Sin Rosca	1/2 X 20 (2) Int	Chevrolet Trail Blazer 02-07, Trail Blazer EXT 02-07 Tras Izq Nacional, Chevrolet Bravada 02-04, Envoy 02-05, Envoy XL 02-05, Envoy XUV 04-05, Rainier 04-05, SSR 03-06 USA Tras Izq
382620	BH382620	17.25"	Sin Rosca y M10 X 1	M10 X 1	BMW Z4 03-09 Tras Interior Izq
382621	BH382621	9.19"	Sin Rosca y M10 X 1	M10 X 1	BMW Z4 03-09 Tras Interior Der
382622	BH382622	19"	M10 X 1	M10 X 1	Mercedes Benz Sprinter 315 07-11, Sprinter 415 07-09, Sprinter 515 07-09, Sprinter 2500 07-09, Sprinter 3500 07-09 Del y Tras Izq Der
382623	BH382623	12.95"	Sin Rosca y M10 X 1	M10 X 1	Volvo: S40 08-10 Del Izq Der Nacional, Volvo: V50 08-09 USA Del Izq Der
382627	BH382627	23.44"	Sin Rosca	M10 X 1	Toyota Camry 07-11 Tras Der
382628	BH382628	18.88"	Sin Rosca	M10 X 1	Chevrolet Cadillac: CTS 04-06 Del Izq
382629	BH382629	19.18"	Sin Rosca	7/16 X 24	Chevrolet Cadillac: CTS 04-06 Del Der
382630	BH382630	30.25"	Sin Rosca	M10 X 1	Chevrolet Venture 02-04 Tras Izq Nacional, Chevrolet Pontiac: Montana 02-05, Silhouette 02-04USA Tras Izq
382631	BH382631	11.22"	Sin Rosca	M10 X 1	Chevrolet Venture 02-04, Tras Der Nacional, Chevrolet Pontiac Montana 02-05, Silhouette 02-04USA Tras Der
382632	BH382632	18.5"	Sin Rosca	M10 X 1	Chevrolet Cadillac XLR 04-06, Corvette Brake Code JL9, GM Brake Code J55 05-13 Del Der
382643	BH382643	13.5"	Sin Rosca	M10 X 1	Toyota: Rav4 06-11 Tras Izq Der
382646	BH382646	17.5"	Sin Rosca	M10 X 1	Mitsubishi: Eclipse 06-12, Galant 04-09 Tras Izq
382647	BH382647	17.5"	Sin Rosca	M10 X 1	Mitsubishi: Eclipse 06-12, Galant 04-09 Tras Der
382648	BH382648	12.44"	M10 X 1	M10 X 1	Subaru: Outback 06-10 Tras Interior
382649	BH382649	11.19"	Sin Rosca	M10 X 1	Subaru Outback 06-10 Tras Izq Exterior
382650	BH382650	11.19"	Sin Rosca	M10 X 1	Subaru Outback 06-10 Tras Der Exterior
382651	BH382651	16.54"	Sin Rosca	M10 X 1	Suzuki SX4 08-12 Del Izq Der
382656	BH382656	18.12"	Sin Rosca	3/8 X 24	Chevrolet Silverado 1500 03-05 Tras Izq para camionetas de doble cabina largo de 18.125"
382657	BH382657	17.31"	Sin Rosca	3/8 X 24	Chevrolet Silverado 1500 03-05 Tras Der para camionetas de doble cabina largo de 17.375"
382658	BH382658	23.12"	Sin Rosca	M10 X 1	Nissan Murano 04-08 Del Izq
382659	BH382659	23"	Sin Rosca	M10 X 1	Nissan Murano 04-08 Del Der
382660	BH382660	18.7"	M10 X 1	M10 X 1	Jaguar X-Type 02-08 Del Izq Der
382664	BH382664	18.75"	Sin Rosca	M10 X 1	Ford Freestar 06-07 Del Izq
382665	BH382665	15.75"	Sin Rosca	M10 X 1	Ford Freestar 06-07 Del Der

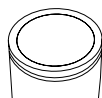



No. PARTE LUSAC	No. PARTE RAYBESTOS	LARGO	MEDIDA DE CUERDA DE CONECTORES		APLICACIÓN
382669	BH382669	23.25"	Sin Rosca	M10 X 1	Mini Cooper 02-13, Cooper S 02-08 Del Izq Der
382670	BH382670	10"	M10 X 1	M10 X 1Ext	Land Rover Discovery 97-98 Del Izq Exterior
382671	BH382671	10"	M10 X 1	M10 X 1Ext	Land Rover Discovery 97-98 Del Der Exterior
382674	BH382674	16.75"	Sin Rosca	M10 X 1	Nissan Frontier 2.4 Lts 02-04 Del Izq
382675	BH382675	16.75"	Sin Rosca	M10 X 1	Nissan Frontier 2.4 Lts 02-04 Del Der
382677	BH382677	16"	M10 X 1 (2)	M10 X 1	Chevrolet Avalanche 1500 04-05, Colorado 04-10, GMC Canyon 07-08, Tras Central
382678	BH382678	15.25"	Sin Rosca	M10 X 1	Chevrolet Malibu 04-12, Pontiac G6 05-09 Del Izq
382679	BH382679	15.25"	Sin Rosca	M10 X 1	Chevrolet Malibu 04-12, Pontiac G6 05-09 Del Der
382680	BH382680	14.75"	Sin Rosca	M10 X 1	Chevrolet Malibu 05-08 Tras Izq Disco Tambor
382681	BH382681	15.25"	Sin Rosca	3/8 X 24	Chevrolet Malibu 05-08 Tras Der Disco Tambor
382682	BH382682	32"	Sin Rosca	M10 X 1	Chrysler Dodge Aspen 07-09, Durango 05-09 Del Izq
382683	BH382683	32"	Sin Rosca	M10 X 1	Chrysler Dodge Aspen 07-09, Durango 05-09 Del Der
382684	BH382684	24.5"	Sin Rosca	M10 X 1	Ford Expedition 03-06, Lincoln Navigator 03-06 Del Izq
382685	BH382685	24.5"	Sin Rosca	M10 X 1	Ford Expedition 03-06, Lincoln Navigator 03-06 Del Der
382686	BH382686	21.75"	Sin Rosca	3/8 X 24	Ford F250 Super Duty 4X2 05-07, F350 Super Duty 4X2 05-07 Del Izq
382687	BH382687	21.25"	Sin Rosca	3/8 X 24	Ford F250 Super Duty 4X2 05-07, F350 Super Duty 4X2 05-07 Del Der
382688	BH382688	23"	Sin Rosca	3/8 X 24	Ford F450 Super Duty 05-07, F550 Super Duty 05-07 Del Izq
382689	BH382689	23"	Sin Rosca	3/8 X 24	Ford F450 Super Duty 05-07, F550 Super Duty 05-07 Del Der
382690	BH382690	21"	7/16 X 24	3/8 X 24	Ford F450 Super Duty 05-07 Tras Central
382691	BH382691	15.5"	7/16 X 24	3/8 X 24	Chevrolet Avalanche 1500 02-06 Tras Central
382692	BH382692	18"	Sin Rosca	M10 X 1	Chevrolet Corvette Brake Code J56 Brake Code J57 05-13 Del Izq
382693	BH382693	18"	Sin Rosca	M10 X 1	Chevrolet Corvette Brake Code J56, GM Brake Code J57 05-13 Del Der
382694	BH382694	30.12"	Sin Rosca	3/8 X 24	Ford Econoline E150 04-06 Del Izq
382695	BH382695	30.12"	Sin Rosca	3/8 X 24	Ford Econoline E150 04-06 Del Der
382696	BH382696	16.19"	Sin Rosca	3/8 X 24	Ford Econoline E-150 07, Econoline E-350 Super Duty 05-07, Econoline E3-50 Super Duty Ext 05-07Tras Izq
382697	BH382697	14.12"	Sin Rosca	3/8 X 24	Ford Club Wagon E150 04-07, Econoline E150 04-07 Tras Der
382700	BH382700	18.81"	Sin Rosca	M10 X 1	Chevrolet Equinox 07-08, Captiva Sport 08-14, Torrent 06-09 Del Izq, Suzuki XL-7 07-08 Del Izq
382701	BH382701	18.81"	Sin Rosca	M10 X 1	Chevrolet Equinox 07-08, Captiva Sport 08-14, Torrent 06-09 Del Der, Suzuki XL-7 07-08 Del Der
382703	BH382703	21.5"	Sin Rosca	3/8 X 24	Ford F250 Super Duty 4X4 08-10, F350 Super Duty 4X4 08-10 Del Izq
382704	BH382704	21.5"	Sin Rosca	3/8 X 24	Ford F250 Super Duty 4X4 08-10, F350 Super Duty 4X4 08-10 Del Der
382705	BH382705	26"	Sin Rosca	3/8 X 24	Ford F250 Super Duty 4X2 08-12, F350 Super Duty 4X2 08-12 Del Izq
382706	BH382706	26"	Sin Rosca	3/8 X 24	Ford F250 Super Duty 4X2 08-12, F350 Super Duty 4X2 08-12 Del Der
382707	BH382707	36.62"	Sin Rosca	3/8 X 24	Ford Econoline E-150 10, Econoline E-350 Super Duty 08-14, Econoline E-350 Super Duty Ext de9600 Lbs 06-14 Tras Izq
382708	BH382708	12"	Sin Rosca	3/8 X 24	Ford Econoline E-150 08-14, Econoline E-350 Super Duty 08-14, Econoline E-350 Super Duty Ext 08-14 Tras Der
382709	BH382709	29"	Sin Rosca	3/8 X 24	Ford F450 Super Duty 08-09, F550 Super Duty 08-10 Del Izq
382710	BH382710	29"	Sin Rosca	3/8 X 24	Ford F450 Super Duty 08-09, F550 Super Duty 08-10 Del Der
382725	BH382725	10.44"	Sin Rosca	3/8 X 24 Int	Ford F150 99-04 Disco disco Tras Der
382726	BH382726	12.06"	Sin Rosca	3/8 X 24 Int	Ford F150 02-03 Disco discoTras Izq
382727	BH382727	11.62"	Sin Rosca	3/8 X 24 Int	Ford F-150 04-08, Lincoln Mark LT 06-07 Tras Izq
382742	BH382742	19"	Sin Rosca	M10 X 1 Int	Chevrolet Equinox 05-06 Del Izq
382762	BH382762	38"	Sin Rosca	M10 X 1 Int	Chrysler Dodge Durango 03 Del Der
7838625	BH38625	N/D	N/D	N/D	Ford Tras F-150 80-91, F-200 87-91, F-350 80-86
1185M	BH38316	25.13"	7/16 X 24	3/8 X 24	Ford Del Camion. F-600 80-85
2032M	BH36892	11"	M10 X 1	M10 X 1	Nissan Tras Tsuru I 84-87, Tsuru II 88-92, Samurai 81-82, Ninja Turbo 86-87 Sakura 85-86
4005M	BH36749	19"	Sin Rosca	3/8 X 24	Ford Del Izq F-100 73-79
4019M		N/D	N/D	N/D	Chrysler Delantera Izquierda Dodge Super Bee 76-79.
4021M	BH36830	17.63"	Sin Rosca	3/8 X 24	Chrysler Del Izq Dodge Le Baron 78-80
4022M	BH38054	15.25"	M10 X 1	M10 X 1	Chrysler Del Izq Dodge Cordoba 80-82, Le Baron 81-82, Magnum 81-82, Valiant Volare 80-81.





No. PARTE LUSAC	No. PARTE RAYBESTOS	LARGO	MEDIDA DE CUERDA DE CONECTORES		APLICACIÓN
5022M	BH36829	13"	3/8 X 24 Int7/16 X 24 Ext	3/8 X 24	Ford Tras Mustang 79-84; Fairmont y Fairmont Vagoneta 78-83, Cougar 85-88, Thundebird 85-89, Grand Marquis 83-84. VAM Tras Rally 77-83, VAM Tras Rally 77-83
6032M		N/D	N/D	N/D	Volkswaegen Caribe 78-87 Del
7005M	BH27299	10.75"	M10 X 1	M10 X 1	Volkswagen Tras Combi 70-88, Sedan 63-04; Brasilia 74-82 Panel 70-88
7007M	BH36900	7.25"	M10 X 1	M10 X 1	Volkswagen. Tras Caribe, 78-87 Atlantic 77-87, Caribe GTI 83-86, Corsar 83-88, Corsar Variant 86-88, Derby 95-97, Golf A2 C, CL, GL, 87-92, Golf A3 CL, GL 93-99, Golf A3 GLS 93-99, Jetta A2 87-92 Tras Izq Passat Vagoneta y VR6 (F.Disco) 96-97, Eurovan L-5 2.5 Lts. 01-04 Del Izq Eurovan VR-6 2.8 Lts 00-02
BH38353		N/D	N/D	N/D	#N/A
BH38615		N/D	N/D	N/D	#N/A
BH38049		N/D	N/D	N/D	#N/A
BH381304		N/D	N/D	N/D	#N/A

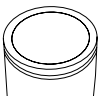



Pistones FD		
NO. DE PARTE LUSAC	DIAMETRO	APLICACIÓN
832	48.0 mm 1-57/64"	Chevrolet Chevy Joy 94-03. Chevy Swing 94-03, Chevy Monza 97-03. Chevy Pop 96-03. Chevy-Vagoneta 00-03. Chevy Pick Up 99-04 Chevy C2 04-12, Chevy C2 Sedan 05-07 Delantero.
2160	50.8 mm 2"	Chevrolet Express 1500 07-13 de 6 Birlos, Silverado 1500 4 X 2 4 X 4 00-01 y 03-06. Silverado 2500 4X 2 4 X 4 00-01 y 03-06. Silverado 3500 4 X 2, 4 X 4 96-05. Silverado 3500 HD 4 X 2, 4 X 4 96-06. Suburban 00-06, Trasero, Chevrolet Sonora 00-06, Cheyenne C-20, C-25 01-06 Delantero. Caliper Doble Piston
2724	50.8 mm 2"	Chrysler Atos 01-12 Delantero
2900	48.0 mm 1-57/64"	Volkswagen Pointer 98-09. Pointer City 00-10, Pointer Treanline 06-09 Pointer Vagoneta 99-02, Pointer Pick Up 99-07 Delantero
2902	54.0 mm 2-1/8"	Volkswagen Beetle 1.8, 2.0 98-10, Golf A3 GTI VR6 95-99. Golf A4 00-10. Golf GTI A4 00-05, Jetta VR6 2.8 Lts A-3 95-99. Jetta A4 00-10. Jetta VR6 96-04. Passat VR6 96-97. Passat y Passat Wagon 96-97, Golf GTI A-3 2.0 L S/ABS 99, Golf GTI A-4 2.0 L S/ABS 00-05, Beetle Turbo 1.8L 00-05, Polo 03-07, Lupo 05-07, Cross Fox 07-11 Delantero. Seat Alhambra 02-03. Cordoba 01-08. Ibiza 01-08, Toledo 01-06, Seat León Signo 03-04, León Reference 07-10, León Stella 03-04, León Stylace 05-10, León Cupra 05-10 Delantero
2904	54.0 mm 2-1/8"	Volkswagen. Pointer 98-09. Pointer City 00-09. Pointer MI 2.0 Lts. 03-04, Pointer GTI 00-02, Pointer Vagoneta 99-04. Delantero
4000	48.0 mm 1-57/64"	Renault 12 TL, TS 72-84. Delantero
4005	45.0 mm	Renault R5 TL 76-85. Delantero
4019	48.0 mm 1-57/64"	Renault R-18 80-84. Tipo Girling. Delantero
6000	8.0 mm 1-57/64"	Chevrolet Trail Blazer 4X2 LS, LT, 4X4 02-06. Trail Blazer 4X4 EXT. 04-06 Trasero Sello grueso paracaliper Delphi, sello delgado para caliper GM, Geo Tracker 93-95 y 98-06, Nissan Hikari 88-92, Ninja Turbo 86-87, Sakura 85-86, Samurai 81-87, Tsuru I 84-87, Tsuru II 88-92, Tsuru III GS 93-14, Tsubame 93-04, Sentra 1.6 Lts. 92. Delantero
76008	74.6 mm 2-15/16"	Chevrolet Blazer Nevada 91. Caprice 78-82, Chevelle 70-75, Chevelle Malibu 70-75, Chevy Nova 73-78, Impala 70-75, C-10 71-78, C-15 82-87, C-20, 25 79-87. C-30, 35 71-78. G-20 95. Suburban 87-88. VAM Wagoner 77-86. Wagoneer J-164 74-76. Dina 1000 77-83, Dina 3000, 3200 77-83. Delantero
76014	41.3 mm 1-5/8"	Chrysler Dodge Dart 70-73, Valiant Duster 70-73. Delantero
76018	69.8 mm 2-3/4"	Chrysler Cordoba 80-82, Dart 76-82, Valiant Duster 76, Le Baron 78-82. Magnum 81-82, Monaco 70-73. D-100 72-73. D-300 72-78. Valiant Volare 77-81, Chrysler Cordoba 82, Valiant Volare 80-81, Le Baron 81-82, Ford Galaxie 70-74. Delantero.
76021	78.6 mm 3-3/32"	Ford Ltd 75-78, Chrysler Monaco 74-77. D-100 73-80, D-150 81-93, D-250 86-93, D-300 72-80, D-350 81-93, Microbus 81-93, M-300 78, W-150 85-87, W-250 4X4 86-93, VAM Classic 76, Gremlin 74-83. Con Caliper Bendix, Pacer 76-79, Rally 73-75. Jeep CJ-5 78. Caliper Bendix. Delantero.
76024	73.0 mm 2-7/8"	Ford F-150 86-89 y 92-93, F-200 2A. Versión 86, Caliper de Un Piston, Ford F-100 73-79, F-150 84-85 y 90-91, P-350 Microbus 77-78. Caliper de Un Piston. Delantero.
76025	65.9 mm 2-19/32"	Ford F-150 80-83. Delantero
76026	78.6 mm 3-3/32"	Chrysler M-300 80, Chrysler M-300 78, Ram Charger 86-96, Ram Van 1500 95-97. Ram Wagon 1500 95-97. Ram Van 2500 96-97. Ram Wagon 2500 96-97. Ram Van 3500 96-97. Ram Wagon 3500 96-97, Dina Camta. 1000 75-77. Delantero.
76027	65.9 mm 2-19/32"	Chrysler Dart 73-76, Valiant Duster 73-76, Ford Maverick 74-77. Mustang 74-78, VAM American 77-83, Classic 76 Sin Boster, Rally 76-83, Jeep CJ-5 78. Delantero.
76028	85.7 mm 3-3/8"	Chevrolet C-30, C-35 84-87, C-35, C-3500, C-3500 HD 96-00, Microbus 88-00, Panel P-30 82-92 y 94-98 Delantero, Chevrolet C-30, C35 96-00 Trasero, Dina Camta. 3000, 3200 75-77 Delantero.
76033	63.5 mm 2-1/2"	Chevrolet Silhouette 91-92 y 94-95, Chevrolet Blazer 95-97, Chevelle Malibu 79-81. Monte Carlo 81-84, Century 83-96, Cutlass 90-96, Cutlas Eurosport 90-96, S-10 Pick Up 95-04 Delantero
85013	50.8 mm 2"	Ford F-150 97-99, Ford Lobo 150 Y 250 99-04 s/c vel, Ford F-250 Sup. Duty 4x4 03-04, Ford Lincoln Blackwood 03 Caliper Doble Piston Delantero.
85019	73.0 mm 2-7/8"	Ford Club Wagon V6 E-150 95-03. Club Wagon V8 E-250 97-04. Econoline Van E-150 95-07, Econoline Wagon E-350 Diesel 01 y 03, Club Wagon V8 E-350 97-98. F-150 94-99. Delantero
85029	57.1 mm 2-1/4"	Chrysler PT Cruiser 01-08, PT Cruiser Turbo Convertible 03-08 Delantero
85038	69.8 mm 2-3/4"	Chrysler Dodge Durango 98-02 Delantero
85055	66.7 mm 2-5/8"	Ford Aerostar 91-95. Explorer XLS V6, XLT V8, Limited. 91-94. Delantero
85076	60.3 mm 2-3/8"	Chrysler Grand Voyager 84-93 Rin 14" USA. Delantero
85080	73.0 mm 2-7/8"	Chevrolet Camion C-50 y C-60 83-90 Delantero y Trasero USA.
85081	63.5 mm 2-1/2"	Kodiak 97-03 Delantero/Trasero
85088	63.5 mm 2-1/2"	Chevrolet Cadillac Seville 94-97, Seville STS 98-04 Cadillac DeVille 97-04, Grand Prix GT, Se. 97-01, Impala 00-04, Venture APV 97-04, Pontiac Montana 05-09, Pontiac Torrent 06, Venture APV 97-04, Uplander 05-09 Delantero
85119	45.0 mm	Chevrolet Trail Blazer 02-06 Delantero. Chevrolet Sonora 00-06 Trasero. Chevrolet Avalanche 4x2 02-03 Trasero. Chevrolet Avalanche 4x4 02-04 Trasero. Chevrolet Avalanche 4x4 02-04 Tras. Chevrolet Avalanche 4x4 V8 5.3 Lts. 05-06 Trasero. Cadillac Escalade 2x4 5.3 Lts. 02-06 Trasero Cadillac Escalade 4x4 6.0 Lts. 02-06 Trasero Cadillac Escalade EXT 4x4 03-06 Trasero. Chevrolet Suburban 1500 00-04 Caliper doble piston Delantero Cubre polvo duro, Ford Mustang GT 98-04. Caliper doble piston Delantero.

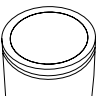



Pistones FD		
NO. DE PARTE LUSAC	DIAMETRO	APLICACIÓN
85135	64.3 mm 2-17/32"	Honda Odyssey 00-10 Delantero
85148	46.4 mm 1-53/64"	Nissan X Terra 00-05, X Terra S, X Terra SE 06-07 Delantero
85152	64.0 mm	Chrysler Grand Voyager 01-06, Town & Country 01-07. Voyager 01-07 Delantero Disco Tambor, Pontiac Aztek 4X4 01-05 Delantero
85153	66.0 mm	Chrysler Jeep Liberty 02-13, Chrysler Dodge Nitro 07-10, Journey 09-11, Wrangler 07-10 TownCountry 08-12 Nacional, Caravan 08-10 USA Delantero
85155	59.5 mm 2-11/32"	Ford Econoline E-350 99 y 06-07. Econoline E-350 Van Diesel 06-07, Club Wagon V8 E-250 95-96, Club Wagon V8 E-250 Chateau 99-00. Econoline Club Wagon V8 E-350 XL 99-06, Club Wagon V8 E-350 XL 95-96. Trasero F-450 V8 Super Duty 97-02. Delantero. y Trasero
85156	80.2 mm 3-5/32"	Chevrolet C-30, 35 88-95. G-30 97-02. Express 3500, Express Cargo Van 3500. 97-02. (8 Birlos)Delantero
85157	74.6 mm 2-15/16"	Chevrolet Suburban 88-00, Blazer Nevada 92-94. C-15 94-99, C-20, C-25 y Cheyenne 92-01, C-350002-08, G-15 98-01. G-15 Express 1500, Express Cargo Van 1500. 98-01, y 03-06 Doble piston. Express 2500, Express Cargo Van 2500. 99-06, Maxi Cab 91-93. Silverado 1500 95-99, Chrysler RamCharger 99, Ram 1500 94-00, Ram 2500 91-00, Ram Runner V-10 96-97. Delantero Caliper sencillo, Avalanche 02-06. Cadillac De Ville 90-93, 97-99, Cadillac Escalade 02-06. Cadillac Escalade Ext 03-06. Silverado 1500 00-01 y 03-06, Silverado 2500 00-01 y 03-06. Silverado 3500 96-06. Sonora 00-06. Suburban 00-06 G-15 02-05. G-15 Express 1500, Express Cargo Van 1500. 02-06. Express 2500, Express Cargo Van 2500. 02-06. Delantero Caliper doble piston
85158	63.5 mm 2-1/2"	Chevrolet C-15 88-91. C-20, 25 88-91. Delantero
85159	42.1 mm 1-21/32"	Chevrolet Buick Regal 94-96. Delantero
85163	36.1 mm 1-27/64"	Chrysler Cirrus Sedan 01-05, Concord 01-02, Imperial 91, Intrepid 98-01. Stratus 98-05, 300 M 99-04, Rin 15" y 16" Pt Cruiser 01-08, Pt Cruiser Turbo 03-07, Pt Cruiser Convertible 03-08 Trasero
85171	65.9 mm 2-19/32"	Ford Cougar 90-92. Thunderbird 89-92, Delantero
85177	42.8 mm 1-11/16"	Nissan NP300 09-12, Pathfinder XE 97-98. Pick Up D-21 92-10. Pick-Up Doble Cabina 97-10. Pick Up Corto 90-00. Pick -Up King Cab 95-00. Pick-Up Largo 97-10. Pick-Up 250 94-96, Estaquitas Pick Up 72-10, Nissan Cta. Frontier 4 cil. 00-04, Urvano 00-01 Delantero Caliper Doble Piston.
85179	42.8 mm 1-11/16"	Nissan D21 92-00. USA. Infiniti Q-45 94-96. Delantero Caliper doble piston
85206	86.1 mm 3-25/64"	Chrysler Ram 3500 94-99. Ram 4000 95-99. Ram Srt-10 05-06. Chevrolet C-30, 35 90 y 92-00. Panel P-30 98-00, C-35, C-3500 HD 96-00, Panel P-30 01-03 Delantero
85209	54.0 mm 2-1/8"	Chevrolet Aveo 08-14, Opra 06-10, Chrysler Verna 04-06, Mitsubishi Lancer 04-09, Lancer Ralliart 05-06, Lancer DE ABS, Lancer ES 07-08, Nissan Lucino GSE 96-00, Lucino GSR 96-00. Sentra 1.6 LTS. 96-00; Sentra 2.0 LTS. 96-01; Tsuru GSR 2000 Sin ABS. 93-96, Suzuki Swift 07-09 Delantero
85215	48.0 mm 1-57/64"	Nissan Aprio 08-10, Platina 02-10, Renault Clio 02-10, Clio Expression 04-10, Clio Energy 07-09, Renault Sandero 10-12 Delantero
85216	44.4 mm 1-3/4"	Nissan Cta. X-trail 01-10, Nissan Cta. Pathfinder Xe 99-04, Nissan Cta. Frontier V6 01-04 Delantero Caliper Doble piston
85218	57.1 mm 2-1/4"	Nissan Almera 01-05 Delantero
85242	50.8 mm 2"	Ford Freestar 04-07 Delantero
85258	54.0 mm 2-1/8"	Chevrolet Meriva 04-08 Delantero
85261	57.1 mm 2-1/4"	Cadillac Catera 97-01 Delantero
85262	40.0 mm	Cadillac Catera 97-01 Trasero
85275	45.0 mm	Chevrolet Camaro 98-02 Del. Línea Nueva Pontiac Firebird, Tran Am 98-02. caliper doble piston. Delantero
85384	54.0 mm 2-1/8"	Ford Escort 94-01. Escort LX 94-01, Escort Vagoneta 94-99. Escort GT 94-95. Delantero
85389	57.1 mm 2-1/4"	Chevrolet Cavalier 92-04, Cavalier Z-24 92-96, Sunfire 97-02 y 04-05. Delantero
85390	48.0 mm 1-57/64"	Chevrolet Corsa Sedan 03-08, Corsa 02-08, Tornado 04-11. Delantero
85391	57.1 mm 2-1/4"	Audi A4 05-10, Chevrolet Astra 1.8 Lts. 00-03 Sin ABS. Chev. Astra 2.0 Lts. 03-08, Astra 2.2 Lts. Elegance 00-04. Con ABS, Chevrolet Zafira 02-06, Volkswagen Passat L/N 02-11 Delantero
85392	66.0 mm	Chrysler Jeep Cherokee Sport 94 y 98-01, Jeep Grand Cherokee 93-98, Jeep Wrangler 93-02, Jeep Wrangler Sahara 97-02, Jeep Wrangler Unlimited, Jeep Wrangler Rubicon 03-06, Vam Jeep CJ-5 84-86, Caliper ATE, Chrysler Town & Country 01-07, Voyager 01-08 Disco Disco Nacional Caravan 01-07 USA Caliper ATE Delelantero
85393	57.1 mm 2-1/4"	Ford Mondeo Core 01-07. Mondeo Trend 01-07, Mondeo Ghia 01-07, Honda Accord 4 Cil. 96-12, Honda Accord V6 98-06 Nacional, Odyssey 95-99 USA Delantero
85401	60.3 mm 2-3/8"	Chrysler Sebring R/T 98-00. USA. Delantero
85402	54.0 mm 2-1/8"	Honda Civic EX, SI 97-10, Nissan Tiida 07-11 Delantero
85424	47.6 mm 1-7/8"	Ford Grand Marquis 92-04. Lincoln Town Car 91-00. Trasero
85425	38.1 mm 1-1/2"	Nissan Infiniti Q45 94-96. Trasero
85438	65.9 mm 2-19/32"	Ford Grand Marquis 95-97. Lincoln Town Car ABS. 95-00. Mustnag GT 98, Ford Lincoln Continental 97-99, Lincoln Town Car 95-00, Lincoln Mark VIII 94-96, Sable 94-04. Sable Vagoneta 94-97. Windstar GL, LX 95-98. Delantero

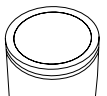



Pistones FD		
NO. DE PARTE LUSAC	DIAMETRO	APLICACIÓN
85456	48.0 mm 1-57/64"	Ford Explorer XLS V6, XLT V8, Limited s/cont/vel 95-10 Tras. Explorer Sport s/c de tracc, y c/c detracc. 4x2 94-95 y 98-03, Lincoln Aviator 03-05 Trasero, Jeep Liberty 03-13 Tras, Jeep Wrangler, Jeep Wrangler Sahara, Jeep Wrangler Rubicon 03-06 Jeep Gran Cherokee 95-98 Trasero
85469	54.0 mm 2-1/8"	Chrysler Breeze 96. Cirrus 96- 00. Cirrus Coupe 99-00. Cirrus Convertible 01-05. Sebring 97. Stratus95-97, Stratus R-14 95-00, Stratus R-15 96-97. Delantero
85470	60.3 mm 2-3/8"	Chrysler Stratus 98-06, Cirrus 01-07 Delantero
85471	59.5 mm 2-11/32"	Chevrolet C-30, C-35, C-3500 Heavy Duty 03-07 Caliper doble piston Delantero y trasero, Ford F-450V10 Super Duty 99-13, F-450 V8 Diesel Super Duty 05-13, F-550 V10 Super Duty 01-13. Del y Tras caliper doble piston Cubrepolvo duro. International CF500 06-13, CF600 06-13 Delantero y trasero
85472	57.1 mm 2-1/4"	Nissan Altima 96-12, Maxima 00-14, 240 SX 93-98, Infiniti I-30 00-01, Nissan Sentra XE, Sentra GXE01-09, Nissan Sentra 07-12 Delantero
85475	46.0 mm 1-13/16"	Chevrolet Trail Blazer 4 X 2 LS, LT. 02-06. Blazer 98-01, Delantero Doble Pistón
85476	38.1 mm 1-1/2"	Chevrolet Venture APV 98-04. Pontiac Montana SV6 05-07 Trasero. Pontiac Astek 01-05 Trasero. Chevrolet Impala C/S/ ABS 00-04 Tras Grand Prix GT, GTp, Se. 97-01, Toyota Camry 02-11, Toyota Solara 05-07, Mitsubishi Outlander 04-10 4 cil. 2.4L, Honda Pilot 03-08 Trasero Cubrepolvo Suave
85477	48.0 mm 1-57/64"	Ford Grand Marquis 98-04. Lincoln Town Car 98-07, F-150 97-04 Caliper doble piston Delantero
85484	60.3 mm 2-3/8"	Chevrolet Luv 97-05, Nissan Rogue 08-11 Delantero
85486	47.6 mm 1-7/8"	Nissan Urvan 00-10, Nissan Quest V6 305 L 04-09, Caliper Doble Piston Delantero
85488	45.0 mm	Chevrolet Camaro Z 28 Trasero. 98-02, Pontiac Firebird Trans Am 98-01 Trasero
85489	45.0 mm	Chrysler Dodge Ram 1500 03-07, Ram 2500 01-07, Ram 4000 03-07 Trasero
85491	48.0 mm 1-57/64"	Ford Explorer XLS V6, XLT V8, Limited s/cont/vel 95-10 Tras. Explorer Sport s/c de tracc, y c/c detracc. 4x2 94-95 y 98-03, Mercury Mountaineer 05 Trasero
85492	44.0 mm	Ford Windstar GL, LX s/c.de tracc, y c/c de tracc. 95-98 Tras. Windstar LX, SE, SE Limited s/c.detracc, y c/c de tracc. 99-03 Trasero
85496	48.0 mm 1-57/64"	Chevrolet Matiz 04-05, Matiz G2 06-11 Delantero
85800	60.0 mm	Ford Contour 96-00, Escape 01-10. Mystique 95-00, Mercury Mariner 05-08 Delantero
85810	54.0 mm 2-1/8"	Audi A1 11-13, A3 02-13, S3 12, Ford Focus LX, SE, ZTS, Wagon 00-06. Focus ZX3 00-04, FocusS-VT 02. Volkswagen Beetle 98-14, Bora 06-10, Golf A4 07-10, Golf GTI 07-13, Jetta A4 99-09, Jetta A6 11-13, Jetta Clasico 10-14, Delantero Caliper Sencillo, Ford Expedition XLT, Eddie Bauer sin y con/ctrol de velocidad 03-06 Del.. Lincoln Navigator 03-05 Delantero. Caliper Doble Piston.
85812	54.0 mm 2-1/8"	Fiat Palio Adventure 04-11, Fiat Palio Sedan 04-08 Ford Eco Sport 04-10, Fiesta 98-01 y 03-06, FiestaSedan 05-06, Fiesta Sedan First, Fiesta Sedan Trend 07-14, Fiesta Ikon 01-07, KA 01-03, KA Sport 04-08, Courier Pick up 01-10 Del. Para autos que lleva la balata 7259-D649, Volkswagen Pointer Vagoneta 99-00, Mazda Mazda2 12-14 Delantero
85813	48.0 mm 1-57/64"	Ford Fiesta 98-06, Fiesta Ikon 01 Delantero para autos que llevan la balata C0175, Mini Cooper 02-06 Delantero
85814	48.0 mm 1-57/64"	Ford Windstar 99-03. Doble piston Delantero
85815	54.0 mm 2-1/8"	Ford Excursion 4X2 y 4X4 01-05. F- 250, F-250 y Super Duty 99-04 Doble piston Delantero F-350 Super Duty 99-04 Ford Triton 99-03. Doble piston Delantero Trasero
85817	48.0 mm 1-57/64"	Ford F-150 97-03, F-150 XL 04, Renault Alliance 84-86, Encore 85-86 Delantero
85826	50.8 mm 2"	Ford Expedition XLT 97-02, Expedition Eddie Bauer 97-02, F- 250, F-250 Super Duty 98-02. Lincoln Navigator 98-02. Doble piston Delantero
85827	50.8 mm 2"	Ford Expedition 97-02, F-150 97-04, F-250 97-02, Ford F-250 Sup. Duty 4x4 03-04, Ford Lobo 150 Y250 97-04, Lincoln Town Car 03-06, Navigator 98-02 Caliper sencillo trasero
85857	46.0 mm 1-13/16"	Chevrolet Equinox 05-08, Ford Explorer XLS V6, XLT V8, Limited. 95-02. Ranger 96-11 Doble piston Delantero
85860	54.0 mm 2-1/8"	Nissan Micra 05-07, Peugeot 206 00-10, 206 XR 00-10, 206 XT 03-10, 307 Sedan XR 03-09, Peugeot Partner 04-08, Renault Megane 01-03, Megane II Sedan 04-07, Megane II Coupe Convertible 05-07, Megane II Sport 07, Megane II 05-10, Kangoo Pasajeros 07-10, Kangoo Express 04-10, Renault Scenic 01-09, Trafic Carga, Trafic 9 Pasajeros 07-09, Seat Alhambra 02-03, Cordoba 01-09, Ibiza 01-09, Toledo 01-03, Volkswagen Derby 01-09, Golf A4 Cabrio 00-02, Golf A3 GTI 93-98, Golf A3 GTI VR6 95-99, Jetta A3 GLS, Jetta A3 Europa 93-99, Eurovan VR6 2.8 LTS 00-02, Passat 91-93 y 96-05, Passat Vagoneta 91-92, Volkswagen Van 03-09 Delantero
96363	40.0 mm	Volkswagen Brasilia 74-82, Sedan 95-04 Delantero.
96373	54.0 mm 2-1/8"	Volkswagen Combi Panel 73-01. calibrador ATE Delantero
96388	44.0 mm	Volkswagen Atlantic 81-87, Caribe 77-87, Corsar 83-84. Calibrador Ate, Caribe GT 83-86. Delantero
96540	50.8 mm 2"	Nissan Datsun Sedan 73-84, Sakura 82-84, Estaquitas Pick Up. 72-78. Delantero
96542	60.3 mm 2-3/8"	Mitsubishi Outlander 04-06 4 cil. 2.4L, Eclipse 06-09, Nissan Ichi Van 87-94, Estaquitas 72-03. Pick Up D-21 92-03. Pick-Up Doble Cabina 82-00. Pick Up Corto 90-00. Pick -Up King Cab 95-00. Pick-Up Largo 97-03. Pick-Up 250 94-96 Delantero, Nissan Pick Up D-21 92-00. Delantero. Americana Caliper de 1 Pistón USA.
98726	44.0 mm	Volkswagen Atlantic 81-87, Caribe 77-87, Caribe GT 83-86, Corsar 83-84, Caliper Girling. Delantero

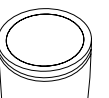



Pistones FD		
NO. DE PARTE LUSAC	DIAMETRO	APLICACIÓN
98728	48.0 mm 1-57/64"	Volkswagen Golf A-3 CL, GL. 93-99. Golf A-2 C, CL, GL 87-92. Golf A-3 GLS 93-99. Golf Cabrio A-3 96-99. Golf GTI A-2 89-92. Jetta A-2 87-92. Jetta A-3 CL, GL. 93-99. Corsar 85-88, Corsar Variant 86-88. Derby 95-00, Volkswagen Van 03-09 Delantero.
98899	73.0 mm 2-7/8"	Ford Crown Victoria 81, Gran Marquis 82-84 y 92-94, Lincoln Town Car 91-94, Ford Ltd 79-80. Delantero
99080	60.0 mm	Ford Cougar 85-88, 93-95. Cougar XR-7 90-94, Fairmont 78-83, Mustang 79-84, Thunderbird 85-88 y 93-96. Cubre Polvo Suave. Delantero
99980	55.6 mm 2-3/16"	Ford F-200 86-91, F-250 92-94. F-350 73-94. P-350 76-91, P-35 Microbus 89-95. Delantero.
100799	57.1 mm 2-1/4"	Chevrolet Cavalier 90-91. Cavalier Z-24 91. Celebrity 82-89, Citation 82-86, Cutlass 87-89, Cutlass Eurosport 87-89. Delantero
107534	54.0 mm 2-1/8"	Chrysler Dodge Durango 03-06 Tras., Durango SLT, Durango Limited 05-06, Ram 1500 03-08 Del/Tras., Ram Van 1500, Ram Wagon 1500 02-03, Ram 2500, Ram 2500 Quad Cab 03-04, Aspen 07-09 Trasero Caliper sencillo, Chrysler Dart "K" y Guayin 82-88, Dart "E" 89, Le Baron "K" 83-87, Magnum "K" 83-88, Neon 95-05. New Yorker 85-89, Phantom 87-89, Serie 600 "K" 84-85, Shadow 89-94, Shadow GTS Turbo 89, Spirit 90-95, Volare "K" 82-88, Delantero caliper sencillo, Ram Van 1500 98-03, Ram Wagon 1500 98-03, Ram 1500 01-08, Ram 2500 01-04, Ram Van 2500 98-02, Ram Wagon 2500 98-02, Ram Charger 00-01. Delantero Caliper Doble piston, Ram 1500 03-08, Ram Van 1500 02-03, Ram Wagon 1500 02-03, Caliper trasero sencillo.
108159	60.0 mm	Chrysler Concorde 93-97 Y 01-02, Imperial 91, Intrepid 94-01, Le Baron 92-95, New Yorker 90-94, New Yorker LH, LHS 94-97, Phantom 90-94, Spirit R/T 91-95, 300 M 99-04, Grand Voyager 91-00, Town & Country 93-00, Voyager 94-00, Ford Ghia 91-94, Topaz 84-94, Nissan Quest Xe 97-02. Delantero
115614	65.9 mm 2-19/32"	Chrysler Dakota 96, Ford Taurus 88-91 Delantero.
119043	34.9 mm 1-3/8"	Chrysler Cirrus 96-05., Cirrus Coupe 99-00., Cirrus Convertible 01-05, Concorde 93-97, Intrepid 94-97, Le Baron 92-95, Neon 95-05, New Yorker 90-97, LHS 94-97, Phantom 90-94, Sebring R/T 97, Shadow GTS y turbo 89, Spirit R/T 91-95, Stratus 96-06, Trasero
850020	42.0 mm	Chrysler Voyager 01-08 Trasero
850300	55.9 mm 2-13/64"	Chrysler Ram Van 3500, Ram Wagon 3500 98-02 Ram 4000 00-02 y 05-06, Delantero Caliper Doble Piston, Ford Club Wagon V8 E-250 95-96. Club Wagon V8 E-250 Chateau 95-96 y 98-00. Econoline Club Wagon V8 E-350 XL 99-06, Econoline Club Wagon V8 E-350 XL 95-96. Econoline Van E-250 97-99. Econoline Van E-350 98-99 y 06-07. Econoline Van E-350 Diesel 06-07, F-350 95-04. F-250 95-97, P-350 Microbus 94-97. Caliper doble piston Delantero.
850390	54.0 mm 2-1/8"	Chrysler Dodge Durango 03-09, Ram 1500 01-05, Ram 2500 01-08 Caliper doble piston Delantero, Chrysler Durango 03-09, Ram 1500 01-11, Ram 2500 06-11 Trasero caliper sencillo
850400	52.0 mm 2-3/64"	Chevrolet Astra 1.8 Lts. 00-03 y 07-08, Chev. Astra 2.0 Lts. 03-06. Astra 2.2 Lts. Elegance 00-04, Astra Vagoneta 01-03, Astra Turbo 07-08, Sin ABS Delantero
850450	48.0 mm 1-57/64"	Chrysler Jeep Commander 06-10, Jeep Grand Cherokee 99-10 Delantero. caliper doble piston Teves doble piston, Jeep Commander 06-10, Jeep Grand Cherokee 99-10 Trasero Caliper sencillo
850460	47.6 mm 1-7/8"	Chrysler Jeep Commander 06-10, Jeep Grand Cherokee 99-10, Caliper Akebono doble piston Delantero
850700	48.0 mm 1-57/64"	Ford Explorer 03-05, Ford Explorer Sport 94-95 y 98-03, Ford Ranger 04-07. Caliper doble piston Delantero.
850790	52.0 mm 2-3/64"	Ford Expedition XLT, Eddie Bauer sin y con/ctrol de velocidad 03-06, Lincoln Navigator 03-06 Trasero.
850810	44.4 mm 1-3/4"	Ford Excursión 2x4 sin/con control de velocidad 01-05, Ford Excursión 4x4 sin/con control de velocidad 01-05, Ford F-350 Super Duty 00-04. Caliper doble piston Trasero
851001	63.5 mm 2-1/2"	Nissan Murano S, Murano SL, Murano SE 04-10 Delantero
851002	45.5 mm	Toyota Tacoma SR5, Tacoma TRD Sport 06-14, Toyota 4 Runner 03-09 Delantero Caliper de 4 pistones
851010	50.8 mm 2"	Chevrolet Express 2500 03-14, Express 3500 02-14 de 8 Birlos Trasero
851013	54.0 mm 2-1/8"	Chevrolet Pontiac G5 Sedan, Sedan LS 07-09, Pontiac G5, Sedan GT, Pontiac Coupe GT 07-09, Pontiac G6 05-09 Delantero
851014	54.0 mm 2-1/8"	Toyota Yaris Hatch Back 06-07, Yaris Sedan 07-14 Delantero
851015	57.1 mm 2-1/4"	Ford Focus 07-11, Focus Europa L/N 07-09, Mazda 3 Sedan i 06-14, Mazda 3 Sedan s 06-14, Mazda 3HB s 06-14, Mazda 5 06-12, Volkswagen Sharan 02-08 Delantero
851016	57.1 mm 2-1/4"	Isuzu ELF 300 08-09, ELF 400 07-09, ELF 450 4 Cilindros Diesel 07-09 Delantero
851042	60.0 mm	Chrysler H-100 03-10, H 100 Pick up y Chasis Cabina 03-10 Del. Motor a gasolina.
851047	60.0 mm	Chevrolet Vectra 03-08, Volkswagen Eurovan Diesel 06-10 Delantero
851050	54.0 mm 2-1/8"	Renault Kango Express 04-10 Delantero
851055	60.3 mm 2-3/8"	Mitsubishi Galant 03-09, Mitsubishi Outlander 04-06 4 cil. 2.4L, Eclipse 06-12 Delantero
851067	54.0 mm 2-1/8"	Dodge Attitude 06-11 Delantero.
851070	57.1 mm 2-1/4"	Chevrolet G-30 03-05, Express 2500 07-13, Express 3500 02-06, Express Cargo Van 2500 02-13, Express Cargo Van 3500 02-14 Delantero, Hummer H2 05-07 Delantero y trasero, Cadillac DTS 06 Caliper Doble Piston Delantero
851075	66.7 mm 2-5/8"	Toyota Hiace Carga, largo, corto y pasajeros 06-13 delantero
851076	42.8 mm 1-11/16"	Toyota Hilux 04-10 Delantero

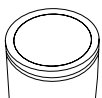



Pistones FD		
NO. DE PARTE LUSAC	DIAMETRO	APLICACIÓN
851110	44.4 mm 1-3/4"	Chevrolet Suburban 1500 04-06, Express 1500 07-13 de 6 Birlos, Express 2500 Express Cargo van 2500 02-06, Express 3500 Express Cargo van 3500 02-14 Chevrolet Sonora 00-06, Caliper doble piston Trasero
851330	57.1 mm 2-1/4"	Chrysler 200 12-14, Dodge Avenger 08-14, Caliber 07-12, Cirrus 06-10, Mitsubishi Lancer 06-10, Jeep Patriot 07-14, Jeep Compas 07-14, Honda CR-V EXL 02-04, CR-V LX, EX, EXL 05-06, Toyota Corolla CE, Corolla LE 03-10, Corolla S 05-10, Matrix XR, Matrix XR S 04-10 Delantero
851340	38.1 mm 1-1/2"	Honda CR-V 02-06 Trasero.
851470	34.9 mm 1-3/8"	Mitsubishi Lancer Raliant Evolution 05-10, Mitsubishi Eclipse 06-09, Nissan Xtrail 02-10, Altima 02-12, Maxima 04-08, Nissan Rogue 08-11 Trasero
853220	63.5 mm 2-1/2"	Honda Pilot LX, Pilot EXL 03-08, Toyota Camry LE 02-08, Camry XLE 04-08, Solara 05-06, Sienna CE, Sienna LE, Sienna XLE 04-10, Toyota Rav4 06-10 Delantero
853260	50.8 mm 2"	Toyota Yaris Hatch Back, Sedan 04-07 Delantero
853271	32.1 mm 1-17/64"	Toyota Rav4 04-10 Trasero
853940	60.3 mm 2-3/8"	Chevrolet Malibu LX 97-01. Malibu LS V6 97-05. Pontiac Grand Am 99-05, Toyota Rav4 04-07 Delantero
854790	65.9 mm 2-19/32"	Chevrolet C-30, C-35, C-36, C-3500 01-02 Heavy Duty Caliper doble piston, Delantero y Trasero

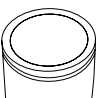



REPUESTO PARA CILINDRO MAESTRO DE CLUTCH

No DE PARTE LUSAC	DIÁMETRO	APLICACIÓN
651	15.8 mm 5/8"	Datsun 66-84 " Ranurado " Superior
660	19.0 mm 3/4"	Cil. Esclavo de Clutch Nissan,Datsun Sedan 70-83,Samurahi 70-84
690	15.8 mm 5/8"	Cil.Mtro. Embrague o Clutch Tipo Nabco Datsun Estaquitas Pick Up 71-83
695	15.8 mm 5/8"	Cil.Mtro. Embrague o Clutch Tipo Tokico Nissan Estaquitas Pick Up 77-84
730	22.2 mm 7/8"	Chrysler Dodge Ram Charger 92-93, D-150,250,350,92-93, Wagoneer 93,Cherokee 93,Microbus 92-93
735	25.4 mm 1"	Chrysler Dodge Ram Charger 92-93, D-150,250,350,92-93, Wagoneer 93,Cherokee 93,Microbus 92-93
840	23.0 mm 29/32"	Chevrolet P-30, P3500, Microbus 92-94
845	20.0 mm	Chevrolet P-30, P3500, Microbus 92-94
850	19.0 mm 3/4"	Chevrolet G.M. Cutlass 90-92 Superior
855	31.7 mm 1-1/4"	Cilindro Esclavo de Embrague Inferior G.M. Celebrity, Century, Cutlass, Citation85-91
860	17.8 mm 45/64"	Chevrolet G.M. Cavalier 93-95 Superior
870	28.5 mm 1-1/8"	Mercedes Benz OM904 05-12, Mercedes Benz OM924 05-12
920	23.0 mm 29/32"	Ford Bronco 88-91, F-150 88-92, F-250 88-92, E-250 90-93, F-350, 88-92Microbus 92-93
925	21.0 mm 53/64"	Ford Bronco 88-91, F-150 88-92, F-250 88-92, E-250 90-93, F-350, 88-92Microbus 92-93
9050	19.0 mm 3/4"	Toyota Corona, Hilux 68-77 Inferior
10990	19.0 mm 3/4"	Toyota Corona 70-73 Land Crusier 69-74 Inferior
19428	26.9 mm 1-1/16"	Ford Cmtas. 57-74 Cmon. Varios 57-74 Superior
19433	26.9 mm 1-1/16"	Ford Cmta. 57-74 P400 69-77 Cmon. Varios 74-82 Incluye Barra de EmpujeSuperior
26127	25.4 mm 1"	Cil. Clutch Esclavo Dodge D-100, D-200, D-300, 57-69,Cmon.Varios 59-77, FordCmtas. T Camiones 57-80 GMC 71-79, F-100, 57-65, F- 250 57-68, F- 300, 57-64, P-400 57-77,Camion 57-76
31081	25.4 mm 1"	Buick 58 Dina Cmon. 66-89
31092	28.5 mm 1-1/8"	Chrysler Dodge D100 59-68, Camión Varios 59-77
33148	28.5 mm 1-1/8"	Chevrolet C10, C20, C30, 60-66 C50, C60, 60-80 Superior
33160	28.5 mm 1-1/8"	Chevrolet C10, C20, C30, C50, C60 60-66
33163	25.4 mm 1"	Chevrolet C10, C20, C30, 60-62 C50, C60 60-61 Inferior Intern. Cmtas. 61-68Camiones 61-76 , Dina Camiones 66-82 Inferior
33254	28.5 mm 1-1/8"	Chrysler Dodge D100 57-68 Cmon. Todos 61-77 Superior
39080	26.9 mm 1-1/16"	Chevrolet C10, C20, C30, 61-66 C50,C60 62-82 Inferior
39148	25.4 mm 1"	Cil. Esclavo Dina Camion 1966-89 Ford 600,700 800 1961-85
40421	20.6 mm 13/16"	Toyota Land Crussier FJA, FJ55 74-86 Inferior
46414	25.4 mm 1"	Bomba de Clutch Sup. Dina Cmon. 66-89, Inter.Cmon 71-80
60002	31.7 mm 1-1/4"	Gm Celebrity, Century, Cutlass, Citation 85-91 Inferior
60051	25.4 mm 1"	Chrysler Ram 1500 94-97, Ram 2500 94-97, Ram 3500 94-97 Inferior
103540	20.6 mm 13/16"	Cil. Mtro. de Embrague Chev.Cmta.C-10,C-20,C-30 85-91, Clutch Secundario
110274	26.9 mm 1-1/16"	Cilindro Maestro de Embrague Superior G.M. C-10 90-91, C-20,25 C-30,350 90-91 Chev. Cmta C-10, C-20, C-30, 85-91,
310990	28.5 mm 1-1/8"	Chrysler Dodge D700, 800 900 61-77 Inferior

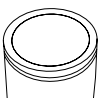



REPUESTO PARA CILINDRO MAESTRO		
No DE PARTE LUSAC	DIÁMETRO	APLICACIÓN
130	17.4 mm 11/16"	VW Sedan 66-91.
151	20.5 mm	VW Combi-Panel 73,88
152	23.8 mm 15/16"	VW Combi-Panel 88-01
170	19.0 mm 3/4"	V.W. Brasilia 74-82, Safari 71-73
180	19.0 mm 3/4"	V.W. Brasilia 74-82
190	19.0 mm 3/4"	V.W. Safari 74-77
191	20.6 mm 13/16"	Volkswagen Corsar 85-86 y Corsar Variant 85-86
193	20.6 mm 13/16"	V.W. Golf GTI A-3 93-98, Jetta CL, GL A-3 93-99, Jetta GLS y Europa A-3 93-98
194	20.6 mm 13/16"	V.W. Golf A-2 C, CL, GL 87-92, Golf GTI A2 89-90, Jetta A2 87-91 Jetta A3 CL, GL, 97-99 para CilMtro Ate
195	17.4 mm 11/16"	VW Caribe 77-79
196	20.6 mm 13/16"	VW Atlantic 81-87, Cilindro Fag y Ate, Caribe 78-87, Cilindro Fag y Ate, Caribe GTI 83-86, Cilindro Fagy Ate, Corsar 83-84, Cilindro Fag y Ate
197	20.6 mm 13/16"	VW Caribe GTI 83-86, Corsar 83-84, Atlantic 81-87, Caribe 78-87 Cil Mtro y Caliper Ate
430	19.0 mm 3/4"	Renault R-8 66-69
460	19.0 mm 3/4"	Renault R-8 70-75, R-10 70-75
470	19.0 mm 3/4"	Renault R-12 72-84
471	21.0 mm 53/64"	Renault Alliance 84-86, Encore 85-86
475	19.0 mm 3/4"	Renault R-12 Vagoneta 72-84
476	19.0 mm 3/4"	Renault R-18 80.84 Bomba Ate
480	22.0 mm	Renault Dauphine 58-69, R4-L 70-76
490	19.0 mm 3/4"	Renault R5 y TL 76-85
630	22.2 mm 7/8"	Datsun 64-68
635	19.0 mm 3/4"	Datsun Sedan P/ Cil Nabco 70-73
637	19.0 mm 3/4"	Datsun Sedan P/ Cil Tokico 70-73
670	19.0 mm 3/4"	Datsun Sedan P/ Cil Nabco 73-82
680	19.0 mm 3/4"	Datsun Sedan P/ Cil Tokico 73-82
681	19.0 mm 3/4"	Nissan Hikari 88-92, Samurai 83-84, Tsuru I 84-87, Tsuru II 88-92, (Cilindro Tokico)
686	22.2 mm 7/8"	Nissan Camioneta Estaquitas 87-03 Pick Up Doble Cabina 82-90 Datsun Sedan 81-84, Sakura 82,(Cilindro Nabco)
687	22.2 mm 7/8"	Nissan Sakura 82, Estaquitas Pick Up 87-03, Datsun Sedan 81-84 (Cilindro Tokico)
688	19.0 mm 3/4"	Nissan Hikari 88-92, Ninja Turbo 86-87, Samurai 81-82, y 84-87, Tsuru I 84-87, Tsuru II 88-92 (Cilindro Nabco)
691	23.8 mm 15/16"	Nissan Ichi Van 87-94
693	19.0 mm 3/4"	Nissan Tsuru III GS 93-14
694	20.6 mm 13/16"	Nissan Sentra 1.6 Lts 96-00 sin ABS Tokico, Tsubame 93-96.
830	20.6 mm 13/16"	Chevrolet Chevy Joy, Swing 94-03, Chevy Monza 97-03, Chevy Pop 94-03, Chevy Vagoneta 00-03,Chevy Pick Up 99.
1486	24.0 & 36.0 mm	Chevrolet S-10 90-91
1737	28.5 mm 1-1/8"	Chrysler Ram 1500 94, Ram 2500 91-94, Ram Club Cab 91-93, Chevrolet Blazer Nevada 92-94,Suburban 88-94, C15 94, C-20, 25 88-91, C-20, C-25 y Cheyene 92-94.
1831	24.0 mm	Chevrolet Century 94-96, Cutlass 94-96, Cutlass Eurosport 94-96.
2720	20.6 mm 13/16"	Chrysler Atos 01, 1/2 rep para cilindro maestro con 2 conexiones y piston secundario ranurado
2726	20.6 mm 13/16"	Chrysler Atos 01-07
3613	31.7 mm 1-1/4"	Chrysler Dodge Camioneta D-100, D-150, D-200, D-250, D-300, D-250 57-58. I.H.C Camión Serie1600, 1700, 1800 50-82. Ford Camión P-350, P-400 61-66, Ford Camioneta F-250, F-350 46-56
3622	38.1 mm 1-1/2"	I.H.C Camión 41-69, Mack 46-63, Red 46-62.
3626	25.4 mm 1"	Chevrolet Early 40-56 Chevrolet Autos 35-52 Cmta. 38-50 Corvette 53-62
3631	28.5 mm 1-1/8"	Chevrolet Camión Serie 120 50-62, Dina Camioneta 78-80, Ford Camioneta 67-68, VAM Classic 41-54,Ford Montacargas Eaton, Yale y Town 70-85 USA
3649	38.1 mm 1-1/2"	Chrysler Dodge Camioneta 300 al 700 57-58, 500, 600 1957-58 700, 800, 1941-58
5375	26.9 mm 1-1/16"	Ford 39-48 Cmta. 1939-56, Ford Camión 3/4 1 Ton. 53-56
9953	25.4 mm 1"	Ford Explorer XLS V6, XLT V8, Limited 91-94.
11300	25.4 mm 1"	VAM Classic 55-57, American 58-61
11301	25.4 mm 1"	Inter. 100, 1954-57 Packard 1951-56 Hudson 1948-57
13504	28.5 mm 1-1/8"	Chrysler Dodge 1946-56, Plymouth 1942-54
13621	28.5 mm 1-1/8"	Chevrolet Camión Serie 3100 Al 3800 55-69, C-10 51-59, C-20, C-30 53-59
13634	25.4 mm 1"	Ford 52-66, Mustang 64-66, VAM Classic 58-59, Ford 52-66, Mustang 64-66, VAM American Classic58-59
19356	25.4 mm 1"	Chevrolet Camión Pasajeros 55-58.





REPUESTO PARA CILINDRO MAESTRO

No DE PARTE LUSAC	DIÁMETRO	APLICACIÓN
19430	31.7 mm 1-1/4"	Chrysler Dodge Camioneta D-300, D-350 57-63 Ford B,F-500 70-77 con Booster
19431	44.4 mm 1-3/4"	Chrysler Dodge 700, 800 1959-76, Ford Camión F-700 68-72, F-500 70-72 USA
19432	38.1 mm 1-1/2"	Chrysler Dodge 500,600, 59-77; D-700, 800 59-71; Ford F-500 73-77; F-600, 700 61-76, B,F-500 70-77
31066	25.4 mm 1"	VAM American, Classic 61, Chevrolet Varios 59-66
331080	25.4 mm 1"	VAM American Classic 1960-61 Jeep 1963-66
31087	25.4 mm 1"	Chevrolet 1959-63
33118	19.0 mm 3/4"	VW Camioneta Hormiga 76-78
33158	25.4 mm 1"	Chrysler Barracuda, Coronet, Dart, Super Bee 65-66
33192	25.4 mm 1"	Ford Camión E-100 61-66 .
33252	25.4 mm 1"	Ford F.P. 100 1961-66 F.250 1966
39142	25.4 mm 1"	Chrysler Dodge Dart Valiant 1960-66 Incluye Barra de Empuje
39650	31.7 mm 1-1/4"	Chevrolet Maxicab 91-93, C-15 95-99 C-20/25 y Cheyenne 95-01, C30,35 88-94, Chrysler Ram 15002X2, 4X4 97, Ram 2500 y Club Cab 2X2, 4X4 (7,500 Lb) 95-97, Ram 2500 94-96,
59012	38.1 mm 1-1/2"	Chevrolet C40 70-72, C50 70-82, C60 70-82, C65 79-82,.
59036	25.4 mm 1"	Ford F100 1967
59070	25.4 mm 1"	Chevrolet Chevelle 70-72, Opel 70-72, Chevelle Malibu 70-72
59092	28.5 mm 1-1/8"	Chevrolet C20, C30, 1967-71 Chev. Varios 68-74
59182	25.4 mm 1"	Ford Mustang 71-73
59193	28.5 mm 1-1/8"	Chrysler D-300 71-74, Dodge D-300 70, Tambor en las 4 Ruedas.
71502	28.5 mm 1-1/8"	Ford Camioneta F-350 70-71 sin Booster
71505	28.5 mm 1-1/8"	Ford F-350 71-72, P350 72-76.
71506	25.4 mm 1"	Ford Camionetas F-100 68-72
71590	25.4 mm 1"	Ford Galaxie 70-72 Mustang 70-77 Incluye Barra de Empuje
71596	28.5 mm 1-1/8"	Chevrolet Chevelle 70, C-10 71 , Impala 70, Chevy Nova 73-74
71621	28.5 mm 1-1/8"	Jeep Wagonner J-164 74-76.
71666	26.1 mm 1-1/32"	Chrysler Super Bee 71-75. Monaco 71-73. D-100 72-73, Dart 71-76, Valiant Duster 71-72. (Rin 14 ") Valiant Duster 73-76. Tambor Delantero y Tambor Trasero. Valiant Volare 77-79, Le Baron 78
71685	28.5 mm 1-1/8"	VAM Classic 76 con Booster.
71686	26.9 mm 1-1/16"	VAM Classic sin Booster 76, Gremlin 74-76, Javelin sin Booster 71-73, Pacer sin Booster 76-78, Rally76.
78673	23.8 mm 15/16"	Ford Galaxie 73
79773	23.8 mm 15/16"	Chrysler Dart 71-73, Valiant Duster 71-73 (Rin 13")
79822	31.7 mm 1-1/4"	Dina 3000, 3200 77-80
80265	25.4 mm 1"	Chevrolet Chevelle Guayin 73-75
80267	23.8 mm 15/16"	Chrysler Dart 73-76, Valiant Duster 73-76 Disco Delantero y Tambor Trasero.
80569	28.5 mm 1-1/8"	Chrysler Dodge D-300 72-78, M-300 78.
80582	26.1 mm 1-1/32"	Chrysler Dodge Monaco 74-77, D-100 73-80, D-300 72-78.
80904	25.4 mm 1"	Ford Galaxie 73- 74, LTD 75-78
80907	23.8 mm 15/16"	Ford Maverick 74-77, Mustang 75-78 con Booster.
83075	31.7 mm 1-1/4"	Ford F-200, F-250 73-75, F-350 73-75 USA
83576	25.4 mm 1"	Ford F.P100 73-79 E100 y 150 75-79, F250 73-79
84051	25.4 mm 1"	Chevrolet C-10 74-80 Americana
86131	23.8 mm 15/16"	Ford Mustang 75-78
86508	23.8 mm 15/16"	Ford Maverick 74-77, Mustang 75-78 con Booster.
86511	33.3 mm 1-5/16"	Chevrolet C-30, C-35 76-89 Rodada Doble, C-30, C35 82-83 Rodada Sencilla, Panel P30 82-92 y 97-98.
86626	28.5 mm 1-1/8"	Chrysler Dodge W-250 4 X 4 86-93, D-350, Microbus 81-93.
88631	25.4 mm 1"	Ford F-100 73-79
89036	26.1 mm 1-1/32"	Chrysler Dart 76-78, Le Baron 78. Valian Duster 76 , Valiant Volare 77-78.
90185	26.9 mm 1-1/16"	Ford Mustang GT 94-95
90203	21.0 mm 53/64"	Chrysler Neon 95-96. Disco Tambor sin ABS
90204	22.2 mm 7/8"	Chrysler Neon 95-99 Disco / Disco sin ABS
90215	22.2 mm 7/8"	Chrysler Dodge Neon D/D con ABS 95-99.
90234	23.8 mm 15/16"	Nissan Maxima Nabco S/ABS 95-00, Sentra 1.8 Lts 01-06, Sentra 2.0 Lts 01, Sentra 2.5 Lts 02-06
90251	22.2 mm 7/8"	Chrysler Breeze Rin 14" 96, Cirrus 96-00, Sebring R/T 97, Stratus 95-02 sin ABS,
90271	22.2 mm 7/8"	V.W.Golf A3 CL, GL. 1.8 Lts 93-94, Golf A3 GLS 2.0 Lts 93-94, Golf Cabrio A4 2.0 Lts 02. Golf GTI A393-96, Golf A3 GTI VR6 95-99, Jetta A3 CL, GL, 1.8 Lts 93-96 Jetta GLS A3 2.0 Lts 93, Jetta A3 VR695-99.
90279	31.7 mm 1-1/4"	Chevrolet C-30, C-35 95, C35,C3500, C3500 Hd 96-00, Panel-30 96-00.



REPUESTO PARA CILINDRO MAESTRO		
No DE PARTE LUSAC	DIÁMETRO	APLICACIÓN
90303	25.4 mm 1"	Chrysler Jeep Cherokee 98-01; Jeep Grand Cherokee con ABS 4X2, 4X4 95-98.
90318	22.2 mm 7/8"	Nissan Sentra 2.0 Lts sin ABS 96-00, Tsuru GSR 2000 2.0 Lts 93-96, Lucino GSE, GSR sin ABS 96-00
90337	31.7 mm 1-1/4"	Ford Lincoln Navigator D/D 98-02, Expedition XLT, Eddie Bauer 97-04, F150 00-04, F-250 97-02, F-250 Super Duty 98-02, F-350 95-05, F-350 XL V8 Triton Rodada Doble 99-05, Lobo 00-04; Con C/ de Vel. P350 97.
90386	25.4 mm 1"	Chevrolet Malibu LX, 97-01, Malibu Ls 97-01, Grand Am ABS 99-00.
90398	26.9 mm 1-1/16"	Ford Lincoln Aviator 03-05, Explorer XLS V6, XLT V8, Limited 98-05, Ranger 01-06, Mercury Mountaineer 05 Con C/ de Velocidad.
90426	31.7 mm 1-1/4"	Chrysler Ram Charger 99-01, Ram Runner V-10 97, Ram 1500 97-01, Ram 2500 y Club Cab Larami y Quad Cab 97-01, Ram 3500 98-01. Ram 4000 98-01.
90463	25.4 mm 1"	Ford Mystique 97-00, Contour 96-00 S/ABS.
90516	31.7 mm 1-1/4"	Chrysler Ram Van 1500, Ram Wagon 1500 98-03, Ram Van 2500, Ram Wagon 2500 96-02, Ram-Van 3500, Ram Maxi Wagon 3500 98-02, Town & Country 97-00,
90531	34.9 mm 1-3/8"	Ford F-250 Super Duty 99-06, F-350 99-06, F-450 V10 99-05, F-450 V8 Diesel Super Duty 05-06, F-550 V10 01-04, Super Duty sin C/ de Velocidad
90707	26.9 mm 1-1/16"	Chrysler Voyager 01-04
90711	26.9 mm 1-1/16"	Chrysler Jeep Liberty 02-07
90901	20.6 mm 13/16"	V.W. Pointer 1.8 Lts 98-02 Pointer City 00-02 Pointer Vagoneta 99-02
96404	19.0 mm 3/4"	Cil. Mtro. V.W. Sedan 92-04
96404-LC	19.0 mm 3/4"	V W Sedan 92-04 (Unicamente Aplica para Cil. Mto. LC-96415)
97613	28.5 mm 1-1/8"	Dina 1000 80-81 con Boster Chevrolet C-30,C-35 71, Caprice 78-80, Chevelle 71-75, Chevelle Malibu 70-75, Chevy Nova 75-78, Impala 71-75, C10 72-78. VAM con Boster Wagoner 77-80 Wagoner J-164 74-76, Chevrolet C-10 77-80, Caprice 77-80, Willys Camioneta 77-80. USA
97688	23.8 mm 15/16"	VAM American 77-83, Gremlin 77-83; Pacer 79, Rally 77-83
97935	25.4 mm 1"	Ford F-150 80-86, P-350 77-78
98059	31.7 mm 1-1/4"	Dina 3000, 3200 77-83, Chevrolet C35, C35 71-80. Ford F-350 73-76, P350 76
98509	31.7 mm 1-1/4"	Ford F-350 76,P-350 Microbus 76
98909	25.4 mm 1"	Ford Crown Victoria 81, Grand Marquis 82, LTD 79-80.
99032	23.8 mm 15/16"	Chevrolet Chevelle Malibu 79-81, Monte Carlo 81
99083	26.9 mm 1-1/16"	Ford F-350 77-83, P-350 77-78, Ford Camioneta E-200 86 Ford Camioneta E, F-250, E, F-350 77-83USA
99085	22.2 mm 7/8"	Ford Fairmont, Fairmont Vagoneta 78-81, Mustang 79-81 con Boster
99087	22.2 mm 7/8"	Ford Fairmont, Fairmont Vagoneta 78-83, Mustang 79-81 sin Boster
99984	22.2 mm 7/8"	Chevrolet Celebrity 82-84, Citation 82-86, Century 83-86,
101928	28.5 mm 1-1/8"	Chrysler Dodge D-150 81-93. D-250 86-93, D-300 79-80, D-350 Microbus 81-90, W-150 85-87, RamVan 1500 95, Ram Wagon 1500 95. Ram Charger 86-96, W-250 4 X 4 86-88.
101929	28.5 mm 1-1/8"	Chrysler Dodge D- 150 81-93
103255	38.1 mm 1-1/2"	Ford Camión B-600,F-600 80-85
104459	28.5 mm 1-1/8"	Chevrolet Blazer Nevada 92-94, C15 94, C-20, 25 88-94. Chevrolet Caprice 81-82, Dina Camionetas 1000 81-83, 3000, 3200 80-83 Chevrolet Blazer Nevada 4X2 y 4X4 91 , C15 82-87, C20, C25 79-87, Suburban 87. VAM Wagoner 81-86, Chrysler Ram Runner V-10 96, Ram 1500 95-96, Ram 2500 y Club Cab 95-96, Chevrolet Silverado 95-99, C-15 95-99, C-20 C-25 y Cheyenne 95-01, Sonora 00, Suburban 95-00.
104465	31.7 mm 1-1/4"	Chevrolet Camionetas C, K, R 20, Suburban C-30 81-89 Americana.
104467	25.4 mm 1"	Chevrolet C-15 88-91
104470	22.2 mm 7/8"	Chrysler Dart K 82, Dart K Guayin 82. Volare K 82.
105809	21.0 mm	Ford Fairmont, Fairmont Vagoneta con Booster 82-83
105838	34.0 mm	Chevrolet Microbus 94-00, Panel P30 94-98. (Unicamente Contiene Gomas y Empaques)
106470	25.4 mm 1"	Inetrn. Cmta. 58-60 IH Metro Am 61-80 (USA)
107051	24.0 mm	Chevrolet Pick Up S-10 95, Blazer 95. Montecarlo 83-84, Cutlass Supreme 87-88 USA, T Camioneta C-10 C-15 88-92 USA
107056	24.0 mm	Chevrolet Celebrity Vagoneta 85-86, Celebrity, Century 83-86 (USA)
108657	20.0 mm	Ford Topaz 84-94, Ghia 91-94 Cilindro Tokico
110920	28.5 mm 1-1/8"	Ford F-200 86, F-350 84-86.
112115	21.0 mm 53/64"	Chrysler Dart K 83-88, Dart K Guayin 83-88, Dart E 89, Le Baron K 83-87, Magnum K 83-88, New Yorker 85-99. Phantom 87-89, Serie 600 K 84-85, Shadow 89-94, Volare K 83-88.
112246	24.0 mm	Chrysler Imperial 91, Le Baron 92-95, New York 90-94, Phantom 90-94, Spirit Rt 91-95, Voyager 94-95, Grand Voyager 91-95, Town & Country 93-95,
112312	21.0 mm 53/64"	Ford Cougar 85-86, Grand Marquis 83-84, Mustang 82-84, Thunderbird 85-86
113440	28.5 mm 1-1/8"	Chevrolet Camioneta G-10, G-20, P-25 86-90 USA
113441	31.7 mm 1-1/4"	Chevrolet Cmtas C,P 30/35 Mini-Bus 82-90 (USA)

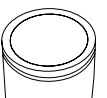



REPUESTO PARA CILINDRO MAESTRO

No DE PARTE LUSAC	DIÁMETRO	APLICACIÓN
114084	26.9 mm 1-1/16"	Ford F-150 S/C/de Velocidad 87-04, F-200 87-91, F-250 92; Econoline Van E 150 95-96; Club Wagon V6 E 150 95-96; Lobo 97-99, Econoline Club Wagon V6 E-150 XL 95-96, F-150 94-04, Lobo 97-99.C/C. Vel.
114085	28.5 mm 1-1/8"	Ford F-250 92-96, F-350 84-94, P-350 89-96, F-200 87-91, Econoline Van E-250 97, Club Wagon V8 E-250 95-96, Club Wagon V8 E-350 95-96, P-350 94-96 C/ Control de Vel Doble Rodada
114191	22.2 mm 7/8"	Chevrolet Cavalier 90-99, Cavalier Z24 91-96, Century 87-89. Sunfire 97-92 y 04-05. Cavalier 2.2 Lts00-04.
114196	24.0 mm	Chevrolet Silhouette 91, Celebrity 87-89, Century 90-93, Cutlass 87-93, Cutlass Eurosport 87-93. Buick Regal 94-96, Chevrolet Lumina Apv 95-96, Silhouette 92-95
116611	23.8 mm 15/16"	Ford Camioneta Ranger 87-89 USA
116612	22.2 mm 7/8"	Chrysler Shadow GTS Turbo 89, Spirit 90-95. Shadow 87-94, Lebaron Coupe Sedan 90-95 Rin 14, 89,Rin 14,15 para MC 39736 USA
120591	31.7 mm 1-1/4"	Chevrolet Camioneta C-30,C-35 91-94, Microbus 92-93 y 97-00.
120795	23.8 mm 15/16"	Ford Thunderbird 89, Taurus Vagoneta 90-91
120797	25.4 mm 1"	Ford Cougar 90-92, Cougar S/ABS 93-95, Cougar XR-7 90-94, Sa-ble Vagoneta 94-95, Taurus 90-91,Thunderbird 90-95.
193800	38.1 mm 1-1/2"	Chevrolet C50 1955-69
331650	31.7 mm 1-1/4"	Chevrolet C50, C60 1960-65
590000	31.7 mm 1-1/4"	Chevrolet C30, 35 70, C40 70-72, C50 73-82.
840550	26.9 mm 1-1/16"	Chrysler Le Baron 1A. Producc. 1o. De Sep. 1977 30 Enero 1978 Chrysler IPM .74-75
903310	23.8 mm 15/16"	Ford Focus LX, SE, ZTS, Wagon 00-06 , Focus ZX3 00-04, Focus STV 02, Con C/ de Tracción
903320	23.8 mm 15/16"	Ford Fiesta 1.4 Lts 98-06, Fiesta Ikon 99-09, Courier Pick Up 01-09 para autos que lleven la balata7259- D649
903330	22.2 mm 7/8"	Ford KA 01-08, KA Sport 04-08
903380	31.7 mm 1-1/4"	Ford F-350 98-04, F-350 Super Duty V-8 98-04
904080	20.6 mm 13/16"	Nissan Platina 02-04, Renault Clio 01-08
904081	23.8 mm 15/16"	Ford Fiesta 1.6 Lts 03-10, Eco Sport 04-10, Fiesta Firts Brasileño 03-10
904086	24.5mm 1"	Nissan Urvan 00-07
904090	34.0mm	Chevrolet Express 1500, 2500 03-07, escalade 03-07.
904092	20.6 mm 13/16"	Pontiac Matiz 04-11
904093	23.8mm 15/16"	Volkswagen Eurovan L-5 2.5 LTS 01-04, Eurovan VR6 2.8 LTS 00-04, Eurovan Diesel 06
113441A	33.3 mm 1-5/16"	Chevrolet Camionetas C30, C35 84-87, Microbus 88-91 y 97-00, Panel P30 82-92 y 97-98.

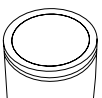



REPUESTO FD		
NO. DE PARTE LUSAC	DIAMETRO	APLICACIÓN
124	48.0 mm 1-57/64"	Chevrolet Chevy Joy 94-03. Chevy Swing 94-03, Chevy Monza 97-03. Chevy Pop 94-03. Chevy Vagoneta 00-03. Chevy Pick Up 99-04 Chevy C2 04-12, Volkswagen Golf A-3 CL, GL. 93-99. Golf A-2 C, CL, GL 87-92. Golf A-3 GLS 93-99. Golf Cabrio A-3 96-99. Golf GTI A-2 89-92. Jetta A-2 87-92. Jetta A-3 CL, GL. 93-99. Corsar 85-88, Corsar Variant 86-88. Derby 95-00, Renault Sandero 10-12, Volkswagen Van 03-09 Delantero
126	54.0 mm 2-1/8"	Volkswagen Combi Panel 73-01. calibrador ATE Delantero
127	40.0 mm	Volkswagen Brasilia 74-82, Sedan 95-04.
128	44.0 mm	Volkswagen Atlantic 81-87, Caribe 77-87, Caribe GT 83-86, Corsar 83-84, Calibrador Girling. Delantero
129	44.0 mm	Volkswagen Atlantic 81-87, Caribe 77-87, Corsar 83-84. Calibrador Ate, Caribe GT 83-86. Delantero
435	32.1 mm 1-17/64"	Renault R-8 66-69 Caliper Trasero
436	38.1 mm 1-1/2"	Renault R-8 66-69 Caliper delantero
439	48.0 mm 1-57/64"	Renault 12 TL, TS 72-84. Delantero
445	45.0 mm	Renault R5 TL 76-85. Delantero
447	48.0 mm 1-57/64"	Renault R-18 80-84. Caliper Tipo Girling. Delantero
640	50.8 mm 2"	Nissan Datsun Sedan 73-84, Sakura 82-84, Estaquitas Pick Up. 72-78. Delantero
641	48.0 mm 1-57/64"	Nissan Hikari 88-92. Ninja Turbo 86-87, Sakura 85-86, Samurai 81-87, Tsuru I 84-87, Tsuru II 88-92, Tsuru III GS 93-14. Tsubame 93-04, Sentra 1.6 Lts. 92. Chevrolet Trail Blazer 4X2 LS, LT, 4X4 02-06 Trasero. Chevrolet Trail Blazer 4X4 EXT. 04-06 Trasero
642	60.3 mm 2-3/8"	Chevrolet HHR 06-08, Chevrolet Malibu 04-12, Mitsubishi Galant 03-09, Mitsubishi Outlander 04-06, Mitsubishi Eclipse 06-12, Nissan Ichi Van 87-94, Estaquitas 72-03. Pick Up D-21 92-03, Pick-Up Doble Cabina 82-00, Pick Up Corto 90-00, Pick -Up King Cab 95-00. Pick-Up Largo 97-03, Pick-Up 250 94-96, Pontiac G6 05-09, Solstice 06-09 Delantero
643	54.0 mm 2-1/8"	Nissan Sentra 1.6 Lts 96-00, Lucino GSE 1.6 Lts 96-00, Mitsubishi Lancer 04-09, Lancer Ralliart 05-06, Lancer DE ABS, Lancer ES 07-08, Suzuki Swift 07-09 Delantero
815	85.7 mm 3-3/8"	Dina Camta. 3000, 3200 75-77. Delantero
1314	80.2 mm 3-5/32"	Chevrolet C-30, 35 79-80. Rodada Sencilla Delantero
1449	54.0 mm 2-1/8"	Chevrolet Meriva 04-08, Fiat Palio Adventure 04-11, Fiat Palio Sedan 04-08 Ford Eco Sport 04-10, Fiesta 98-01 y 03-06, Fiesta Sedan 05-06, Fiesta Sedan First, Fiesta Sedan Trend 07-14, Fiesta Ikon 01-07, KA 01-03, KA Sport 04-08, Courier Pick up 01-10 Del. Para autos que llevan la balata 7259- D649, Mazda Mazda2 12-14, Renault Megane 01-03, Megane II 03-07, Megane II Sedan 04-07, Megane II Coupe Convertible 05-07, Megane II Sport 07, Scenic 01-09, Peugeot Partner 04-08, Seat Alhambra 02-03. Cordoba 01-09. Ibiza 01-09, Toledo 01-06, Seat León Signo 03-04, León Reference 07-10, León Stella 03-04, León Stylace 05-10, León Cupra 05-10, Volkswagen Beetle 1.8, 2.0 98-10, Beetle Turbo 1.8L 00-05, Cross Fox 07-11, Derby 01-09, Eurovan VR6 2.8 LTS 00-02, Golf A3 GTI VR6 95-99, Golf GTI A-3 2.0 L S/ABS 99, Golf A4 Cabrio 00-02, Golf GTI A-4 2.0 L S/ABS 00-05, Golf A4 00-10, Golf GTI A4 00-05, Jetta A3 GLS, Jetta A3 Europa 93-99, Jetta VR6 2.8 Lts A-3 95-99. Jetta A4 00-10. Jetta VR6 96-04, Passat 91-93, Passat Vagoneta 91-92, Passat VR6 96-97. Passat y Passat Wagon 96-97, Polo 03-07, Lupo 05-09, Volkswagen Van 03-09 Delantero
1458	57.1 mm 2-1/4"	Chevrolet Geo Tracker 05-08, Honda Accord 4 Cil. 96-12, Nissan Almera Comfort 01-05, Altima 96-12, Maxima 00-14, 240 SX 93-98, Infiniti I-30 00-01, Suzuki Grand Vitara, 06-11, Suzuki SX-4 07-10 Delantero
1473	66.0 mm	Chrysler Jeep Liberty 02-13, Chrysler Jeep Cherokee Sport 94 y 98-01, Jeep Grand Cherokee 93-98, Jeep Wrangler 93-02, Jeep Wrangler Sahara 97-02, Jeep Wrangler Unlimited, Jeep Wrangler Rubicon 03-06, Vam Jeep CJ-5 84-86, Caliper ATE, Vam. Jeep CJ-5 79-86, CJ-7 82-84, Hummer 96-01 USA Delantero
1562	48.0 mm 1-57/64"	Chevrolet Geo Tracker 93-95 y 98-06. Delantero
1565	66.7 mm 2-5/8"	Ford Explorer XLS V6, XLT V8, Limited 91-94, Aerostar 91-95 Nacional, Ford Bronco II 84-90 USA, Ranger 83-94 USA, Mazda Trk. B 94 USA
1595	54.0 mm 2-1/8"	Honda Civic EX, SI 97-10. Delantero
1668	42.8 mm 1-11/16"	Nissan NP300 09-12, Pathfinder XE 97-98. Pick Up D-21 92-10. Pick-Up Doble Cabina 97-10. Pick Up Corto 90-00. Pick -Up King Cab 95-00. Pick-Up Largo 97-10. Pick-Up 250 94-96, Estaquitas Pick Up 72-10 Delantero, Nissan Cta. Frontier 4 cil. 00-04, Urvan 00-01 Delantero caliper Doble piston
1759	38.1 mm 1-1/2"	Chevrolet Buick Regal 94-96. Cadillac Seville 94-97, Seville STS 98-01, Cadillac De Ville 94-99. Cadillac El Dorado 94-97. Trasero. Aztek 01-04. Grand Prix GT, GTP, SE. 97-01, Impala 00-04, Trasero
1776	60.3 mm 2-3/8"	Chrysler Sebring R/T 98-00. USA. Delantero
1785	36.0 mm	V.W. Golf GTI A-2 89-92. Trasero
1800	42.8 mm 1-11/16"	Nissan D21 92-00. USA. Infiniti Q-45 94-96. Delantero Caliper Doble Piston
1837	65.9 mm 2-19/32"	Ford Grand Marquis 95-97. Lincoln Town Car ABS. 95-00. Mustnag GT 98 Delantero

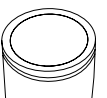



REPUESTO FD		
NO. DE PARTE LUSAC	DIAMETRO	APLICACIÓN
1838	73.0 mm 2-7/8"	Ford F-150 86-89 y 92-93, F-200 2A. Versión 86, Caliper de Un Piston, Ford Club Wagon V6 E-150 95-03. Club Wagon V8 E-250 97-04. Econoline Van E-150 95-07, Econoline Wagon E-350 Diesel 01 y 03, Club Wagon V8 E-350 97-98. F-150 94-99. Delantero.
1930	42.1 mm 1-21/32"	Chevrolet Buick Regal 94-96. Delantero
1962	36.1 mm 1-27/64"	Chrysler Cirrus Sedan 01-05, Concord 01-02, Imperial 91, Intrepid 98-01. Stratus 98-05, 300 M 99-04, Rin 15" y 16", Pt Cruiser 01-08, Pt Cruiser Turbo 03-07, Pt Cruiser Convertible 03-08 Trasero
1966	59.5 mm 2-11/32"	Ford Econoline E-350 Van 99 y 06-07. Econoline E-350 Van Diesel 06-07, Club Wagon V8 E-250 95-96, Club Wagon V8 E-250 Chateau 99-00. Econoline Club Wagon V8 E-350 XL 99-06, Econoline Club Wagon V8 E-350 XL 95-96. Trasero F-450 V8 Super Duty 97-02. Delantero y Trasero Caliper doble piston Cubrepolvo suave
1967	45.0 mm	Ford Freestar 04-07, Thunderbird 90-96 y 03-04, Cougar 90-95, Cougar XR-7 90-94, Taurus 90-91, Lincoln Mark VIII 94-96 Trasero
2005	74.6 mm 2-15/16"	Chevrolet Suburban 88-00, Blazer Nevada 92-94. C-15 94-99, C-20, C-25 y Cheyenne 92-01, C-3500 02-08, G-15 98-01. G-15 Express 1500, Express Cargo Van 1500. 98-01, y 03-06 Doble piston. Express 2500, Express Cargo Van 2500. 99-06, Maxi Cab 91-93, Silverado 1500 95-99, Chrysler RamCharger 99, Ram 1500 94-00, Ram 2500 91-00, Ram Runner V-10 96-97. Delantero Caliper sencillo, Avalanche 02-06. Cadillac De Ville 90-93, 97-99, Cadillac Escalade 02-06. Cadillac Escalade Ext 03-06. Silverado 1500 00-01 y 03-06, Silverado 2500 00-01 y 03-06. Silverado 3500 96-06. Sonora 00-06. Suburban 00-06, G-15 02-05. G-15 Express 1500, Express Cargo Van 1500. 02-06. Express 2500, Express Cargo Van 2500. 02-06. Delantero Caliper doble piston
2020	54.0 mm 2-1/8"	Nissan Lucino GSE 96-00, Lucino GSR 2.0 LTS 96-00. Sentra 1.6 LTS. 96-00; Sentra 2.0 LTS. 96-01; Tsuru GSR 2000 Sin ABS. 93-96, Chrysler Verna 04-06. Delantero
2027	34.0 mm	Nissan Altima 96-01. Infiniti I-30 98-01. Maxima 91-93 y 95-01, 240 SX 93, Honda Civic 06-10, Suzuki SX4 07-10, Suzuki SX-4 07-10 Trasero
2029	57.1 mm 2-1/4"	Chrysler PT Cruiser 01-08, PT Cruiser Turbo Convertible 03-08, Mazda 6i Grand Sport 06-10 Delantero
2033	86.1 mm 3-25/64"	Chrysler Ram 3500 94-99. Ram 4000 95-99. Ram Srt-10 05-06. Chevrolet C-30, 35 90 y 92-00. Panel P-30 98-00, C-35, C-3500 HD 96-00, Panel P-30 01-03 Delantero
2038	69.8 mm 2-3/4"	Chrysler Dodge Durango 98-02 Delantero.
2040	52.0 mm 2-3/64"	Chevrolet Astra 1.8 Lts. 00-03 y 07-08, Chev. Astra 2.0 Lts. 03-06. Astra 2.2 Lts. Elegance 00-04, Astra Vagoneta 01-03, Astra Turbo 07-08, Sin ABS Delantero
2043	54.0 mm 2-1/8"	Chrysler Dodge Durango 03-09 Caliper doble piston Delantero
2045	48.0 mm 1-57/64"	Chrysler Jeep Commander 06-10, Jeep Grand Cherokee 99-10 Delantero. caliper doble piston Teves doble piston, Jeep Commander 06-10, Jeep Grand Cherokee 99-10 Trasero Caliper sencillo
2048	34.0 mm	Seat Ibiza 01-09 C/ABS, Seat Cordoba 01-09 S/ABS, Chevrolet Astra 2.2 LTS. Elegance 00-04. Astra 1.8 LTS. HB Confort 00-08, Astra 2.0 LTS. 03-08, sin/ABS, Renault Scenic 01-09 Trasero cubre polvo suave
2070	48.0 mm 1-57/64"	Ford Explorer 03-05, Ford Explorer Sport 94-95 y 98-03, Ford Ranger 04-07. Caliper doble piston Delantero.
2079	52.0 mm 2-3/64"	Ford Expedition XLT 03-06, Expedition Eddie Bauer 03-06 sin control de vel., Lincoln Navigator 03-06. Trasero
2080	73.0 mm 2-7/8"	Chevrolet Camión Kodiak 96-98 Caliper Doble Piston Delantero y Trasero
2081	44.4 mm 1-3/4"	Ford Excursión 2x4 sin/control de velocidad 01-05 Trasero. Ford Excursión 4x4 sin/control de velocidad 01-05 Ford F-350 Super Duty 00-04 Trasero. Caliper doble piston
2095	34.0 mm	Chevrolet Astra 2.2 LTS. Elegance 00-04. Astra 1.8 LTS. HB Confort 00-08, Astra 2.0 LTS. 03-08, C/ABS Trasero
2103	38.1 mm 1-1/2"	Audi A3 98-13, Audi A4 97-10, Chevrolet Astra 1.8 Lts. HB, Comfort. 00-03 Tras. Astra 2.0 Lts. 03-06 Tras. Astra 2.2 Lts. Elegance 00-04, Peugeot 307 03-07, Peugeot 307 Sedan XR 08-09, Seat Alhambra 02-03. Cordoba 01-09. Ibiza 01-09, Toledo 01-03, Volkswagen. Beetle 98-10, Beetle Turbo 00-10, Beetle Cabriolet Turbo 03-10, Bora 08-10, Eurovan L-5 2.5 LTS. 01-04. Eurovan Vr-6 2.8 LTS. 00-02, Golf Cabrio A4 00-02. Golf GTI A-3 93-98. Golf A3 GTI VR6 95-99. Jetta GLS y Europa A-3 93-99. Jetta VR6 A-3 95-99. Passat 91-93. Passat VR6 96-97. Passat 99-05, Sharan 02-08 Trasero
2105	30.1 mm 1-3/16"	Honda Accord 4 Cil. 96-07, Accord V6 03-07. Trasero
2107	57.1 mm 2-1/4"	Chevrolet G-30 03-05, Express 2500 07-14, Express 3500 02-06, Express Cargo Van 2500 02-14, Express Cargo Van 3500 02-13 Delantero, Hummer H2 05-07 Delantero y trasero, Cadillac DTS 06 Caliper Doble Piston Delantero
2110	80.2 mm 3-5/32"	Chevrolet C-30, 35 88-95. G-30 97-02. Express 3500, Express Cargo Van 3500. 97-02. (8 Birlos) Delantero
2111	44.4 mm 1-3/4"	Chevrolet Suburban 1500 04-06, Express 1500 07-14 de 6 Birlos, Express 2500 Express Cargo van 2500 02-06, Express 3500 Express Cargo van 3500 02-14 Chevrolet Sonora 00-06, Caliper doble piston Trasero



REPUESTO FD		
NO. DE PARTE LUSAC	DIAMETRO	APLICACIÓN
2119	45.0 mm	Chevrolet Trail Blazer 02-06 Delantero. Chevrolet Sonora 00-06 Trasero. Chevrolet Avalanche 4x2 02- 03 Trasero. Chevrolet Avalanche 4x4 02-04 Trasero. Chevrolet Avalanche 4x4 02-04 Tras. Chevrolet Avalanche 4x4 V8 5.3 Lts. 05-06 Trasero. Cadillac Escalade 2x4 5.3 Lts. 02-06 Trasero Cadillac Escalade 4x4 6.0 Lts. 02-06 Trasero Cadillac Escalade EXT 4x4 03-06 Trasero. Chevrolet Suburban 1500 00-04 Caliper doble piston Delantero Cubre polvo duro
2135	64.3 mm 2-17/32"	Honda Odyssey 00-10 Delantero.
2144	30.1 mm 1-3/16"	Nissan Sentra 1.6 Lts 96-00, Sentra 1.8 Lts 01-06, Sentra 2.0 Lts 96-01, Tsuru GSR 2000 93-96Trasero.
2148	46.4 mm 1-53/64"	Nissan X Terra 00-05, X Terra S, X Terra SE 06-07 Delantero
2152	64.0 mm	Chrysler Grand Voyager 01-06, Town & Country 01-07. Voyager 01-08 Delantero Disco Tambor.
2154	55.9 mm 2-13/64"	Chrysler Ram Vam 3500, Ram Wagon 3500 98-02 Ram 4000 00-02 y 05-06, Delantero Caliper DoblePiston.
2159	50.8 mm 2"	Chevrolet Express 1500 07-14 6 Birlos, Silverado 1500 4 X 2 4 X 4 00-01 y 03-13, Silverado 2500 4 X2 4 X 4 00-01 y 03-10, Silverado 3500 4 X 2, 4 X 4 96-05. Silverado 3500 HD 4 X 2, 4 X 4 96-06.Suburban 00-06, Trasero Caliper doble piston, Chevrolet Sonora 00-06, Cheyenne 01-06 Cal. Doble Piston Delantero, Chevrolet Suburban 07-14, Tahoe 07-14, Silverado 1500 07-14, Escalade 07-14, Yukon 07-10 Trasero Caliper sencillo
2183	40.0 mm	Volkswagen Jetta A4 1.8, 2.0 lts. 00-10, Bora 06-10 Trasero.
2215	48.0 mm 1-57/64"	Nissan Aprio 08-10, Platina 02-10, Renault Clio 02-10, Clio Expression 04-10, Clio Energy 07-09Delantero
2216	44.4 mm 1-3/4"	Nissan Cta. X-trail 01-10, Nissan Cta. Pathfinder Xe 99-04 Del. Nissan Cta. Frontier V6 01-04Delantero
2221	57.1 mm 2-1/4"	Honda Accord V6 98-06 Nacional, Odyssey 95-99 USA Delantero
2225	38.1 mm 1-1/2"	Ford Thunderbird 03-04, Lincoln LS 00-06, Jaguar X type 02-07, Jaguar S Type 00-07 Delanterocaliper doble piston
2242	50.8 mm 2"	Ford Freestar 04-06 Delantero
2261	57.1 mm 2-1/4"	Cadillac Catera 97-01 Delantero
2275	45.0 mm	Chevrolet Camaro, Línea Nueva, Pontiac Firebird, Tran Am 98-02 Caliper doble piston Delantero, FordMustang GT 98-04, Caliper doble piston Delantero.
2325	30.1 mm 1-3/16"	Peugeot 206 00-07. Renault Megane I 01-03, Megane II 04-10, Trasero
2390	48.0 mm 1-57/64"	Chevrolet Corsa Sedan 03-08, Corsa 02-08, Tornado 04-11. Delantero
2394	60.3 mm 2-3/8"	Chevrolet Malibu LX 97-01. Malibu LS V6 97-05. Pontiac Grand Am 99-05 Delantero
2470	60.3 mm 2-3/8"	Chrysler Stratus 98-06, Cirrus 01-07 Delantero
2472	57.1 mm 2-1/4"	Chevrolet Astra 1.8 Lts. 00-03 Sin ABS. Chev. Astra 2.0 Lts. 03-08. Astra 2.2 Lts.Elegance 00-04. ConABS, Sentra Vagoneta 1.8 Lts 01-03, Zafira 02-06, Ford Fusión 06-12, Nissan Sentra 08-09, Nissan Sentra XE, Sentra GXE 01-09, Nissan Sentra 07-12 Delantero
2473	54.0 mm 2-1/8"	Chrysler Dodge Durango 03-06 Tras., Durango SLT, Durango Limited 05-06, Ram-1500 03-08Del./Tras., Ram Van 1500, Ram Wagon 1500 02-03, Ram 2500, Ram 2500 Quad Cab 03-04, Aspen07-09, Chrysler Durango 03-09, Ram 1500 01-11, Ram 2500 06-11 Trasero caliper sencillo
2475	46.0 mm 1-13/16"	Chevrolet Blazer 98-01, Trail Blazer 4 X 2 LS, LT. 02-05, Trail Blazer 02-06, doble piston delantero,Chevrolet Sonora 00-06, Chevrolet Avalanche 4x2 02-03, Chevrolet Avalanche 4x4 02-04, Chevrolet Avalanche 4x4 V8 5.3 Lts. 05-06, Cadillac Escalade 2x4 5.3 Lts. 02-06, Cadillac Escalade 4x4 6.0 Lts. 02-06, Cadillac Escalade EXT 4x4 03-06 Trasero caliper doble piston
2476	38.1 mm 1-1/2"	Chevrolet Venture APV 98-04. Pontiac Montana SV6 05-07,Torrent 06 Tras. Pontiac Aztek 01-05 4x4.Tras Chevrolet Impala C/S/ ABS 00-04 Tras Grand Prix GT, GTp, Se. 97-01,Toyota Camry 02-11, Toyota Solara 05-07, Mitsubishi Outlander 04-10 4 cil. 2.4L, Honda Pilot 03-08 Trasero Cubre polvo Suave, Toyota Rav4 Base y Limited 08-10, Camry Tras 07-11 Trasero
2477	48.0 mm 1-57/64"	Ford Lincoln Aviator 03-05, Lincoln Town Car 98-02, Explorer 95-97, Explorer Eddie Bauer 98-09, Explorer Sport 94-03, Ford Explorer XLS V6, XLT V8, Limited s/cont/vel 95-10 Tras. Explorer Sport s/c de tracc, y c/c de tracc. 4x2 94-95 y 98-03, Mercury Mountaineer 05, Jeep Liberty 03-13 Tras, Jeep Wrangler, Jeep Wrangler Sahara, Jeep Wrangler Rubicon 03-06, Jeep Gran Cherokee 95-98 Trasero
2478	60.3 mm 2-3/8"	Nissan Pick Up D-21 92-00. Delantero. Americana Caliper de 1 Pistón USA.
2479	65.9 mm 2-19/32"	Chevrolet Truck C-30, C-35, C-36, 3500 Heavy Duty 01-02 Delantero y Trasero Caliper doble piston
2484	60.3 mm 2-3/8"	Chevrolet Luv 97-05 Delantero
2486	47.6 mm 1-7/8"	Nissan Urvan 00-10, Nissan Quest V6 305 L 04-09, Caliper Doble Piston Delantero
2489	45.0 mm	Chrysler Ram 1500 03-08, Ram 2500, Ram 2500 Quad Cab 01-06, Ram 2500 ST, Ram 2500 QuadCab SLT 07-08, Ram 2500 Quad Cab SLT Diesel 03-07, Ram 2500 Mega Cab Laramie 06-08, Ram 4000 05-08 Trasero
2492	44.0 mm	Ford Windstar GL, LX s/c.de tracc, y c/c de tracc. 95-98 Tras. Windstar LX, SE, SE Limited s/c.detracc, y c/c de tracc. 99-03 Trasero

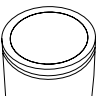



REPUESTO FD		
NO. DE PARTE LUSAC	DIAMETRO	APLICACIÓN
2493	38.1 mm 1-1/2"	Pontiac Gran Am 99-05 Trasero. Cubrepolvo Duro
2496	48.0 mm 1-57/64"	Chevrolet Matiz 04-05, Matiz G2 06-11 Delantero
2500	54.0 mm 2-1/8"	Peugeot 206 00-10, 206 XR 00-10, 206 XT 03-10, 307 03-07, Renault Megane II 05-10, KangooPasajeros 07-10, Renault Scenic 06-09, Trafic Car-ga, Trafic 9 Pasajeros 07-09, Renault KangoExpress 04-10 Delantero
2725	50.8 mm 2"	Chrysler Atos 01-12 Delantero
2730	55.6 mm 2-3/16"	Ford Focus LX, SE, ZTS, Wagon 00-06. Focus ZX3 00-04, Focus SVT 02. Volkswagen
2735	30.1 mm 1-3/16"	Ford Escort 94-01. Escort LX 94-01. Escort Vagoneta 97-99. Escort GT 94-95. Trasero
2769	47.6 mm 1-7/8"	Ford Grand Marquis 92-04. Lincoln Town Car 91-00. Trasero
2776	54.0 mm 2-1/8"	Ford Escort 94-01. Escort LX 94-01, Escort Vagoneta 94-99. Escort GT 94-95. Delantero
2783	38.1 mm 1-1/2"	Nissan Infiniti Q45 94-96. Trasero
2797	54.0 mm 2-1/8"	Ford Lincoln Continental 97-99, Sable 94-04, Sable Vagoneta 94-97, Trasero
2810	54.0 mm 2-1/8"	Ford Focus LX, SE, ZTS, Wagon 00-06. Focus ZX3 00-04, Focus SVT 02. Volkswagen Beetle 98-14, Bora 06-10, Golf A4 07-10, Golf GTI 07-13, Jetta A4 99-09, Jetta A6 11-13, Jetta Clasico 10-14, Delantero Caliper Sencillo, Ford Expedition XLT, Eddie Bauer sin y con/ctrl de velocidad 03-06 Del.. Lincoln Navigator 03-05 Delantero. Caliper Doble Piston.
2813	48.0 mm 1-57/64"	Ford Fiesta 98-06, Fiesta Ikon 01 Delantero para autos que llevan la balata C0175, Mini Cooper 02-06 Delantero
2814	48.0 mm 1-57/64"	Ford Windstar 99-03. Caliper Doble piston Delantero
2815	54.0 mm 2-1/8"	Ford Excursion 4X2 y 4X4 01-05. F-250, F-250 y Super Duty 99-04 Doble piston Delantero F-350 Super Duty 99-04 Ford Triton 99-03. Doble piston Delantero Trasero
2817	48.0 mm 1-57/64"	Ford Grand Marquis 98-04. Lincoln Town Car 98-07 Caliper doble piston, Ford Lobo 97-04, Ford F-150 97-03, F-150 XL 04 Delantero
2820	57.1 mm 2-1/4"	Ford Mondeo Core 01-07. Mondeo Trend 01-07, Mondeo Ghia 01-07 Delantero.
2823	38.1 mm 1-1/2"	Ford Mustang GT 94-04, Cobra 97 Trasero
2826	50.8 mm 2"	Ford Expedition XLT 97-02, Expedition Eddie Bauer 97-02, F-250, F-250 Super Duty 98-02. Lincoln Navigator 98-02. Doble piston Delantero
2827	50.8 mm 2"	Ford F-150 97-99, Ford Lobo 150 Y 250 99-04 s/c vel, Ford F-250 Sup. Duty 4x4 03-04, Ford Lincoln Blackwood 03 Caliper Doble Piston Delantero, Ford Expedition 97-02, F-150 97-04, F-250 97-02, Ford F-250 Sup. Duty 4x4 03-04, Ford Lobo 150 Y 250 97-04, Lincoln Town Car 03-06, Navigator 98-02 Caliper sencillo trasero
2844	60.0 mm	Ford Contour 96-00, Escape 01-10, Mystique 95-00, Mercury Mariner 05-08 Delantero
2845	54.0 mm 2-1/8"	Chrysler Breeze 96. Cirrus 96-00. Cirrus Coupe 99-00. Cirrus Convertible 01-05. Sebring 97. Stratus 95-97, Stratus R-14 95-00, Stratus R-15 96-97. Delantero
2857	46.0 mm 1-13/16"	Ford Explorer XLS V6, XLT V8, Limited. 95-02. Ranger 96-11, Chevrolet Equinox 05-07. Doble piston Delantero
2885	55.9 mm 2-13/64"	Ford Club Wagon V8 E-250 95-96. Club Wagon V8 E-250 Chateau 95-96 y 98-00. Econoline Club Wagon V8 E-350 XL 99-06, Econoline Club Wagon V8 E-350 XL 95-96. Econoline Van E-250 97-99. Econoline Van E-350 98-99 y 06-07. Econoline Van E-350 Diesel 06-07, F-350 95-04. F-250 95-97, P-350 Microbus 94-97. Caliper doble piston Delantero
2901	48.0 mm 1-57/64"	Volkswagen Pointer 98-10. Pointer City 00-10, Pointer Treanline 06-10 Pointer Vagoneta 99-02, Pointer Pick Up 99-07, Gol 10-13, Saveiro 10-13 Delantero
20020	42.0 mm	Chrysler Voyager 01-08 Trasero
20460	47.6 mm 1-7/8"	Chrysler Jeep Commander 06-10, Jeep Grand Cherokee 99-10, Caliper Akebono doble piston Delantero
20930	59.5 mm 2-11/32"	Ford F-450 V10 Super Duty 99-13, F-450 V8 Diesel Super Duty 05-13, F-550 V10 Super Duty 01-13. Del y Tras caliper doble piston Cubrepolvo duro, International CF500 06-13, CF600 06-13 Delantero y trasero
21001	63.5 mm 2-1/2"	Nissan Murano S, Murano SL, Murano SE 04-10 Delantero
21002	45.5 mm	Toyota Tacoma SR5, Tacoma TRD Sport 06-14 Delantero Caliper de 4 pistones
21003	65.9 mm 2-19/32"	Chevrolet Optra 06-10 Trasero.
21004	57.1 mm 2-1/4"	Chevrolet Vectra 4 Cil. 03-08 Delantero
21005	34.1 mm 1-11/32"	Ford Fusion 06-12 Trasero
21007	42.8 mm 1-11/16"	Mitsubishi Outlander Delantero L/N Doble Piston 07-10, Montero Doble Piston 03-09 Delantero
21010	50.8 mm 2"	Chevrolet Express 2500 03-14, Express 3500 02-14 de 8 Birlos Trasero
21013	54.0 mm 2-1/8"	Chevrolet Pontiac G5 Sedan, Sedan LS 07-09, Pontiac G5, Sedan GT, Pontiac Coupe GT 07-09, Pontiac G6 05-09 Delantero
21014	54.0 mm 2-1/8"	Toyota Yaris Hatch Back 06-07, Yaris Sedan 07-14 Delantero
21015	57.1 mm 2-1/4"	Mazda 3 Sedan i 06-14, Mazda 3 Sedan s 06-14, Mazda 3 HB s 06-14, Mazda 5 06-12, Volkswagen Sharan 02-08 Delantero
21016	57.1 mm 2-1/4"	Isuzu ELF 300 08-09, ELF 400 07-11, ELF 450 4 Cilindros Diesel 07-09 Delantero



REPUESTO FD		
NO. DE PARTE LUSAC	DIAMETRO	APLICACIÓN
21017	54.0 mm 2-1/8"	Nissan Tiida 07-13 Delantero
21018	60.0 mm	Volkswagen Eurovan Diesel 06-09 Delantero
21019	65.9 mm 2-19/32"	Toyota Rav4 Del. 06-10 Delantero
21020	48.0 mm 1-57/64"	Chevrolet Trail Blazer 4X2 LS, LT, 4X4 02-06. Trail Blazer 4X4 EXT. 04-06 Trasero Sello grueso paracaliper Delphi, sello delgado para caliper GM, Ford Explorer L/N 06-10 Delantero
21022	54.0 mm 2-1/8"	Ford F-350 Super Duty 05-12, F-350 Super Duty King Ranch 05-12, F-350 Super Duty Lariat 05-12, F-350 Super Duty XL 05-12, F-350 Super Duty XLT 05-12, F-350 Super Duty FX4 08-09 F-350, F-450 Super Duty 11-12 Caliper doble piston Trasero
21023	60.0 mm	Ford F-350 Super Duty 05-12, F-350 Super Duty King Ranch 05-12, F-350 Super Duty Lariat 05-12, F-350 Super Duty XL 05-12, F-350 Super Duty XLT 05-12, F-350 Super Duty FX4 08-09 F-350, F-450 Super Duty 11-12 Caliper doble piston Delantero
21024	54.0 mm 2-1/8"	Ford F-150 06-10, Lobo 06-10 Delantero caliper de 2 pistones
21025	51.0 mm	Ford F-150 06-10, Lobo 06-10 Trasero
21028	45.5 mm	Toyota 4 Runner 03-09 Delantero Caliper de 4 pistones
21030	63.5 mm 2-1/2"	Toyota Camry LE 07-12, Camry XLE 07-12 Delantero
21031	60.3 mm 2-3/8"	Toyota Matrix 09-10 Delantero
21034	54.0 mm 2-1/8"	Chevrolet Pontiac G4 05-06 Delantero
21035	50.8 mm 2"	Isuzu Elf 200 09-12 Delantero
21036	60.3 mm 2-3/8"	Suzuki Gran Vitara 06-12 Disco Disco Delantero
21041	45.5 mm	Honda CR-V 07-11, Odyssey LX 09-10, Mitsubishi Endeavor 04-11 Delantero
21042	60.0 mm	Chrysler H-100 03-10, H 100 Pick up y Chasis Cabina 03-10 Del. Motor a gasolina.
21045	50.8mm 2"	Chevrolet Suburban 07-10, Tahoe 07-14, Silverado 1500 07-14, Silverado 2500 07-10, Escalade 07-10, GMC Yukon 07-14 Delantero Caliper doble piston, GMC Yukon 07-14 Trasero caliper sencillo
21046	52.0mm 2-3/64"	Chevrolet Spark 11-12 Delantero
21047	60.0 mm	Chevrolet Vectra 03-08 delantero
21048	52.0mm 2-3/64"	Nissan Cabstar 08-12, Renault Mascott 06-09, Volkswagen Crafter 5 Toneladas 08-12 Caliper Brembo doble piston cubrepolvo suave Delantero
21049	48.0 mm 1-57/64"	Mercedes Benz Sprinter 315 07-11, Sprinter 316 04-06, Sprinter 415 07-11, Nissan Cabstar 08-12, Volkswagen Crafter 3.5 Toneladas 08-12 Caliper Brembo de doble piston cubre polvo blando caliper Delantero
21051	63.5 mm 2-1/2"	Toyota Solara 05-06, Toyota Sienna CE, Sienna LE, Sienna XLE 04-10, Delantero
21052	45.5 mm	Chevrolet Colorado 04-09 Caliper doble piston Delantero, Canyon 07-08 Delantero, Cadillac CTS 03-07 Del/Tras.
21053	48.0 mm 1-57/64"	Ford Transit 10-12 Delantero, Mercedes Benz Sprinter 315 07-09, Sprinter 316 04-06, Sprinter 415 07-09, Sprinter 3500 07-09, Volkswagen Crafter 3.5 Ton 08-12 Caliper Bosch doble piston Cubre polvo Duro Trasero
21058	54.0 mm 2-1/8"	Chrysler Durango 03-09 Ram 1500 01-05, Ram 2500 01-08 Caliper doble piston Delantero
21059	60.0 mm	Ford F-350 Super Duty XT 12-13, F-350 Super Duty XLT 12-13 caliper doble piston cubrepolvo duro Delantero
21067	54.0 mm 2-1/8"	Chrysler Attitude GL, GLS 06-11, Volkswagen Pointer Vagoneta 99-00 Delantero
21068	54.0 mm 2-1/8"	Chevrolet Aveo 08-14, Optra 06-10 Delantero
21069	38.1 mm 1-1/2"	Chevrolet Malibu 04-12, Pontiac G4 GT 06, G5 GT 07-09, G6 GT y GTP 05-09 Trasero
21072	63.5 mm 2-1/2"	Honda Pilot LX, Pilot EXL 03-08 Delantero
21075	66.7 mm 2-5/8"	Toyota Hiace, carga, largo, corto y pasajeros 06-13 Delantero.
21076	42.8 mm 1-11/16"	Toyota Hilux 04-10 Delantero
21078	57.1 mm 2-1/4"	Chrysler 200 12-14, Dodge Avenger 08-14, Caliber 07-12, Cirrus 06-10, Lancer 06-10, Jeep Patriot 07-14, Jeep Compass 07-14, Mitsubishi Lancer 06-10 5 Birlos, Delantero
21080	66.0 mm	Chrysler Town & Country 01-07, Voyager 01-08 Disco Disco Nacional Caravan 01-07 USA Caliper ATE Delantero
21160	64.0 mm	Pontiac Aztek 01-05 Delantero
21310	33.7mm	Honda Accord V6 98-02 Trasero
21330	57.1 mm 2-1/4"	Honda CR-V EXL 02-04, CR-V LX, EX, EXL 05-08, Toyota Corolla CE, Corolla LE 03-10, Corolla S05-10, Matrix XR, Matrix XR S 04-10 Delantero
21341	38.1 mm 1-1/2"	Honda CR-V 02-06 Trasero
21470	34.9 mm 1-3/8"	Nissan Xtrail 02-10, Altima 02-12, Maxima 04-08 Trasero
21640	38.1 mm 1-1/2"	Nissan Almera 01-05 Trasero
21980	38.1 mm 1-1/2"	Toyota Matrix 09-10 Trasero
21989	45.0mm	Chevrolet Captiva 08-14 Delantero

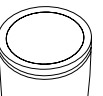



REPUESTO FD		
NO. DE PARTE LUSAC	DIAMETRO	APLICACIÓN
21995	54.0 mm 2-1/8"	Chevrolet Vectra 03-08, Ford Focus SVT 02-03, Focus Europa 07-10, Mazda 3 Sedan i 06-12, Mazda5 06-12 Trasero
21996	57.1 mm 2-1/4"	Ford Focus 07-11, Focus Europa L/N 07-09 Delantero
21998	66.0 mm	Chrysler Dodge Nitro 07-10, Journey 09-11, Wrangler 07-10 Town Country 08-12 Nacional, Caravan 08-10 USA Delantero
23220	63.5 mm 2-1/2"	Toyota Camry LE 02-07, Camry XLE 04-07, Solara 05-06, Sienna CE, Sienna LE, Sienna XLE 04-10, Toyota Rav4 06-10 Delantero
23260	50.8 mm 2"	Toyota Yaris 04-07 Delantero
23270	60.3 mm 2-3/8"	Toyota Rav4 04-07 Delantero
23271	32.1 mm 1-17/64"	Toyota Rav4 Base y Limited 04-07 Trasero
59171	41.3 mm 1-5/8"	Chrysler Dodge Dart 70-73, Valiant Duster 70-73. Delantero
59176	74.6 mm 2-15/16"	Chevrolet Blazer Nevada 91. Caprice 78-82, Chevelle 70-75, Chevelle Malibu 70-75, Chevy Nova 73-78, Impala 70-75, C-10 71-78, C-15 82-87, C-20, 25 79-87. C-30, 35 71-78. G-20 95. Suburban 87-88. VAM Wagoner 77-86. Wagoner J-164 74-76. Dina 1000 77-83, Dina 3000, 3200 77-83. Delantero
59177	69.8 mm 2-3/4"	Chrysler Cordoba 80-82, Dart 76-82, Valiant Duster 76, Le Baron 78-82. Magnum 81-82, Monaco 70-73. D-100 72-73. D-300 72-78. Valiant Volare 77-81, Chrysler Coronet 71-74, Super Bee 70-80, VAM American 74-76, Rally 71-75, Ford Galaxie 70-74, Vam. Classic 74-75, Gremlin 76-83 Caliper Kh, Javelin 71-73. Delantero
59178	60.3 mm 2-3/8"	Ford Mustang 71-73. Delantero
76090	73.0 mm 2-7/8"	Ford F- 100 73-79, F-150 84-85 y 90-91, P-350 Microbus 77-78. Caliper de Un Piston. Delantero
76092	78.6 mm 3-3/32"	VAM Classic 76, Gremlin 74-83. Con Caliper Bendix, Pacer 76-79, Rally 73-75. Jeep CJ-5 78. Caliper Bendix. Delantero
76390	78.6 mm 3-3/32"	Chrysler M-300 80, Ford Ltd 75-78 Delantero.
80926	78.6 mm 3-3/32"	Chrysler Dodge Monaco Volare 74-77. D100, 73-80, D300 1973-77. Delantero USA
83297	85.7 mm 3-3/8"	Chevrolet C-30, 35 71-89 y 96-00, Microbus 88-00, Panel 30 82-98. Delantero (C-30, C35 96-00 Trasero)
83691	65.9 mm 2-19/32"	Chrysler Dart 73-76, Valiant Duster 73-76, Ford Maverick 74-77. Mustang 74-78, Ford F-150 80-83, Ford Lincoln Continental 97-99, Lincoln Mark VIII 94-96, Sable 94-04. Sable Vagoneta 94-97. Windstar GL, LX 95-98, VAM American 77-83, Classic 76 Sin Boster, Rally 76-83, Jeep CJ-5 78, Delantero.
98948	73.0 mm 2-7/8"	Ford Crown Victoria 81, Gran Marquis 82-84 y 92-94, Lincoln Town Car 91-94, Ford Ltd 79-80. Delantero
99024	63.5 mm 2-1/2"	Chevrolet Cadillac Seville 94-97, Seville STS 98-04, Cadillac DeVille 97-04, Grand Prix GT, GTp, Se. 97-01, Impala 00-04, Venture APV 97-04, Pontiac Montana 05-09, Pontiac Torrent 06, Venture APV 97-04, Uplander 05-09, Chevrolet Bonneville 94-99, Cadillac De Ville Concours 94-96, Cadillac De Ville 91-96., Cadillac El Dorado 94-96, Camaro 95-97, Cadillac Seville 94-97, Lumina APV 95-96, Firebird Trans Am 94-97, Oldsmobile 88 92 y 94-95, Silhouette 91-92 y 94-95, Chevrolet Blazer 95-97, Chevelle Malibu 79-81. Monte. Carlo 81-84, Century 83-96, Cutlass 90-96, Cutlas Eurosport 90-96, S-10 Pick Up 95-04, Chevrolet Uplander 05-09, Pontiac Montana 05-07 Delantero
99079	60.0 mm	Ford Cougar 85-88, 93-95. Cougar XR-7 90-94, Fairmont 78-83, Mustang 79-84, Thunderbird 85-88 y 93-96. Cubre Polvo Blando. Delantero
100797	57.1 mm 2-1/4"	Chevrolet Cavalier 92-04, Cavalier Z-24 92-96, Sunfire 97-02 y 04-05, Chevrolet Cavalier 90-91. Cavalier Z-24 91. Celebrity 82-89, Citation 82-86, Cutlass 87-89, Cutlass Eurosport 87-89. Delantero.
101491	78.6 mm 3-3/32"	Chrysler Monaco 74-77. D-100 73-80. D-150 81-93, D-250 86-93, D-300 72-80, D-350 81-93, Microbus 81-93, M-300 78, W-150 85-87, W-250 4X4 86-93, Chrysler M-300 78, Ram Charger 86-96, Ram Van 1500 95-97. Ram Wagon 1500 95-97. Ram Van 2500 96-97. Ram Wagon 2500 96-97. Ram Van 3500 96-97. Ram Wagon 3500 96-97. Delantero.
102443	54.0 mm 2-1/8"	Chrysler Dart "K" y Guayin 82-88, Dart "E" 89, Le Baron "K" 83-87, Magnum "K" 83-88, Neon 95-05. New Yorker 85-89, Phantom 87-89, Serie 600 "K" 84-85, Shadow 89-94, Shadow GTS Turbo 89, Spirit 90-95, Volare "K" 82-88, Delantero caliper sencillo, Ram Van 1500 98-03, Ram Wagon 1500 98-03, Ram 1500 01-08, Ram 2500 01-04, Ram Van 2500 98-02, Ram Wagon 2500 98-02, Ram Charger 00-01. Delantero Caliper Doble piston, Volkswagen Pointer 98-10. Pointer City 00-10. Pointer MI 2.0 Lts. 03-04, Pointer GTI 00-02, Pointer Vagoneta 99-04. Delantero.
103299	69.8 mm 2-3/4"	Chrysler Cordoba 82, Valiant Duster 76, Valiant Volare 80-81, Le Baron 81-82 Delantero.
108241	60.0 mm	Chrysler Concorde 93-97 Y 01-02, Imperial 91, Intrepid 94-01, Le Baron 92-95, New Yorker 90-94, New Yorker LH, LHS 94-97, Phantom 90-94, Spirit R/T 91-95, 300 M 99-04, Grand Voyager 91-00, Town & Country 93-00, Voyager 94-00, Ford Ghia 91-94, Topaz 84-94, Nissan Quest Xe 97-02. Delantero, Chrysler Grand Voyager 84-93 Rin 14" USA. Delantero, Ford F-350 13 Caliper doble piston Delantero
118265	34.1 mm 1-11/32"	Chrysler Cirrus 96-05., Cirrus Coupe 99-00., Cirrus Convertible 01-05, Concorde 93-97, Intrepid 94-97, Le Baron 92-95, Neon 95-05, New Yorker 90-97, LHS 94-97, Phantom 90-94, Sebring R/T 97, Shadow GTS y turbo 89, Spirit R/T 91-95, Stratus 96-06, Trasero
04-112486	65.9 mm 2-19/32"	Ford Cougar 90-92. Thunderbird 89-92, Ford Taurus 88-91, Ford Mustang GT 94-97 Delantero.
2024R	40.5 mm 1-19/32"	Nissan 300 ZX 91-96. Delantero
88562D	55.6 mm 2-3/16"	Ford F-200 86-91, F-350 73-92, P-350 76-78 y 89-91. Delantero Caliper doble piston
88562S	55.6 mm 2-3/16"	Ford F-350 76-83. Delantero

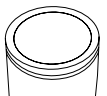

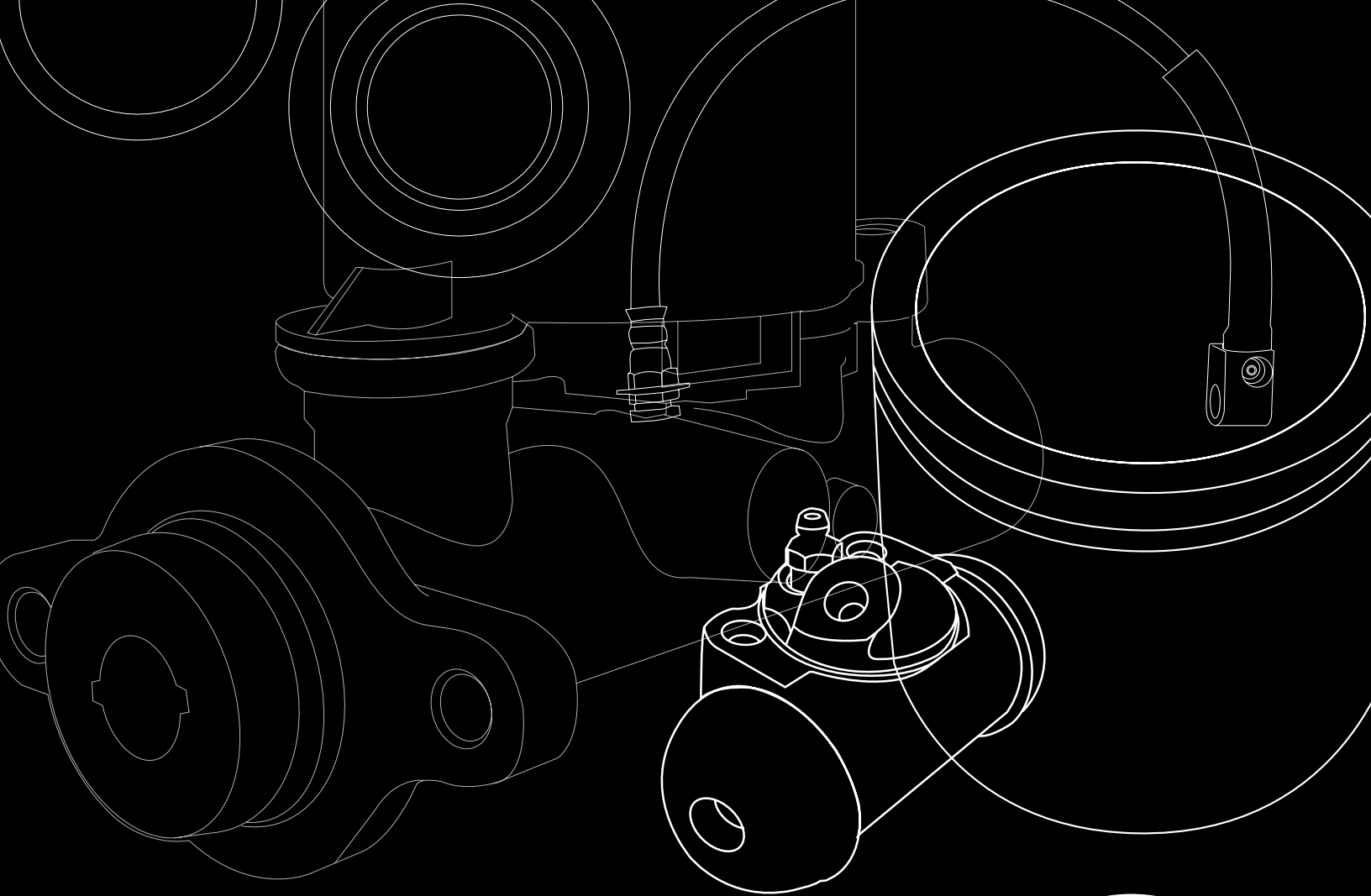

Lusac[®]



Catálogo por número de parte

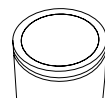



Modelo	Versión	Año	Descripción	Número Lusac	Posición	Diámetro	Notas	Foto Pág.
ACURA								
2.2CL		97-01	CILINDRO DE CLUTCH	37889		19.0 mm 3/4"	CHOCOLATE	
INTEGRA		94-00	CILINDRO DE CLUTCH	360025		19.0 mm 3/4"	CHOCOLATE	
		05-06	MANGUERA DE FRENOS	381586	TRAS DER	14.45"		449
		05-06	MANGUERA DE FRENOS	381587	TRAS IZQ	6.55"		449
		01-02	CILINDRO MAESTRO	390551		26.9 mm 1-1/16"	FABRICADO EN USA	
		07-13	CILINDRO MAESTRO	391004		7/8"	V6, 3.7 LTS	339
		03-06	CILINDRO MAESTRO	391007		1-1/16"	V6, 3.5 LTS	339
		01-02	MANGUERA DE FRENOS	381261	DEL IZQ	17.75"		438
		01-04	MANGUERA DE FRENOS	381586	INT	14.45"		449
		01-04	MANGUERA DE FRENOS	381587	EXT	6.55"		449
RL		05-11	MANGUERA DE FRENOS	382450	DEL DER	22.72"		465
		05-11	MANGUERA DE FRENOS	382450	DEL IZQ	22.72"		465
		12-12	MANGUERA DE FRENOS	382450	DEL IZQ DER	22.72"		465
RSX		02-05	CILINDRO DE CLUTCH	360125		19.0 mm 3/4"		
TL		05-08	MANGUERA DE FRENOS	381499	DEL DER	12.13"		447
		05-08	MANGUERA DE FRENOS	381499	DEL IZQ	12.13"		447
		07-08	MANGUERA DE FRENOS	381544	DEL DER	17.62"		448
		07-08	MANGUERA DE FRENOS	381545	DEL IZQ	17.62"		448
		05-08	MANGUERA DE FRENOS	381550	TRAS DER	17.12"		448
		05-08	MANGUERA DE FRENOS	381551	TRAS IZQ	17.12"		448
	3.2	02-03	CILINDRO MAESTRO	390418		1"	TYPE S	312
	3.2	99-03	MANGUERA DE FRENOS	381025	DER	17.28"		431
	3.2	99-03	MANGUERA DE FRENOS	381026	IZQ	17.28"		431
	3.2	06-06	MANGUERA DE FRENOS	381499	DEL DER	12.13"		447
	3.2	04-06	MANGUERA DE FRENOS	381550	DER	17.12"		448
3.2	04-06	MANGUERA DE FRENOS	381551	IZQ	17.12"		448	
TSX		09-13	MANGUERA DE FRENOS	382554	DEL DER	20.5"		472
		09-13	MANGUERA DE FRENOS	382555	DEL IZQ	20.5"		472
		04-05	CILINDRO DE CLUTCH	360125		19.0 mm 3/4"	CHOCOLATE	
		14-14	CILINDRO MAESTRO	391101		13/16"		342
		09-13	CILINDRO MAESTRO	391101		13/16"	4CIL 2.4 LTS	342
		14-14	MANGUERA DE FRENOS	382554	DER	20.5"		472
		14-14	MANGUERA DE FRENOS	382555	IZQ	20.5"		472
ZDX		10-13	CILINDRO MAESTRO	391004		7/8"	V6, 3.7 LTS	339
AUDI								
A1		11-13	PISTÓN FRENO DE DISCO	85810	DEL	54.0 mm 2-1/8"		526
A3		04-12	MANGUERA DE FRENOS	382497	TRAS DER	10.08"		467
		04-12	MANGUERA DE FRENOS	382497	TRAS IZQ	10.08"		467
		98-14	PISTÓN FRENO DE DISCO	85810	DEL	54.0 mm 2-1/8"		526
		98-14	REPUESTO FRENO DE DISCO	2103	TRAS	38.1 mm 1-1/2"		539
		02-03	CILINDRO MAESTRO	390500		15/16"	4CIL 1.8 LTS, TURBO	316
		02-03	CILINDRO MAESTRO	390925		15/16"		335
		04-13	CILINDRO MAESTRO	391231		7/8"	TIPO ATE 4CIL 2.0 LTS, TURBO	351
		04-12	CILINDRO MAESTRO	391346		22.2 mm 7/8"	C/CILINDRO BOSCH	
		08-11	CILINDRO MAESTRO	391390		23.8 mm 15/16"	CIL ATE	358
A4		13-13	MANGUERA DE FRENOS	382497	TRAS IZQ	10.08"	DS AWD	467
		97-01	MANGUERA DE FRENOS	381116	DEL DER	12.75"		434
		97-01	MANGUERA DE FRENOS	381116	DEL IZQ	12.75"		434
		02-09	MANGUERA DE FRENOS	381502	DEL DER	13.05"		447
		01-09	MANGUERA DE FRENOS	381502	DEL IZQ	13.05"		447

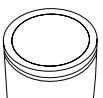



Modelo	Versión	Año	Descripción	Número Lusac	Posición	Diámetro	Notas	Foto Pág.
A4		02-11	PISTÓN FRENO DE DISCO	85392	DEL	66.0 mm		523
		97-11	REPUESTO FRENO DE DISCO	2103	TRAS	38.1 mm 1-1/2"		539
	3.2	96-96	MANGUERA DE FRENOS	380452	INT	8.75"	FWD	420
	3.2	96-96	MANGUERA DE FRENOS	381116	DEL IZQ DER	12.75"		434
	AVANT	98-01	CILINDRO MAESTRO	390613		1"		320
	AVANT	98-01	MANGUERA DE FRENOS	381116	DEL DER	12.75"		434
	AVANT	98-01	MANGUERA DE FRENOS	381116	DEL IZQ	12.75"		434
	AVANT	98-01	REPUESTO FRENO DE DISCO	2103	TRAS	38.1 mm 1-1/2"		539
	CABRIOLET	97-98	MANGUERA DE FRENOS	38027	TRAS IZQ	8.88"		
	QUATTRO	97-01	CILINDRO MAESTRO	390613		1"		320
	QUATTRO	02-09	CILINDRO MAESTRO	390778		1"	CIL GIRLING	327
	QUATTRO	02-09	CILINDRO MAESTRO	391037		1"	CIL ATE	340
	QUATTRO	97-01	MANGUERA DE FRENOS	381116	DEL DER	12.75"		434
	QUATTRO	97-01	MANGUERA DE FRENOS	381116	DEL IZQ	12.75"		434
	QUATTRO	02-09	MANGUERA DE FRENOS	381502	DEL DER	13.05"		447
	QUATTRO	02-09	MANGUERA DE FRENOS	381502	DEL IZQ	13.05"		447
	QUATTRO	02-11	PISTÓN FRENO DE DISCO	85392	DEL	66.0 mm		523
	QUATTRO	97-11	REPUESTO FRENO DE DISCO	2103	TRAS	38.1 mm 1-1/2"		539
		01-01	CILINDRO MAESTRO	390613		1"		320
		02-09	CILINDRO MAESTRO	390778		1"	CIL GIRLING	327
	01-01	CILINDRO MAESTRO	391037		1"	CIL ATE	340	
	06-09	CILINDRO MAESTRO	391037		1"	CIL ATE	340	
A6		98-06	MANGUERA DE FRENOS	381116	DEL DER	12.75"		434
		98-06	MANGUERA DE FRENOS	381116	DEL IZQ	12.75"		434
		98-06	MANGUERA DE FRENOS	381503	TRAS DER	7.82"		447
		98-06	MANGUERA DE FRENOS	381503	TRAS IZQ	7.82"		447
	QUATTRO	98-01	CILINDRO MAESTRO	390613		1"	C/C DE TRACCIÓN	320
	QUATTRO	02-04	CILINDRO MAESTRO	390778		1"		327
	QUATTRO	02-04	CILINDRO MAESTRO	391037		1"		340
	QUATTRO	98-06	MANGUERA DE FRENOS	381116	DEL DER	12.75"		434
	QUATTRO	98-06	MANGUERA DE FRENOS	381116	DEL IZQ	12.75"		434
	QUATTRO	98-06	MANGUERA DE FRENOS	381503	TRAS DER	7.82"		447
	QUATTRO	98-06	MANGUERA DE FRENOS	381503	TRAS IZQ	7.82"		447
		98-01	CILINDRO MAESTRO	390613		1"	C/C DE TRACCIÓN	320
		02-04	CILINDRO MAESTRO	390778		1"		327
	02-04	CILINDRO MAESTRO	391037		1"		340	
A8 A8	QUATTRO	98-10	CILINDRO MAESTRO	390613		1"	C/C DE TRACCIÓN	320
	QUATTRO	98-10	CILINDRO MAESTRO	390778		1"		327
	QUATTRO	04-10	MANGUERA DE FRENOS	380452	TRAS DER	8.75"		420
	QUATTRO	04-10	MANGUERA DE FRENOS	380452	TRAS IZQ	8.75"		420
	QUATTRO	01-10	MANGUERA DE FRENOS	382498	DEL DER	17.62"		467
	QUATTRO	01-10	MANGUERA DE FRENOS	382498	DEL IZQ	17.62"		467
		97-97	CILINDRO MAESTRO	390613		1"	C/C DE TRACCIÓN	320
	97-97	CILINDRO MAESTRO	390778		1"		327	
S3		11-12	PISTÓN FRENO DE DISCO	85810	DEL	54.0 mm 2-1/8"		526
		11-12	REPUESTO FRENO DE DISCO	2810	DEL	54.0 mm 2-1/8"		543
S4		00-01	MANGUERA DE FRENOS	381116	DEL DER	12.75"		434
		00-01	MANGUERA DE FRENOS	381116	DEL IZQ	12.75"		434





Modelo	Versión	Año	Descripción	Número Lusac	Posición	Diámetro	Notas	Foto Pág.
AUDI								
S4		04-05	MANGUERA DE FRENOS	381502	DEL DER	13.05"		447
		04-05	MANGUERA DE FRENOS	381502	DEL IZQ	13.05"		447
		00-01	CILINDRO MAESTRO	390613		1"		320
		02-02	CILINDRO MAESTRO	390778		1"		327
		02-02	MANGUERA DE FRENOS	381116	DEL IZQ DER	12.75"	LOS DÍGITOS 70 Y 80 DEL VIN SON 8D	434
		06-09	MANGUERA DE FRENOS	381502	DEL IZQ DER	13.05"	2 PTAS CON-VERTIBLE	447
	02-02	MANGUERA DE FRENOS	381502	DEL IZQ DER	13.05"	LOS DÍGITOS 70 Y 80 DEL VIN SON 8E	447	
S6	QUATTRO	01-04	CILINDRO MAESTRO	390778		1"	CIL GIRLING	327
	QUATTRO	07-11	CILINDRO MAESTRO	390778		1"	CIL GIRLING	327
	QUATTRO	01-04	CILINDRO MAESTRO	391037		1"	CIL ATE	340
	QUATTRO	01-04	MANGUERA DE FRENOS	381503	TRAS DER	7.82"		447
	QUATTRO	01-04	MANGUERA DE FRENOS	381503	TRAS IZQ	7.82"		447
S8	QUATTRO	01-02	CILINDRO MAESTRO	390613		1"	S/C DE ESTABILIDAD	320
	QUATTRO	07-10	MANGUERA DE FRENOS	380452	TRAS DER	8.75"		420
	QUATTRO	07-10	MANGUERA DE FRENOS	380452	TRAS IZQ	8.75"		420
	QUATTRO	07-10	MANGUERA DE FRENOS	382498	DEL DER	17.62"		467
	QUATTRO	07-10	MANGUERA DE FRENOS	382498	DEL IZQ	17.62"		467
TT	COUPE	00-06	CILINDRO MAESTRO	390500		15/16"	C/C DE ESTABILIDAD	316
	COUPE	00-06	CILINDRO MAESTRO	390500		15/16"	S/C DE ESTABILIDAD	316
	COUPE	00-06	MANGUERA DE FRENOS	381103	TRAS DER	6.58"		433
	COUPE	00-06	MANGUERA DE FRENOS	381103	TRAS IZQ	6.58"		433
	QUATTRO	00-02	CILINDRO MAESTRO	390500		15/16"	S/C DE ESTABILIDAD	316
	QUATTRO	00-02	CILINDRO MAESTRO	390663		15/16"	C/C DE ESTABILIDAD	322
	QUATTRO	00-06	MANGUERA DE FRENOS	381103	TRAS DER	6.58"		433
	QUATTRO	00-06	MANGUERA DE FRENOS	381103	TRAS IZQ	6.58"		433
	ROADSTER	00-02	CILINDRO MAESTRO	390500		15/16"	S/C DE ESTABILIDAD	316
	ROADSTER	00-02	CILINDRO MAESTRO	390663		15/16"	C/C DE ESTABILIDAD	322
	ROADSTER	00-06	MANGUERA DE FRENOS	381103	TRAS DER	6.58"		433
	ROADSTER	00-06	MANGUERA DE FRENOS	381103	TRAS IZQ	6.58"		433
		00-06	CILINDRO MAESTRO	391384		23.8 mm 15/16"	COUPE	
	03-06	CILINDRO MAESTRO	391384		23.8 mm 15/16"	QUATTRO AWD		
BMW								
323I	SERIE 3	98-01	CILINDRO MAESTRO	390923		7/8" 13/16"		335
	SERIE 3	98-01	MANGUERA DE FRENOS	380473	DEL DER	8.75"		421
	SERIE 3	98-01	MANGUERA DE FRENOS	380473	DEL IZQ	8.75"		421
323TI	SERIE 3	99-01	CILINDRO MAESTRO	390923		7/8" 13/16"		335
325I	SERIE 3	95-97	CILINDRO MAESTRO	390239		15/16"		305
325I	SERIE 3	95-97	MANGUERA DE FRENOS	380473	TRAS DER	8.75"		421
	SERIE 3	95-97	MANGUERA DE FRENOS	380473	TRAS IZQ	8.75"		421
	SERIE 3	95-97	MANGUERA DE FRENOS	380538	DEL DER	17.75"		424
	SERIE 3	95-97	MANGUERA DE FRENOS	380538	DEL IZQ	17.75"		424
328I	SERIE 3	96-00	CILINDRO MAESTRO	390479		15/16"		315
	SERIE 3	96-98	MANGUERA DE FRENOS	380473	TRAS DER	8.75"		421
	SERIE 3	96-98	MANGUERA DE FRENOS	380473	TRAS IZQ	8.75"		421
	SERIE 3	96-00	MANGUERA DE FRENOS	380538	DEL DER	17.75"		424
	SERIE 3	96-00	MANGUERA DE FRENOS	380538	DEL IZQ	17.75"		424
525I	SERIE 5	01-03	CILINDRO MAESTRO	390632		1"		320
	SERIE 5	01-03	CILINDRO MAESTRO	390633		1" & 13/16"		320
	SERIE 5	06-07	MANGUERA DE FRENOS	38552	TRAS DER	12.75"		392
	SERIE 5	06-07	MANGUERA DE FRENOS	38552	TRAS IZQ	12.75"		392
	SERIE 5	01-03	MANGUERA DE FRENOS	381510	TRAS DER	12.13"		447
	SERIE 5	01-03	MANGUERA DE FRENOS	381510	TRAS IZQ	12.13"		447

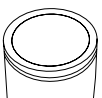



Modelo	Versión	Año	Descripción	Número Lusac	Posición	Diámetro	Notas	Foto Pág.
528I	SERIE 5	98-00	CILINDRO MAESTRO	390632		1"	C/ABS	320
	SERIE 5	98-00	CILINDRO MAESTRO	390633		1" & 13/16"	S/ABS	320
	SERIE 5	96-00	MANGUERA DE FRENOS	381269	DEL DER	17.55"		438
	SERIE 5	96-00	MANGUERA DE FRENOS	381269	DEL IZQ	17.55"		438
			08-10	MANGUERA DE FRENOS	38552	TRAS IZQ DER	12.75"	
530I	SERIE 5	01-03	CILINDRO MAESTRO	390632		1"	C/ABS	320
	SERIE 5	01-03	CILINDRO MAESTRO	390633		1" & 13/16"	S/ABS	320
	SERIE 5	04-07	MANGUERA DE FRENOS	38552	TRAS DER	12.75"		392
	SERIE 5	04-07	MANGUERA DE FRENOS	38552	TRAS IZQ	12.75"		392
	SERIE 5	01-03	MANGUERA DE FRENOS	382499	TRAS DER	12.62"		467
	SERIE 5	01-03	MANGUERA DE FRENOS	382499	TRAS IZQ	12.62"		467
	SERIE 5	10-12	MANGUERA DE FRENOS	38552	DEL DER	12.75"		392
	SERIE 5	10-12	MANGUERA DE FRENOS	38552	DEL IZQ	12.75"		392
	SERIE 5	10-12	MANGUERA DE FRENOS	38552	TRAS DER	12.75"		392
	SERIE 5	10-12	MANGUERA DE FRENOS	38552	TRAS IZQ	12.75"		392
540I	SERIE 5	98-03	CILINDRO MAESTRO	390632		1"	S/ABS	320
	SERIE 5	01-03	CILINDRO MAESTRO	390633		1" & 13/16"	C/ABS	320
	SERIE 5	97-03	MANGUERA DE FRENOS	381269	DEL DER	17.55"		438
	SERIE 5	97-03	MANGUERA DE FRENOS	381269	DEL IZQ	17.55"		438
545I		04-05	MANGUERA DE FRENOS	38552	TRAS IZQ DER	12.75"		392
550I	SERIE 5	06-10	MANGUERA DE FRENOS	38552	TRAS DER	12.75"		392
	SERIE 5	06-10	MANGUERA DE FRENOS	38552	TRAS IZQ	12.75"		392
645CI	SERIE 6	05-05	MANGUERA DE FRENOS	38552	TRAS DER	12.75"		392
	SERIE 6	05-05	MANGUERA DE FRENOS	38552	TRAS IZQ	12.75"		392
650CI	SERIE 6	06-09	MANGUERA DE FRENOS	38552	TRAS DER	12.75"		392
	SERIE 6	06-09	MANGUERA DE FRENOS	38552	TRAS IZQ	12.75"		392
650I	SERIE 6	08-12	MANGUERA DE FRENOS	38552	TRAS DER	12.75"		392
	SERIE 6	08-12	MANGUERA DE FRENOS	38552	TRAS IZQ	12.75"		392
740I	SERIE 7	99-01	CILINDRO MAESTRO	390633		1" & 13/16"		320
	SERIE 7	97-01	MANGUERA DE FRENOS	380565	TRAS IZQ DER	26.25"		426
740IL	SERIE 7	98-01	CILINDRO MAESTRO	390633		1" & 13/16"		320
	SERIE 7	98-01	MANGUERA DE FRENOS	380565	TRAS DER	26.25"		426
	SERIE 7	98-01	MANGUERA DE FRENOS	380565	TRAS IZQ	26.25"		426
745I	SERIE 7	02-05	MANGUERA DE FRENOS	38552	TRAS DER	12.75"		392
	SERIE 7	02-05	MANGUERA DE FRENOS	38552	TRAS IZQ	12.75"		392
745LI	SERIE 7	03-05	MANGUERA DE FRENOS	38552	TRAS DER	12.75"		392
	SERIE 7	03-05	MANGUERA DE FRENOS	38552	TRAS IZQ	12.75"		392
750I	SERIE 7	06-08	MANGUERA DE FRENOS	38552	TRAS DER	12.75"		392
	SERIE 7	06-08	MANGUERA DE FRENOS	38552	TRAS IZQ	12.75"		392
750IL	SERIE 7	98-98	CILINDRO MAESTRO	390632		1"		320
	SERIE 7	99-01	CILINDRO MAESTRO	390633		1" & 13/16"		320
	SERIE 7	95-01	MANGUERA DE FRENOS	380565	TRAS DER	26.25"		426
	SERIE 7	95-01	MANGUERA DE FRENOS	380565	TRAS IZQ	26.25"		426
750LI	SERIE 7	06-08	MANGUERA DE FRENOS	38552	TRAS DER	12.75"		392
	SERIE 7	06-08	MANGUERA DE FRENOS	38552	TRAS IZQ	12.75"		392
760IL	SERIE 7	03-04	MANGUERA DE FRENOS	38552	TRAS DER	12.75"		392
	SERIE 7	03-04	MANGUERA DE FRENOS	38552	TRAS IZQ	12.75"		392
760LI	SERIE 7	05-08	MANGUERA DE FRENOS	38552	TRAS DER	12.75"		392
	SERIE 7	05-08	MANGUERA DE FRENOS	38552	TRAS IZQ	12.75"		392
M3	SERIE M	95-99	CILINDRO MAESTRO	390244		1" & 13/16"		305
	SERIE M	95-99	MANGUERA DE FRENOS	380476	DEL DER	18.75"		422
	SERIE M	95-99	MANGUERA DE FRENOS	380476	DEL IZQ	18.75"		422





Modelo	Versión	Año	Descripción	Número Lusac	Posición	Diámetro	Notas	Foto Pág.
BMW								
M3	SERIE M	01-06	MANGUERA DE FRENOS	382502	DEL DER	18.38"		467
	SERIE M	01-06	MANGUERA DE FRENOS	382502	DEL IZQ	18.38"		467
M5	SERIE M	99-00	CILINDRO MAESTRO	390633		1" & 13/16"		320
	SERIE M	02-03	CILINDRO MAESTRO	390633		1" & 13/16"		320
	SERIE M	06-11	MANGUERA DE FRENOS	38552	TRAS DER	12.75"		392
	SERIE M	06-11	MANGUERA DE FRENOS	38552	TRAS IZQ	12.75"		392
	SERIE M	02-03	MANGUERA DE FRENOS	381269	DEL DER	17.55"		438
	SERIE M	02-03	MANGUERA DE FRENOS	381269	DEL IZQ	17.55"		438
	SERIE M	02-03	MANGUERA DE FRENOS	381269	DEL IZQ	17.55"		438
M6	SERIE M	06-11	MANGUERA DE FRENOS	38552	TRAS DER	12.75"		392
	SERIE M	06-11	MANGUERA DE FRENOS	38552	TRAS IZQ	12.75"		392
X3	SERIE X	04-10	MANGUERA DE FRENOS	382503	DEL DER	21.69"		468
	SERIE X	04-10	MANGUERA DE FRENOS	382503	DEL IZQ	21.69"		468
	SERIE X	04-10	MANGUERA DE FRENOS	382504	TRAS DER	21.31"		468
	SERIE X	04-10	MANGUERA DE FRENOS	382504	TRAS IZQ	21.31"		468
X5	SERIE X	00-01	CILINDRO MAESTRO	390633		1" & 13/16"		320
	SERIE X	02-08	CILINDRO MAESTRO	390768		1" & 7/8"		327
	SERIE X	07-14	MANGUERA DE FRENOS	382505	TRAS IZQ	9.06"		468
	SERIE X	07-14	MANGUERA DE FRENOS	382506	TRAS DER	10.62"		468
X6	ACTIVE-HYBRID	08-08	MANGUERA DE FRENOS	382505	IZQ INT	9.06"		468
	ACTIVE-HYBRID	08-08	MANGUERA DE FRENOS	382506	DER INT	10.62"		468
	SERIE X	09-14	MANGUERA DE FRENOS	382505	TRAS IZQ	9.06"		468
	SERIE X	09-14	MANGUERA DE FRENOS	382506	TRAS DER	10.62"		468
Z3	SERIE Z	96-02	CILINDRO MAESTRO	390479		15/16"		315
	SERIE Z	98-02	MANGUERA DE FRENOS	380476	DEL DER	18.75"		422
	SERIE Z	98-02	MANGUERA DE FRENOS	380476	DEL IZQ	18.75"		422
	SERIE Z	96-02	MANGUERA DE FRENOS	380538	DEL DER	17.75"		424
	SERIE Z	96-02	MANGUERA DE FRENOS	380538	DEL IZQ	17.75"		424
	SERIE Z	96-97	MANGUERA DE FRENOS	381264	TRAS DER	9.68"		438
	SERIE Z	96-97	MANGUERA DE FRENOS	381264	TRAS IZQ	9.68"		438
Z4	SERIE Z	03-09	MANGUERA DE FRENOS	380538	DEL DER	17.75"		424
	SERIE Z	03-09	MANGUERA DE FRENOS	380538	DEL IZQ	17.75"		424
	SERIE Z	03-09	MANGUERA DE FRENOS	382620	TRAS IZQ	17.25"		477
	SERIE Z	03-09	MANGUERA DE FRENOS	382621	TRAS DER	9.19"		477
Z8	SERIE Z	01-03	MANGUERA DE FRENOS	380565	TRAS DER	26.25"		426
	SERIE Z	01-03	MANGUERA DE FRENOS	380565	TRAS IZQ	26.25"		426
BUICK								
CENTURY		83-96	MANGUERA DE FRENOS	2025	TRAS DER	8"		385
		83-96	MANGUERA DE FRENOS	2025	TRAS IZQ	8"		385
		83-86	MANGUERA DE FRENOS	4050	DEL DER	16"		385
		83-96	MANGUERA DE FRENOS	4051	DEL IZQ	16 1/16"		386
		87-96	MANGUERA DE FRENOS	4068	DEL DER	17 5/8"		386
		83-96	PISTÓN FRENO DE DISCO	76033	DEL	63.5 mm 2-1/2"		518
		83-86	REPUESTO FRENO DE DISCO	99024	DEL	63.5 mm 2-1/2"		553
		90-96	REPUESTO FRENO DE DISCO	99024	DEL	63.5 mm 2-1/2"		553
		87-89	REPUESTO FRENO DE DISCO	99024	DEL	63.5 mm 2-1/2"		553
		85-91	CILINDRO DE CLUTCH	360002	INF	31.7 mm 1-1/4"		
		83-89	CILINDRO DE RUEDA	104384	DER	17.4 mm 11/16"		372
		92-93	CILINDRO DE RUEDA	104384	DER	17.4 mm 11/16"		372
		83-89	CILINDRO DE RUEDA	104384	IZQ	17.4 mm 11/16"		372
		92-93	CILINDRO DE RUEDA	104384	IZQ	17.4 mm 11/16"		372

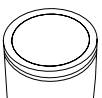



Modelo	Versión	Año	Descripción	Número Lusac	Posición	Diámetro	Notas	Foto Pág.
CENTURY		94-96	CILINDRO DE RUEDA	112341	DER	22.2 mm 7/8"		373
		94-96	CILINDRO DE RUEDA	112341	IZQ	22.2 mm 7/8"		373
		90-91	CILINDRO DE RUEDA	0116366	DER	17.4 mm 11/16"		373
		90-91	CILINDRO DE RUEDA	0116366	IZQ	17.4 mm 11/16"		373
		87-89	CILINDRO MAESTRO	114190		22.2 mm 7/8"		298
		90-91	CILINDRO MAESTRO	114192		24.0 mm		298
		92-93	CILINDRO MAESTRO	114195		24.0 mm		298
		83-86	CILINDRO MAESTRO	116403		22.2 mm 7/8"		298
		94-96	CILINDRO MAESTRO	390179		24mm		302
		83-96	KIT DE PISTÓN Y REPUESTO FD	742367	DEL	63.5 mm 2-1/2"		
		94-96	REP. CIL. MAESTRO Y DE CLUTCH	1831		24.0 mm		557
		83-86	REP. CIL. MAESTRO Y DE CLUTCH	99984		22.2 mm 7/8"		560
		87-89	REP. CIL. MAESTRO Y DE CLUTCH	114191		22.2 mm 7/8"		561
		90-93	REP. CIL. MAESTRO Y DE CLUTCH	114196		24.0 mm		561
	94-96	REPUESTO CILINDRO DE RUEDA	112342		22.2 mm 7/8"			
ENCLAVE		05-09	CILINDRO MAESTRO	390401		1"	C/ABS	312
		10-13	CILINDRO MAESTRO	391154		1"		345
LACROSSE		05-09	MANGUERA DE FRENOS	380581	DEL IZQ DER	15.5"	CX	426
		08-09	MANGUERA DE FRENOS	380581	DEL IZQ DER	15.5"	CXL	426
		08-09	MANGUERA DE FRENOS	381271	DEL IZQ DER	10.88"	SUPER	439
LE SABRE		00-03	CILINDRO MAESTRO	390552		1"		318
		00-05	MANGUERA DE FRENOS	380406	DEL IZQ DER	12.5"		419
		00-05	MANGUERA DE FRENOS	381382	IZQ	18.75"		445
		00-05	MANGUERA DE FRENOS	381383	DER	18.75"		445
REGAL		94-96	MANGUERA DE FRENOS	38587	DEL DER	18.11"		392
		94-96	MANGUERA DE FRENOS	38588	DEL IZQ	17.88"		392
		95-96	MANGUERA DE FRENOS	380478	TRAS IZQ	12.25"		422
		94-96	PISTÓN FRENO DE DISCO	85159	DEL	42.1 mm 1-21/32"		520
		94-96	REPUESTO FRENO DE DISCO	1759	TRAS	38.1 mm 1-1/2"		
		94-96	REPUESTO FRENO DE DISCO	1930	DEL	42.1 mm 1-21/32"		
		94-96	CILINDRO MAESTRO	390175		24mm		302
	94-96	REP. CIL. MAESTRO Y DE CLUTCH	114196		24.0 mm		561	
VERANO		12-13	CILINDRO MAESTRO	391154		1"		345
CADILLAC								
CATERA		97-01	MANGUERA DE FRENOS	38658	TRAS DER	9.5"		395
		97-01	MANGUERA DE FRENOS	38658	TRAS IZQ	9.5"		395
		97-01	PISTÓN FRENO DE DISCO	85261	DEL	57.1 mm 2-1/4"		522
		97-01	PISTÓN FRENO DE DISCO	85262	TRAS	40.0 mm		522
		97-01	REPUESTO FRENO DE DISCO	2261	DEL	57.1 mm 2-1/4"		541
CTS		03-07	MANGUERA DE FRENOS	382463	DEL IZQ	19.25"		466
		03-07	MANGUERA DE FRENOS	382607	TRAS IZQ	14.5"		476
		03-07	PISTÓN FRENO DE DISCO	851052	N/D	N/D		533
		03-07	REPUESTO FRENO DE DISCO	21025	TRAS	51.0 mm		547





Modelo	Versión	Año	Descripción	Número Lusac	Posición	Diámetro	Notas	Foto Pág.	
CADILLAC									
CTS		03-07	REPUESTO FRENO DE DISCO	21052	DEL Y TRAS	45.5 mm		549	
CTS-V		04-07	MANGUERA DE FRENOS	382463	DER	19.25"		466	
		04-07	MANGUERA DE FRENOS	382607	IZQ	14.5"		476	
		04-06	MANGUERA DE FRENOS	382628	IZQ	18.88"		478	
		04-06	MANGUERA DE FRENOS	382629	DER	19.18"		478	
DEVILLE		91-93	MANGUERA DE FRENOS	38253	DEL IZQ	18.25"		390	
		91-93	MANGUERA DE FRENOS	38262	DEL DER	18.31"		390	
		91-93	MANGUERA DE FRENOS	38951	TRAS DER	12.5"		402	
		91-93	MANGUERA DE FRENOS	38951	TRAS IZQ	12.5"		402	
		94-95	MANGUERA DE FRENOS	380272	TRAS IZQ	12.38"		411	
		00-04	MANGUERA DE FRENOS	380406	TRAS DER	12.5"		419	
		00-04	MANGUERA DE FRENOS	380406	TRAS IZQ	12.5"		419	
		94-95	MANGUERA DE FRENOS	380414	TRAS DER	14"		419	
		96-99	MANGUERA DE FRENOS	380557	TRAS IZQ	12.5"		426	
		94-99	MANGUERA DE FRENOS	380907	DEL IZQ	17 13/16"		428	
		94-99	MANGUERA DE FRENOS	380908	DEL DER	17 13/16"		428	
		00-04	MANGUERA DE FRENOS	381382	DEL IZQ	18.75"		445	
		00-04	MANGUERA DE FRENOS	381383	DEL DER	18.75"		445	
		97-04	PISTÓN FRENO DE DISCO	85088	DEL	63.5 mm 2-1/2"		519	
		94-99	REPUESTO FRENO DE DISCO	1759	TRAS	38.1 mm 1-1/2"			
		91-04	REPUESTO FRENO DE DISCO	99024	DEL	63.5 mm 2-1/2"		553	
	CONCOURS		94-96	CILINDRO DE RUEDA	37855	DER	23.8 mm 15/16"		367
	CONCOURS		94-96	CILINDRO DE RUEDA	37855	IZQ	23.8 mm 15/16"		367
	CONCOURS		94-96	CILINDRO MAESTRO	39566		28.6mm & 40mm	S/ABS	294
	CONCOURS		94-96	CILINDRO MAESTRO	39955		1"	C/ABS	296
	CONCOURS		94-96	MANGUERA DE FRENOS	38253	DEL IZQ	18.25"		390
	CONCOURS		94-96	MANGUERA DE FRENOS	38262	DEL DER	18.31"		390
	CONCOURS		94-96	MANGUERA DE FRENOS	38951	TRAS DER	12.5"		402
	CONCOURS		94-96	MANGUERA DE FRENOS	38951	TRAS IZQ	12.5"		402
	CONCOURS		94-96	REPUESTO FRENO DE DISCO	99024	DEL	63.5 mm 2-1/2"		553
			91-93	CILINDRO DE RUEDA	37855	DER	23.8 mm 15/16"		367
			91-93	CILINDRO DE RUEDA	37855	IZQ	23.8 mm 15/16"		367
			02-02	CILINDRO DE RUEDA	370190	TRAS IZQ DER	15/16"		381
			91-93	CILINDRO MAESTRO	39566		28.6mm & 40mm	S/ABS	294
			91-93	CILINDRO MAESTRO	39955		1"	C/ABS	296
			94-94	CILINDRO MAESTRO	39962		1"	S/C DE TRANSMISIÓN	296
			95-99	CILINDRO MAESTRO	390267		1"		306
			00-04	CILINDRO MAESTRO	390552		1"		318
		90-93	KIT DE PISTÓN Y REPUESTO FD	742351	DEL	74.6 mm 2-15/16"			
		97-99	KIT DE PISTÓN Y REPUESTO FD	742351	DEL	74.6 mm 2-15/16"			
		91-93	MANGUERA DE FRENOS	38746	DEL DER	21.25"	CHOCOLATE	397	
		91-93	MANGUERA DE FRENOS	38747	DEL IZQ	21.25"	CHOCOLATE	397	
		05-05	MANGUERA DE FRENOS	380406	DEL IZQ DER	12.5"	ROTORES DE 5 PERNOS; CÓDIGO DE FRENOS GM JL9	419	

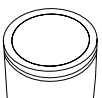

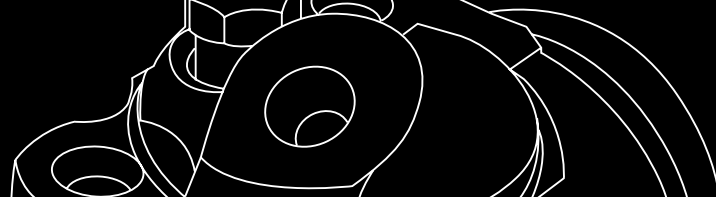

Modelo	Versión	Año	Descripción	Número Lusac	Posición	Diámetro	Notas	Foto Pág.
DEVILLE		05-05	MANGUERA DE FRENOS	381382	IZQ	18.75"	ROTORES DE 5 PERNOS; CÓDIGO DE FRENOS GM JL9	445
		05-05	MANGUERA DE FRENOS	381383	DER	18.75"	ROTORES DE 5 PERNOS; CÓDIGO DE FRENOS GM JL9	445
DTS		06-08	PISTÓN FRENO DE DISCO	851070	DEL	57.1 mm 2-1/4"	CALIPER DOBLE PISTON	533
		06-08	REPUESTO FRENO DE DISCO	2107	DEL	57.1 mm 2-1/4"	CALIPER DOBLE PISTON	539
ELDORADO		94-95	MANGUERA DE FRENOS	380272	TRAS IZQ	12.38"		411
		94-95	MANGUERA DE FRENOS	380414	TRAS DER	14"		419
		96-97	MANGUERA DE FRENOS	380557	TRAS IZQ	12.5"		426
		94-97	MANGUERA DE FRENOS	380907	DEL IZQ	17 13/16"		428
		94-97	MANGUERA DE FRENOS	380908	DEL DER	17 13/16"		428
		94-97	REPUESTO FRENO DE DISCO	1759	TRAS	38.1 mm 1-1/2"		
		94-97	REPUESTO FRENO DE DISCO	99024	DEL	63.5 mm 2-1/2"		553
		95-02	CILINDRO MAESTRO	390267		1"		306
		98-02	MANGUERA DE FRENOS	38081	CTR	7.5"		388
		98-02	MANGUERA DE FRENOS	380557	IZQ	12.5"		426
ESCALADE		02-06	MANGUERA DE FRENOS	382412	DEL IZQ	28.38"		464
		02-06	MANGUERA DE FRENOS	382414	DEL DER	27.38"		464
		02-06	MANGUERA DE FRENOS	382610	TRAS IZQ	11.56"		476
		07-12	MANGUERA DE FRENOS	382615	TRAS IZQ	15.5" & 15"		477
		02-06	PISTÓN FRENO DE DISCO	85119	TRAS	45.0 mm		519
		02-06	PISTÓN FRENO DE DISCO	85157	DEL	74.6 mm 2-15/16"	CALIPER DOBLE PISTON	520
		02-06	REPUESTO FRENO DE DISCO	2005	DEL	74.6 mm 2-15/16"	CALIPER DOBLE PISTON	538
		02-06	REPUESTO FRENO DE DISCO	2119	TRAS	45.0 mm		540
		07-14	REPUESTO FRENO DE DISCO	2159	TRAS	50.8 mm 2"		540
		02-03	REPUESTO FRENO DE DISCO	2475	TRAS	46.0 mm 1-13/16"	CALIPER DOBLE PISTON	541
		07-12	REPUESTO FRENO DE DISCO	21045	DEL	50.8mm 2"		548
	ESV	04-06	CILINDRO MAESTRO	390804		34mm		329
	ESV	04-06	CILINDRO MAESTRO	390806		1-1/4"		329
	ESV	04-06	CILINDRO MAESTRO	390843		34mm		331
	ESV	07-08	CILINDRO MAESTRO	390986		1-1/4"		338
	ESV	09-14	CILINDRO MAESTRO	391172		1-1/4"		346
	ESV	04-06	MANGUERA DE FRENOS	382412	DEL IZQ	28.38"		464
	ESV	04-06	MANGUERA DE FRENOS	382414	DEL DER	27.38"		464
	ESV	04-06	MANGUERA DE FRENOS	382610	TRAS IZQ	11.56"		476
	ESV	07-12	MANGUERA DE FRENOS	382615	TRAS IZQ	15.5" & 15"		477
	ESV	04-06	PISTÓN FRENO DE DISCO	85119	TRAS	45.0 mm		519
	ESV	04-06	PISTÓN FRENO DE DISCO	85157	DEL	74.6 mm 2-15/16"	CALIPER DOBLE PISTON	520
	ESV	04-06	REPUESTO FRENO DE DISCO	2005	DEL	74.6 mm 2-15/16"	CALIPER DOBLE PISTON	538
ESV	04-06	REPUESTO FRENO DE DISCO	2119	TRAS	45.0 mm		540	

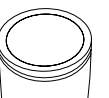



Modelo	Versión	Año	Descripción	Número Lusac	Posición	Diámetro	Notas	Foto Pág.
CADILLAC								
ESCALADE	ESV	07-14	REPUESTO FRENO DE DISCO	2159	TRAS	50.8 mm 2"		540
	ESV	04-06	REPUESTO FRENO DE DISCO	2475	TRAS	46.0 mm 1-13/16"	CALIPER DOBLE PISTON	541
	EXT	04-06	CILINDRO MAESTRO	390804		34mm	4X4	329
	EXT	03-03	CILINDRO MAESTRO	390805		1-1/4"	4X4	329
	EXT	03-06	CILINDRO MAESTRO	390806		1-1/4"		329
	EXT	03-06	CILINDRO MAESTRO	390843		34mm		331
	EXT	07-08	CILINDRO MAESTRO	390986		1-1/4"	4X4	338
	EXT	13-14	CILINDRO MAESTRO	391172		1-1/4"		346
	EXT	09-12	CILINDRO MAESTRO	391172		1-1/4"	4X4	346
	EXT	03-06	MANGUERA DE FRENOS	382412	DEL IZQ	28.38"		464
	EXT	03-06	MANGUERA DE FRENOS	382414	DEL DER	27.38"		464
	EXT	03-06	MANGUERA DE FRENOS	382610	TRAS IZQ	11.56"		476
	EXT	07-12	MANGUERA DE FRENOS	382615	TRAS IZQ	15.5" & 15"		477
	EXT	03-06	PISTÓN FRENO DE DISCO	85119	TRAS	45.0 mm		519
	EXT	03-06	PISTÓN FRENO DE DISCO	85157	DEL	74.6 mm 2-15/16"	CALIPER DOBLE PISTON	520
	EXT	03-06	REPUESTO FRENO DE DISCO	2005	DEL	74.6 mm 2-15/16"	CALIPER DOBLE PISTON	538
	EXT	03-06	REPUESTO FRENO DE DISCO	2119	TRAS	45.0 mm		540
	EXT	07-14	REPUESTO FRENO DE DISCO	2159	TRAS	50.8 mm 2"		540
	EXT	03-06	REPUESTO FRENO DE DISCO	2475	TRAS	46.0 mm 1-13/16"	CALIPER DOBLE PISTON	541
		99-00	CILINDRO DE RUEDA	116359	TRAS IZQ DER	25.4 mm 1"		373
		99-00	CILINDRO MAESTRO	390259		40mm & 1/8"		306
		02-03	CILINDRO MAESTRO	390541		34mm		317
		02-03	CILINDRO MAESTRO	390542		37mm		318
		04-06	CILINDRO MAESTRO	390804		34mm		329
		03-03	CILINDRO MAESTRO	390805		1-1/4"		329
		04-06	CILINDRO MAESTRO	390806		1-1/4"		329
		04-06	CILINDRO MAESTRO	390843		34mm		331
		07-08	CILINDRO MAESTRO	390986		1-1/4"		338
		09-14	CILINDRO MAESTRO	391172		1-1/4"		346
		02-03	CILINDRO MAESTRO	18060790		37.0 mm		360
		02-06	KIT DE PISTÓN Y REPUESTO FD	742351	DEL	74.6 mm 2-15/16"		
		02-06	KIT DE PISTÓN Y REPUESTO FD	742369	TRAS	45.0 mm	2X4 4X4	
		99-00	MANGUERA DE FRENOS	38624	CTR	17.75"		394
	00-00	MANGUERA DE FRENOS	382412	IZQ	28.38"		464	
	00-00	MANGUERA DE FRENOS	382414	DER	27.38"		464	
	02-06	REP. CIL. MAESTRO Y DE CLUTCH	904090		34.0mm		563	
	04-06	REPUESTO FRENO DE DISCO	2475	TRAS	46.0 mm 1-13/16"	CALIPER DOBLE PISTON	541	
SEVILLE		96-97	MANGUERA DE FRENOS	38081	TRAS IZQ	7.5"		388
		94-95	MANGUERA DE FRENOS	380272	TRAS IZQ	12.38"		411
		94-97	MANGUERA DE FRENOS	380414	TRAS DER	14"		419
		94-95	MANGUERA DE FRENOS	380907	DEL IZQ	17 13/16"		428
		94-95	MANGUERA DE FRENOS	380908	DEL DER	17 13/16"		428
		96-97	MANGUERA DE FRENOS	381382	DEL IZQ	18.75"		445
		96-97	MANGUERA DE FRENOS	381383	DEL DER	18.75"		445

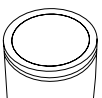



Modelo	Versión	Año	Descripción	Número Lusac	Posición	Diámetro	Notas	Foto Pág.	
SEVILLE		94-97	REPUESTO FRENO DE DISCO	1759	TRAS	38.1 mm 1-1/2"			
		94-97	REPUESTO FRENO DE DISCO	99024	DEL	63.5 mm 2-1/2"		553	
	STS	98-04	CILINDRO MAESTRO	390267		1"		306	
	STS	98-98	MANGUERA DE FRENOS	380268	TRAS DER	12.63"		410	
	STS	99-04	MANGUERA DE FRENOS	380406	TRAS DER	12.5"		419	
	STS	99-04	MANGUERA DE FRENOS	380406	TRAS IZQ	12.5"		419	
	STS	98-01	MANGUERA DE FRENOS	380907	DEL IZQ	17 13/16"		428	
	STS	98-01	MANGUERA DE FRENOS	380908	DEL DER	17 13/16"		428	
	STS	03-04	MANGUERA DE FRENOS	381382	DEL IZQ	18.75"		445	
	STS	03-04	MANGUERA DE FRENOS	381383	DEL DER	18.75"		445	
	STS	98-04	PISTÓN FRENO DE DISCO	85088	DEL	63.5 mm 2-1/2"		519	
	STS	98-01	REPUESTO FRENO DE DISCO	1759	TRAS	38.1 mm 1-1/2"			
	STS	98-04	REPUESTO FRENO DE DISCO	99024	DEL	63.5 mm 2-1/2"		553	
			94-97	CILINDRO MAESTRO	390267		1"		306
			02-02	CILINDRO MAESTRO	390267		1"		306
			02-02	MANGUERA DE FRENOS	380406	DEL IZQ DER	12.5"		419
			02-02	MANGUERA DE FRENOS	381382	IZQ	18.75"		445
			02-02	MANGUERA DE FRENOS	381383	DER	18.75"		445
SRX		04-09	MANGUERA DE FRENOS	382607	TRAS IZQ	14.5"		476	
STS		05-10	MANGUERA DE FRENOS	380342	DEL IZQ	19"		415	
		05-10	MANGUERA DE FRENOS	382607	TRAS IZQ	14.5"		476	
XLR	ROADSTER	04-06	MANGUERA DE FRENOS	382632	DEL DER	18.5"		478	
CHEVROLET									
ALERO		02-04	CILINDRO DE CLUTCH	360111		N.R.	CHOCOLATE		
ASTRA	1.8 LTS	00-03	CILINDRO DE RUEDA	834	DER	19.0 mm 3/4"		364	
	1.8 LTS	00-03	CILINDRO DE RUEDA	834	IZQ	19.0 mm 3/4"		364	
	1.8 LTS	00-03	PISTÓN FRENO DE DISCO	85391	DEL	57.1 mm 2-1/4"		523	
	1.8 LTS	07-08	PISTÓN FRENO DE DISCO	85391	DEL	57.1 mm 2-1/4"		523	
	1.8 LTS	00-03	PISTÓN FRENO DE DISCO	850400	DEL	52.0 mm 2-3/64"		529	
	1.8 LTS	07-08	PISTÓN FRENO DE DISCO	850400	DEL	52.0 mm 2-3/64"		529	
	1.8 LTS	00-00	REPUESTO FRENO DE DISCO	2040	DEL	52.0 mm 2-3/64"		539	
	1.8 LTS	07-08	REPUESTO FRENO DE DISCO	2040	DEL	52.0 mm 2-3/64"		539	
	1.8 LTS	00-00	REPUESTO FRENO DE DISCO	2048	TRAS	34.0 mm		539	
	1.8 LTS	07-08	REPUESTO FRENO DE DISCO	2048	TRAS	34.0 mm		539	
	1.8 LTS	00-03	REPUESTO FRENO DE DISCO	2095	TRAS	34.0 mm			
	1.8 LTS	07-08	REPUESTO FRENO DE DISCO	2095	TRAS	34.0 mm			
	1.8 LTS	00-00	REPUESTO FRENO DE DISCO	2472	DEL	57.1 mm 2-1/4"		541	
	1.8 LTS	07-08	REPUESTO FRENO DE DISCO	2472	DEL	57.1 mm 2-1/4"		541	
	2.0 LTS	04-06	PISTÓN FRENO DE DISCO	85391	DEL	57.1 mm 2-1/4"		523	
	2.0 LTS	04-06	PISTÓN FRENO DE DISCO	850400	DEL	52.0 mm 2-3/64"		529	





Modelo	Versión	Año	Descripción	Número Lusac	Posición	Diámetro	Notas	Foto Pág.
CHEVROLET								
ASTRA	2.0 LTS	04-06	REPUESTO FRENO DE DISCO	2040	DEL	52.0 mm 2-3/64"		539
	2.0 LTS	04-06	REPUESTO FRENO DE DISCO	2048	TRAS	34.0 mm		539
	2.0 LTS	04-06	REPUESTO FRENO DE DISCO	2095	TRAS	34.0 mm		
	2.0 LTS	04-06	REPUESTO FRENO DE DISCO	2472	DEL	57.1 mm 2-1/4"		541
	2.2 LTS	01-03	REPUESTO FRENO DE DISCO	2095	TRAS	34.0 mm		
	1.8 LTS, 2.2 LTS	01-03	CILINDRO MAESTRO	9193225		23.8 mm 15/16"	INC VAGONETA	359
	1.8 LTS, 2.2 LTS	01-03	PISTÓN FRENO DE DISCO	85391	DEL	57.1 mm 2-1/4"	INC VAGONETA	523
	1.8 LTS, 2.2 LTS	01-03	PISTÓN FRENO DE DISCO	850400	DEL	52.0 mm 2-3/64"	INC VAGONETA	529
	1.8 LTS, 2.2 LTS	01-03	REPUESTO FRENO DE DISCO	2040	DEL	52.0 mm 2-3/64"	INC VAGONETA	539
	1.8 LTS, 2.2 LTS	01-03	REPUESTO FRENO DE DISCO	2048	TRAS	34.0 mm	INC VAGONETA	539
	1.8 LTS, 2.2 LTS	01-03	REPUESTO FRENO DE DISCO	2472	DEL	57.1 mm 2-1/4"	INC VAGONETA	541
	TURBO	07-08	CILINDRO MAESTRO	39009903		23.8 mm 15/16"		360
	TURBO	07-08	PISTÓN FRENO DE DISCO	850400	DEL	52.0 mm 2-3/64"		529
	TURBO	07-08	REPUESTO FRENO DE DISCO	2040	DEL	52.0 mm 2-3/64"		539
	VAGONETA	01-03	CILINDRO MAESTRO	39009903		23.8 mm 15/16"	C/ABS	360
		08-09	CILINDRO MAESTRO	391171		1"		346
	1.8 LTS	00-03	CILINDRO MAESTRO	9193225		23.8 mm 15/16"	S/ABS	359
	2.2 LTS	01-03	CILINDRO MAESTRO	9193225		23.8 mm 15/16"	S/ABS	359
	1.8 LTS	00-03	CILINDRO MAESTRO	39009903		23.8 mm 15/16"		360
	1.8 LTS	07-08	CILINDRO MAESTRO	39009903		23.8 mm 15/16"		360
	2.0 LTS	00-06	CILINDRO MAESTRO	39009903		23.8 mm 15/16"	C/ABS	360
	2.2 LTS	01-03	CILINDRO MAESTRO	39009903		23.8 mm 15/16"	C/ABS	360
	1.8 LTS	01-03	PISTÓN FRENO DE DISCO	85391	DEL	57.1 mm 2-1/4"		523
	2.2 LTS	01-03	PISTÓN FRENO DE DISCO	85391	DEL	57.1 mm 2-1/4"		523
	1.8 LTS	01-03	PISTÓN FRENO DE DISCO	850400	DEL	52.0 mm 2-3/64"		529
	2.2 LTS	01-03	PISTÓN FRENO DE DISCO	850400	DEL	52.0 mm 2-3/64"		529
	1.8 LTS	01-03	REPUESTO FRENO DE DISCO	2040	DEL	52.0 mm 2-3/64"		539
	2.2 LTS	01-03	REPUESTO FRENO DE DISCO	2040	DEL	52.0 mm 2-3/64"		539
	1.8 LTS	00-03	REPUESTO FRENO DE DISCO	2048	TRAS	34.0 mm		539
	2.2 LTS	01-03	REPUESTO FRENO DE DISCO	2048	TRAS	34.0 mm		539
1.8 LTS	01-03	REPUESTO FRENO DE DISCO	2472	DEL	57.1 mm 2-1/4"		541	
2.2 LTS	01-03	REPUESTO FRENO DE DISCO	2472	DEL	57.1 mm 2-1/4"		541	
ASTRO		90-02	CILINDRO DE RUEDA	37854	TRAS IZQ DER	7/8"		367
		90-94	CILINDRO MAESTRO	390063		28.6 y 40.0 mm		300
		96-03	CILINDRO MAESTRO	390321		1-1/4"	SALIDA PRIMARIA 9/16", SALIDA SECUNDARIA 1/2"	308

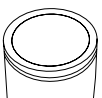



Modelo	Versión	Año	Descripción	Número Lusac	Posición	Diámetro	Notas	Foto Pág.
ASTRO		85-02	MANGUERA DE FRENOS	38261	CTR	14.88"		
		90-99	MANGUERA DE FRENOS	38851	DEL IZQ	19.63"		399
		90-99	MANGUERA DE FRENOS	38852	DEL DER	19.63"		399
AVALANCHE	1500	02-02	CILINDRO MAESTRO	390541		34mm		317
	1500	02-02	CILINDRO MAESTRO	390542		37mm	4X2, 4X4	318
	1500	03-03	CILINDRO MAESTRO	390804		34mm	4X2, 4X4	329
	1500	03-08	CILINDRO MAESTRO	390806		1-1/4"	4X4; V8, 5.3 LTS	329
	1500	04-06	CILINDRO MAESTRO	390843		34mm		331
	1500	07-08	CILINDRO MAESTRO	390986		1-1/4"		338
	1500	09-13	CILINDRO MAESTRO	391172		1-1/4"	4X4; V8, 5.3 LTS	346
	1500	02-02	CILINDRO MAESTRO	18060790		37.0 mm		360
	1500	02-06	MANGUERA DE FRENOS	382412	IZQ	28.38"		464
	1500	02-06	MANGUERA DE FRENOS	382414	DER	27.38"		464
	1500	02-06	MANGUERA DE FRENOS	382610	IZQ	11.56"		476
	1500	03-06	MANGUERA DE FRENOS	382691	CTR	15.5"	C/C FRENOS ACTIVO	482
	2500	02-02	CILINDRO MAESTRO	390542		37mm	4X2, 4X4	318
	2500	03-06	CILINDRO MAESTRO	390818		37mm	4X4; V8, 5.3 LTS	330
	2500	02-02	CILINDRO MAESTRO	18060790		37.0 mm		360
	2500	02-02	MANGUERA DE FRENOS	381381	CTR	16.2"		445
	2500	02-06	MANGUERA DE FRENOS	382417	IZQ	31.25"		464
	2500	02-06	MANGUERA DE FRENOS	382419	DER	31.25"		465
		02-06	KIT DE PISTÓN Y REPUESTO FD	742351	DEL	74.6 mm 2-15/16"		
		02-03	KIT DE PISTÓN Y REPUESTO FD	742369	TRAS	45.0 mm	4X2	
		02-06	KIT DE PISTÓN Y REPUESTO FD	742369	TRAS	45.0 mm	4X4	
		02-06	MANGUERA DE FRENOS	382412	DEL IZQ	28.38"		464
		02-06	MANGUERA DE FRENOS	382414	DEL DER	27.38"		464
		02-06	MANGUERA DE FRENOS	382610	TRAS IZQ	11.56"		476
		07-13	MANGUERA DE FRENOS	382615	TRAS IZQ	15.5" & 15"		477
		02-06	PISTÓN FRENO DE DISCO	85119	TRAS	45.0 mm		519
		02-06	PISTÓN FRENO DE DISCO	85157	DEL	74.6 mm 2-15/16"	CALIPER DOBLE PISTON	520
		02-06	REPUESTO FRENO DE DISCO	2005	DEL	74.6 mm 2-15/16"	CALIPER DOBLE PISTON	538
		02-06	REPUESTO FRENO DE DISCO	2119	TRAS	45.0 mm		540
		02-06	REPUESTO FRENO DE DISCO	2475	TRAS	46.0 mm 1-13/16"	CALIPER DOBLE PISTON	541
		02-06	MANGUERA DE FRENOS	381276	TRAS DER	16"		439
		02-06	MANGUERA DE FRENOS	382417	DEL IZQ	31.25"		464
		02-06	MANGUERA DE FRENOS	382419	DEL DER	31.25"		465
		02-06	PISTÓN FRENO DE DISCO	85119	TRAS	45.0 mm		519
		02-06	PISTÓN FRENO DE DISCO	85157	DEL	74.6 mm 2-15/16"	CALIPER DOBLE PISTON	520
		02-06	REPUESTO FRENO DE DISCO	2005	DEL	74.6 mm 2-15/16"	CALIPER DOBLE PISTON	538
	02-06	REPUESTO FRENO DE DISCO	2119	TRAS	45.0 mm		540	
	02-06	REPUESTO FRENO DE DISCO	2475	TRAS	46.0 mm 1-13/16"	CALIPER DOBLE PISTON	541	
AVEO		08-14	MANGUERA DE FRENOS	381621	TRAS IZQ	9"		451
		08-14	MANGUERA DE FRENOS	382507	DEL DER	14 1/16"		468
		08-14	MANGUERA DE FRENOS	382507	DEL IZQ	14 1/16"		468





Modelo	Versión	Año	Descripción	Número Lusac	Posición	Diámetro	Notas	Foto Pág.
CHEVROLET								
AVEO		08-14	PISTÓN FRENO DE DISCO	85209	DEL	54.0 mm 2-1/8"		521
		08-14	CILINDRO DE RUEDA	370103	DER	13/16"		376
		08-14	CILINDRO DE RUEDA	370103	IZQ	13/16"		376
		08-08	CILINDRO MAESTRO	390881		22.2 mm 7/8"	C/ABS TRANSMISIÓN ESTÁNDAR	333
		08-08	CILINDRO MAESTRO	390888		22.2 mm 7/8"	C/ABS, TRANSMISIÓN AUTOMÁTICA	333
		08-08	CILINDRO MAESTRO	391146		22.2 mm 7/8"	S/ABS	344
		09-11	CILINDRO MAESTRO	391331		22.2 mm 7/8"	C/ABS, TRANSMISIÓN AUTOMÁTICA	355
		09-11	CILINDRO MAESTRO	391332		22.2 mm 7/8"	C/ABS TRANSMISIÓN ESTÁNDAR	355
	09-11	CILINDRO MAESTRO	391333		22.2 mm 7/8"	S/ABS TRANSMISIÓN ESTÁNDAR	356	
BLAZER		95-97	MANGUERA DE FRENOS	38869	DEL IZQ	21.88"		400
		95-97	MANGUERA DE FRENOS	38870	DEL DER	21.88"		400
		95-01	MANGUERA DE FRENOS	38871	DEL DER	18.88"		400
		95-01	MANGUERA DE FRENOS	38871	DEL IZQ	18.88"		400
		95-01	MANGUERA DE FRENOS	38871	TRAS CTR	18.88"		400
		95-01	MANGUERA DE FRENOS	38871	TRAS DER	18.88"		400
		95-01	MANGUERA DE FRENOS	38871	TRAS IZQ	18.88"		400
		95-97	MANGUERA DE FRENOS	380280	DEL DER	12.13"		411
		95-97	MANGUERA DE FRENOS	380280	DEL IZQ	12.13"		411
		98-01	MANGUERA DE FRENOS	380469	TRAS DER	10"		421
		00-01	MANGUERA DE FRENOS	380469	TRAS IZQ	10"		421
		00-01	MANGUERA DE FRENOS	380520	TRAS DER	19.25"		424
		96-97	MANGUERA DE FRENOS	380520	TRAS DER	19.25"		424
		00-01	MANGUERA DE FRENOS	380520	TRAS IZQ	19.25"		424
		96-97	MANGUERA DE FRENOS	380520	TRAS IZQ	19.25"		424
		98-99	MANGUERA DE FRENOS	381032	DEL IZQ	19.12"		431
		98-99	MANGUERA DE FRENOS	381033	DEL DER	19.12"		431
		98-99	MANGUERA DE FRENOS	381064	TRAS IZQ	12.73"		432
		98-99	MANGUERA DE FRENOS	381102	DEL DER	12.19"		433
		98-99	MANGUERA DE FRENOS	381102	DEL IZQ	12.19"		433
		00-01	MANGUERA DE FRENOS	381342	DEL DER	12.45"		442
		00-01	MANGUERA DE FRENOS	381342	DEL IZQ	12.45"		442
		00-01	MANGUERA DE FRENOS	381343	DEL DER	19.45"		443
		00-01	MANGUERA DE FRENOS	381344	DEL IZQ	19.12"		443
		07-10	MANGUERA DE FRENOS	382603	DEL DER	20.88"		476
		07-10	MANGUERA DE FRENOS	382632	TRAS IZQ	18.5"		478
		95-97	PISTÓN FRENO DE DISCO	76033	DEL	63.5 mm 2-1/2"		518
		98-01	PISTÓN FRENO DE DISCO	85475	DEL	46.0 mm 1-13/16"	CALIPER DOBLE PISTON	525
		07-08	PISTÓN FRENO DE DISCO	851052	N/D	N/D		533
		98-01	REPUESTO FRENO DE DISCO	2475	DEL	46.0 mm 1-13/16"	CALIPER DOBLE PISTON	541
	98-01	REPUESTO FRENO DE DISCO	21020	TRAS	48.0 mm 1-57/64"		547	
	95-97	REPUESTO FRENO DE DISCO	99024	DEL	63.5 mm 2-1/2"		553	
NEVADA		91-91	CILINDRO DE RUEDA	51081	DER	23.8 mm 15/16"		370
NEVADA		91-91	CILINDRO DE RUEDA	51081	IZQ	23.8 mm 15/16"		370
NEVADA		92-94	CILINDRO DE RUEDA	116224	DER	30.1 mm 1-3/16"		373
NEVADA		92-94	CILINDRO DE RUEDA	116224	IZQ	30.1 mm 1-3/16"		373
NEVADA		91-91	CILINDRO MAESTRO	39308		30mm		294





Modelo	Versión	Año	Descripción	Número Lusac	Posición	Diámetro	Notas	Foto Pág.	
BLAZER	NEVADA	92-94	CILINDRO MAESTRO	39646		28.6mm & 40mm		294	
	NEVADA	91-91	CILINDRO MAESTRO	104516		28.5 & 40.0 mm	4X2	297	
	NEVADA	91-91	CILINDRO MAESTRO	104516		28.5 & 40.0 mm	4X4	297	
	NEVADA	91-91	MANGUERA DE FRENOS	1197	TRAS DER	14 11/16"		385	
	NEVADA	91-91	MANGUERA DE FRENOS	1197	TRAS IZQ	14 11/16"		385	
	NEVADA	91-91	MANGUERA DE FRENOS	38059	DEL IZQ	20.75"		388	
	NEVADA	91-91	MANGUERA DE FRENOS	38061	DEL DER	19.5"		388	
	NEVADA	92-94	MANGUERA DE FRENOS	38624	TRAS DER	17.75"		394	
	NEVADA	92-94	MANGUERA DE FRENOS	38624	TRAS IZQ	17.75"		394	
	NEVADA	92-94	MANGUERA DE FRENOS	38664	DEL IZQ	19.5"		395	
	NEVADA	92-94	MANGUERA DE FRENOS	38665	DEL DER	19.5"		395	
	NEVADA	91-91	PISTÓN FRENO DE DISCO	76008	DEL	74.6 mm 2-15/16"		518	
	NEVADA	92-94	PISTÓN FRENO DE DISCO	85157	DEL	74.6 mm 2-15/16"		520	
	NEVADA	92-94	REP. CIL. MAESTRO Y DE CLUTCH	1737		28.5 mm 1-1/8"		557	
	NEVADA	91-91	REP. CIL. MAESTRO Y DE CLUTCH	104459		28.5 mm 1-1/8"		560	
	NEVADA	92-94	REPUESTO FRENO DE DISCO	2005	DEL	74.6 mm 2-15/16"		538	
	NEVADA	91-91	REPUESTO FRENO DE DISCO	59176	DEL	74.6 mm 2-15/16"		552	
			83-91	CILINDRO DE CLUTCH	37728		20.5 mm		
			90-91	CILINDRO DE CLUTCH	37816		20.6 mm 13/16"		
			84-90	CILINDRO DE CLUTCH	39732		17.8 mm 45/64"		
			92-95	CILINDRO DE CLUTCH	350042	SUP	17.7 mm		
			03-05	CILINDRO DE CLUTCH	360128		N.R.	NACIONAL	
			95-97	CILINDRO DE RUEDA	37854	DER	7/8"		367
			95-97	CILINDRO DE RUEDA	37854	IZQ	7/8"		367
			98-01	CILINDRO DE RUEDA	37967	DER	13/16"		369
			98-01	CILINDRO DE RUEDA	37967	IZQ	13/16"		369
			07-10	CILINDRO DE RUEDA	370148	DER	15/16"		378
			07-10	CILINDRO DE RUEDA	370148	IZQ	15/16"		378
			95-95	CILINDRO MAESTRO	39571		24mm & 36mm	4X2 4X4	294
			96-97	CILINDRO MAESTRO	390320		36mm & 24mm	4X2 4X4	308
			98-01	CILINDRO MAESTRO	390427		1"	4X2 4X4	313
			00-05	CILINDRO MAESTRO	390571		1"	GRAB. DX	319
			07-08	CILINDRO MAESTRO	390845		1"	4X4	331
			98-99	CILINDRO MAESTRO	18026274		25.4 mm 1"		360
			92-94	KIT DE PISTÓN Y REPUESTO FD	742351	DEL	74.6 mm 2-15/16"		
			95-97	KIT DE PISTÓN Y REPUESTO FD	742367	DEL	63.5 mm 2-1/2"		
			02-05	MANGUERA DE FRENOS	38871	CTR	18.88"	SPORT UTILITY VEHICLE (4 PTAS)	400
			02-05	MANGUERA DE FRENOS	380469	EXT	10"	4X2 S/ZR2 HIGH WIDER PACKAGE	421
			02-05	MANGUERA DE FRENOS	380520	CTR	19.25"	SPORT UTILITY VEHICLE (2 PTAS)	424
			02-05	MANGUERA DE FRENOS	381064	EXT	12.73"	ZR2 HIGH WIDER PACKAGE	432
		02-05	MANGUERA DE FRENOS	381065	EXT	11.93"	4X4 S/ZR2 HIGH WIDER PACKAGE	433	
		02-05	MANGUERA DE FRENOS	381342	DEL IZQ DER	12.45"	LS 4X2	442	
		02-05	MANGUERA DE FRENOS	382509	IZQ	11 1/16"	4X2 LOW RIDER PACKAGE	468	
		02-05	MANGUERA DE FRENOS	382510	DER	11 1/16"	4X2 LOW RIDER PACKAGE	468	

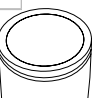



Modelo	Versión	Año	Descripción	Número Lusac	Posición	Diámetro	Notas	Foto Pág.
CHEVROLET								
BLAZER		95-95	REP. CIL. MAESTRO Y DE CLUTCH	107051		24.0 mm		560
C-15		82-87	MANGUERA DE FRENOS	1198	TRAS DER	14 11/16"		
		82-87	MANGUERA DE FRENOS	1198	TRAS IZQ	14 11/16"		
		82-87	MANGUERA DE FRENOS	4042	DEL DER	22 3/4"		
		82-87	MANGUERA DE FRENOS	4043	DEL IZQ	22 3/4"		
		88-91	MANGUERA DE FRENOS	38620	DEL IZQ	25.13"		394
		94-99	MANGUERA DE FRENOS	38620	DEL IZQ	25.13"		394
		88-91	MANGUERA DE FRENOS	38621	DEL DER	25.13"		394
		94-99	MANGUERA DE FRENOS	38621	DEL DER	25.13"		394
		88-91	MANGUERA DE FRENOS	38624	TRAS DER	17.75"		394
		88-91	MANGUERA DE FRENOS	38624	TRAS IZQ	17.75"		394
		94-99	MANGUERA DE FRENOS	38624	TRAS IZQ	17.75"		394
		82-87	PISTÓN FRENO DE DISCO	76008	DEL	74.6 mm 2-15/16"		518
		94-99	PISTÓN FRENO DE DISCO	85157	DEL	74.6 mm 2-15/16"		520
		88-91	PISTÓN FRENO DE DISCO	85158	DEL	63.5 mm 2-1/2"		520
		88-91	REPUESTO FRENO DE DISCO	1973	DEL	63.5 mm 2-1/2"		538
		94-99	REPUESTO FRENO DE DISCO	2005	DEL	74.6 mm 2-15/16"		538
		82-87	REPUESTO FRENO DE DISCO	59176	DEL	74.6 mm 2-15/16"		552
		82-87	CILINDRO DE RUEDA	51081	IZQ	23.8 mm 15/16"		370
		82-87	CILINDRO DE RUEDA	51088	DER	25.4 mm 1"		370
		94-99	CILINDRO DE RUEDA	116224	DER	30.1 mm 1-3/16"		373
		94-99	CILINDRO DE RUEDA	116224	IZQ	30.1 mm 1-3/16"		373
		88-91	CILINDRO DE RUEDA	116263	DER	28.5 mm 1-1/8"		373
		94-94	CILINDRO DE RUEDA	116263	DER	28.5 mm 1-1/8"		373
		96-99	CILINDRO DE RUEDA	116263	DER	28.5 mm 1-1/8"		373
		88-91	CILINDRO DE RUEDA	116263	IZQ	28.5 mm 1-1/8"		373
		94-94	CILINDRO DE RUEDA	116263	IZQ	28.5 mm 1-1/8"		373
		96-99	CILINDRO DE RUEDA	116263	IZQ	28.5 mm 1-1/8"		373
		95-95	CILINDRO DE RUEDA	116359	DER	25.4 mm 1"		373
		95-95	CILINDRO DE RUEDA	116359	IZQ	25.4 mm 1"		373
		94-94	CILINDRO MAESTRO	39646		28.6mm & 40mm		294
		88-91	CILINDRO MAESTRO	104466		25.4 & 36.0mm		297
		82-87	CILINDRO MAESTRO	104516		28.5 & 40.0 mm		297
		95-99	CILINDRO MAESTRO	390257		1-1/4"	HYDROBOOSTER	306
	94-99	CILINDRO MAESTRO	390259		40mm & 1/8"	FABRICACION NACIONAL	306	
	96-99	MANGUERA DE FRENOS	38620	DEL IZQ	25.13"		394	
	96-99	MANGUERA DE FRENOS	38621	DEL DER	25.13"		394	
	96-99	MANGUERA DE FRENOS	38624	TRAS IZQ	17.75"		394	
	96-99	PISTÓN FRENO DE DISCO	85157	DEL	74.6 mm 2-15/16"		520	
	94-94	REP. CIL. MAESTRO Y DE CLUTCH	1737		28.5 mm 1-1/8"		557	
	95-99	REP. CIL. MAESTRO Y DE CLUTCH	39650		31.7 mm 1-1/4"		557	
	82-87	REP. CIL. MAESTRO Y DE CLUTCH	104459		28.5 mm 1-1/8"		560	
	94-99	REP. CIL. MAESTRO Y DE CLUTCH	104459		28.5 mm 1-1/8"		560	
	88-91	REP. CIL. MAESTRO Y DE CLUTCH	104467		25.4 mm 1"		560	

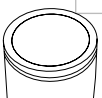

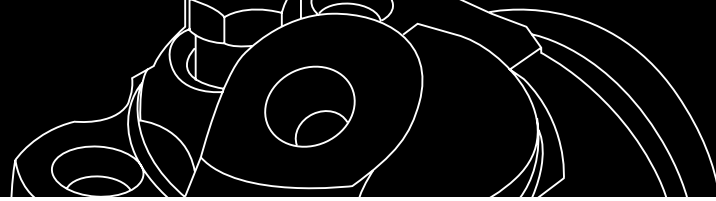

Modelo	Versión	Año	Descripción	Número Lusac	Posición	Diámetro	Notas	Foto Pág.
C-15		96-99	REPUESTO FRENO DE DISCO	2005	DEL	74.6 mm 2-15/16"		538
C-1500		88-91	CILINDRO DE CLUTCH	37815		20.6 mm 13/16"		
		92-95	CILINDRO DE CLUTCH	350042	SUP	17.7 mm		
		94-95	CILINDRO DE CLUTCH	350182		18.0 mm		
		94-99	KIT DE PISTÓN Y REPUESTO FD	742351	DEL	74.6 mm 2-15/16"		
		96-99	MANGUERA DE FRENOS	38620	DEL IZQ	25.13"		394
		96-99	MANGUERA DE FRENOS	38621	DEL DER	25.13"		394
		96-99	MANGUERA DE FRENOS	38624	TRAS IZQ	17.75"		394
		96-99	PISTÓN FRENO DE DISCO	85157	DEL	74.6 mm 2-15/16"		520
		96-99	REPUESTO FRENO DE DISCO	2005	DEL	74.6 mm 2-15/16"		538
		96-99	CILINDRO DE RUEDA	116224	DER	30.1 mm 1-3/16"		373
		96-99	CILINDRO DE RUEDA	116224	IZQ	30.1 mm 1-3/16"		373
		96-99	CILINDRO DE RUEDA	116263	DER	28.5 mm 1-1/8"		373
		96-99	CILINDRO DE RUEDA	116263	IZQ	28.5 mm 1-1/8"		373
	C-1500		96-99	CILINDRO MAESTRO	390257		1-1/4"	HYDROBOOSTER
		96-99	CILINDRO MAESTRO	390259		40mm & 1/8"	FABRICACION NACIONAL	306
		96-99	MANGUERA DE FRENOS	38620	DEL IZQ	25.13"		394
		96-99	MANGUERA DE FRENOS	38621	DEL DER	25.13"		394
		96-99	MANGUERA DE FRENOS	38624	TRAS IZQ	17.75"		394
		96-99	PISTÓN FRENO DE DISCO	85157	DEL	74.6 mm 2-15/16"		520
		96-99	REP. CIL. MAESTRO Y DE CLUTCH	39650		31.7 mm 1-1/4"		557
		96-99	REP. CIL. MAESTRO Y DE CLUTCH	104459		28.5 mm 1-1/8"		560
C-20		96-99	REPUESTO FRENO DE DISCO	2005	DEL	74.6 mm 2-15/16"		538
		88-91	CILINDRO DE CLUTCH	37815		20.6 mm 13/16"		
		92-00	MANGUERA DE FRENOS	38620	DEL IZQ	25.13"		394
		92-00	MANGUERA DE FRENOS	38621	DEL DER	25.13"		394
		92-00	MANGUERA DE FRENOS	38624	TRAS DER	17.75"		394
		92-00	MANGUERA DE FRENOS	38624	TRAS IZQ	17.75"		394
		92-00	PISTÓN FRENO DE DISCO	85157	DEL	74.6 mm 2-15/16"		520
		92-00	REPUESTO FRENO DE DISCO	2005	DEL	74.6 mm 2-15/16"		538
		79-87	CILINDRO DE RUEDA	51088	DER	25.4 mm 1"	ESTE VEHICULO PUEDE LLEVAR EL CILINDRO DE RUEDA 37080	370
		79-87	CILINDRO DE RUEDA	51088	IZQ	25.4 mm 1"	ESTE VEHICULO PUEDE LLEVAR EL CILINDRO DE RUEDA 37080	370
		95-00	CILINDRO DE RUEDA	116224	DER	30.1 mm 1-3/16"		373
		95-00	CILINDRO DE RUEDA	116224	IZQ	30.1 mm 1-3/16"		373
		88-91	CILINDRO DE RUEDA	116263	DER	28.5 mm 1-1/8"		373
		96-00	CILINDRO DE RUEDA	116263	DER	28.5 mm 1-1/8"		373
		88-91	CILINDRO DE RUEDA	116263	IZQ	28.5 mm 1-1/8"		373
		96-00	CILINDRO DE RUEDA	116263	IZQ	28.5 mm 1-1/8"		373
		92-95	CILINDRO DE RUEDA	116359	DER	25.4 mm 1"		373
		92-95	CILINDRO DE RUEDA	116359	IZQ	25.4 mm 1"		373
		88-94	CILINDRO MAESTRO	39646		28.6mm & 40mm		294





Modelo	Versión	Año	Descripción	Número Lusac	Posición	Diámetro	Notas	Foto Pág.
CHEVROLET								
C-25		79-87	CILINDRO MAESTRO	104516		28.5 & 40.0 mm		297
		95-00	CILINDRO MAESTRO	390257		1-1/4"	HYDROBOOSTER	306
		95-00	CILINDRO MAESTRO	390259		40mm & 1/8"	FABRICACION NACIONAL	306
		79-87	MANGUERA DE FRENOS	1197	TRAS DER	14 11/16"		385
		79-87	MANGUERA DE FRENOS	1197	TRAS IZQ	14 11/16"		385
		79-87	MANGUERA DE FRENOS	36855	DEL DER	22.63"		
		79-87	MANGUERA DE FRENOS	38186	DEL IZQ	21.25"		
		88-00	MANGUERA DE FRENOS	38620	DEL IZQ	25.13"		394
		88-00	MANGUERA DE FRENOS	38621	DEL DER	25.13"		394
		92-00	MANGUERA DE FRENOS	38624	TRAS DER	17.75"		394
		88-00	MANGUERA DE FRENOS	38624	TRAS IZQ	17.75"		394
		79-87	PISTÓN FRENO DE DISCO	76008	DEL	74.6 mm 2-15/16"		518
		92-00	PISTÓN FRENO DE DISCO	85157	DEL	74.6 mm 2-15/16"		520
		88-91	PISTÓN FRENO DE DISCO	85158	DEL	63.5 mm 2-1/2"		520
		88-94	REP. CIL. MAESTRO Y DE CLUTCH	1737		28.5 mm 1-1/8"		557
		95-00	REP. CIL. MAESTRO Y DE CLUTCH	39650		31.7 mm 1-1/4"		557
		79-87	REP. CIL. MAESTRO Y DE CLUTCH	104459		28.5 mm 1-1/8"		560
		95-00	REP. CIL. MAESTRO Y DE CLUTCH	104459		28.5 mm 1-1/8"		560
		88-91	REPUESTO FRENO DE DISCO	1973	DEL	63.5 mm 2-1/2"		538
		92-00	REPUESTO FRENO DE DISCO	2005	DEL	74.6 mm 2-15/16"		538
		79-87	REPUESTO FRENO DE DISCO	59176	DEL	74.6 mm 2-15/16"		552
		88-91	CILINDRO DE CLUTCH	37815		20.6 mm 13/16"		
		92-00	MANGUERA DE FRENOS	38620	DEL IZQ	25.13"		394
		92-00	MANGUERA DE FRENOS	38621	DEL DER	25.13"		394
		92-00	MANGUERA DE FRENOS	38624	TRAS DER	17.75"		394
		92-00	MANGUERA DE FRENOS	38624	TRAS IZQ	17.75"		394
		92-00	PISTÓN FRENO DE DISCO	85157	DEL	74.6 mm 2-15/16"		520
		92-00	REPUESTO FRENO DE DISCO	2005	DEL	74.6 mm 2-15/16"		538
		79-87	CILINDRO DE RUEDA	51088	DER	25.4 mm 1"	ESTE VEHICULO PUEDE LLEVAR EL CILINDRO DE RUEDA 37080	370
		79-87	CILINDRO DE RUEDA	51088	IZQ	25.4 mm 1"	ESTE VEHICULO PUEDE LLEVAR EL CILINDRO DE RUEDA 37080	370
		95-00	CILINDRO DE RUEDA	116224	DER	30.1 mm 1-3/16"		373
		95-00	CILINDRO DE RUEDA	116224	IZQ	30.1 mm 1-3/16"		373
		88-91	CILINDRO DE RUEDA	116263	DER	28.5 mm 1-1/8"		373
		96-00	CILINDRO DE RUEDA	116263	DER	28.5 mm 1-1/8"		373
		88-91	CILINDRO DE RUEDA	116263	IZQ	28.5 mm 1-1/8"		373
		96-00	CILINDRO DE RUEDA	116263	IZQ	28.5 mm 1-1/8"		373
	92-95	CILINDRO DE RUEDA	116359	DER	25.4 mm 1"		373	
	92-95	CILINDRO DE RUEDA	116359	IZQ	25.4 mm 1"		373	
	88-94	CILINDRO MAESTRO	39646		28.6mm & 40mm		294	

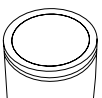

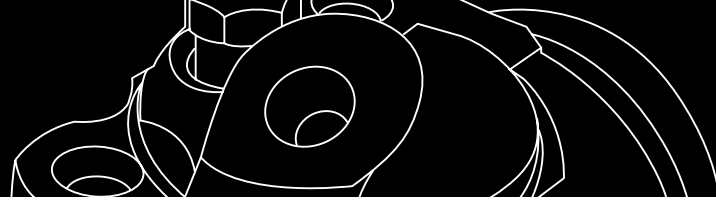

Modelo	Versión	Año	Descripción	Número Lusac	Posición	Diámetro	Notas	Foto Pág.
C-25		79-87	CILINDRO MAESTRO	104516		28.5 & 40.0 mm		297
		95-00	CILINDRO MAESTRO	390257		1-1/4"	HYDROBOOSTER	306
		95-00	CILINDRO MAESTRO	390259		40mm & 1/8"	FABRICACION NACIONAL	306
		79-87	MANGUERA DE FRENOS	1197	TRAS DER	14 11/16"		385
		79-87	MANGUERA DE FRENOS	1197	TRAS IZQ	14 11/16"		385
		79-87	MANGUERA DE FRENOS	36855	DEL DER	22.63"		
		79-87	MANGUERA DE FRENOS	38186	DEL IZQ	21.25"		
		88-00	MANGUERA DE FRENOS	38620	DEL IZQ	25.13"		394
		88-00	MANGUERA DE FRENOS	38621	DEL DER	25.13"		394
		92-00	MANGUERA DE FRENOS	38624	TRAS DER	17.75"		394
		88-00	MANGUERA DE FRENOS	38624	TRAS IZQ	17.75"		394
		79-87	PISTÓN FRENO DE DISCO	76008	DEL	74.6 mm 2-15/16"		518
		92-00	PISTÓN FRENO DE DISCO	85157	DEL	74.6 mm 2-15/16"		520
		88-91	PISTÓN FRENO DE DISCO	85158	DEL	63.5 mm 2-1/2"		520
		88-94	REP. CIL. MAESTRO Y DE CLUTCH	1737		28.5 mm 1-1/8"		557
		95-00	REP. CIL. MAESTRO Y DE CLUTCH	39650		31.7 mm 1-1/4"		557
		79-87	REP. CIL. MAESTRO Y DE CLUTCH	104459		28.5 mm 1-1/8"		560
		95-00	REP. CIL. MAESTRO Y DE CLUTCH	104459		28.5 mm 1-1/8"		560
		88-91	REPUESTO FRENO DE DISCO	1973	DEL	63.5 mm 2-1/2"		538
		92-00	REPUESTO FRENO DE DISCO	2005	DEL	74.6 mm 2-15/16"		538
	79-87	REPUESTO FRENO DE DISCO	59176	DEL	74.6 mm 2-15/16"		552	
C-2500		92-95	CILINDRO DE CLUTCH	350042	SUP	17.7 mm		
		94-95	CILINDRO DE CLUTCH	350182		18.0 mm		
		92-95	CILINDRO DE CLUTCH	360027	INF	20.0 mm		
		00-00	KIT DE PISTÓN Y REPUESTO FD	742344	DEL	50.8 mm 2"	4X2 4X4	
		92-00	KIT DE PISTÓN Y REPUESTO FD	742351	DEL	74.6 mm 2-15/16"		
	SILVERDAO CLASSIC	99-00	CILINDRO DE RUEDA	79767	TRAS IZQ DER	26.9 mm 1-1/16"		371
	SILVERDAO CLASSIC	99-00	CILINDRO MAESTRO	390257		1-1/4"		306
	SILVERDAO CLASSIC	99-00	CILINDRO MAESTRO	390259		40mm & 1/8"		306
	SILVERDAO CLASSIC	99-00	MANGUERA DE FRENOS	38624	CTR	17.75"		394
	SILVERDAO CLASSIC	99-00	MANGUERA DE FRENOS	380248	IZQ	20.63"		410
SILVERDAO CLASSIC	99-00	MANGUERA DE FRENOS	380249	DER	20.63"		410	
C-30		88-91	CILINDRO DE CLUTCH	37815		20.6 mm 13/16"		
		84-87	CILINDRO DE RUEDA	79767	DER	26.9 mm 1-1/16"		371
		84-87	CILINDRO DE RUEDA	79767	IZQ	26.9 mm 1-1/16"		371
		84-87	CILINDRO DE RUEDA	079768	DER	30.1 mm 1-3/16"		371
		84-87	CILINDRO DE RUEDA	079768	IZQ	30.1 mm 1-3/16"		371
		84-87	CILINDRO MAESTRO	98953		33.3 mm 1-5/16"		297
		84-87	CILINDRO MAESTRO	108145		33.3 mm 1-5/16"		
		84-87	MANGUERA DE FRENOS	1198	TRAS DER	14 11/16"		
		84-87	MANGUERA DE FRENOS	1198	TRAS IZQ	14 11/16"		





Modelo	Versión	Año	Descripción	Número Lusac	Posición	Diámetro	Notas	Foto Pág.
CHEVROLET								
C-30		84-87	MANGUERA DE FRENOS	36952	DEL IZQ	23.13"		
		84-87	MANGUERA DE FRENOS	36957	DEL DER	23.16"		387
		84-87	PISTÓN FRENO DE DISCO	76028	DEL	85.7 mm 3-3/8"		518
		84-87	REP. CIL. MAESTRO Y DE CLUTCH	86511		33.3 mm 1-5/16"		
		84-87	REP. CIL. MAESTRO Y DE CLUTCH	113441A		33.3 mm 1-5/16"		563
		84-87	REPUESTO FRENO DE DISCO	83297	DEL	85.7 mm 3-3/8"		553
C-35		88-91	CILINDRO DE CLUTCH	37815		20.6 mm 13/16"	NACIONAL	
		88-89	MANGUERA DE FRENOS	36957	DEL DER	23.16"		387
		01-02	MANGUERA DE FRENOS	38267	DEL DER	11.38"		390
		88-89	MANGUERA DE FRENOS	38624	TRAS DER	17.75"		394
		96-00	MANGUERA DE FRENOS	38624	TRAS DER	17.75"		394
		88-89	MANGUERA DE FRENOS	38624	TRAS IZQ	17.75"		394
		96-00	MANGUERA DE FRENOS	38624	TRAS IZQ	17.75"		394
		88-89	MANGUERA DE FRENOS	38662	DEL IZQ	22.25"		395
		88-89	MANGUERA DE FRENOS	38663	DEL DER	22.25"		395
		96-00	MANGUERA DE FRENOS	38808	DEL DER	22.5"		397
		96-00	MANGUERA DE FRENOS	38824	DEL IZQ	23.25"		398
		96-00	MANGUERA DE FRENOS	38872	DEL DER	25.88"		400
		96-00	MANGUERA DE FRENOS	38873	DEL IZQ	25.88"		400
		96-00	MANGUERA DE FRENOS	380469	TRAS DER	10"		421
		01-07	MANGUERA DE FRENOS	381298	DEL IZQ	28.15"		441
		01-07	MANGUERA DE FRENOS	381299	DEL DER	28.15"		441
		01-07	MANGUERA DE FRENOS	381624	TRAS IZQ	12.75"		451
		01-07	MANGUERA DE FRENOS	382399	TRAS DER	22"		464
		01-07	MANGUERA DE FRENOS	382417	DEL IZQ	31.25"		464
		01-07	MANGUERA DE FRENOS	382419	DEL DER	31.25"		465
		96-00	PISTÓN FRENO DE DISCO	76028	DEL Y TRAS	85.7 mm 3-3/8"		518
		88-89	PISTÓN FRENO DE DISCO	85156	DEL	80.2 mm 3-5/32"		520
		01-06	PISTÓN FRENO DE DISCO	85157	DEL	74.6 mm 2-15/16"	CALIPER DOBLE PISTON	520
		96-00	PISTÓN FRENO DE DISCO	85206	DEL	86.1 mm 3-25/64"		521
		03-07	PISTÓN FRENO DE DISCO	85471	DEL Y TRAS	59.5 mm 2-11/32"	CALIPER DOBLE PISTON	524
		01-07	PISTÓN FRENO DE DISCO	854790	DEL Y TRAS	65.9 mm 2-19/32"	CALIPER DOBLE PISTON	535
		01-02	REPUESTO FRENO DE DISCO	2005	DEL	74.6 mm 2-15/16"	CALIPER DOBLE PISTON	538
		04-06	REPUESTO FRENO DE DISCO	2005	DEL	74.6 mm 2-15/16"	CALIPER DOBLE PISTON	538
		96-00	REPUESTO FRENO DE DISCO	2033	DEL	86.1 mm 3-25/64"		538
		88-89	REPUESTO FRENO DE DISCO	2110	DEL	80.2 mm 3-5/32"		539
		01-07	REPUESTO FRENO DE DISCO	2479	DEL Y TRAS	65.9 mm 2-19/32"	CALIPER DOBLE PISTON	
		96-00	REPUESTO FRENO DE DISCO	83297	DEL	85.7 mm 3-3/8"		553
	84-87	CILINDRO DE RUEDA	79767	DER	26.9 mm 1-1/16"		371	
	90-90	CILINDRO DE RUEDA	79767	DER	26.9 mm 1-1/16"		371	
	92-95	CILINDRO DE RUEDA	79767	DER	26.9 mm 1-1/16"		371	
	84-87	CILINDRO DE RUEDA	79767	IZQ	26.9 mm 1-1/16"		371	

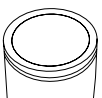



Modelo	Versión	Año	Descripción	Número Lusac	Posición	Diámetro	Notas	Foto Pág.
C-35		90-90	CILINDRO DE RUEDA	79767	IZQ	26.9 mm 1-1/16"		371
		92-95	CILINDRO DE RUEDA	79767	IZQ	26.9 mm 1-1/16"		371
		84-87	CILINDRO DE RUEDA	079768	DER	30.1 mm 1-3/16"		371
		90-00	CILINDRO DE RUEDA	079768	DER	30.1 mm 1-3/16"		371
		84-87	CILINDRO DE RUEDA	079768	IZQ	30.1 mm 1-3/16"		371
		90-00	CILINDRO DE RUEDA	079768	IZQ	30.1 mm 1-3/16"		371
		88-89	CILINDRO DE RUEDA	79794	DER	26.9 mm 1-1/16"		371
		88-94	CILINDRO MAESTRO	39649		1-1/4"	DOBLE RODADA	294
		84-89	CILINDRO MAESTRO	98953		33.3 mm 1-5/16"		297
		84-87	CILINDRO MAESTRO	108145		33.3 mm 1-5/16"		
		91-94	CILINDRO MAESTRO	120590		31.7 mm 1-1/4"	DOBLE RODADA	298
		96-02	CILINDRO MAESTRO	390278		40mm	HEAVY DUTY	307
		95-00	CILINDRO MAESTRO	390279		1-1/4"	DOBLE RODADA	307
		95-95	CILINDRO MAESTRO	390279		1-1/4"	RODADA SENCILLA	307
		99-07	CILINDRO MAESTRO	390542		37mm		318
		03-07	CILINDRO MAESTRO	390818		37mm	HEAVY DUTY	330
		92-00	CILINDRO MAESTRO	18029970		40.0 mm		360
		84-87	MANGUERA DE FRENOS	1198	TRAS DER	14 11/16"		
		84-87	MANGUERA DE FRENOS	1198	TRAS IZQ	14 11/16"		
		84-87	MANGUERA DE FRENOS	36952	DEL IZQ	23.13"		
		84-87	MANGUERA DE FRENOS	36957	DEL DER	23.16"		387
		90-90	MANGUERA DE FRENOS	38267	DEL DER	11.38"		390
		90-90	MANGUERA DE FRENOS	38624	TRAS DER	17.75"		394
		90-90	MANGUERA DE FRENOS	38624	TRAS IZQ	17.75"		394
		92-95	MANGUERA DE FRENOS	38808	DEL DER	22.5"		397
		90-95	MANGUERA DE FRENOS	38823	TRAS DER	22.38"		398
		90-95	MANGUERA DE FRENOS	38823	TRAS IZQ	22.38"		398
		92-95	MANGUERA DE FRENOS	38824	DEL IZQ	23.25"		398
		91-95	MANGUERA DE FRENOS	38872	DEL DER	25.88"		400
		91-95	MANGUERA DE FRENOS	38873	DEL IZQ	25.88"		400
		84-87	PISTÓN FRENO DE DISCO	76028	DEL Y TRAS	85.7 mm 3-3/8"		518
		90-95	PISTÓN FRENO DE DISCO	85156	DEL	80.2 mm 3-5/32"		520
		90-90	PISTÓN FRENO DE DISCO	85206	DEL	86.1 mm 3-25/64"		521
		92-95	PISTÓN FRENO DE DISCO	85206	DEL	86.1 mm 3-25/64"		521
		88-94	REP. CIL. MAESTRO Y DE CLUTCH	39650		31.7 mm 1-1/4"		557
		84-89	REP. CIL. MAESTRO Y DE CLUTCH	86511		33.3 mm 1-5/16"		
		95-00	REP. CIL. MAESTRO Y DE CLUTCH	90279		31.7 mm 1-1/4"		558
		91-94	REP. CIL. MAESTRO Y DE CLUTCH	120591		31.7 mm 1-1/4"		562
		84-87	REP. CIL. MAESTRO Y DE CLUTCH	113441A		33.3 mm 1-5/16"		563
		03-03	REPUESTO FRENO DE DISCO	2005	DEL	74.6 mm 2-15/16"	CALIPER DOBLE PISTON	538
		90-90	REPUESTO FRENO DE DISCO	2033	DEL	86.1 mm 3-25/64"		538
		92-95	REPUESTO FRENO DE DISCO	2033	DEL	86.1 mm 3-25/64"		538
		90-95	REPUESTO FRENO DE DISCO	2110	DEL	80.2 mm 3-5/32"		539
		84-87	REPUESTO FRENO DE DISCO	83297	DEL	85.7 mm 3-3/8"		553
		99-00	REPUESTO FRENO DE DISCO	83297	DEL Y TRAS	85.7 mm 3-3/8"		553

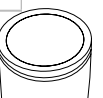



Modelo	Versión	Año	Descripción	Número Lusac	Posición	Diámetro	Notas	Foto Pág.	
CHEVROLET									
C-3500		92-95	CILINDRO DE CLUTCH	350042	SUP	17.7 mm			
		94-95	CILINDRO DE CLUTCH	350182		18.0 mm	NACIONAL		
		94-95	CILINDRO DE CLUTCH	350182		18.0 mm			
		96-00	KIT DE PISTÓN Y REPUESTO FD	742344	DEL	50.8 mm 2"	4X2		
		01-02	MANGUERA DE FRENOS	38267	DEL DER	11.38"		390	
		96-00	MANGUERA DE FRENOS	38624	TRAS DER	17.75"		394	
		96-00	MANGUERA DE FRENOS	38624	TRAS IZQ	17.75"		394	
		96-00	MANGUERA DE FRENOS	38808	DEL DER	22.5"		397	
		96-00	MANGUERA DE FRENOS	38824	DEL IZQ	23.25"		398	
		96-00	MANGUERA DE FRENOS	38872	DEL DER	25.88"		400	
		96-00	MANGUERA DE FRENOS	38873	DEL IZQ	25.88"		400	
		96-00	MANGUERA DE FRENOS	380469	TRAS DER	10"		421	
		01-07	MANGUERA DE FRENOS	381298	DEL IZQ	28.15"		441	
		01-07	MANGUERA DE FRENOS	381299	DEL DER	28.15"		441	
		01-07	MANGUERA DE FRENOS	381624	TRAS IZQ	12.75"		451	
		01-07	MANGUERA DE FRENOS	382399	TRAS DER	22"		464	
		01-07	MANGUERA DE FRENOS	382417	DEL IZQ	31.25"		464	
		01-07	MANGUERA DE FRENOS	382419	DEL DER	31.25"		465	
		96-00	PISTÓN FRENO DE DISCO	76028	DEL Y TRAS	85.7 mm 3-3/8"		518	
		01-06	PISTÓN FRENO DE DISCO	85157	DEL	74.6 mm 2-15/16"	CALIPER DOBLE PISTON	520	
		96-00	PISTÓN FRENO DE DISCO	85206	DEL	86.1 mm 3-25/64"		521	
		03-07	PISTÓN FRENO DE DISCO	85471	DEL Y TRAS	59.5 mm 2-11/32"	CALIPER DOBLE PISTON	524	
		01-07	PISTÓN FRENO DE DISCO	854790	DEL Y TRAS	65.9 mm 2-19/32"	CALIPER DOBLE PISTON	535	
		01-02	REPUESTO FRENO DE DISCO	2005	DEL	74.6 mm 2-15/16"	CALIPER DOBLE PISTON	538	
		04-06	REPUESTO FRENO DE DISCO	2005	DEL	74.6 mm 2-15/16"	CALIPER DOBLE PISTON	538	
		96-00	REPUESTO FRENO DE DISCO	2033	DEL	86.1 mm 3-25/64"		538	
		01-07	REPUESTO FRENO DE DISCO	2479	DEL Y TRAS	65.9 mm 2-19/32"	CALIPER DOBLE PISTON		
		96-00	REPUESTO FRENO DE DISCO	83297	DEL Y TRAS	85.7 mm 3-3/8"		553	
		HD SILVERDAO CLASSIC	99-02	CILINDRO MAESTRO	390278		40mm		307
		HD SILVERDAO CLASSIC	99-02	MANGUERA DE FRENOS	38267	DER	11.38"	S/WRECKER PACKAGE	390
	HD SILVERDAO CLASSIC	99-02	MANGUERA DE FRENOS	38624	CTR	17.75"		394	
	HD SILVERDAO CLASSIC	99-02	MANGUERA DE FRENOS	38872	DER	25.88"		400	
	HD SILVERDAO CLASSIC	99-02	MANGUERA DE FRENOS	38873	IZQ	25.88"		400	
	HD SILVERDAO CLASSIC	99-02	MANGUERA DE FRENOS	380469	DER	10"	WRECKER PACKAGE	421	
	SILVERDAO CLASSIC	99-00	CILINDRO MAESTRO	390279		1-1/4"		307	
	SILVERDAO CLASSIC	99-00	MANGUERA DE FRENOS	38624	CTR	17.75"		394	

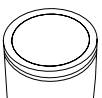



Modelo	Versión	Año	Descripción	Número Lusac	Posición	Diámetro	Notas	Foto Pág.	
C-3500	SILVERDAO CLASSIC	99-00	MANGUERA DE FRENOS	38808	DER	22.5"	DOBLE RODADA	397	
	SILVERDAO CLASSIC	99-00	MANGUERA DE FRENOS	38823	CTR	22.38"		398	
	SILVERDAO CLASSIC	99-00	MANGUERA DE FRENOS	38824	IZQ	23.25"	DOBLE RODADA	398	
	SILVERDAO CLASSIC	99-00	MANGUERA DE FRENOS	380248	IZQ	20.63"	RODADA SENCILLA	410	
	SILVERDAO CLASSIC	99-00	MANGUERA DE FRENOS	380249	DER	20.63"	RODADA SENCILLA	410	
			90-90	CILINDRO DE RUEDA	79767	DER	26.9 mm 1-1/16"		371
			92-95	CILINDRO DE RUEDA	79767	DER	26.9 mm 1-1/16"		371
			90-90	CILINDRO DE RUEDA	79767	IZQ	26.9 mm 1-1/16"		371
			92-95	CILINDRO DE RUEDA	79767	IZQ	26.9 mm 1-1/16"		371
			90-00	CILINDRO DE RUEDA	079768	DER	30.1 mm 1-3/16"		371
			90-00	CILINDRO DE RUEDA	079768	IZQ	30.1 mm 1-3/16"		371
			90-94	CILINDRO MAESTRO	39649		1-1/4"		294
			91-94	CILINDRO MAESTRO	120590		31.7 mm 1-1/4"	DOBLE RODADA	298
			96-02	CILINDRO MAESTRO	390278		40mm	HEAVY DUTY	307
			95-00	CILINDRO MAESTRO	390279		1-1/4"	DOBLE RODADA	307
			99-07	CILINDRO MAESTRO	390542		37mm		318
			03-07	CILINDRO MAESTRO	390818		37mm	HEAVY DUTY	330
			92-00	CILINDRO MAESTRO	18029970		40.0 mm		360
			90-90	MANGUERA DE FRENOS	38267	DEL DER	11.38"		390
			01-02	MANGUERA DE FRENOS	38267	DEL DER	11.38"		390
			90-90	MANGUERA DE FRENOS	38624	TRAS DER	17.75"		394
			96-00	MANGUERA DE FRENOS	38624	TRAS DER	17.75"		394
			90-90	MANGUERA DE FRENOS	38624	TRAS IZQ	17.75"		394
			96-00	MANGUERA DE FRENOS	38624	TRAS IZQ	17.75"		394
			92-00	MANGUERA DE FRENOS	38808	DEL DER	22.5"		397
			90-95	MANGUERA DE FRENOS	38823	TRAS DER	22.38"		398
			90-95	MANGUERA DE FRENOS	38823	TRAS IZQ	22.38"		398
			92-00	MANGUERA DE FRENOS	38824	DEL IZQ	23.25"		398
			91-00	MANGUERA DE FRENOS	38872	DEL DER	25.88"		400
			91-00	MANGUERA DE FRENOS	38873	DEL IZQ	25.88"		400
			96-00	MANGUERA DE FRENOS	380469	TRAS DER	10"		421
			01-02	MANGUERA DE FRENOS	381298	DEL IZQ	28.15"		441
			01-02	MANGUERA DE FRENOS	381299	DEL DER	28.15"		441
			01-02	MANGUERA DE FRENOS	381624	TRAS IZQ	12.75"		451
			01-02	MANGUERA DE FRENOS	382399	TRAS DER	22"		464
			01-02	MANGUERA DE FRENOS	382417	DEL IZQ	31.25"		464
			01-02	MANGUERA DE FRENOS	382419	DEL DER	31.25"		465
			96-00	PISTÓN FRENO DE DISCO	76028	DEL Y TRAS	85.7 mm 3-3/8"		518
			90-95	PISTÓN FRENO DE DISCO	85156	DEL	80.2 mm 3-5/32"		520
			01-02	PISTÓN FRENO DE DISCO	85157	DEL	74.6 mm 2-15/16"	CALIPER DOBLE PISTON	520
			90-90	PISTÓN FRENO DE DISCO	85206	DEL	86.1 mm 3-25/64"		521
			92-00	PISTÓN FRENO DE DISCO	85206	DEL	86.1 mm 3-25/64"		521
		01-02	PISTÓN FRENO DE DISCO	854790	DEL Y TRAS	65.9 mm 2-19/32"	CALIPER DOBLE PISTON	535	
		90-90	REP. CIL. MAESTRO Y DE CLUTCH	39650		31.7 mm 1-1/4"		557	
		90-94	REP. CIL. MAESTRO Y DE CLUTCH	39650		31.7 mm 1-1/4"		557	





Modelo	Versión	Año	Descripción	Número Lusac	Posición	Diámetro	Notas	Foto Pág.
CHEVROLET								
C-3500		95-00	REP. CIL. MAESTRO Y DE CLUTCH	90279		31.7 mm 1-1/4"		558
		91-94	REP. CIL. MAESTRO Y DE CLUTCH	120591		31.7 mm 1-1/4"		562
		01-03	REPUESTO FRENO DE DISCO	2005	DEL	74.6 mm 2-15/16"	CALIPER DOBLE PISTON	538
		90-90	REPUESTO FRENO DE DISCO	2033	DEL	86.1 mm 3-25/64"		538
		92-00	REPUESTO FRENO DE DISCO	2033	DEL	86.1 mm 3-25/64"		538
		90-95	REPUESTO FRENO DE DISCO	2110	DEL	80.2 mm 3-5/32"		539
		01-02	REPUESTO FRENO DE DISCO	2479	DEL Y TRAS	65.9 mm 2-19/32"	CALIPER DOBLE PISTON	
		96-00	REPUESTO FRENO DE DISCO	83297	DEL Y TRAS	85.7 mm 3-3/8"		553
		01-02	MANGUERA DE FRENOS	38267	DEL DER	11.38"	DS HD	390
	HD	96-00	MANGUERA DE FRENOS	38624	TRAS DER	17.75"		394
	HD	96-00	MANGUERA DE FRENOS	38624	TRAS IZQ	17.75"		394
		96-00	MANGUERA DE FRENOS	38808	DEL DER	22.5"	DS HD	397
		96-00	MANGUERA DE FRENOS	38824	DEL IZQ	23.25"	DS HD	398
		96-00	MANGUERA DE FRENOS	38872	DEL DER	25.88"	DS HD	400
		96-00	MANGUERA DE FRENOS	38873	DEL IZQ	25.88"	DS HD	400
		96-00	MANGUERA DE FRENOS	380469	TRAS DER	10"	DS HD	421
		01-07	MANGUERA DE FRENOS	381298	DEL IZQ	28.15"	DS HD	441
		01-07	MANGUERA DE FRENOS	381299	DEL DER	28.15"	DS HD	441
		01-07	MANGUERA DE FRENOS	381624	TRAS IZQ	12.75"	DS HD	451
		01-07	MANGUERA DE FRENOS	382399	TRAS DER	22"	DS HD	464
		01-07	MANGUERA DE FRENOS	382417	DEL IZQ	31.25"	DS HD	464
		01-07	MANGUERA DE FRENOS	382419	DEL DER	31.25"	DS HD	465
		96-00	PISTÓN FRENO DE DISCO	76028	DEL Y TRAS	85.7 mm 3-3/8"	HD	518
		01-06	PISTÓN FRENO DE DISCO	85157	DEL	74.6 mm 2-15/16"	CALIPER DOBLE PISTON HD	520
		96-00	PISTÓN FRENO DE DISCO	85206	DEL	86.1 mm 3-25/64"	HD	521
		03-07	PISTÓN FRENO DE DISCO	85471	DEL Y TRAS	59.5 mm 2-11/32"	CALIPER DOBLE PISTON HD	524
		01-07	PISTÓN FRENO DE DISCO	854790	DEL Y TRAS	65.9 mm 2-19/32"	CALIPER DOBLE PISTON HD	535
		01-02	REPUESTO FRENO DE DISCO	2005	DEL	74.6 mm 2-15/16"	CALIPER DOBLE PISTON HD	538
		04-06	REPUESTO FRENO DE DISCO	2005	DEL	74.6 mm 2-15/16"	CALIPER DOBLE PISTON HD	538
		96-00	REPUESTO FRENO DE DISCO	2033	DEL	86.1 mm 3-25/64"	HD	538
		01-07	REPUESTO FRENO DE DISCO	2479	DEL Y TRAS	65.9 mm 2-19/32"	CALIPER DOBLE PISTON HD	
		96-00	REPUESTO FRENO DE DISCO	83297	DEL Y TRAS	85.7 mm 3-3/8"	HD	553
		96-00	CILINDRO DE RUEDA	079768	DER	30.1 mm 1-3/16"	HD	371
		96-00	CILINDRO DE RUEDA	079768	IZQ	30.1 mm 1-3/16"	HD	371
		96-02	CILINDRO MAESTRO	390278		40mm	HEAVY DUTY HD	307
		96-00	CILINDRO MAESTRO	390279		1-1/4"	DOBLE RODADA HD	307
		99-07	CILINDRO MAESTRO	390542		37mm	HD	318
		03-07	CILINDRO MAESTRO	390818		37mm	HEAVY DUTY HD	330
		96-00	CILINDRO MAESTRO	18029970		40.0 mm	HD	360
		01-02	MANGUERA DE FRENOS	38267	DEL DER	11.38"	DS HD	390
		96-00	MANGUERA DE FRENOS	38624	TRAS DER	17.75"	HD	394

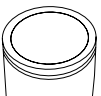

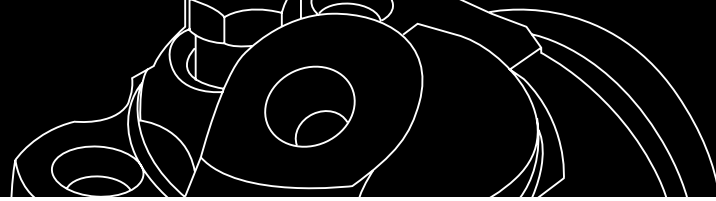

Modelo	Versión	Año	Descripción	Número Lusac	Posición	Diámetro	Notas	Foto Pág.
C-3500		96-00	MANGUERA DE FRENOS	38624	TRAS IZQ	17.75"	HD	394
		96-00	MANGUERA DE FRENOS	38808	DEL DER	22.5"	DS HD	397
		96-00	MANGUERA DE FRENOS	38824	DEL IZQ	23.25"	DS HD	398
		96-00	MANGUERA DE FRENOS	38872	DEL DER	25.88"	DS HD	400
		96-00	MANGUERA DE FRENOS	38873	DEL IZQ	25.88"	DS HD	400
		96-00	MANGUERA DE FRENOS	380469	TRAS DER	10"	DS HD	421
		01-02	MANGUERA DE FRENOS	381298	DEL IZQ	28.15"	DS HD	441
		01-02	MANGUERA DE FRENOS	381299	DEL DER	28.15"	DS HD	441
		01-02	MANGUERA DE FRENOS	381624	TRAS IZQ	12.75"	DS HD	451
		01-02	MANGUERA DE FRENOS	382399	TRAS DER	22"	DS HD	464
		01-02	MANGUERA DE FRENOS	382417	DEL IZQ	31.25"	DS HD	464
		01-02	MANGUERA DE FRENOS	382419	DEL DER	31.25"	DS HD	465
		96-00	PISTÓN FRENO DE DISCO	76028	DEL Y TRAS	85.7 mm 3-3/8"	HD	518
		01-02	PISTÓN FRENO DE DISCO	85157	DEL	74.6 mm 2-15/16"	CALIPER DOBLE PISTON HD	520
		96-00	PISTÓN FRENO DE DISCO	85206	DEL	86.1 mm 3-25/64"	HD	521
		01-02	PISTÓN FRENO DE DISCO	854790	DEL Y TRAS	65.9 mm 2-19/32"	CALIPER DOBLE PISTON HD	535
		96-00	REP. CIL. MAESTRO Y DE CLUTCH	90279		31.7 mm 1-1/4"	HD	558
		01-03	REPUESTO FRENO DE DISCO	2005	DEL	74.6 mm 2-15/16"	CALIPER DOBLE PISTON HD	538
		96-00	REPUESTO FRENO DE DISCO	2033	DEL	86.1 mm 3-25/64"	HD	538
		01-02	REPUESTO FRENO DE DISCO	2479	DEL Y TRAS	65.9 mm 2-19/32"	CALIPER DOBLE PISTON HD	
		96-00	REPUESTO FRENO DE DISCO	83297	DEL Y TRAS	85.7 mm 3-3/8"	HD	553
		03-07	MANGUERA DE FRENOS	381298	DEL IZQ	28.15"	DS SILVERADO	441
		03-07	MANGUERA DE FRENOS	381299	DEL DER	28.15"	DS SILVERADO	441
		03-10	MANGUERA DE FRENOS	381624	TRAS IZQ	12.75"	DS SILVERADO	451
		07-10	MANGUERA DE FRENOS	382363	TRAS IZQ	22"	DS SILVERADO	460
		07-10	MANGUERA DE FRENOS	382364	TRAS DER	20.38"	DS SILVERADO	460
		03-10	MANGUERA DE FRENOS	382399	TRAS DER	22"	DS SILVERADO	464
		03-07	MANGUERA DE FRENOS	382417	DEL IZQ	31.25"	DS SILVERADO	464
		03-07	MANGUERA DE FRENOS	382419	DEL DER	31.25"	DS SILVERADO	465
		03-08	PISTÓN FRENO DE DISCO	85157	DEL	74.6 mm 2-15/16"	CALIPER DOBLE PISTON SILVERADO	520
		03-08	PISTÓN FRENO DE DISCO	85471	DEL Y TRAS	59.5 mm 2-11/32"	CALIPER DOBLE PISTON SILVERADO	524
		03-07	PISTÓN FRENO DE DISCO	854790	DEL Y TRAS	65.9 mm 2-19/32"	CALIPER DOBLE PISTON SILVERADO	535
		04-08	REPUESTO FRENO DE DISCO	2005	DEL	74.6 mm 2-15/16"	CALIPER DOBLE PISTON SILVERADO	538
		03-07	REPUESTO FRENO DE DISCO	2479	DEL Y TRAS	65.9 mm 2-19/32"	CALIPER DOBLE PISTON SILVERADO	
		03-07	CILINDRO MAESTRO	390542		37mm		318
		03-07	CILINDRO MAESTRO	390818		37mm	HEAVY DUTY SILVERADO	330
		07-08	CILINDRO MAESTRO	391082		37mm	HEAVY DUTY SILVERADO	342
		09-13	CILINDRO MAESTRO	391183		1-1/2"	DOBLE RODADA SILVERADO	347
		11-13	CILINDRO MAESTRO	391184		1-1/2"	RODADA SENCILLA SILVERADO	347
		03-03	REPUESTO FRENO DE DISCO	2005	DEL	74.6 mm 2-15/16"	CALIPER DOBLE PISTON SILVERADO	538
		01-03	CILINDRO MAESTRO	390278		40mm	HEAVY DUTY	307





Modelo	Versión	Año	Descripción	Número Lusac	Posición	Diámetro	Notas	Foto Pág.
CHEVROLET								
C-36		01-03	PISTÓN FRENO DE DISCO	854790	DEL Y TRAS	65.9 mm 2-19/32"	CALIPER DOBLE PISTON	535
		01-03	REPUESTO FRENO DE DISCO	2479	DEL Y TRAS	65.9 mm 2-19/32"	CALIPER DOBLE PISTON	
		01-03	CILINDRO MAESTRO	390278		40mm	HEAVY DUTY HD	307
		01-03	PISTÓN FRENO DE DISCO	854790	DEL Y TRAS	65.9 mm 2-19/32"	CALIPER DOBLE PISTON HD	535
		01-03	REPUESTO FRENO DE DISCO	2479	DEL Y TRAS	65.9 mm 2-19/32"	CALIPER DOBLE PISTON HD	
C70		88-89	CILINDRO MAESTRO	390325		50.8 mm 2"		309
CAMARO		95-97	MANGUERA DE FRENOS	380406	DEL DER	12.5"		419
		95-97	MANGUERA DE FRENOS	380406	DEL IZQ	12.5"		419
		95-97	MANGUERA DE FRENOS	380483	TRAS DER	7.75"		422
		95-97	MANGUERA DE FRENOS	380483	TRAS IZQ	7.75"		422
		95-97	REPUESTO FRENO DE DISCO	99024	DEL	63.5 mm 2-1/2"		553
	Z28	98-02	MANGUERA DE FRENOS	380483	TRAS DER	7.75"		422
	Z28	98-02	MANGUERA DE FRENOS	380483	TRAS IZQ	7.75"		422
	Z28	98-02	PISTÓN FRENO DE DISCO	85275	DEL	45.0 mm	CALIPER DOBLE PISTON	522
	Z28	98-02	PISTÓN FRENO DE DISCO	85488	TRAS	45.0 mm		525
	Z28	98-02	REPUESTO FRENO DE DISCO	2275	DEL	45.0 mm	CALIPER DOBLE PISTON	541
	95-02	CILINDRO DE CLUTCH	350014		19.0 mm 3/4"			
	95-97	CILINDRO MAESTRO	390214		1"		303	
CAPTIVA		08-14	MANGUERA DE FRENOS	382700	DEL IZQ	18.81"		483
		08-14	MANGUERA DE FRENOS	382701	DEL DER	18.81"		483
		08-14	PISTÓN FRENO DE DISCO	851028	DEL	45.0mm		532
		08-14	REPUESTO FRENO DE DISCO	21989	DEL	45.0mm		551
		08-14	CILINDRO MAESTRO	391145		1"		344
	SPORT	08-14	KIT DE PISTÓN Y REPUESTO FD	742422	DEL	45.0 mm		
CARGO VAN 3500		97-02	CILINDRO DE RUEDA	79767	DER	26.9 mm 1-1/16"		371
		97-02	CILINDRO DE RUEDA	79767	IZQ	26.9 mm 1-1/16"		371
		97-02	MANGUERA DE FRENOS	38624	TRAS DER	17.75"		394
		97-02	MANGUERA DE FRENOS	38624	TRAS IZQ	17.75"		394
		97-03	MANGUERA DE FRENOS	380587	DEL DER	21.33"		426
		97-03	MANGUERA DE FRENOS	380588	DEL IZQ	21.33"		426
		97-03	MANGUERA DE FRENOS	382319	DEL IZQ	25"		456
		97-03	MANGUERA DE FRENOS	382320	DEL DER	24.75"		456
		97-02	PISTÓN FRENO DE DISCO	85156	DEL	80.2 mm 3-5/32"		520
		03-03	PISTÓN FRENO DE DISCO	851010	TRAS	50.8 mm 2"		530
		01-03	PISTÓN FRENO DE DISCO	851070	DEL	57.1 mm 2-1/4"	CALIPER DOBLE PISTON	533
		03-03	PISTÓN FRENO DE DISCO	851110	TRAS	44.4 mm 1-3/4"	CALIPER DOBLE PISTON	534
		01-03	REPUESTO FRENO DE DISCO	2107	DEL	57.1 mm 2-1/4"	CALIPER DOBLE PISTON	539
		97-02	REPUESTO FRENO DE DISCO	2110	DEL	80.2 mm 3-5/32"		539
		03-03	REPUESTO FRENO DE DISCO	2111	TRAS	44.4 mm 1-3/4"	CALIPER DOBLE PISTON	
	03-03	REPUESTO FRENO DE DISCO	21010	TRAS	50.8 mm 2"		546	

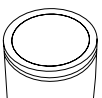



Modelo	Versión	Año	Descripción	Número Lusac	Posición	Diámetro	Notas	Foto Pág.
CARGO VAN 3500		97-00	CILINDRO DE RUEDA	116359	DER	25.4 mm 1"		373
		97-00	CILINDRO DE RUEDA	116359	IZQ	25.4 mm 1"		373
		97-03	CILINDRO MAESTRO	390364		1-1/4"		310
		03-03	CILINDRO MAESTRO	391026		37mm		340
CAVALIER		90-91	MANGUERA DE FRENOS	4222	DEL IZQ	13"		386
		90-91	MANGUERA DE FRENOS	4223	DEL DER	12"		386
		90-04	MANGUERA DE FRENOS	38081	TRAS DER	7.5"		388
		90-04	MANGUERA DE FRENOS	38081	TRAS IZQ	7.5"		388
		92-94	MANGUERA DE FRENOS	38905	DEL DER	17.88"		402
		92-94	MANGUERA DE FRENOS	38906	DEL IZQ	17.88"		402
		95-04	MANGUERA DE FRENOS	380467	DEL DER	12.5"		421
		95-04	MANGUERA DE FRENOS	380467	DEL IZQ	12.5"		421
		92-04	PISTÓN FRENO DE DISCO	85389	DEL	57.1 mm 2-1/4"		523
		90-91	PISTÓN FRENO DE DISCO	100799	DEL	57.1 mm 2-1/4"		528
		90-04	REPUESTO FRENO DE DISCO	100797	DEL	57.1 mm 2-1/4"		553
	Z-24	92-96	CILINDRO DE RUEDA	0116366	DER	17.4 mm 11/16"		373
	Z-24	92-96	CILINDRO DE RUEDA	0116366	IZQ	17.4 mm 11/16"		373
	Z-24	91-91	CILINDRO DE RUEDA	116384	DER	16.0 mm		374
	Z-24	91-91	CILINDRO DE RUEDA	116384	IZQ	16.0 mm		374
	Z-24	91-91	CILINDRO MAESTRO	114190		22.2 mm 7/8"	2.4 LTS	298
	Z-24	92-94	CILINDRO MAESTRO	390174		7/8"	2.4 LTS	302
	Z-24	95-96	CILINDRO MAESTRO	390277		7/8"	2.4 LTS	307
	Z-24	91-91	MANGUERA DE FRENOS	4222	DEL IZQ	13"		386
	Z-24	91-91	MANGUERA DE FRENOS	4223	DEL DER	12"		386
	Z-24	91-96	MANGUERA DE FRENOS	38081	TRAS DER	7.5"		388
	Z-24	91-96	MANGUERA DE FRENOS	38081	TRAS IZQ	7.5"		388
	Z-24	92-94	MANGUERA DE FRENOS	38905	DEL DER	17.88"		402
	Z-24	92-94	MANGUERA DE FRENOS	38906	DEL IZQ	17.88"		402
	Z-24	95-96	MANGUERA DE FRENOS	380467	DEL DER	12.5"		421
	Z-24	95-96	MANGUERA DE FRENOS	380467	DEL IZQ	12.5"		421
	Z-24	92-96	PISTÓN FRENO DE DISCO	85389	DEL	57.1 mm 2-1/4"		523
	Z-24	91-91	PISTÓN FRENO DE DISCO	100799	DEL	57.1 mm 2-1/4"		528
	Z-24	91-96	REP. CIL. MAESTRO Y DE CLUTCH	114191		22.2 mm 7/8"		561
	Z-24	91-96	REPUESTO FRENO DE DISCO	100797	DEL	57.1 mm 2-1/4"		553
		90-92	CILINDRO DE CLUTCH	360000	INF	31.7 mm 1-1/4"		
		00-05	CILINDRO DE CLUTCH	360111		N.R.		
		95-02	CILINDRO DE RUEDA	112341	DER	22.2 mm 7/8"		373
		95-02	CILINDRO DE RUEDA	112341	IZQ	22.2 mm 7/8"		373
		92-02	CILINDRO DE RUEDA	0116366	DER	17.4 mm 11/16"		373
		92-02	CILINDRO DE RUEDA	0116366	IZQ	17.4 mm 11/16"		373
		90-91	CILINDRO DE RUEDA	116384	DER	16.0 mm		374
		90-91	CILINDRO DE RUEDA	116384	IZQ	16.0 mm		374
		03-04	CILINDRO DE RUEDA	370133	IZQ	11/16"		378
		90-91	CILINDRO MAESTRO	114190		22.2 mm 7/8"	2.8, 3.1 LTS	298
	92-94	CILINDRO MAESTRO	390174		7/8"	3.1 LTS	302	
	95-99	CILINDRO MAESTRO	390277		7/8"		307	
	95-99	CILINDRO MAESTRO	390277		7/8"	2.2 LTS	307	
	00-02	CILINDRO MAESTRO	390646		7/8"		321	
	00-04	CILINDRO MAESTRO	390646		7/8"	2.2 LTS	321	





Modelo	Versión	Año	Descripción	Número Lusac	Posición	Diámetro	Notas	Foto Pág.
CHEVROLET								
CAVALIER		90-04	REP. CIL. MAESTRO Y DE CLUTCH	114191		22.2 mm 7/8"		561
CELEBRITY		85-89	MANGUERA DE FRENOS	2025	TRAS DER	8"		385
CHEVELLE		85-89	MANGUERA DE FRENOS	2025	TRAS IZQ	8"		385
		85-89	MANGUERA DE FRENOS	4051	DEL IZQ	16 1/16"		386
		85-89	MANGUERA DE FRENOS	4068	DEL DER	17 5/8"		386
		85-89	PISTÓN FRENO DE DISCO	100799	DEL	57.1 mm 2-1/4"		528
		85-91	CILINDRO DE CLUTCH	360002	INF	31.7 mm 1-1/4"		
		85-86	CILINDRO DE RUEDA	104384	DER	17.4 mm 11/16"		372
		85-86	CILINDRO DE RUEDA	104384	IZQ	17.4 mm 11/16"		372
		87-89	CILINDRO DE RUEDA	0116366	DER	17.4 mm 11/16"		373
		87-89	CILINDRO DE RUEDA	0116366	IZQ	17.4 mm 11/16"		373
		87-89	CILINDRO MAESTRO	114192		24.0 mm		298
		85-86	REP. CIL. MAESTRO Y DE CLUTCH	107056		24.0 mm		560
		87-89	REP. CIL. MAESTRO Y DE CLUTCH	114196		24.0 mm		561
		79-81	KIT DE PISTÓN Y REPUESTO FD	742367	DEL	63.5 mm 2-1/2"		
CHEVY	INC POP, MONZA, PICK UP	94-98	MANGUERA DE FRENOS	38657	DEL IZQ	13.75"		395
	INC POP, MONZA, PICK UP	94-98	MANGUERA DE FRENOS	38658	TRAS IZQ	9.5"		395
	INC POP, MONZA, PICK UP	94-98	PISTÓN FRENO DE DISCO	832	DEL	48.0 mm 1-57/64"		517
	INC POP, MONZA, PICK UP	94-98	REPUESTO FRENO DE DISCO	124	DEL	48.0 mm 1-57/64"		536
	C2	04-12	CILINDRO DE RUEDA	844	DER	19.0 mm 3/4"		364
	C2	04-12	CILINDRO DE RUEDA	844	IZQ	19.0 mm 3/4"		364
	C2	04-12	CILINDRO MAESTRO	39009902		20.6 mm 13/16"	1.6 LTS	360
	C2	04-12	MANGUERA DE FRENOS	38657	DEL IZQ	13.75"		395
	C2	04-12	MANGUERA DE FRENOS	38658	TRAS IZQ	9.5"		395
	C2	04-12	PISTÓN FRENO DE DISCO	832	DEL	48.0 mm 1-57/64"		517
	C2	04-12	REPUESTO FRENO DE DISCO	124	DEL	48.0 mm 1-57/64"		536
	INC POP, MONZA, PICK UP	99-99	MANGUERA DE FRENOS	38657	DEL IZQ	13.75"		395
	INC POP, MONZA, PICK UP	99-99	MANGUERA DE FRENOS	38658	TRAS IZQ	9.5"		395
	INC POP, MONZA, PICK UP	99-99	PISTÓN FRENO DE DISCO	832	DEL	48.0 mm 1-57/64"		517
	INC POP, MONZA, PICK UP	99-99	REPUESTO FRENO DE DISCO	124	DEL	48.0 mm 1-57/64"		536
	INC POP, MONZA, VAGONETA	00-00	CILINDRO DE RUEDA	834	DER	19.0 mm 3/4"	EN ESTOS AÑOS TAMBIÉN PUEDE LLEVAR EL CILINDRO 844	364
	INC POP, MONZA, VAGONETA	00-00	CILINDRO DE RUEDA	834	IZQ	19.0 mm 3/4"	EN ESTOS AÑOS TAMBIÉN PUEDE LLEVAR EL CILINDRO 844	364

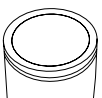



Modelo	Versión	Año	Descripción	Número Lusac	Posición	Diámetro	Notas	Foto Pág.
CHEVY	INC POP, MONZA, VAGONETA	00-00	CILINDRO MAESTRO	390801RL		20.6 mm 13/16"		362
	INC. MONZA, POP, VAGONETA, PICK UP	00-03	MANGUERA DE FRENOS	38657	DEL IZQ	13.75"		395
	INC. MONZA, POP, VAGONETA, PICK UP	00-03	MANGUERA DE FRENOS	38658	TRAS IZQ	9.5"		395
	INC. MONZA, POP, VAGONETA, PICK UP	00-03	PISTÓN FRENO DE DISCO	832	DEL	48.0 mm 1-57/64"		517
	INC. MONZA, POP, VAGONETA, PICK UP	00-03	REPUESTO FRENO DE DISCO	124	DEL	48.0 mm 1-57/64"		536
	JOY, SWING	94-99	CILINDRO DE RUEDA	834	DER	19.0 mm 3/4"	EN ESTOS AÑOS TAMBIÉN PUEDE LLEVAR EL CILINDRO 844	364
	JOY, SWING	94-99	CILINDRO DE RUEDA	834	IZQ	19.0 mm 3/4"	EN ESTOS AÑOS TAMBIÉN PUEDE LLEVAR EL CILINDRO 844	364
	JOY, SWING	94-98	CILINDRO MAESTRO	390801RL		20.6 mm 13/16"		362
	JOY, SWING	94-98	REP. CIL. MAESTRO Y DE CLUTCH	830		20.6 mm 13/16"		557
	JOY, SWING, POP, MONZA, PICK UP	01-01	CILINDRO DE RUEDA	834	IZQ	19.0 mm 3/4"	EN ESTOS AÑOS TAMBIÉN PUEDE LLEVAR EL CILINDRO 844	364
	JOY, SWING, POP, MONZA, PICK UP	99-99	CILINDRO MAESTRO	390801RL		20.6 mm 13/16"		362
	JOY, SWING, POP, MONZA, PICK UP	99-99	REP. CIL. MAESTRO Y DE CLUTCH	830		20.6 mm 13/16"		557
	JOY, SWING, POP, MONZA, PICK UP	03-03	REP. CIL. MAESTRO Y DE CLUTCH	830		20.6 mm 13/16"		557
	JOY, SWING, POP, MONZA, VAGONETA	01-03	CILINDRO DE RUEDA	834	DER	19.0 mm 3/4"	EN ESTOS AÑOS TAMBIÉN PUEDE LLEVAR EL CILINDRO 844	364
	JOY, SWING, POP, MONZA, VAGONETA	02-03	CILINDRO DE RUEDA	834	IZQ	19.0 mm 3/4"	EN ESTOS AÑOS TAMBIÉN PUEDE LLEVAR EL CILINDRO 844	364
	JOY, SWING, POP, MONZA, VAGONETA	01-03	CILINDRO MAESTRO	390801RL		20.6 mm 13/16"		362
	JOY, SWING, POP, MONZA, VAGONETA	00-02	REP. CIL. MAESTRO Y DE CLUTCH	830		20.6 mm 13/16"		557
	MONZA	97-03	CILINDRO DE RUEDA	834	DER	19.0 mm 3/4"	EN ESTOS AÑOS TAMBIÉN PUEDE LLEVAR EL CILINDRO 844	364





Modelo	Versión	Año	Descripción	Número Lusac	Posición	Diámetro	Notas	Foto Pág.
CHEVROLET								
CHEVY	MONZA	97-03	CILINDRO DE RUEDA	834	IZQ	19.0 mm 3/4"	EN ESTOS AÑOS TAMBIÉN PUEDE LLEVAR EL CILINDRO 844	364
	MONZA	97-03	CILINDRO MAESTRO	390801RL		20.6 mm 13/16"		362
	MONZA	97-03	MANGUERA DE FRENOS	38657	DEL IZQ	13.75"		395
	MONZA	97-03	MANGUERA DE FRENOS	38658	TRAS IZQ	9.5"		395
	MONZA	97-03	PISTÓN FRENO DE DISCO	832	DEL	48.0 mm 1-57/64"		517
	MONZA	97-03	REP. CIL. MAESTRO Y DE CLUTCH	830		20.6 mm 13/16"		557
	MONZA	97-03	REPUESTO FRENO DE DISCO	124	DEL	48.0 mm 1-57/64"		536
	PICK UP	99-03	CILINDRO DE RUEDA	370382	DER	22.0 mm		383
	PICK UP	99-03	CILINDRO DE RUEDA	370384	IZQ	22.0 mm		383
	PICK UP	99-03	CILINDRO MAESTRO	39009902		20.6 mm 13/16"		360
	PICK UP	99-99	CILINDRO MAESTRO	390801RL		20.6 mm 13/16"		362
	PICK UP	99-03	MANGUERA DE FRENOS	38657	DEL DER	13.75"		395
	PICK UP	99-03	MANGUERA DE FRENOS	38657	DEL IZQ	13.75"		395
	PICK UP	99-03	MANGUERA DE FRENOS	38658	TRAS IZQ	9.5"		395
	PICK UP	99-03	PISTÓN FRENO DE DISCO	832	DEL	48.0 mm 1-57/64"		517
	PICK UP	99-99	REP. CIL. MAESTRO Y DE CLUTCH	830		20.6 mm 13/16"		557
	PICK UP	99-03	REPUESTO FRENO DE DISCO	124	DEL	48.0 mm 1-57/64"		536
	POP	96-03	CILINDRO DE RUEDA	834	DER	19.0 mm 3/4"	EN ESTOS AÑOS TAMBIÉN PUEDE LLEVAR EL CILINDRO 844	364
	POP	96-03	CILINDRO DE RUEDA	834	IZQ	19.0 mm 3/4"	EN ESTOS AÑOS TAMBIÉN PUEDE LLEVAR EL CILINDRO 844	364
	POP	96-03	CILINDRO MAESTRO	390801RL		20.6 mm 13/16"		362
POP	96-03	MANGUERA DE FRENOS	38657	DEL IZQ	13.75"		395	
POP	96-03	MANGUERA DE FRENOS	38658	TRAS IZQ	9.5"		395	
POP	96-03	PISTÓN FRENO DE DISCO	832	DEL	48.0 mm 1-57/64"		517	
POP	96-03	REP. CIL. MAESTRO Y DE CLUTCH	830		20.6 mm 13/16"		557	
POP	96-03	REPUESTO FRENO DE DISCO	124	DEL	48.0 mm 1-57/64"		536	
VAGONETA	00-03	CILINDRO DE RUEDA	834	DER	19.0 mm 3/4"	EN ESTOS AÑOS TAMBIÉN PUEDE LLEVAR EL CILINDRO 844	364	
VAGONETA	00-03	CILINDRO DE RUEDA	834	IZQ	19.0 mm 3/4"	EN ESTOS AÑOS TAMBIÉN PUEDE LLEVAR EL CILINDRO 844	364	
VAGONETA	00-03	CILINDRO MAESTRO	390801RL		20.6 mm 13/16"		362	
VAGONETA	00-03	MANGUERA DE FRENOS	38657	DEL IZQ	13.75"		395	
VAGONETA	00-03	MANGUERA DE FRENOS	38658	TRAS IZQ	9.5"		395	
VAGONETA	00-03	PISTÓN FRENO DE DISCO	832	DEL	48.0 mm 1-57/64"		517	
VAGONETA	00-03	REP. CIL. MAESTRO Y DE CLUTCH	830		20.6 mm 13/16"		557	
VAGONETA	00-03	REPUESTO FRENO DE DISCO	124	DEL	48.0 mm 1-57/64"		536	
		94-10	KIT DE PISTÓN Y REPUESTO FD	742356	DEL	48.0 mm 1-57/64"		

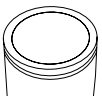



Modelo	Versión	Año	Descripción	Número Lusac	Posición	Diámetro	Notas	Foto Pág.
CHEVY PICKUP		07-10	KIT DE PISTÓN Y REPUESTO FD	742356	DEL	48.0 mm 1-57/64"		
		99-04	KIT DE PISTÓN Y REPUESTO FD	742356	DEL	48.0 mm 1-57/64"		
CHEYENNE		92-00	MANGUERA DE FRENOS	38620	DEL IZQ	25.13"		394
		92-00	MANGUERA DE FRENOS	38621	DEL DER	25.13"		394
		92-00	MANGUERA DE FRENOS	38624	TRAS DER	17.75"		394
		92-00	MANGUERA DE FRENOS	38624	TRAS IZQ	17.75"		394
		02-04	MANGUERA DE FRENOS	381272	TRAS IZQ	22.5"		439
		06-07	MANGUERA DE FRENOS	381272	TRAS IZQ	22.5"		439
		06-07	MANGUERA DE FRENOS	381298	DEL IZQ	28.15"		441
		06-07	MANGUERA DE FRENOS	381299	DEL DER	28.15"		441
		02-04	MANGUERA DE FRENOS	382396	TRAS IZQ	16.38"		463
		06-07	MANGUERA DE FRENOS	382396	TRAS IZQ	16.38"		463
		02-04	MANGUERA DE FRENOS	382398	TRAS DER	17.19"		463
		06-07	MANGUERA DE FRENOS	382398	TRAS DER	17.19"		463
		02-04	MANGUERA DE FRENOS	382412	DEL IZQ	28.38"		464
		02-04	MANGUERA DE FRENOS	382414	DEL DER	27.38"		464
		02-04	PISTÓN FRENO DE DISCO	2160	DEL	50.8 mm 2"	CALIPER DOBLE PISTON	517
		06-07	PISTÓN FRENO DE DISCO	2160	DEL	50.8 mm 2"	CALIPER DOBLE PISTON	517
		92-00	PISTÓN FRENO DE DISCO	85157	DEL	74.6 mm 2-15/16"		520
		92-00	REPUESTO FRENO DE DISCO	2005	DEL	74.6 mm 2-15/16"		538
		02-04	REPUESTO FRENO DE DISCO	2159	TRAS	50.8 mm 2"	CALIPER DOBLE PISTON	540
		06-07	REPUESTO FRENO DE DISCO	2159	DEL	50.8 mm 2"	CALIPER DOBLE PISTON	540
		94-00	CILINDRO DE RUEDA	116224	DER	30.1 mm 1-3/16"		373
		94-00	CILINDRO DE RUEDA	116224	IZQ	30.1 mm 1-3/16"		373
		94-94	CILINDRO DE RUEDA	116263	DER	28.5 mm 1-1/8"		373
		96-00	CILINDRO DE RUEDA	116263	DER	28.5 mm 1-1/8"		373
		94-94	CILINDRO DE RUEDA	116263	IZQ	28.5 mm 1-1/8"		373
		96-00	CILINDRO DE RUEDA	116263	IZQ	28.5 mm 1-1/8"		373
		92-95	CILINDRO DE RUEDA	116359	DER	25.4 mm 1"		373
		92-95	CILINDRO DE RUEDA	116359	IZQ	25.4 mm 1"		373
		02-04	CILINDRO DE RUEDA	370180	IZQ	15/16"		380
		06-07	CILINDRO DE RUEDA	370180	IZQ	15/16"		380
		02-04	CILINDRO DE RUEDA	370181	DER	26.9 mm 1-1/16"		380
		06-07	CILINDRO DE RUEDA	370181	DER	26.9 mm 1-1/16"		380
		08-14	CILINDRO DE RUEDA	370200	IZQ	1 1/16"		381
		08-14	CILINDRO DE RUEDA	370201	DER	15/16"		381
		92-94	CILINDRO MAESTRO	39646		28.6mm & 40mm		294
		95-00	CILINDRO MAESTRO	390257		1-1/4"	HYDROBOOSTER	306
		94-00	CILINDRO MAESTRO	390259		40mm & 1/8"	FABRICACION NACIONAL	306
		02-04	CILINDRO MAESTRO	390541		34mm		317
		02-04	CILINDRO MAESTRO	390542		37mm		318
		06-07	CILINDRO MAESTRO	390542		37mm		318
		06-14	CILINDRO MAESTRO	391169		1-1/8"		346
		08-14	CILINDRO MAESTRO	391172		1-1/4"		346
	92-00	MANGUERA DE FRENOS	38620	DEL IZQ	25.13"		394	
	92-00	MANGUERA DE FRENOS	38621	DEL DER	25.13"		394	
	92-00	MANGUERA DE FRENOS	38624	TRAS DER	17.75"		394	





Modelo	Versión	Año	Descripción	Número Lusac	Posición	Diámetro	Notas	Foto Pág.
CHEVROLET								
CHEYENNE		92-00	MANGUERA DE FRENOS	38624	TRAS IZQ	17.75"		394
		92-00	PISTÓN FRENO DE DISCO	85157	DEL	74.6 mm 2-15/16"		520
		92-94	REP. CIL. MAESTRO Y DE CLUTCH	1737		28.5 mm 1-1/8"		557
		95-00	REP. CIL. MAESTRO Y DE CLUTCH	39650		31.7 mm 1-1/4"		557
		94-00	REP. CIL. MAESTRO Y DE CLUTCH	104459		28.5 mm 1-1/8"		560
		92-00	REPUESTO FRENO DE DISCO	2005	DEL	74.6 mm 2-15/16"		538
CITATION		82-86	MANGUERA DE FRENOS	2025	TRAS DER	8"		385
		82-86	MANGUERA DE FRENOS	2025	TRAS IZQ	8"		385
		82-86	MANGUERA DE FRENOS	4051	DEL IZQ	16 1/16"		386
		82-86	MANGUERA DE FRENOS	4068	DEL DER	17 5/8"		386
		82-86	PISTÓN FRENO DE DISCO	100799	DEL	57.1 mm 2-1/4"		528
		82-86	REPUESTO FRENO DE DISCO	100797	DEL	57.1 mm 2-1/4"		553
		85-91	CILINDRO DE CLUTCH	360002	INF	31.7 mm 1-1/4"		
		82-86	CILINDRO DE RUEDA	104384	DER	17.4 mm 11/16"		372
		82-86	CILINDRO DE RUEDA	104384	IZQ	17.4 mm 11/16"		372
		82-86	CILINDRO MAESTRO	116403		22.2 mm 7/8"		298
	82-86	REP. CIL. MAESTRO Y DE CLUTCH	99984		22.2 mm 7/8"		560	
COBALT		08-08	CILINDRO DE CLUTCH	360111		N.R.		
		05-08	CILINDRO DE RUEDA	370186	TRAS IZQ DER	13/16"		380
		08-08	CILINDRO MAESTRO	390981		7/8"	NATURALMENTE ASPIRADO TRANSEJE MANUAL; S/C FRENOS ACTIVO	337
		05-07	CILINDRO MAESTRO	390981		7/8"	TRANSEJE MANUAL	337
		08-08	CILINDRO MAESTRO	390985		7/8"	NATURALMENTE ASPIRADO TRANSEJE AUTOMÁTICO; S/C FRENOS ACTIVO	338
		05-07	CILINDRO MAESTRO	390985		7/8"	TRANSEJE AUTOMÁTICO	338
COLORADO		04-12	MANGUERA DE FRENOS	382602	DEL DER	16.5"		476
		04-12	MANGUERA DE FRENOS	382603	DEL DER	20.88"		476
		04-12	MANGUERA DE FRENOS	382606	DEL IZQ	16.25"		476
		04-12	MANGUERA DE FRENOS	382677	TRAS IZQ	16"		481
		04-08	PISTÓN FRENO DE DISCO	851052	N/D	N/D		533
		04-08	REPUESTO FRENO DE DISCO	21052	DEL	45.5 mm		549
		04-12	CILINDRO DE RUEDA	370148	DER	15/16"		378
		04-12	CILINDRO DE RUEDA	370148	IZQ	15/16"		378
		09-12	CILINDRO DE RUEDA	370201	DER	15/16"		381
		09-12	CILINDRO DE RUEDA	370201	IZQ	15/16"		381
	04-08	CILINDRO MAESTRO	390845		1"	4X2	331	
	04-08	CILINDRO MAESTRO	390845		1"	4X4	331	
CORSA		02-08	PISTÓN FRENO DE DISCO	85390	DEL	48.0 mm 1-57/64"		523
		02-08	REPUESTO FRENO DE DISCO	2390	DEL	48.0 mm 1-57/64"		541
	SEDAN	03-08	CILINDRO DE RUEDA	834	DER	19.0 mm 3/4"		364
	SEDAN	03-08	CILINDRO DE RUEDA	834	IZQ	19.0 mm 3/4"		364
	SEDAN	03-05	CILINDRO MAESTRO	3495064		22.2 mm 7/8"		358

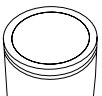

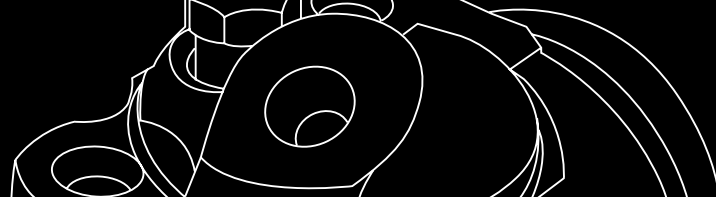

Modelo	Versión	Año	Descripción	Número Lusac	Posición	Diámetro	Notas	Foto Pág.
CHEVROLET								
CORSA	SEDAN	03-08	CILINDRO MAESTRO	39009907		7/8"	1.8 LTS	361
	SEDAN	03-08	PISTÓN FRENO DE DISCO	85390	DEL	48.0 mm 1-57/64"		523
	SEDAN	03-08	REPUESTO FRENO DE DISCO	2390	DEL	48.0 mm 1-57/64"		541
			CILINDRO DE RUEDA	834	DER	19.0 mm 3/4"		364
		02-08	CILINDRO DE RUEDA	834	IZQ	19.0 mm 3/4"		364
		02-05	CILINDRO MAESTRO	3495064		22.2 mm 7/8"		358
		06-08	CILINDRO MAESTRO	39009907		7/8"	1.8 LTS	361
CORVETTE	91-92	MANGUERA DE FRENOS	38614	DEL IZQ	12.88"		393	
	91-92	MANGUERA DE FRENOS	38656	TRAS DER	11.88"		395	
	93-93	MANGUERA DE FRENOS	380192	DEL DER	12"		408	
	93-93	MANGUERA DE FRENOS	380192	DEL IZQ	12"		408	
	94-96	MANGUERA DE FRENOS	380259	DEL IZQ	15.5"		410	
	94-96	MANGUERA DE FRENOS	380260	DEL DER	15.5"		410	
	97-04	MANGUERA DE FRENOS	382405	DEL DER	15.38"		464	
	97-04	MANGUERA DE FRENOS	382405	DEL IZQ	15.38"		464	
	05-13	MANGUERA DE FRENOS	382632	DEL DER	18.5"		478	
05-13	MANGUERA DE FRENOS	382692	DEL IZQ	18"		482		
05-13	MANGUERA DE FRENOS	382693	DEL DER	18"		482		
CRUZE	10-14	CILINDRO DE RUEDA	370226	DER	13/16"		382	
	10-14	CILINDRO DE RUEDA	370226	IZQ	13/16"		382	
	10-14	CILINDRO MAESTRO	391154		1"		345	
EQUINOX	07-08	MANGUERA DE FRENOS	382700	DEL IZQ	18.81"		483	
	07-08	MANGUERA DE FRENOS	382701	DEL DER	18.81"		483	
	05-06	MANGUERA DE FRENOS	382742	DEL IZQ	19"		486	
	05-08	PISTÓN FRENO DE DISCO	85857	DEL	46.0 mm 1-13/16"		527	
	05-08	REPUESTO FRENO DE DISCO	2857	DEL	46.0 mm 1-13/16"		544	
	05-06	CILINDRO DE RUEDA	370130	DER	7/8"		377	
	05-06	CILINDRO DE RUEDA	370130	IZQ	7/8"		377	
	05-06	CILINDRO MAESTRO	390739		1"		325	
07-08	CILINDRO MAESTRO	391145		1"		344		
	05-08	KIT DE PISTÓN Y REPUESTO FD	742380	DEL	46.0 mm 1-13/16"	CON CALIPER DE DOBLE PISTON		
EXPRESS	1500	96-96	CILINDRO DE RUEDA	37985	TRAS IZQ DER	15/16"		369
	1500	96-96	CILINDRO MAESTRO	390363		1-1/8"		310
	1500	14-14	CILINDRO MAESTRO	391252		1-5/16"		352
	1500	96-96	MANGUERA DE FRENOS	38624	CTR	17.75"		394
	1500	96-96	MANGUERA DE FRENOS	380752	IZQ	22.75"		427
	1500	96-96	MANGUERA DE FRENOS	380753	DER	22.75"		427
	1500 CAR-GO VAN	03-08	CILINDRO MAESTRO	390843		34mm		331
	1500 CAR-GO VAN	07-08	CILINDRO MAESTRO	391179		34mm	S/C DE FRENO ACTIVO	347
	1500 CAR-GO VAN	09-13	CILINDRO MAESTRO	391252		1-5/16"	C/C DE FRENO ACTIVO	352
	1500 CAR-GO VAN	09-13	CILINDRO MAESTRO	391253		1-5/16"	S/C DE FRENO ACTIVO	352
	1500 CAR-GO VAN	07-13	PISTÓN FRENO DE DISCO	2160	TRAS	50.8 mm 2"	CALIPER DOBLE PISTON	517
	1500 CAR-GO VAN	03-06	PISTÓN FRENO DE DISCO	85157	DEL	74.6 mm 2-15/16"	CALIPER DOBLE PISTON	520
1500 CAR-GO VAN	07-13	PISTÓN FRENO DE DISCO	851110	TRAS	44.4 mm 1-3/4"	CALIPER DOBLE PISTON	534	





Modelo	Versión	Año	Descripción	Número Lusac	Posición	Diámetro	Notas	Foto Pág.
CHEVROLET								
EXPRESS	1500 CAR-GO VAN	03-08	REP. CIL. MAESTRO Y DE CLUTCH	904090		34.0mm		563
	1500 CAR-GO VAN	03-06	REPUESTO FRENO DE DISCO	2005	DEL	74.6 mm 2-15/16"	CALIPER DOBLE PISTON	538
	1500 CAR-GO VAN	07-13	REPUESTO FRENO DE DISCO	2111	TRAS	44.4 mm 1-3/4"	CALIPER DOBLE PISTON	
	1500 CAR-GO VAN	07-13	REPUESTO FRENO DE DISCO	2159	TRAS	50.8 mm 2"	CALIPER DOBLE PISTON	540
	2500	96-96	CILINDRO DE RUEDA	37985	TRAS IZQ DER	15/16"		369
	2500	96-96	CILINDRO DE RUEDA	79767	TRAS IZQ DER	26.9 mm 1-1/16"		371
	2500	96-96	CILINDRO DE RUEDA	116359	TRAS IZQ DER	25.4 mm 1"	DIESEL	373
	2500	96-96	CILINDRO MAESTRO	390363		1-1/8"	C/BOOSTER DE VACÍO	310
	2500	96-96	CILINDRO MAESTRO	390364		1-1/4"	HYDROBOOSTER	310
	2500	14-14	CILINDRO MAESTRO	391184		1-1/2"	C/C FRENOS ACTIVO	347
	2500	96-96	MANGUERA DE FRENOS	38624	CTR	17.75"		394
	2500	96-96	MANGUERA DE FRENOS	380587	DER	21.33"	HYDROBOOSTER	426
	2500	96-96	MANGUERA DE FRENOS	380588	IZQ	21.33"	HYDROBOOSTER	426
	2500	96-96	MANGUERA DE FRENOS	380752	IZQ	22.75"	C/BOOSTER DE VACÍO	427
	2500	96-96	MANGUERA DE FRENOS	380753	DER	22.75"	C/BOOSTER DE VACÍO	427
	2500 EXT	96-96	CILINDRO DE RUEDA	37985	TRAS IZQ DER	15/16"		369
	2500 EXT	96-96	CILINDRO DE RUEDA	79767	TRAS IZQ DER	26.9 mm 1-1/16"		371
	2500 EXT	96-96	CILINDRO DE RUEDA	116359	TRAS IZQ DER	25.4 mm 1"	DIESEL	373
	2500 EXT	96-96	CILINDRO MAESTRO	390363		1-1/8"	C/BOOSTER DE VACÍO	310
	2500 EXT	96-96	CILINDRO MAESTRO	390364		1-1/4"	HYDROBOOSTER	310
	2500 EXT	14-14	CILINDRO MAESTRO	391184		1-1/2"	C/C FRENOS ACTIVO	347
	2500 EXT	96-96	MANGUERA DE FRENOS	38624	CTR	17.75"		394
	2500 EXT	96-96	MANGUERA DE FRENOS	380587	DER	21.33"	HYDROBOOSTER	426
	2500 EXT	96-96	MANGUERA DE FRENOS	380588	IZQ	21.33"	HYDROBOOSTER	426
	2500 EXT	96-96	MANGUERA DE FRENOS	380752	IZQ	22.75"	C/BOOSTER DE VACÍO	427
	2500 EXT	96-96	MANGUERA DE FRENOS	380753	DER	22.75"	C/BOOSTER DE VACÍO	427
	3500	96-96	CILINDRO DE RUEDA	079768	TRAS IZQ DER	30.1 mm 1-3/16"	DOBLE RODADA	371
	3500	96-96	CILINDRO DE RUEDA	116359	TRAS IZQ DER	25.4 mm 1"	RODADA SENCILLA	373
	3500	96-96	CILINDRO MAESTRO	390364		1-1/4"		310
	3500	14-14	CILINDRO MAESTRO	391184		1-1/2"	C/C FRENOS ACTIVO	347
	3500	96-96	MANGUERA DE FRENOS	38624	CTR	17.75"		394
	3500	96-96	MANGUERA DE FRENOS	380587	DER	21.33"	RODADA SENCILLA	426
	3500	96-96	MANGUERA DE FRENOS	380588	IZQ	21.33"	RODADA SENCILLA	426
	3500	96-96	MANGUERA DE FRENOS	382319	IZQ	25"	DOBLE RODADA	456
	3500	96-96	MANGUERA DE FRENOS	382320	DER	24.75"	DOBLE RODADA	456
	3500 EXT	96-96	CILINDRO DE RUEDA	079768	TRAS IZQ DER	30.1 mm 1-3/16"	DOBLE RODADA	371
	3500 EXT	96-96	CILINDRO DE RUEDA	116359	TRAS IZQ DER	25.4 mm 1"	RODADA SENCILLA	373
	3500 EXT	14-14	CILINDRO MAESTRO	391184		1-1/2"	C/C FRENOS ACTIVO	347
	3500 EXT	96-96	MANGUERA DE FRENOS	38624	CTR	17.75"		394
	3500 EXT	96-96	MANGUERA DE FRENOS	380587	DER	21.33"	RODADA SENCILLA	426
	3500 EXT	96-96	MANGUERA DE FRENOS	380588	IZQ	21.33"	RODADA SENCILLA	426



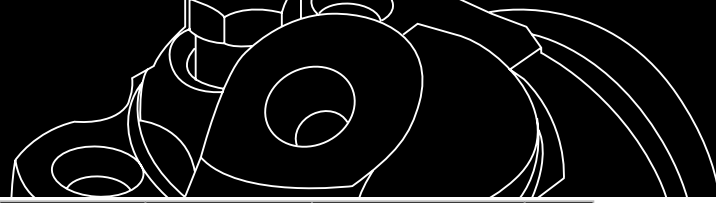

Modelo	Versión	Año	Descripción	Número Lusac	Posición	Diámetro	Notas	Foto Pág.
EXPRESS	3500 EXT	96-96	MANGUERA DE FRENOS	382319	IZQ	25"	DOBLE RODADA	456
	3500 EXT	96-96	MANGUERA DE FRENOS	382320	DER	24.75"	DOBLE RODADA	456
	CARGO VAN 2500	04-06	CILINDRO DE RUEDA	37985	DER	15/16"		369
	CARGO VAN 2500	04-06	CILINDRO DE RUEDA	37985	IZQ	15/16"		369
	CARGO VAN 2500	04-08	CILINDRO MAESTRO	390818		37mm		330
	CARGO VAN 2500	04-06	CILINDRO MAESTRO	390843		34mm		331
	CARGO VAN 2500	09-13	CILINDRO MAESTRO	391184		1-1/2"		347
	CARGO VAN 2500	04-06	MANGUERA DE FRENOS	38624	DEL DER	17.75"		394
	CARGO VAN 2500	04-06	MANGUERA DE FRENOS	38624	DEL IZQ	17.75"		394
	CARGO VAN 2500	04-06	MANGUERA DE FRENOS	38624	TRAS DER	17.75"		394
	CARGO VAN 2500	04-06	MANGUERA DE FRENOS	38624	TRAS IZQ	17.75"		394
	CARGO VAN 2500	04-06	PISTÓN FRENO DE DISCO	85157	DEL	74.6 mm 2-15/16"	CALIPER DOBLE PISTON	520
	CARGO VAN 2500	07-13	PISTÓN FRENO DE DISCO	851010	TRAS	50.8 mm 2"	CALIPER DOBLE PISTON	530
	CARGO VAN 2500	07-13	PISTÓN FRENO DE DISCO	851070	DEL	57.1 mm 2-1/4"	CALIPER DOBLE PISTON	533
	CARGO VAN 2500	04-06	PISTÓN FRENO DE DISCO	851110	TRAS	44.4 mm 1-3/4"	CALIPER DOBLE PISTON	534
	CARGO VAN 2500	07-08	REP. CIL. MAESTRO Y DE CLUTCH	904090		34.0mm		563
	CARGO VAN 2500	11-13	REP. CIL. MAESTRO Y DE CLUTCH	904090		34.0mm		563
	CARGO VAN 2500	04-06	REPUESTO FRENO DE DISCO	2005	DEL	74.6 mm 2-15/16"	CALIPER DOBLE PISTON	538
	CARGO VAN 2500	07-13	REPUESTO FRENO DE DISCO	2107	DEL	57.1 mm 2-1/4"	CALIPER DOBLE PISTON	539
	CARGO VAN 2500	04-06	REPUESTO FRENO DE DISCO	2111	TRAS	44.4 mm 1-3/4"	CALIPER DOBLE PISTON	
	CARGO VAN 2500	07-13	REPUESTO FRENO DE DISCO	21010	TRAS	50.8 mm 2"	CALIPER DOBLE PISTON	546
	CARGO VAN G-15	98-02	CILINDRO DE RUEDA	37985	DER	15/16"		369
	CARGO VAN G-15	98-02	CILINDRO DE RUEDA	37985	IZQ	15/16"		369
	CARGO VAN G-15	98-02	CILINDRO MAESTRO	390363		1-1/8"		310
	CARGO VAN G-15	98-02	MANGUERA DE FRENOS	38624	TRAS IZQ	17.75"		394
	CARGO VAN G-15	98-02	MANGUERA DE FRENOS	380752	DEL IZQ	22.75"		427
	CARGO VAN G-15	98-02	MANGUERA DE FRENOS	380753	DEL DER	22.75"		427
	CARGO VAN G-15	98-05	PISTÓN FRENO DE DISCO	85157	DEL	74.6 mm 2-15/16"	CALIPER DOBLE PISTON	520
	CARGO VAN G-15	98-05	REPUESTO FRENO DE DISCO	2005	DEL	74.6 mm 2-15/16"	CALIPER DOBLE PISTON	538
	CARGO VAN G-20	95-95	CILINDRO DE RUEDA	51081	DER	23.8 mm 15/16"		370
	CARGO VAN G-20	95-95	CILINDRO DE RUEDA	51081	IZQ	23.8 mm 15/16"		370
	CARGO VAN G-20	95-95	CILINDRO MAESTRO	39308		30mm	HYDROBOOSTER	294
	CARGO VAN G-20	95-95	MANGUERA DE FRENOS	38068	TRAS IZQ	18.25"		388





Modelo	Versión	Año	Descripción	Número Lusac	Posición	Diámetro	Notas	Foto Pág.
CHEVROLET								
EXPRESS	CARGO VAN G-20	95-95	MANGUERA DE FRENOS	38182	DEL IZQ	23.94"		389
	CARGO VAN G-20	95-95	MANGUERA DE FRENOS	38183	DEL DER	23.19"		389
	CARGO VAN G-20	95-95	PISTÓN FRENO DE DISCO	76008	DEL	74.6 mm 2-15/16"		518
	CARGO VAN G-20	95-95	REPUESTO FRENO DE DISCO	59176	DEL	74.6 mm 2-15/16"		552
	CARGO VAN G-30	97-97	CILINDRO DE RUEDA	79767	DER	26.9 mm 1-1/16"		371
	CARGO VAN G-30	01-02	CILINDRO DE RUEDA	79767	DER	26.9 mm 1-1/16"		371
	CARGO VAN G-30	97-97	CILINDRO DE RUEDA	79767	IZQ	26.9 mm 1-1/16"		371
	CARGO VAN G-30	01-02	CILINDRO DE RUEDA	79767	IZQ	26.9 mm 1-1/16"		371
	CARGO VAN G-30	98-00	CILINDRO DE RUEDA	116359	DER	25.4 mm 1"		373
	CARGO VAN G-30	98-00	CILINDRO DE RUEDA	116359	IZQ	25.4 mm 1"		373
	CARGO VAN G-30	97-02	CILINDRO MAESTRO	390364		1-1/4"		310
	CARGO VAN G-30	97-02	MANGUERA DE FRENOS	38624	TRAS IZQ	17.75"		394
	CARGO VAN G-30	97-02	MANGUERA DE FRENOS	380587	DEL DER	21.33"		426
	CARGO VAN G-30	97-02	MANGUERA DE FRENOS	380588	DEL IZQ	21.33"		426
	CARGO VAN G-30	97-02	PISTÓN FRENO DE DISCO	85156	DEL	80.2 mm 3-5/32"		520
	CARGO VAN G-30	03-05	PISTÓN FRENO DE DISCO	851070	DEL	57.1 mm 2-1/4"	CALIPER DOBLE PISTON	533
	CARGO VAN G-30	03-05	REPUESTO FRENO DE DISCO	2107	DEL	57.1 mm 2-1/4"	CALIPER DOBLE PISTON	539
	CARGO VAN G-30	97-02	REPUESTO FRENO DE DISCO	2110	DEL	80.2 mm 3-5/32"		539
	CUTAWAY	11-12	CILINDRO MAESTRO	391184		1-1/2"	C/C DE FRENO ACTIVO	347
	VAN	07-08	CILINDRO MAESTRO	390818		37mm	V8	330
	VAN	07-12	CILINDRO MAESTRO	391026		37mm	V8	340
	VAN	07-10	CILINDRO MAESTRO	391082		37mm	S/C DE FRENO ACTIVO V8	342
	VAN	09-12	CILINDRO MAESTRO	391184		1-1/2"	C/C DE FRENO ACTIVO V8	347
	VAN	07-10	PISTÓN FRENO DE DISCO	851070	DEL	57.1 mm 2-1/4"	CALIPER DOBLE PISTON V8	533
	VAN	07-10	PISTÓN FRENO DE DISCO	851110	TRAS	44.4 mm 1-3/4"	CALIPER DOBLE PISTON V8	534
	VAN	07-10	REPUESTO FRENO DE DISCO	2107	DEL	57.1 mm 2-1/4"	CALIPER DOBLE PISTON V8	539
	VAN	07-10	REPUESTO FRENO DE DISCO	2111	TRAS	44.4 mm 1-3/4"	CALIPER DOBLE PISTON V8	
	VAN 1500	98-02	CILINDRO DE RUEDA	37985	DER	15/16"		369
	VAN 1500	98-02	CILINDRO DE RUEDA	37985	IZQ	15/16"		369
	VAN 1500	98-02	CILINDRO MAESTRO	390363		1-1/8"		310
	VAN 1500	98-02	MANGUERA DE FRENOS	38624	TRAS DER	17.75"		394
	VAN 1500	98-02	MANGUERA DE FRENOS	38624	TRAS IZQ	17.75"		394
	VAN 1500	98-02	MANGUERA DE FRENOS	380752	DEL IZQ	22.75"		427
VAN 1500	98-02	MANGUERA DE FRENOS	380753	DEL DER	22.75"		427	
VAN 1500	98-02	PISTÓN FRENO DE DISCO	85157	DEL	74.6 mm 2-15/16"		520	

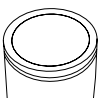



Modelo	Versión	Año	Descripción	Número Lusac	Posición	Diámetro	Notas	Foto Pág.
EXPRESS	VAN 1500	98-02	REPUESTO FRENO DE DISCO	2005	DEL	74.6 mm 2-15/16"		538
	VAN 2500	98-99	CILINDRO DE RUEDA	37985	DER	15/16"		369
	VAN 2500	98-99	CILINDRO DE RUEDA	37985	IZQ	15/16"		369
	VAN 2500	98-99	CILINDRO MAESTRO	390363		1-1/8"		310
	VAN 2500	98-99	MANGUERA DE FRENOS	38624	TRAS DER	17.75"		394
	VAN 2500	98-99	MANGUERA DE FRENOS	38624	TRAS IZQ	17.75"		394
	VAN 2500	98-99	MANGUERA DE FRENOS	380752	DEL IZQ	22.75"		427
	VAN 2500	98-99	MANGUERA DE FRENOS	380753	DEL DER	22.75"		427
	VAN 2500	98-99	PISTÓN FRENO DE DISCO	85157	DEL	74.6 mm 2-15/16"		520
	VAN 2500	98-99	REPUESTO FRENO DE DISCO	2005	DEL	74.6 mm 2-15/16"		538
	VAN 3500	99-02	CILINDRO DE RUEDA	79767	DER	26.9 mm 1-1/16"		371
	VAN 3500	99-02	CILINDRO DE RUEDA	79767	IZQ	26.9 mm 1-1/16"		371
	VAN 3500	99-00	CILINDRO DE RUEDA	116359	DER	25.4 mm 1"		373
	VAN 3500	99-00	CILINDRO DE RUEDA	116359	IZQ	25.4 mm 1"		373
	VAN 3500	99-02	CILINDRO MAESTRO	390364		1-1/4"		310
	VAN 3500	99-02	MANGUERA DE FRENOS	38624	TRAS DER	17.75"		394
	VAN 3500	99-02	MANGUERA DE FRENOS	38624	TRAS IZQ	17.75"		394
	VAN 3500	99-02	MANGUERA DE FRENOS	380587	DEL DER	21.33"		426
	VAN 3500	99-02	MANGUERA DE FRENOS	380588	DEL IZQ	21.33"		426
	VAN 3500	99-02	MANGUERA DE FRENOS	382319	DEL IZQ	25"		456
	VAN 3500	99-02	MANGUERA DE FRENOS	382320	DEL DER	24.75"		456
	VAN 3500	99-02	PISTÓN FRENO DE DISCO	85156	DEL	80.2 mm 3-5/32"		520
	VAN 3500	01-02	PISTÓN FRENO DE DISCO	851070	DEL	57.1 mm 2-1/4"		533
	VAN 3500	01-02	REPUESTO FRENO DE DISCO	2107	DEL	57.1 mm 2-1/4"		539
	VAN 3500	99-02	REPUESTO FRENO DE DISCO	2110	DEL	80.2 mm 3-5/32"		539
	VAN 3500	03-06	CILINDRO MAESTRO	390364		1-1/4"		310
	VAN 3500	03-08	CILINDRO MAESTRO	390818		37mm		330
	VAN 3500	03-08	CILINDRO MAESTRO	391026		37mm		340
	VAN 3500	11-13	CILINDRO MAESTRO	391026		37mm		340
	VAN 3500	07-08	CILINDRO MAESTRO	391082		37mm	S/C DE FRENO ACTIVO	342
	VAN 3500	11-13	CILINDRO MAESTRO	391184		1-1/2"	C/C DE FRENO ACTIVO	347
	VAN 3500	03-06	MANGUERA DE FRENOS	380587	DEL DER	21.33"		426
	VAN 3500	03-06	MANGUERA DE FRENOS	380588	DEL IZQ	21.33"		426
	VAN 3500	03-06	MANGUERA DE FRENOS	382319	DEL IZQ	25"		456
	VAN 3500	03-06	MANGUERA DE FRENOS	382320	DEL DER	24.75"		456
	VAN 3500	03-08	PISTÓN FRENO DE DISCO	851010	TRAS	50.8 mm 2"		530
	VAN 3500	11-13	PISTÓN FRENO DE DISCO	851010	TRAS	50.8 mm 2"		530
	VAN 3500	03-08	PISTÓN FRENO DE DISCO	851070	DEL	57.1 mm 2-1/4"	CALIPER DOBLE PISTON	533
	VAN 3500	11-13	PISTÓN FRENO DE DISCO	851070	DEL	57.1 mm 2-1/4"	CALIPER DOBLE PISTON	533
	VAN 3500	03-08	PISTÓN FRENO DE DISCO	851110	TRAS	44.4 mm 1-3/4"	CALIPER DOBLE PISTON	534
	VAN 3500	11-13	PISTÓN FRENO DE DISCO	851110	TRAS	44.4 mm 1-3/4"	CALIPER DOBLE PISTON	534
	VAN 3500	03-08	REPUESTO FRENO DE DISCO	2107	DEL	57.1 mm 2-1/4"	CALIPER DOBLE PISTON	539
	VAN 3500	11-13	REPUESTO FRENO DE DISCO	2107	DEL	57.1 mm 2-1/4"	CALIPER DOBLE PISTON	539

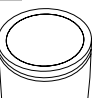



Modelo	Versión	Año	Descripción	Número Lusac	Posición	Diámetro	Notas	Foto Pág.
CHEVROLET								
EXPRESS	VAN 3500	03-08	REPUESTO FRENO DE DISCO	2111	TRAS	44.4 mm 1-3/4"	CALIPER DOBLE PISTON	
	VAN 3500	11-13	REPUESTO FRENO DE DISCO	2111	TRAS	44.4 mm 1-3/4"	CALIPER DOBLE PISTON	
	VAN 3500	03-08	REPUESTO FRENO DE DISCO	21010	TRAS	50.8 mm 2"		546
	VAN 3500	11-13	REPUESTO FRENO DE DISCO	21010	TRAS	50.8 mm 2"		546
	VAN 3500	09-10	CILINDRO MAESTRO	391026		37mm		340
	VAN 3500	09-10	CILINDRO MAESTRO	391082		37mm	S/C DE FRENO ACTIVO	342
	VAN 3500	09-10	CILINDRO MAESTRO	391184		1-1/2"	C/C DE FRENO ACTIVO	347
	VAN 3500	09-10	PISTÓN FRENO DE DISCO	851010	TRAS	50.8 mm 2"		530
	VAN 3500	09-10	PISTÓN FRENO DE DISCO	851070	DEL	57.1 mm 2-1/4"	CALIPER DOBLE PISTON	533
	VAN 3500	09-10	PISTÓN FRENO DE DISCO	851110	TRAS	44.4 mm 1-3/4"	CALIPER DOBLE PISTON	534
	VAN 3500	09-10	REPUESTO FRENO DE DISCO	2107	DEL	57.1 mm 2-1/4"	CALIPER DOBLE PISTON	539
	VAN 3500	09-10	REPUESTO FRENO DE DISCO	2111	TRAS	44.4 mm 1-3/4"	CALIPER DOBLE PISTON	
	VAN 3500	09-10	REPUESTO FRENO DE DISCO	21010	TRAS	50.8 mm 2"		546
	1500	07-14	KIT DE PISTÓN Y REPUESTO FD	742344	DEL	50.8 mm 2"	CON 6 BIRLOS	
	1500	98-06	KIT DE PISTÓN Y REPUESTO FD	742351	DEL	74.6 mm 2-15/16"	CON CALIPER DE DOBLE PISTON	
	1500	07-14	KIT DE PISTÓN Y REPUESTO FD	742385	TRAS	44.4 mm 1-3/4"	CON 6 BIRLOS	
	2500	09-13	CILINDRO MAESTRO	391168		38.1 mm 1-1/2"	S/C ACTIVO DE FRENOS	
	2500	07-08	CILINDRO MAESTRO	391180		37.0 mm	C/C ACTIVO DE FRENOS	
	2500	98-06	KIT DE PISTÓN Y REPUESTO FD	742351	DEL	74.6 mm 2-15/16"	CON CALIPER DE DOBLE PISTON	
	2500	02-06	KIT DE PISTÓN Y REPUESTO FD	742385	TRAS	44.4 mm 1-3/4"		
	3500	11-13	CILINDRO MAESTRO	391168		38.1 mm 1-1/2"	S/C ACTIVO DE FRENOS 8 PASAJEROS	
	3500	07-08	CILINDRO MAESTRO	391180		37.0 mm	C/C ACTIVO DE FRENOS 8 PASAJEROS	
	3500	91-93	KIT DE PISTÓN Y REPUESTO FD	742351	DEL	74.6 mm 2-15/16"		
	3500	02-14	KIT DE PISTÓN Y REPUESTO FD	742385	TRAS	44.4 mm 1-3/4"	CALIPER DE DOBLE PISTON	
CUTAWAY	11-12	CILINDRO MAESTRO	391168		38.1 mm 1-1/2"	S/C ACTIVO DE FRENOS		
G3		09-10	CILINDRO MAESTRO	391333		7/8"	S/ABS TRANSMISIÓN ESTÁNDARDD	356
G-30 EXPRESS		97-02	MANGUERA DE FRENOS	38624	TRAS DER	17.75"		394
		97-02	MANGUERA DE FRENOS	38624	TRAS IZQ	17.75"		394
		97-03	MANGUERA DE FRENOS	380587	DEL DER	21.33"		426
		97-03	MANGUERA DE FRENOS	380588	DEL IZQ	21.33"		426
		97-03	MANGUERA DE FRENOS	382319	DEL IZQ	25"		456
		97-03	MANGUERA DE FRENOS	382320	DEL DER	24.75"		456
		97-02	PISTÓN FRENO DE DISCO	85156	DEL	80.2 mm 3-5/32"		520
		03-03	PISTÓN FRENO DE DISCO	851010	TRAS	50.8 mm 2"		530

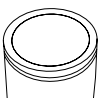



Modelo	Versión	Año	Descripción	Número Lusac	Posición	Diámetro	Notas	Foto Pág.
G-30 EXPRESS		01-03	PISTÓN FRENO DE DISCO	851070	DEL	57.1 mm 2-1/4"	CALIPER DOBLE PISTON	533
		03-03	PISTÓN FRENO DE DISCO	851110	TRAS	44.4 mm 1-3/4"	CALIPER DOBLE PISTON	534
		01-03	REPUESTO FRENO DE DISCO	2107	DEL	57.1 mm 2-1/4"	CALIPER DOBLE PISTON	539
		97-02	REPUESTO FRENO DE DISCO	2110	DEL	80.2 mm 3-5/32"		539
		03-03	REPUESTO FRENO DE DISCO	2111	TRAS	44.4 mm 1-3/4"	CALIPER DOBLE PISTON	
		03-03	REPUESTO FRENO DE DISCO	21010	TRAS	50.8 mm 2"		546
		97-02	CILINDRO DE RUEDA	79767	DER	26.9 mm 1-1/16"		371
		97-02	CILINDRO DE RUEDA	79767	IZQ	26.9 mm 1-1/16"		371
		97-00	CILINDRO DE RUEDA	116359	DER	25.4 mm 1"		373
		97-00	CILINDRO DE RUEDA	116359	IZQ	25.4 mm 1"		373
		97-03	CILINDRO MAESTRO	390364		1-1/4"		310
		03-03	CILINDRO MAESTRO	391026		37mm		340
HHR		06-09	MANGUERA DE FRENOS	381634	TRAS IZQ	9.7"		451
		06-09	PISTÓN FRENO DE DISCO	851051	N/D	N/D		533
		06-09	REPUESTO FRENO DE DISCO	642	DEL	60.3 mm 2-3/8"		536
		08-08	CILINDRO DE CLUTCH	360111		N.R.		
		06-09	CILINDRO DE RUEDA	370186	DER	13/16"		380
		06-09	CILINDRO DE RUEDA	370186	IZQ	13/16"		380
		06-11	CILINDRO MAESTRO	391165		15/16"	TRANSEJE AUTOMÁTICO	345
		06-08	CILINDRO MAESTRO	391328		15/16"	ESTÁNDAR	355
		06-09	CILINDRO MAESTRO	391329		15/16"		355
		08-11	CILINDRO MAESTRO	391358		15/16"		356
IMPALA		00-04	MANGUERA DE FRENOS	380581	DEL DER	15.5"		426
		00-04	MANGUERA DE FRENOS	380581	DEL IZQ	15.5"		426
		00-04	MANGUERA DE FRENOS	381271	TRAS DER	10.88"		439
		00-04	MANGUERA DE FRENOS	381271	TRAS IZQ	10.88"		439
		00-04	PISTÓN FRENO DE DISCO	85088	DEL	63.5 mm 2-1/2"		519
		00-04	PISTÓN FRENO DE DISCO	85476	TRAS	38.1 mm 1-1/2"		525
		00-04	REPUESTO FRENO DE DISCO	1759	TRAS	38.1 mm 1-1/2"		
		00-04	REPUESTO FRENO DE DISCO	2476	TRAS	38.1 mm 1-1/2"		
		00-04	REPUESTO FRENO DE DISCO	99024	DEL	63.5 mm 2-1/2"		553
		00-04	CILINDRO MAESTRO	390401		1"	C/ABS	312
		00-04	CILINDRO MAESTRO	390645		1"	S/ABS	321
		00-04	KIT DE PISTÓN Y REPUESTO FD	742396	TRAS	38.1 mm 1-1/2"	C/ABS	
	00-04	KIT DE PISTÓN Y REPUESTO FD	742396	TRAS	38.1 mm 1-1/2"	S/ABS		
K10		88-91	CILINDRO DE CLUTCH	37815		20.6 mm 13/16"		
		94-95	CILINDRO DE CLUTCH	350182		18.0 mm	CHOCOLATE	
K15		88-91	CILINDRO DE CLUTCH	37815		20.6 mm 13/16"		
		94-95	CILINDRO DE CLUTCH	350182		18.0 mm	CHOCOLATE	
K20		88-91	CILINDRO DE CLUTCH	37815		20.6 mm 13/16"		
		88-95	MANGUERA DE FRENOS	38622	DEL IZQ	25.75"	CHOCOLATE	394
K25		88-91	CILINDRO DE CLUTCH	37815		20.6 mm 13/16"		
		88-95	MANGUERA DE FRENOS	38622	DEL IZQ	25.75"	CHOCOLATE	394





Modelo	Versión	Año	Descripción	Número Lusac	Posición	Diámetro	Notas	Foto Pág.	
CHEVROLET									
K30		88-91	CILINDRO DE CLUTCH	37815		20.6 mm 13/16"			
K35		88-91	CILINDRO DE CLUTCH	37815		20.6 mm 13/16"			
KODIAK		97-03	PISTÓN FRENO DE DISCO	85081	DEL Y TRAS	63.5 mm 2-1/2"			
		96-98	REPUESTO FRENO DE DISCO	2080	DEL Y TRAS	73.0 mm 2-7/8"			
LUMINA	APV	95-96	CILINDRO DE RUEDA	37855	DER	23.8 mm 15/16"		367	
	APV	95-96	CILINDRO DE RUEDA	37855	IZQ	23.8 mm 15/16"		367	
	APV	95-96	CILINDRO MAESTRO	390178		24mm		302	
	APV	95-96	MANGUERA DE FRENOS	380047	DEL DER	17.16"		405	
	APV	95-96	MANGUERA DE FRENOS	380048	DEL IZQ	17.16"		405	
	APV	95-96	MANGUERA DE FRENOS	380466	TRAS DER	12.5"		421	
	APV	95-96	MANGUERA DE FRENOS	380466	TRAS IZQ	12.5"		421	
	APV	95-96	REP. CIL. MAESTRO Y DE CLUTCH	114196		24.0 mm		561	
	APV	95-96	REPUESTO FRENO DE DISCO	99024	DEL	63.5 mm 2-1/2"		553	
			97-01	CILINDRO DE RUEDA	112341	TRAS IZQ DER	22.2 mm 7/8"		373
			97-01	CILINDRO MAESTRO	390175		24mm	S/POLICE CAR OR TAXI; C/ABS	302
			97-01	CILINDRO MAESTRO	390176		24mm	S/ABS	302
			90-94	MANGUERA DE FRENOS	38587	DER	18.11"		392
			97-01	MANGUERA DE FRENOS	38587	DER	18.11"		392
			97-01	MANGUERA DE FRENOS	38588	IZQ	17.88"	DISCO-TAMBOR	392
			97-99	MANGUERA DE FRENOS	380896	TRAS IZQ	10.6"	CHOCOLATE	428
		97-99	MANGUERA DE FRENOS	380897	TRAS DER	10.6"	CHOCOLATE	428	
		95-96	REPUESTO CILINDRO DE RUEDA	112342		22.2 mm 7/8"			
LUV		97-05	CILINDRO DE CLUTCH	37833		22.2 mm 7/8"	NACIONAL		
		97-05	CILINDRO DE CLUTCH	39804		15.8 mm 5/8"	NACIONAL		
		97-05	CILINDRO DE RUEDA	37599	DER	7/8"		365	
		97-05	CILINDRO DE RUEDA	37599	IZQ	7/8"		365	
		97-05	CILINDRO MAESTRO	390161		23.8 mm 15/16"	2.3 NACIONAL	301	
		97-00	MANGUERA DE FRENOS	38679	DEL IZQ DER	18"	NACIONAL	396	
		01-05	MANGUERA DE FRENOS	380094	DEL	17.05"	NACIONAL	407	
		97-05	PISTÓN FRENO DE DISCO	85484	DEL	60.3 mm 2-3/8"		525	
		97-05	REPUESTO FRENO DE DISCO	2484	DEL	60.3 mm 2-3/8"		542	
MALIBU		97-05	MANGUERA DE FRENOS	380467	DEL DER	12.5"		421	
		97-05	MANGUERA DE FRENOS	380467	DEL IZQ	12.5"		421	
		02-04	MANGUERA DE FRENOS	382337	DEL IZQ	13.38"		458	
		02-04	MANGUERA DE FRENOS	382338	DEL DER	13.38"		458	
		02-12	MANGUERA DE FRENOS	382508	TRAS DER	14"		468	
		02-12	MANGUERA DE FRENOS	382508	TRAS IZQ	14"		468	
		05-12	MANGUERA DE FRENOS	382678	DEL IZQ	15.25"		481	
		05-12	MANGUERA DE FRENOS	382679	DEL DER	15.25"		481	
		05-08	MANGUERA DE FRENOS	382680	DEL IZQ	14.75"		481	
		05-08	MANGUERA DE FRENOS	382680	TRAS IZQ	14.75"		481	
		05-08	MANGUERA DE FRENOS	382681	DEL DER	15.25"		481	
		05-08	MANGUERA DE FRENOS	382681	TRAS DER	15.25"		481	
		02-12	PISTÓN FRENO DE DISCO	851051	N/D	N/D		533	
		97-05	PISTÓN FRENO DE DISCO	853940	DEL	60.3 mm 2-3/8"		535	
	02-12	REPUESTO FRENO DE DISCO	642	DEL	60.3 mm 2-3/8"		536		



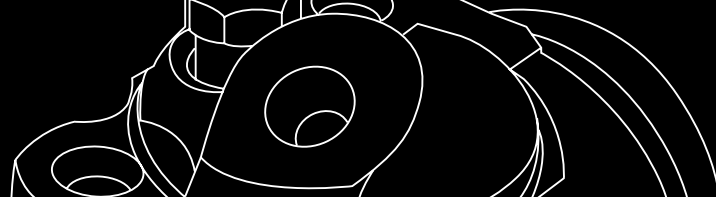

Modelo	Versión	Año	Descripción	Número Lusac	Posición	Diámetro	Notas	Foto Pág.
MALIBU		97-05	REPUESTO FRENO DE DISCO	2394	DEL	60.3 mm 2-3/8"		541
		05-12	REPUESTO FRENO DE DISCO	21069	TRAS	38.1 mm 1-1/2"		550
		02-04	REPUESTO FRENO DE DISCO	21069	TRAS	38.1 mm 1-1/2"		550
	LX, LS V6	97-05	CILINDRO DE RUEDA	370055	DER	7/8"		375
	LX, LS V6	97-05	CILINDRO DE RUEDA	370055	IZQ	7/8"		375
	LX, LS V6	05-08	CILINDRO DE RUEDA	370187	DER	7/8"		380
	LX, LS V6	05-08	CILINDRO DE RUEDA	370187	IZQ	7/8"		380
	LX, LS V6	06-08	CILINDRO DE RUEDA	3700915	DER	22.2 mm 7/8"		384
	LX, LS V6	06-08	CILINDRO DE RUEDA	3700915	IZQ	22.2 mm 7/8"		384
	LX, LS V6	05-05	CILINDRO MAESTRO	390386		1"	3.5 LTS	311
	LX, LS V6	97-01	CILINDRO MAESTRO	390386		1"	C/ABS 3.1 LTS	311
	LX, LS V6	02-04	CILINDRO MAESTRO	390676		24mm	C/ABS 3.1 LTS	322
	LX, LS V6	13-14	CILINDRO MAESTRO	391154		1"		345
	LX, LS V6	09-12	CILINDRO MAESTRO	391186		15/16"	2.2 LTS	347
	LX, LS V6	06-12	CILINDRO MAESTRO	391186		15/16"	3.5 LTS	347
	LX, LS V6	97-01	REP. CIL. MAESTRO Y DE CLUTCH	90386		25.4 mm 1"		559
	LX, LS V6	05-05	REP. CIL. MAESTRO Y DE CLUTCH	90386		25.4 mm 1"		559
			02-10	CILINDRO MAESTRO	390885		23.8 mm 15/16"	3.5 6 V OHV
MATIZ		04-05	PISTÓN FRENO DE DISCO	85496	DEL	48.0 mm 1-57/64"		526
		04-05	REPUESTO FRENO DE DISCO	2496	DEL	48.0 mm 1-57/64"		542
		04-05	CILINDRO DE RUEDA	3700914	IZQ	17.4 mm 11/16"		384
		04-05	REP. CIL. MAESTRO Y DE CLUTCH	904092		20.6 mm 13/16"		563
MATIZ G2		06-11	PISTÓN FRENO DE DISCO	85496	DEL	48.0 mm 1-57/64"		526
		06-11	REPUESTO FRENO DE DISCO	2496	DEL	48.0 mm 1-57/64"		542
		06-11	CILINDRO DE RUEDA	3700914	IZQ	17.4 mm 11/16"		384
		06-11	CILINDRO DE RUEDA	3700914	DER	17.4 mm 11/16"		384
		06-09	CILINDRO MAESTRO	39009914		20.6 mm 13/16"		361
		06-11	REP. CIL. MAESTRO Y DE CLUTCH	904092		20.6 mm 13/16"		563
MAXI CAB		91-93	MANGUERA DE FRENOS	38620	DEL IZQ	25.13"		394
		91-93	MANGUERA DE FRENOS	38621	DEL DER	25.13"		394
		91-93	MANGUERA DE FRENOS	38624	TRAS DER	17.75"		394
		91-93	MANGUERA DE FRENOS	38624	TRAS IZQ	17.75"		394
		91-93	PISTÓN FRENO DE DISCO	85157	DEL	74.6 mm 2-15/16"		520
		91-93	REPUESTO FRENO DE DISCO	2005	DEL	74.6 mm 2-15/16"		538
		91-93	CILINDRO DE RUEDA	116224	DER	30.1 mm 1-3/16"		373
		91-93	CILINDRO DE RUEDA	116224	IZQ	30.1 mm 1-3/16"		373
		91-93	CILINDRO MAESTRO	39649		1-1/4"		294
		91-93	REP. CIL. MAESTRO Y DE CLUTCH	39650		31.7 mm 1-1/4"		557
MERIVA		04-08	PISTÓN FRENO DE DISCO	85258	DEL	54.0 mm 2-1/8"		522
		04-08	REPUESTO FRENO DE DISCO	1449	DEL	54.0 mm 2-1/8"		537
		04-08	CILINDRO DE RUEDA	834	DER	19.0 mm 3/4"		364
		04-08	CILINDRO DE RUEDA	834	IZQ	19.0 mm 3/4"		364
		04-06	CILINDRO MAESTRO	93305031		23.8 mm 15/16"		361





Modelo	Versión	Año	Descripción	Número Lusac	Posición	Diámetro	Notas	Foto Pág.	
CHEVROLET									
MICROBÚS		92-98	MANGUERA DE FRENOS	38572	DEL IZQ	23.63"	CHOCOLATE	392	
		92-94	REPUESTO P/CILINDRO MAESTRO DE CLUTCH	840		23.0 mm 29/32"		557	
		92-94	REPUESTO P/CILINDRO MAESTRO DE CLUTCH	845		20.0 mm		557	
		88-91	MANGUERA DE FRENOS	36765	TRAS DER	14.69"			
		88-91	MANGUERA DE FRENOS	36765	TRAS IZQ	14.69"			
		88-93	MANGUERA DE FRENOS	36952	DEL IZQ	23.13"			
		97-00	MANGUERA DE FRENOS	36952	DEL IZQ	23.13"			
		88-93	MANGUERA DE FRENOS	36957	DEL DER	23.16"		387	
		97-00	MANGUERA DE FRENOS	36957	DEL DER	23.16"		387	
		94-00	MANGUERA DE FRENOS	38808	DEL DER	22.5"		397	
		92-00	MANGUERA DE FRENOS	38823	TRAS DER	22.38"		398	
		92-00	MANGUERA DE FRENOS	38823	TRAS IZQ	22.38"		398	
		94-00	MANGUERA DE FRENOS	38824	DEL IZQ	23.25"		398	
		97-00	MANGUERA DE FRENOS	38872	DEL DER	25.88"		400	
		97-00	MANGUERA DE FRENOS	38873	DEL IZQ	25.88"		400	
		88-00	PISTÓN FRENO DE DISCO	76028	DEL	85.7 mm 3-3/8"		518	
		88-00	REPUESTO FRENO DE DISCO	83297	DEL	85.7 mm 3-3/8"		553	
		88-00	CILINDRO DE RUEDA	079768	DER	30.1 mm 1-3/16"		371	
		88-00	CILINDRO DE RUEDA	079768	IZQ	30.1 mm 1-3/16"		371	
		94-00	CILINDRO MAESTRO	103238		34.0 mm			
		88-91	CILINDRO MAESTRO	108145		33.3 mm 1-5/16"			
		97-00	CILINDRO MAESTRO	108145		33.3 mm 1-5/16"			
		92-93	CILINDRO MAESTRO	120590		31.7 mm 1-1/4"		298	
		97-00	CILINDRO MAESTRO	120590		31.7 mm 1-1/4"		298	
		94-00	REP. CIL. MAESTRO Y DE CLUTCH	105838		34.0 mm		560	
		92-93	REP. CIL. MAESTRO Y DE CLUTCH	120591		31.7 mm 1-1/4"		562	
		97-00	REP. CIL. MAESTRO Y DE CLUTCH	120591		31.7 mm 1-1/4"		562	
		88-91	REP. CIL. MAESTRO Y DE CLUTCH	113441A		33.3 mm 1-5/16"		563	
		97-00	REP. CIL. MAESTRO Y DE CLUTCH	113441A		33.3 mm 1-5/16"		563	
	MONTECARLO		81-84	KIT DE PISTÓN Y REPUESTO FD	742367	DEL	63.5 mm 2-1/2"		
	OLDSMOBILE 88		92-92	MANGUERA DE FRENOS	38253	DEL IZQ	18.25"		390
			92-92	MANGUERA DE FRENOS	38262	DEL DER	18.31"		390
		92-92	MANGUERA DE FRENOS	38951	TRAS DER	12.5"		402	
		94-95	MANGUERA DE FRENOS	38951	TRAS DER	12.5"		402	
		92-92	MANGUERA DE FRENOS	38951	TRAS IZQ	12.5"		402	
		94-95	MANGUERA DE FRENOS	38951	TRAS IZQ	12.5"		402	
		94-95	MANGUERA DE FRENOS	380261	DEL IZQ	18.25"		410	
		94-95	MANGUERA DE FRENOS	380271	DEL DER	12.5"		411	
		92-92	REPUESTO FRENO DE DISCO	99024	DEL	63.5 mm 2-1/2"		553	
		94-95	REPUESTO FRENO DE DISCO	99024	DEL	63.5 mm 2-1/2"		553	
		92-92	CILINDRO DE RUEDA	37855	DER	23.8 mm 15/16"		367	
		94-95	CILINDRO DE RUEDA	37855	DER	23.8 mm 15/16"		367	
		92-92	CILINDRO DE RUEDA	37855	IZQ	23.8 mm 15/16"		367	
		94-95	CILINDRO DE RUEDA	37855	IZQ	23.8 mm 15/16"		367	
	92-92	CILINDRO MAESTRO	39954		1"		296		
	92-92	CILINDRO MAESTRO	39955		1"	C/ABS	296		





Modelo	Versión	Año	Descripción	Número Lusac	Posición	Diámetro	Notas	Foto Pág.
OLDSMOBILE 88		94-95	CILINDRO MAESTRO	390186		1"		303
OPTRA		06-10	KIT DE PISTÓN Y REPUESTO FD	742408	TRAS	65.9 mm 2-19/32"		
		06-10	PISTÓN FRENO DE DISCO	85209	DEL	54.0 mm 2-1/8"		521
		06-10	PISTÓN FRENO DE DISCO	851003	DEL	65.9 mm 2-19/32"		530
		06-10	REPUESTO FRENO DE DISCO	21003	TRAS	65.9 mm 2-19/32"		545
		06-10	REPUESTO FRENO DE DISCO	21068	DEL	54.0 mm 2-1/8"		550
P-30		92-94	REPUESTO P/CILINDRO MAESTRO DE CLUTCH	840		23.0 mm 29/32"		557
		92-94	REPUESTO P/CILINDRO MAESTRO DE CLUTCH	845		20.0 mm		557
	PANEL	82-92	CILINDRO DE RUEDA	079768	DER	30.1 mm 1-3/16"		371
	PANEL	94-03	CILINDRO DE RUEDA	079768	DER	30.1 mm 1-3/16"		371
	PANEL	82-92	CILINDRO DE RUEDA	079768	IZQ	30.1 mm 1-3/16"		371
	PANEL	94-03	CILINDRO DE RUEDA	079768	IZQ	30.1 mm 1-3/16"		371
	PANEL	82-92	REP. CIL. MAESTRO Y DE CLUTCH	86511		33.3 mm 1-5/16"		
	PANEL	97-98	REP. CIL. MAESTRO Y DE CLUTCH	86511		33.3 mm 1-5/16"		
	PANEL	96-00	REP. CIL. MAESTRO Y DE CLUTCH	90279		31.7 mm 1-1/4"		558
	PANEL	94-98	REP. CIL. MAESTRO Y DE CLUTCH	105838		34.0 mm		560
	PANEL	82-92	REP. CIL. MAESTRO Y DE CLUTCH	113441A		33.3 mm 1-5/16"		563
PANEL	97-98	REP. CIL. MAESTRO Y DE CLUTCH	113441A		33.3 mm 1-5/16"		563	
P3500		92-94	REPUESTO P/CILINDRO MAESTRO DE CLUTCH	840		23.0 mm 29/32"		557
		92-94	REPUESTO P/CILINDRO MAESTRO DE CLUTCH	845		20.0 mm		557
PANEL	P-30	82-92	CILINDRO MAESTRO	98953		33.3 mm 1-5/16"		297
	P-30	97-98	CILINDRO MAESTRO	98953		33.3 mm 1-5/16"		297
	P-30	94-98	CILINDRO MAESTRO	103238		34.0 mm		
	P-30	82-92	CILINDRO MAESTRO	108145		33.3 mm 1-5/16"	HYDROBOOSTER	
	P-30	97-98	CILINDRO MAESTRO	108145		33.3 mm 1-5/16"	HYDROBOOSTER	
	P-30	01-03	CILINDRO MAESTRO	390278		40mm		307
	P-30	96-00	CILINDRO MAESTRO	390279		1-1/4"		307
	P-30	82-92	MANGUERA DE FRENOS	1197	TRAS DER	14 11/16"		385
	P-30	97-98	MANGUERA DE FRENOS	1197	TRAS DER	14 11/16"		385
	P-30	82-92	MANGUERA DE FRENOS	1197	TRAS IZQ	14 11/16"		385
	P-30	97-98	MANGUERA DE FRENOS	1197	TRAS IZQ	14 11/16"		385
	P-30	82-92	MANGUERA DE FRENOS	36954	DEL IZQ	23.25"		387
	P-30	97-98	MANGUERA DE FRENOS	36954	DEL IZQ	23.25"		387
	P-30	82-92	MANGUERA DE FRENOS	38563	DEL DER	24.25"		
	P-30	97-98	MANGUERA DE FRENOS	38563	DEL DER	24.25"		
	P-30	01-03	MANGUERA DE FRENOS	38624	TRAS IZQ	17.75"		394
	P-30	97-03	MANGUERA DE FRENOS	38808	DEL DER	22.5"		397
	P-30	97-03	MANGUERA DE FRENOS	38824	DEL IZQ	23.25"		398
	P-30	94-98	MANGUERA DE FRENOS	380282	DEL DER	37.5"		
	P-30	94-98	MANGUERA DE FRENOS	380282	DEL IZQ	37.5"		
	P-30	82-92	PISTÓN FRENO DE DISCO	76028	DEL	85.7 mm 3-3/8"		518
	P-30	94-98	PISTÓN FRENO DE DISCO	76028	DEL	85.7 mm 3-3/8"		518





Modelo	Versión	Año	Descripción	Número Lusac	Posición	Diámetro	Notas	Foto Pág.
CHEVROLET								
PANEL	P-30	98-03	PISTÓN FRENO DE DISCO	85206	DEL	86.1 mm 3-25/64"		521
	P-30	98-03	REPUESTO FRENO DE DISCO	2033	DEL	86.1 mm 3-25/64"		538
	P-30	82-92	REPUESTO FRENO DE DISCO	83297	DEL	85.7 mm 3-3/8"		553
	P-30	94-98	REPUESTO FRENO DE DISCO	83297	DEL	85.7 mm 3-3/8"		553
S-10	PICK UP	03-04	CILINDRO DE RUEDA	37854	DER	7/8"		367
	PICK UP	03-04	CILINDRO DE RUEDA	37854	IZQ	7/8"		367
	PICK UP	95-02	CILINDRO DE RUEDA	37967	DER	13/16"		369
	PICK UP	95-02	CILINDRO DE RUEDA	37967	IZQ	13/16"		369
	PICK UP	95-95	CILINDRO MAESTRO	39571		24mm & 36mm		294
	PICK UP	96-97	CILINDRO MAESTRO	390320		36mm & 24mm		308
	PICK UP	98-99	CILINDRO MAESTRO	390427		1"		313
	PICK UP	00-04	CILINDRO MAESTRO	390571		1"		319
	PICK UP	95-97	MANGUERA DE FRENOS	38869	DEL IZQ	21.88"		400
	PICK UP	95-97	MANGUERA DE FRENOS	38870	DEL DER	21.88"		400
	PICK UP	95-04	MANGUERA DE FRENOS	38871	TRAS IZQ	18.88"		400
	PICK UP	95-99	MANGUERA DE FRENOS	380280	DEL DER	12.13"		411
	PICK UP	95-99	MANGUERA DE FRENOS	380280	DEL IZQ	12.13"		411
	PICK UP	98-99	MANGUERA DE FRENOS	381032	DEL IZQ	19.12"		431
	PICK UP	98-99	MANGUERA DE FRENOS	381033	DEL DER	19.12"		431
	PICK UP	00-04	MANGUERA DE FRENOS	381345	DEL DER	12.37"		443
	PICK UP	00-04	MANGUERA DE FRENOS	381345	DEL IZQ	12.37"		443
	PICK UP	95-04	PISTÓN FRENO DE DISCO	76033	DEL	63.5 mm 2-1/2"		518
	PICK UP	95-95	REP. CIL. MAESTRO Y DE CLUTCH	107051		24.0 mm		560
	PICK UP	95-04	REPUESTO FRENO DE DISCO	99024	DEL	63.5 mm 2-1/2"		553
		84-91	CILINDRO DE CLUTCH	37728		20.5 mm		
		90-91	CILINDRO DE CLUTCH	37816		20.6 mm 13/16"		
		95-04	KIT DE PISTÓN Y REPUESTO FD	742367	DEL	63.5 mm 2-1/2"		
SERIES C Y K		85-86	CILINDRO DE CLUTCH	39732		17.8 mm 45/64"		
SERIES G		85-87	CILINDRO DE CLUTCH	39732		17.8 mm 45/64"	CHOCOLATE	
SERIES R Y V		85-91	CILINDRO DE CLUTCH	39732		17.8 mm 45/64"		
SILVERADO		95-99	MANGUERA DE FRENOS	38620	DEL IZQ	25.13"		394
		95-99	MANGUERA DE FRENOS	38621	DEL DER	25.13"		394
		95-99	MANGUERA DE FRENOS	38624	TRAS IZQ	17.75"		394
		95-99	MANGUERA DE FRENOS	380752	DEL IZQ	22.75"		427
		95-99	MANGUERA DE FRENOS	380753	DEL DER	22.75"		427
		95-99	PISTÓN FRENO DE DISCO	85157	DEL	74.6 mm 2-15/16"		520
		95-99	REPUESTO FRENO DE DISCO	2005	DEL	74.6 mm 2-15/16"		538
		92-93	CILINDRO DE CLUTCH	350042	SUP	17.7 mm		
		92-93	CILINDRO DE CLUTCH	360027	INF	20.0 mm		
		95-99	CILINDRO DE RUEDA	116224	DER	30.1 mm 1-3/16"		373
		95-99	CILINDRO DE RUEDA	116224	IZQ	30.1 mm 1-3/16"		373
		95-99	CILINDRO MAESTRO	390259		40mm & 1/8"		306
		95-99	REP. CIL. MAESTRO Y DE CLUTCH	104459		28.5 mm 1-1/8"		560
	1500	00-01	MANGUERA DE FRENOS	381272	TRAS IZQ	22.5"		439
	1500	03-06	MANGUERA DE FRENOS	381272	TRAS IZQ	22.5"		439

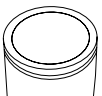



Modelo	Versión	Año	Descripción	Número Lusac	Posición	Diámetro	Notas	Foto Pág.
SILVERADO	1500	00-01	MANGUERA DE FRENOS	381273	TRAS IZQ	14.25"		439
	1500	03-06	MANGUERA DE FRENOS	381273	TRAS IZQ	14.25"		439
	1500	00-01	MANGUERA DE FRENOS	381298	DEL IZQ	28.15"		441
	1500	03-06	MANGUERA DE FRENOS	381298	DEL IZQ	28.15"		441
	1500	00-01	MANGUERA DE FRENOS	381299	DEL DER	28.15"		441
	1500	03-06	MANGUERA DE FRENOS	381299	DEL DER	28.15"		441
	1500	03-06	MANGUERA DE FRENOS	382415	DEL IZQ	29.5"		464
	1500	03-06	MANGUERA DE FRENOS	382416	DEL DER	30.5"		464
	1500	07-08	MANGUERA DE FRENOS	382418	DEL DER	30.75"		464
	1500	03-06	MANGUERA DE FRENOS	382656	TRAS IZQ	18.12"		479
	1500	03-06	MANGUERA DE FRENOS	382657	TRAS DER	17.31"		480
	1500	00-01	PISTÓN FRENO DE DISCO	2160	TRAS	50.8 mm 2"		517
	1500	03-06	PISTÓN FRENO DE DISCO	2160	TRAS	50.8 mm 2"		517
	1500	00-01	PISTÓN FRENO DE DISCO	85157	DEL	74.6 mm 2-15/16"	CALIPER DOBLE PISTON	520
	1500	03-06	PISTÓN FRENO DE DISCO	85157	DEL	74.6 mm 2-15/16"	CALIPER DOBLE PISTON	520
	1500	00-01	REPUESTO FRENO DE DISCO	2005	DEL	74.6 mm 2-15/16"	CALIPER DOBLE PISTON	538
	1500	03-06	REPUESTO FRENO DE DISCO	2005	DEL	74.6 mm 2-15/16"	CALIPER DOBLE PISTON	538
	1500	00-01	REPUESTO FRENO DE DISCO	2159	TRAS	50.8 mm 2"		540
	1500	03-14	REPUESTO FRENO DE DISCO	2159	TRAS	50.8 mm 2"		540
	1500	07-14	REPUESTO FRENO DE DISCO	21045	DEL	50.8mm 2"		548
	1500 HD	02-02	CILINDRO MAESTRO	390541		34mm	C/BOOSTER DE VACÍO	317
	1500 HD	02-02	CILINDRO MAESTRO	390542		37mm	HYDROBOOSTER	318
	1500 HD	02-02	MANGUERA DE FRENOS	381272	CTR	22.5"		439
	1500 HD	02-02	MANGUERA DE FRENOS	382417	IZQ	31.25"		464
	1500 HD	02-02	MANGUERA DE FRENOS	382419	DER	31.25"		465
	1500	01-02	CILINDRO DE CLUTCH	360107		Concentrico		
	1500	07-08	CILINDRO DE RUEDA	370180	DER	15/16"	2X4, 4X4	380
	1500	07-08	CILINDRO DE RUEDA	370180	IZQ	15/16"	2X4, 4X4	380
	1500	03-08	CILINDRO DE RUEDA	370181	DER	26.9 mm 1-1/16"	2X4, 4X4	380
	1500	03-08	CILINDRO DE RUEDA	370181	IZQ	26.9 mm 1-1/16"	2X4, 4X4	380
	1500	09-14	CILINDRO DE RUEDA	370200	DER	1 1/16"	2X4, 4X4	381
	1500	09-14	CILINDRO DE RUEDA	370200	IZQ	1 1/16"	2X4, 4X4	381
	1500	09-14	CILINDRO DE RUEDA	370201	DER	15/16"	2X4, 4X4	381
	1500	09-14	CILINDRO DE RUEDA	370201	IZQ	15/16"	2X4, 4X4	381
	1500	99-06	CILINDRO MAESTRO	390541		34mm	2X4, 4X4	317
	1500	99-06	CILINDRO MAESTRO	390542		37mm	2X4, 4X4	318
	1500	03-06	CILINDRO MAESTRO	390843		34mm	2X4, 4X4	331
	1500	05-08	CILINDRO MAESTRO	390930		1-1/8"	2X4, 4X4	335
	1500	03-08	CILINDRO MAESTRO	390986		1-1/4"	2X4, 4X4	338
	1500	07-07	CILINDRO MAESTRO	391080		28.5 mm 1-1/8"	S/C ACTIVO DE FRENOS	341
	1500	07-14	CILINDRO MAESTRO	391169		1-1/8"	2X4, 4X4	346
	1500	09-14	CILINDRO MAESTRO	391172		1-1/4"	2X4, 4X4	346
	1500	00-06	KIT DE PISTÓN Y REPUESTO FD	742344	DEL	50.8 mm 2"	2X4, 4X4	
	1500	00-06	KIT DE PISTÓN Y REPUESTO FD	742351	DEL	74.6 mm 2-15/16"		
	1500	99-99	MANGUERA DE FRENOS	381272	CTR	22.5"		439





Modelo	Versión	Año	Descripción	Número Lusac	Posición	Diámetro	Notas	Foto Pág.
CHEVROLET								
SILVERADO	1500	02-02	MANGUERA DE FRENOS	381272	CTR	22.5"		439
	1500	99-99	MANGUERA DE FRENOS	381273	IZQ	14.25"		439
	1500	99-99	MANGUERA DE FRENOS	381298	IZQ	28.15"	4X2	441
	1500	02-02	MANGUERA DE FRENOS	381298	IZQ	28.15"	4X2	441
	1500	99-99	MANGUERA DE FRENOS	381299	DER	28.15"	4X2	441
	1500	02-02	MANGUERA DE FRENOS	381299	DER	28.15"	4X2	441
	1500	02-02	MANGUERA DE FRENOS	382396	IZQ	16.38"		463
	1500	02-03	MANGUERA DE FRENOS	382397	TRAS IZQ	19"		463
	1500	02-02	MANGUERA DE FRENOS	382398	DER	17.19"		463
	1500	99-99	MANGUERA DE FRENOS	382412	IZQ	28.38"	4X4	464
	1500	02-02	MANGUERA DE FRENOS	382412	IZQ	28.38"	4X4	464
	1500	99-99	MANGUERA DE FRENOS	382414	DER	27.38"	4X4	464
	1500	02-02	MANGUERA DE FRENOS	382414	DER	27.38"	4X4	464
	1500 HD	01-02	CILINDRO DE CLUTCH	360107		Concentrico		
	2500	96-01	MANGUERA DE FRENOS	381273	TRAS IZQ	14.25"		439
	2500	03-06	MANGUERA DE FRENOS	381273	TRAS IZQ	14.25"		439
	2500	96-01	MANGUERA DE FRENOS	381298	DEL IZQ	28.15"		441
	2500	03-06	MANGUERA DE FRENOS	381298	DEL IZQ	28.15"		441
	2500	96-01	MANGUERA DE FRENOS	381299	DEL DER	28.15"		441
	2500	03-06	MANGUERA DE FRENOS	381299	DEL DER	28.15"		441
	2500	03-04	MANGUERA DE FRENOS	382396	TRAS IZQ	16.38"		463
	2500	03-04	MANGUERA DE FRENOS	382398	TRAS DER	17.19"		463
	2500	96-99	MANGUERA DE FRENOS	382399	TRAS DER	22"		464
	2500	05-06	MANGUERA DE FRENOS	382399	TRAS DER	22"		464
	2500	96-99	MANGUERA DE FRENOS	382412	DEL IZQ	28.38"		464
	2500	96-99	MANGUERA DE FRENOS	382414	DEL DER	27.38"		464
	2500	00-01	MANGUERA DE FRENOS	382415	DEL IZQ	29.5"		464
	2500	03-06	MANGUERA DE FRENOS	382415	DEL IZQ	29.5"		464
	2500	00-01	MANGUERA DE FRENOS	382416	DEL DER	30.5"		464
	2500	03-06	MANGUERA DE FRENOS	382416	DEL DER	30.5"		464
	2500	96-01	PISTÓN FRENO DE DISCO	2160	TRAS	50.8 mm 2"	CALIPER DOBLE PISTON	517
	2500	03-10	PISTÓN FRENO DE DISCO	2160	TRAS	50.8 mm 2"	CALIPER DOBLE PISTON	517
	2500	96-01	PISTÓN FRENO DE DISCO	85157	DEL	74.6 mm 2-15/16"	CALIPER DOBLE PISTON	520
	2500	03-06	PISTÓN FRENO DE DISCO	85157	DEL	74.6 mm 2-15/16"	CALIPER DOBLE PISTON	520
	2500	96-01	REPUESTO FRENO DE DISCO	2005	DEL	74.6 mm 2-15/16"	CALIPER DOBLE PISTON	538
	2500	03-06	REPUESTO FRENO DE DISCO	2005	DEL	74.6 mm 2-15/16"	CALIPER DOBLE PISTON	538
	2500	96-01	REPUESTO FRENO DE DISCO	2159	TRAS	50.8 mm 2"	CALIPER DOBLE PISTON	540
	2500	03-10	REPUESTO FRENO DE DISCO	2159	TRAS	50.8 mm 2"	CALIPER DOBLE PISTON	540
	2500	07-10	REPUESTO FRENO DE DISCO	21045	DEL	50.8mm 2"		548
	2500 HD	02-02	CILINDRO MAESTRO	390542		37mm		318
	2500 HD	02-02	MANGUERA DE FRENOS	381272	CTR	22.5"		439
	2500 HD	02-02	MANGUERA DE FRENOS	382399	DER	22"		464
	2500 HD	02-02	MANGUERA DE FRENOS	382417	IZQ	31.25"		464
	2500 HD	02-02	MANGUERA DE FRENOS	382419	DER	31.25"		465
	2500	96-01	CILINDRO DE RUEDA	79767	IZQ	26.9 mm 1-1/16"	2X4, 4X4	371
2500	96-01	CILINDRO DE RUEDA	116359	IZQ	25.4 mm 1"	2X4, 4X4	373	
2500	96-01	CILINDRO MAESTRO	390541		34mm	2X4, 4X4	317	

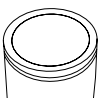



Modelo	Versión	Año	Descripción	Número Lusac	Posición	Diámetro	Notas	Foto Pág.
SILVERADO	2500	03-06	CILINDRO MAESTRO	390541		34mm	2X4, 4X4	317
	2500	96-06	CILINDRO MAESTRO	390542		37mm		318
	2500	03-06	CILINDRO MAESTRO	390818		37mm	2X4, 4X4	330
	2500	03-06	CILINDRO MAESTRO	390986		1-1/4"	2X4, 4X4	338
	2500	07-08	CILINDRO MAESTRO	391081		37mm	2X4, 4X4	341
	2500	07-08	CILINDRO MAESTRO	391082		37mm	2X4, 4X4	342
	2500	09-12	CILINDRO MAESTRO	391183		1-1/2"	2X4, 4X4	347
	2500	09-14	CILINDRO MAESTRO	391184		1-1/2"	2X4, 4X4	347
	2500	00-01	CILINDRO MAESTRO	18060790		37.0 mm	2X4, 4X4	360
	2500	01-10	KIT DE PISTÓN Y REPUESTO FD	742344	DEL	50.8 mm 2"	2X4, 4X4	
	2500	00-06	KIT DE PISTÓN Y REPUESTO FD	742351	DEL	74.6 mm 2-15/16"		
	2500	02-02	MANGUERA DE FRENOS	381272	CTR	22.5"		439
	2500	02-02	MANGUERA DE FRENOS	382399	DER	22"		464
	2500	02-02	MANGUERA DE FRENOS	382417	IZQ	31.25"		464
	2500	02-02	MANGUERA DE FRENOS	382419	DER	31.25"		465
	3500 CLASSIC	07-07	CILINDRO MAESTRO	390818		37mm		330
	3500 CLASSIC	07-07	MANGUERA DE FRENOS	381624	IZQ	12.75"		451
	3500 CLASSIC	07-07	MANGUERA DE FRENOS	382399	DER	22"		464
	3500 CLASSIC	07-07	MANGUERA DE FRENOS	382417	IZQ	31.25"		464
	3500 CLASSIC	07-07	MANGUERA DE FRENOS	382419	DER	31.25"		465
	3500 CLASSIC	07-07	MANGUERA DE FRENOS	382696	IZQ	16.19"		483
	3500 HD	07-08	CILINDRO MAESTRO	391081		37mm	C DE FRENOS DE REMOLQUE	341
	3500 HD	07-08	CILINDRO MAESTRO	391082		37mm	S/C DE FRENOS DE REMOLQUE	342
	3500 HD	09-13	CILINDRO MAESTRO	391183		1-1/2"		347
	3500	01-02	CILINDRO DE CLUTCH	360107		Concentrico	NACIONAL	
	3500	01-02	CILINDRO MAESTRO	390542		37mm		318
	3500	03-06	CILINDRO MAESTRO	390818		37mm		330
	3500	01-06	KIT DE PISTÓN Y REPUESTO FD	742344	DEL	50.8 mm 2"	2X4, 4X4	
	3500	96-08	KIT DE PISTÓN Y REPUESTO FD	742351	DEL	74.6 mm 2-15/16"		
	3500	01-04	MANGUERA DE FRENOS	381272	CTR	22.5"		439
	3500	03-07	MANGUERA DE FRENOS	381298	DEL IZQ	28.15"		441
	3500	03-07	MANGUERA DE FRENOS	381299	DEL DER	28.15"		441
	3500	01-07	MANGUERA DE FRENOS	381624	IZQ	12.75"		451
	3500	03-07	MANGUERA DE FRENOS	381624	TRAS IZQ	12.75"		451
	3500	01-06	MANGUERA DE FRENOS	382399	DER	22"		464
	3500	03-07	MANGUERA DE FRENOS	382399	TRAS DER	22"		464
	3500	03-07	MANGUERA DE FRENOS	382417	DEL IZQ	31.25"		464
	3500	01-06	MANGUERA DE FRENOS	382417	IZQ	31.25"		464
	3500	03-07	MANGUERA DE FRENOS	382419	DEL DER	31.25"		465
	3500	01-06	MANGUERA DE FRENOS	382419	DER	31.25"		465
	3500	05-06	MANGUERA DE FRENOS	382696	IZQ	16.19"		483
	3500	03-06	PISTÓN FRENO DE DISCO	85157	DEL	74.6 mm 2-15/16"	CALIPER DOBLE PISTON	520
	3500	03-07	PISTÓN FRENO DE DISCO	85471	DEL Y TRAS	59.5 mm 2-11/32"	CALIPER DOBLE PISTON	524





Modelo	Versión	Año	Descripción	Número Lusac	Posición	Diámetro	Notas	Foto Pág.
CHEVROLET								
SILVERADO	3500	03-07	PISTÓN FRENO DE DISCO	854790	DEL Y TRAS	65.9 mm 2-19/32"	CALIPER DOBLE PISTON	535
	3500	03-06	REPUESTO FRENO DE DISCO	2005	DEL	74.6 mm 2-15/16"	CALIPER DOBLE PISTON	538
	3500	03-07	REPUESTO FRENO DE DISCO	2479	DEL Y TRAS	65.9 mm 2-19/32"	CALIPER DOBLE PISTON	
	K2500 CLASSIC	99-00	CILINDRO DE RUEDA	79767	TRAS IZQ DER	26.9 mm 1-1/16"		371
	K2500 CLASSIC	99-00	CILINDRO MAESTRO	390257		1-1/4"		306
	K2500 CLASSIC	99-00	CILINDRO MAESTRO	390259		40mm & 1/8"		306
	K2500 CLASSIC	99-00	MANGUERA DE FRENOS	38624	CTR	17.75"		394
	K2500 CLASSIC	99-00	MANGUERA DE FRENOS	380533	IZQ	25.5"		424
	K2500 CLASSIC	99-00	MANGUERA DE FRENOS	380534	DER	25.5"		424
SONIC		12-14	CILINDRO DE RUEDA	370226	TRAS IZQ	13/16"	USA	382
		12-14	CILINDRO DE RUEDA	370226	TRAS DER	13/16"	USA	382
		13-15	CILINDRO DE RUEDA	3700923	TRAS DER	20.6 mm 13/16"		
		13-15	CILINDRO DE RUEDA	3700923	TRAS IZQ	20.6 mm 13/16"		
SONORA		00-02	MANGUERA DE FRENOS	381380	TRAS DER	16.05"		445
		00-02	MANGUERA DE FRENOS	381380	TRAS IZQ	16.05"		445
		00-06	PISTÓN FRENO DE DISCO	2160	DEL	50.8 mm 2"	CALIPER DOBLE PISTON	517
		00-06	PISTÓN FRENO DE DISCO	85119	TRAS	45.0 mm		519
		00-06	PISTÓN FRENO DE DISCO	85157	DEL	74.6 mm 2-15/16"	CALIPER DOBLE PISTON	520
		00-06	PISTÓN FRENO DE DISCO	851110	TRAS	44.4 mm 1-3/4"	CALIPER DOBLE PISTON	534
		00-06	REPUESTO FRENO DE DISCO	2005	DEL	74.6 mm 2-15/16"	CALIPER DOBLE PISTON	538
		00-06	REPUESTO FRENO DE DISCO	2111	TRAS	44.4 mm 1-3/4"	CALIPER DOBLE PISTON	
		00-06	REPUESTO FRENO DE DISCO	2159	DEL	50.8 mm 2"	CALIPER DOBLE PISTON	540
		00-06	REPUESTO FRENO DE DISCO	2475	TRAS	46.0 mm 1-13/16"	CALIPER DOBLE PISTON	541
		00-00	CILINDRO DE RUEDA	116224	DER	30.1 mm 1-3/16"		373
		00-00	CILINDRO DE RUEDA	116224	IZQ	30.1 mm 1-3/16"		373
		00-02	CILINDRO MAESTRO	390259		40mm & 1/8"		306
		01-02	CILINDRO MAESTRO	390542		37mm		318
		00-06	KIT DE PISTÓN Y REPUESTO FD	742344	DEL	50.8 mm 2"		
		00-06	KIT DE PISTÓN Y REPUESTO FD	742351	DEL	74.6 mm 2-15/16"		
		00-06	KIT DE PISTÓN Y REPUESTO FD	742369	TRAS	45.0 mm		
		00-06	KIT DE PISTÓN Y REPUESTO FD	742385	TRAS	44.4 mm 1-3/4"	CON CALIPER DE DOBLE PISTON	
		00-00	REP. CIL. MAESTRO Y DE CLUTCH	104459		28.5 mm 1-1/8"		560
	SPARK		11-12	CILINDRO DE RUEDA	834	IZQ	19.0 mm 3/4"	
		11-12	CILINDRO DE RUEDA	834	DER	19.0 mm 3/4"		364
		13-14	CILINDRO DE RUEDA	370103	TRAS IZQ	13/16"		376
		13-14	CILINDRO DE RUEDA	370103	TRAS DER	13/16"		376
		11-12	PISTÓN FRENO DE DISCO	851046	DEL	52.0mm 2-3/64"		532

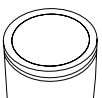

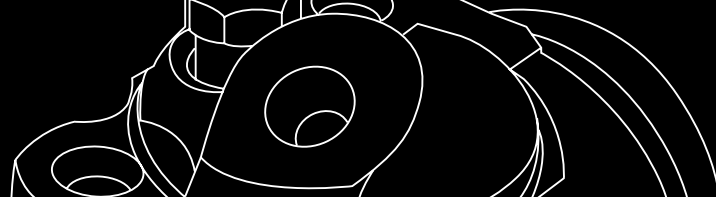

Modelo	Versión	Año	Descripción	Número Lusac	Posición	Diámetro	Notas	Foto Pág.
SPARK		11-12	REPUESTO FRENO DE DISCO	21046	DEL	52.0mm 2-3/64"		548
SUBURBAN	1500	87-87	CILINDRO DE RUEDA	51088	DER	25.4 mm 1"	ESTE VEHICULO PUEDE LLEVAR EL CILINDRO DE RUEDA 37080	370
	1500	87-87	CILINDRO DE RUEDA	51088	IZQ	25.4 mm 1"	ESTE VEHICULO PUEDE LLEVAR EL CILINDRO DE RUEDA 37080	370
	1500	88-88	CILINDRO DE RUEDA	116263	DER	28.5 mm 1-1/8"		373
	1500	88-88	CILINDRO DE RUEDA	116263	IZQ	28.5 mm 1-1/8"		373
	1500	88-00	CILINDRO DE RUEDA	116359	DER	25.4 mm 1"		373
	1500	88-00	CILINDRO DE RUEDA	116359	IZQ	25.4 mm 1"		373
	1500	88-88	CILINDRO MAESTRO	39646		28.6mm & 40mm		294
	1500	88-94	CILINDRO MAESTRO	39646		28.6mm & 40mm		294
	1500	87-87	CILINDRO MAESTRO	104516		28.5 & 40.0 mm		297
	1500	00-00	CILINDRO MAESTRO	390259		40mm & 1/8"		306
	1500	95-99	CILINDRO MAESTRO	390259		40mm & 1/8"		306
	1500	01-03	CILINDRO MAESTRO	390542		37mm		318
	1500	09-14	CILINDRO MAESTRO	391172		1-1/4"		346
	1500	87-87	MANGUERA DE FRENOS	1197	TRAS IZQ	14 11/16"		385
	1500	87-87	MANGUERA DE FRENOS	36954	DEL IZQ	23.25"		387
	1500	88-01	MANGUERA DE FRENOS	38620	DEL IZQ	25.13"		394
	1500	88-01	MANGUERA DE FRENOS	38621	DEL DER	25.13"		394
	1500	88-00	MANGUERA DE FRENOS	38624	TRAS IZQ	17.75"		394
	1500	01-03	MANGUERA DE FRENOS	381380	TRAS DER	16.05"		445
	1500	01-03	MANGUERA DE FRENOS	381380	TRAS IZQ	16.05"		445
	1500	00-06	MANGUERA DE FRENOS	382412	DEL IZQ	28.38"		464
	1500	00-06	MANGUERA DE FRENOS	382414	DEL DER	27.38"		464
	1500	01-06	MANGUERA DE FRENOS	382610	TRAS IZQ	11.56"		476
	1500	00-06	PISTÓN FRENO DE DISCO	2160	DEL	50.8 mm 2"		517
	1500	87-88	PISTÓN FRENO DE DISCO	76008	DEL	74.6 mm 2-15/16"		518
	1500	00-06	PISTÓN FRENO DE DISCO	85119	TRAS	45.0 mm		519
	1500	88-06	PISTÓN FRENO DE DISCO	85157	DEL	74.6 mm 2-15/16"	CALIPER DOBLE PISTON	520
	1500	04-06	PISTÓN FRENO DE DISCO	851110	TRAS	44.4 mm 1-3/4"	CALIPER DOBLE PISTON	534
	1500	88-94	REP. CIL. MAESTRO Y DE CLUTCH	1737		28.5 mm 1-1/8"		557
	1500	87-87	REP. CIL. MAESTRO Y DE CLUTCH	104459		28.5 mm 1-1/8"		560
	1500	95-00	REP. CIL. MAESTRO Y DE CLUTCH	104459		28.5 mm 1-1/8"		560
	1500	88-06	REPUESTO FRENO DE DISCO	2005	DEL	74.6 mm 2-15/16"	CALIPER DOBLE PISTON	538
1500	04-06	REPUESTO FRENO DE DISCO	2111	TRAS	44.4 mm 1-3/4"	CALIPER DOBLE PISTON		
1500	00-06	REPUESTO FRENO DE DISCO	2119	DEL	45.0 mm		540	
1500	00-14	REPUESTO FRENO DE DISCO	2159	TRAS	50.8 mm 2"		540	
1500	07-14	REPUESTO FRENO DE DISCO	21045	DEL	50.8mm 2"		548	
1500	87-88	REPUESTO FRENO DE DISCO	59176	DEL	74.6 mm 2-15/16"		552	





Modelo	Versión	Año	Descripción	Número Lusac	Posición	Diámetro	Notas	Foto Pág.
CHEVROLET								
SUBURBAN	2500	00-02	CILINDRO DE RUEDA	116359	DER	25.4 mm 1"		373
	2500	00-02	CILINDRO DE RUEDA	116359	IZQ	25.4 mm 1"		373
	2500	00-02	CILINDRO MAESTRO	390542		37mm		318
	2500	03-06	CILINDRO MAESTRO	390818		37mm		330
	2500	09-10	CILINDRO MAESTRO	391183		1-1/2"		347
	2500	11-14	CILINDRO MAESTRO	391184		1-1/2"		347
	2500	00-02	MANGUERA DE FRENOS	38624	TRAS IZQ	17.75"		394
	2500	07-14	MANGUERA DE FRENOS	382363	TRAS IZQ	22"		460
	2500	07-14	MANGUERA DE FRENOS	382364	TRAS DER	20.38"		460
	2500	07-14	MANGUERA DE FRENOS	382365	DEL IZQ	19.38"		460
	2500	07-14	MANGUERA DE FRENOS	382366	DEL DER	25.5"		460
	2500	00-06	MANGUERA DE FRENOS	382399	TRAS DER	22"		464
	2500	00-06	MANGUERA DE FRENOS	382417	DEL IZQ	31.25"		464
	2500	00-06	MANGUERA DE FRENOS	382419	DEL DER	31.25"		465
	2500	03-06	MANGUERA DE FRENOS	382602	TRAS IZQ	16.5"		476
	2500	00-06	PISTÓN FRENO DE DISCO	2160	TRAS	50.8 mm 2"		517
	2500	00-04	PISTÓN FRENO DE DISCO	85119	DEL	45.0 mm		519
	2500	00-06	PISTÓN FRENO DE DISCO	85157	DEL	74.6 mm 2-15/16"	CALIPER DOBLE PISTON	520
	2500	05-06	PISTÓN FRENO DE DISCO	851110	TRAS	44.4 mm 1-3/4"	CALIPER DOBLE PISTON	534
	2500	00-02	REP. CIL. MAESTRO Y DE CLUTCH	104459		28.5 mm 1-1/8"		560
	2500	00-06	REPUESTO FRENO DE DISCO	2005	DEL	74.6 mm 2-15/16"	CALIPER DOBLE PISTON	538
	2500	05-06	REPUESTO FRENO DE DISCO	2111	TRAS	44.4 mm 1-3/4"	CALIPER DOBLE PISTON	
	2500	00-04	REPUESTO FRENO DE DISCO	2119	DEL	45.0 mm		540
	2500	00-10	REPUESTO FRENO DE DISCO	2159	TRAS	50.8 mm 2"		540
	2500	07-14	REPUESTO FRENO DE DISCO	21045	DEL	50.8mm 2"		548
		88-91	CILINDRO DE CLUTCH	37815		20.6 mm 13/16"		
		92-98	CILINDRO DE CLUTCH	350182		18.0 mm		
		09-10	CILINDRO MAESTRO	391168		38.1 mm 1-1/2"	EXCEPTO CONTROL DE FRENOS DE REMOLQUE	
		07-08	CILINDRO MAESTRO	391180		37.0 mm	C/C ACTIVO DE FRENOS	
		00-06	KIT DE PISTÓN Y REPUESTO FD	742344	DEL	50.8 mm 2"		
		88-06	KIT DE PISTÓN Y REPUESTO FD	742351	DEL	74.6 mm 2-15/16"		
		00-04	KIT DE PISTÓN Y REPUESTO FD	742369	TRAS	45.0 mm	CON CALIPER DE DOBLE PISTON CUBREPOLVO DURO	
	04-06	KIT DE PISTÓN Y REPUESTO FD	742385	TRAS	44.4 mm 1-3/4"			
	90-98	MANGUERA DE FRENOS	38572	DEL IZQ	23.63"		392	
	89-95	MANGUERA DE FRENOS	38622	DEL IZQ	25.75"		394	
TAHOE		07-14	REPUESTO FRENO DE DISCO	2159	TRAS	50.8 mm 2"		540
		07-14	REPUESTO FRENO DE DISCO	21045	DEL	50.8mm 2"	CALIPER DOBLE PISTON	548
		95-00	CILINDRO DE RUEDA	116359	TRAS IZQ DER	25.4 mm 1"		373

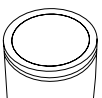



Modelo	Versión	Año	Descripción	Número Lusac	Posición	Diámetro	Notas	Foto Pág.
TAHOE		95-00	CILINDRO DE RUEDA	370189	TRAS IZQ DER	30.1 mm 1-3/16"		380
TIGRA		00-00	CILINDRO MAESTRO	390259		40mm & 1/8"	5.7 LTS	306
		00-02	CILINDRO MAESTRO	390541		34mm	C/BOOSTER DE VACÍO	317
		01-02	CILINDRO MAESTRO	390542		37mm	HYDROBOOSTER	318
		03-06	CILINDRO MAESTRO	390804		34mm	C/C DE TRACCIÓN; C/HYDRO-BOOST	329
		03-03	CILINDRO MAESTRO	390805		1-1/4"	C/C DE TRACCIÓN; BOOSTER DE VACÍO	329
		03-06	CILINDRO MAESTRO	390806		1-1/4"	S/C TRACCIÓN; BOOSTER DE VACÍO	329
		04-06	CILINDRO MAESTRO	390843		34mm	S/C TRACCIÓN; HYDRO-BOOST	331
		07-10	CILINDRO MAESTRO	390986		1-1/4"		338
		07-14	CILINDRO MAESTRO	391172		1-1/4"		346
		00-00	MANGUERA DE FRENOS	38620	IZQ	25.13"	5.7 LTS 4X2	394
		00-00	MANGUERA DE FRENOS	38621	DER	25.13"	5.7 LTS 4X2	394
		00-00	MANGUERA DE FRENOS	38624	CTR	17.75"	5.7 LTS	394
		00-00	MANGUERA DE FRENOS	38664	IZQ	19.5"	5.7 LTS 4X4	395
		00-00	MANGUERA DE FRENOS	38665	DER	19.5"	5.7 LTS 4X4	395
		00-01	MANGUERA DE FRENOS	381380	CTR	16.05"		445
		01-06	MANGUERA DE FRENOS	382412	IZQ	28.38"		464
		01-06	MANGUERA DE FRENOS	382414	DER	27.38"		464
		01-06	MANGUERA DE FRENOS	382610	IZQ	11.56"		476
		03-06	MANGUERA DE FRENOS	382691	CTR	15.5"	CONTROL DE TRACCIÓN	482
		99-99	CILINDRO DE RUEDA	834	DER	19.0 mm 3/4"		364
	99-99	CILINDRO DE RUEDA	834	IZQ	19.0 mm 3/4"		364	
TORNADO		04-11	PISTÓN FRENO DE DISCO	85390	DEL	48.0 mm 1-57/64"		523
		04-11	REPUESTO FRENO DE DISCO	2390	DEL	48.0 mm 1-57/64"		541
		04-08	CILINDRO DE RUEDA	3700916	TRAS DER	22.2 mm 7/8"		384
		04-08	CILINDRO DE RUEDA	3700916	TRAS IZQ	22.2 mm 7/8"		384
		04-11	CILINDRO MAESTRO	39009907		7/8"		361
		04-08	CILINDRO MAESTRO	93305031		23.8 mm 15/16"		361
TRACKER		93-95	MANGUERA DE FRENOS	38616	DEL DER	21.5"		393
		98-99	MANGUERA DE FRENOS	38616	DEL DER	21.5"		393
		93-95	MANGUERA DE FRENOS	38617	DEL IZQ	30.13"		393
		98-99	MANGUERA DE FRENOS	38617	DEL IZQ	30.13"		393
		98-99	MANGUERA DE FRENOS	38618	TRAS IZQ	11.94"		393
		93-95	MANGUERA DE FRENOS	38619	TRAS IZQ	8.5"		
		00-02	MANGUERA DE FRENOS	381622	DEL DER	8.92"		451
		00-02	MANGUERA DE FRENOS	381622	DEL IZQ	8.92"		451
		01-02	MANGUERA DE FRENOS	381622	TRAS IZQ	8.92"		451
		93-95	PISTÓN FRENO DE DISCO	6000	DEL	48.0 mm 1-57/64"		518
		98-08	PISTÓN FRENO DE DISCO	6000	DEL	48.0 mm 1-57/64"		518
		03-08	PISTÓN FRENO DE DISCO	851018	DEL	57.1 mm 2-1/4"		531
		03-08	REPUESTO FRENO DE DISCO	1458	DEL	57.1 mm 2-1/4"		537
	93-95	REPUESTO FRENO DE DISCO	1562	DEL	48.0 mm 1-57/64"		537	
	98-08	REPUESTO FRENO DE DISCO	1562	DEL	48.0 mm 1-57/64"		537	
	93-95	CILINDRO DE RUEDA	37852	DER	15/16"		367	





Modelo	Versión	Año	Descripción	Número Lusac	Posición	Diámetro	Notas	Foto Pág.
CHEVROLET								
TRACKER		93-95	CILINDRO DE RUEDA	37853	IZQ	15/16"		367
		98-98	CILINDRO DE RUEDA	37975	DER	7/8"		369
		98-98	CILINDRO DE RUEDA	37976	IZQ	7/8"		369
		99-08	CILINDRO DE RUEDA	370073	IZQ	7/8"		375
		99-08	CILINDRO DE RUEDA	370074	DER	7/8"		375
		93-95	CILINDRO MAESTRO	39960		7/8"		296
		98-99	CILINDRO MAESTRO	390056		1"	S/ABS	299
		98-99	CILINDRO MAESTRO	390326		15/16"	S/ABS 4 PUERTAS	309
		98-99	CILINDRO MAESTRO	390335		15/16"	C/ABS	309
		07-08	KIT DE PISTÓN Y REPUESTO FD	742303	DEL	57.1 mm 2-1/4"		
		93-95	KIT DE PISTÓN Y REPUESTO FD	742333	DEL	48.0 mm 1-57/64"		
		98-06	KIT DE PISTÓN Y REPUESTO FD	742333	DEL	48.0 mm 1-57/64"		
TRAIL BLAZER		02-07	MANGUERA DE FRENOS	382616	DEL DER	24.88"		477
		02-07	MANGUERA DE FRENOS	382619	TRAS IZQ	13.38"		477
		02-07	PISTÓN FRENO DE DISCO	6000	DEL	48.0 mm 1-57/64"		518
		02-07	PISTÓN FRENO DE DISCO	85119	DEL	45.0 mm		519
		02-06	PISTÓN FRENO DE DISCO	85475	DEL	46.0 mm 1-13/16"	CALIPER DOBLE PISTON	525
		02-06	REPUESTO FRENO DE DISCO	641	TRAS	48.0 mm 1-57/64"		536
		02-07	REPUESTO FRENO DE DISCO	2119	DEL	45.0 mm		540
		02-06	REPUESTO FRENO DE DISCO	2475	DEL	46.0 mm 1-13/16"	CALIPER DOBLE PISTON	541
		02-07	REPUESTO FRENO DE DISCO	21020	TRAS	48.0 mm 1-57/64"		547
	LS, LT	02-06	CILINDRO MAESTRO	390697		1"	4X2	323
		02-06	KIT DE PISTÓN Y REPUESTO FD	742332	TRAS	48.0 mm 1-57/64"	4X2, 4X4	
		02-06	KIT DE PISTÓN Y REPUESTO FD	742369	TRAS	45.0 mm		
UPLANDER		05-09	MANGUERA DE FRENOS	382591	TRAS IZQ	13.5"		475
		05-09	PISTÓN FRENO DE DISCO	85088	DEL	63.5 mm 2-1/2"		519
		05-09	REPUESTO FRENO DE DISCO	99024	DEL	63.5 mm 2-1/2"		553
	LS, LT	05-09	CILINDRO MAESTRO	391010		1"	3.9 LTS, 4X2 EXT, 4X4 EXT	339
VECTRA		03-08	PISTÓN FRENO DE DISCO	851004	DEL	57.1 mm 2-1/4"		530
		03-08	PISTÓN FRENO DE DISCO	851047	DEL	60.0 mm		532
		03-08	REPUESTO FRENO DE DISCO	21004	DEL	57.1 mm 2-1/4"		546
		03-08	REPUESTO FRENO DE DISCO	21047	DEL	60.0 mm		549
		03-08	REPUESTO FRENO DE DISCO	21995	TRAS	54.0 mm 2-1/8"		552
		03-08	CILINDRO MAESTRO	93172089		25.4 mm 1"	2.2 LTS	361
		03-08	KIT DE PISTÓN Y REPUESTO FD	742312	DEL	57.1 mm 2-1/4"	4 L	
		03-07	KIT DE PISTÓN Y REPUESTO FD	742415	DEL	60.0 mm		
VENTURE	APV	97-04	CILINDRO DE RUEDA	37855	DER	23.8 mm 15/16"		367
	APV	97-04	CILINDRO DE RUEDA	37855	IZQ	23.8 mm 15/16"		367
	APV	97-99	CILINDRO MAESTRO	390371		1"	C/ABS	311





Modelo	Versión	Año	Descripción	Número Lusac	Posición	Diámetro	Notas	Foto Pág.
VENTURE	APV	00-04	CILINDRO MAESTRO	390401		1"		312
	APV	98-04	MANGUERA DE FRENOS	380483	TRAS DER	7.75"		422
	APV	98-04	MANGUERA DE FRENOS	380483	TRAS IZQ	7.75"		422
	APV	97-04	MANGUERA DE FRENOS	380581	DEL DER	15.5"		426
	APV	97-04	MANGUERA DE FRENOS	380581	DEL IZQ	15.5"		426
	APV	97-04	MANGUERA DE FRENOS	380913	TRAS IZQ	15.33"		429
	APV	97-04	PISTÓN FRENO DE DISCO	85088	DEL	63.5 mm 2-1/2"		519
	APV	98-04	PISTÓN FRENO DE DISCO	85476	TRAS	38.1 mm 1-1/2"		525
	APV	98-04	REPUESTO FRENO DE DISCO	2476	TRAS	38.1 mm 1-1/2"		
	APV	97-04	REPUESTO FRENO DE DISCO	99024	DEL	63.5 mm 2-1/2"		553
		05-05	CILINDRO DE RUEDA	370190	TRAS IZQ DER	15/16"		381
		05-05	CILINDRO MAESTRO	390401		1"		312
		98-04	KIT DE PISTÓN Y REPUESTO FD	742396	TRAS	38.1 mm 1-1/2"		
		05-05	MANGUERA DE FRENOS	380581	DEL IZQ DER	15.5"		426
		05-05	MANGUERA DE FRENOS	380912	TRAS	7.4"		428
	05-05	MANGUERA DE FRENOS	380913	TRAS	15.33"		429	
ZAFIRA		02-06	PISTÓN FRENO DE DISCO	85391	DEL	57.1 mm 2-1/4"		523
		02-06	REPUESTO FRENO DE DISCO	2472	DEL	57.1 mm 2-1/4"		541
		02-06	CILINDRO DE RUEDA	834	DER	19.0 mm 3/4"		364
		02-06	CILINDRO DE RUEDA	834	IZQ	19.0 mm 3/4"		364
		02-06	CILINDRO MAESTRO	9193225		23.8 mm 15/16"		359
CHRYSLER								
200		12-14	PISTÓN FRENO DE DISCO	851330	DEL	57.1 mm 2-1/4"		534
		12-14	REPUESTO FRENO DE DISCO	21078	DEL	57.1 mm 2-1/4"		550
		11-14	CILINDRO MAESTRO	391144		7/8"		344
		12-14	KIT DE PISTÓN Y REPUESTO FD	742399	DEL	57.1 mm 2-1/4"		
300		10-10	MANGUERA DE FRENOS	382308	DEL DER	19.38"		454
		12-12	MANGUERA DE FRENOS	382308	DEL DER	19.38"		454
		10-10	MANGUERA DE FRENOS	382308	DEL IZQ	19.38"		454
		12-12	MANGUERA DE FRENOS	382308	DEL IZQ	19.38"		454
		10-10	MANGUERA DE FRENOS	382355	TRAS IZQ	18.13"		459
		12-14	MANGUERA DE FRENOS	382355	TRAS IZQ	18.13"		459
		13-14	MANGUERA DE FRENOS	382356	TRAS IZQ	19.13"		459
		10-10	MANGUERA DE FRENOS	382372	DEL DER	25.25"		461
		12-12	MANGUERA DE FRENOS	382372	DEL DER	25.25"		461
		13-14	MANGUERA DE FRENOS	382373	DEL IZQ	25.75"		461
		10-10	MANGUERA DE FRENOS	382375	DEL IZQ	25.38"		461
		12-12	MANGUERA DE FRENOS	382375	DEL IZQ	25.38"		461
		13-14	MANGUERA DE FRENOS	382376	DEL DER	22.13"		461
		05-07	CILINDRO MAESTRO	390977		1"	2.7 LTS C/C DE TRACCIÓN	337
	05-07	CILINDRO MAESTRO	390977		1"	3.5 LTS S/CÓDIGO DE VENTAS XZZ	337	
	05-07	CILINDRO MAESTRO	390978		1"	2.7 LTS S/C TRACCIÓN	337	
	06-07	CILINDRO MAESTRO	390991		1"	2.7 LTS C/C DE TRACCIÓN; CÓDIGO DE VENTAS XZZ	338	





Modelo	Versión	Año	Descripción	Número Lusac	Posición	Diámetro	Notas	Foto Pág.	
CHRYSLER									
300		06-07	CILINDRO MAESTRO	390991		1"	3.5 LTS CÓDIGO DE VENTAS XZZ	338	
		05-09	MANGUERA DE FRENOS	382308	DEL IZQ DER	19.38"	AWD	454	
		05-05	MANGUERA DE FRENOS	382355	IZQ	18.13"	RWD	459	
		11-11	MANGUERA DE FRENOS	382355	IZQ	18.13"	RWD	459	
		05-09	MANGUERA DE FRENOS	382356	IZQ	19.13"	AWD	459	
		05-09	MANGUERA DE FRENOS	382358	DER	19.13"	AWD	459	
		11-11	MANGUERA DE FRENOS	382371	DER	25.81"		461	
		05-09	MANGUERA DE FRENOS	382371	DER	25.81"	RWD	461	
		11-11	MANGUERA DE FRENOS	382374	IZQ	25.75"		461	
300c		05-10	MANGUERA DE FRENOS	382308	DEL DER	19.38"		454	
		05-10	MANGUERA DE FRENOS	382308	DEL IZQ	19.38"		454	
		05-09	MANGUERA DE FRENOS	382355	TRAS IZQ	18.13"		459	
		05-10	MANGUERA DE FRENOS	382356	TRAS IZQ	19.13"		459	
		12-12	MANGUERA DE FRENOS	382356	TRAS IZQ	19.13"		459	
		05-10	MANGUERA DE FRENOS	382358	TRAS DER	19.13"		459	
		12-12	MANGUERA DE FRENOS	382358	TRAS DER	19.13"		459	
		10-10	MANGUERA DE FRENOS	382360	TRAS IZQ	17.38"		460	
		12-12	MANGUERA DE FRENOS	382360	TRAS IZQ	17.38"		460	
		10-10	MANGUERA DE FRENOS	382361	TRAS DER	17.38"		460	
		12-12	MANGUERA DE FRENOS	382361	TRAS DER	17.38"		460	
		05-10	MANGUERA DE FRENOS	382372	DEL DER	25.25"		461	
		12-12	MANGUERA DE FRENOS	382372	DEL DER	25.25"		461	
		05-10	MANGUERA DE FRENOS	382375	DEL IZQ	25.38"		461	
		12-12	MANGUERA DE FRENOS	382375	DEL IZQ	25.38"		461	
		05-09	MANGUERA DE FRENOS	382521	TRAS DER	17.5"		469	
		SRT-8	06-08	CILINDRO MAESTRO	391126		1-1/16"	6.1 LTS	343
		SRT-8	06-08	MANGUERA DE FRENOS	382360	TRAS IZQ	17.38"		460
		SRT-8	06-08	MANGUERA DE FRENOS	382361	TRAS DER	17.38"		460
		SRT-8	06-08	MANGUERA DE FRENOS	382373	DEL IZQ	25.75"		461
		SRT-8	06-08	MANGUERA DE FRENOS	382376	DEL DER	22.13"		461
			05-07	CILINDRO MAESTRO	390977		1"		337
			05-09	CILINDRO MAESTRO	390991		1"	5.7 LTS	338
	300M		99-04	MANGUERA DE FRENOS	381052	TRAS IZQ	13.6"		431
		99-04	MANGUERA DE FRENOS	381053	TRAS DER	13.6"		432	
		99-04	MANGUERA DE FRENOS	381054	DEL IZQ	14.38"		432	
		99-04	MANGUERA DE FRENOS	381055	DEL DER	14.38"		432	
		99-04	PISTÓN FRENO DE DISCO	85163	TRAS	36.1 mm 1-27/64"		520	
		99-04	PISTÓN FRENO DE DISCO	108159	DEL	60.0 mm		528	
		99-04	REPUESTO FRENO DE DISCO	1962	TRAS	36.1 mm 1-27/64"			
		99-04	REPUESTO FRENO DE DISCO	108241	DEL	60.0 mm		554	
		99-04	CILINDRO MAESTRO	390440		15/16"		313	
		01-04	CILINDRO MAESTRO	390719		15/16"		324	
		02-04	CILINDRO MAESTRO	390745		1"		325	
		99-04	KIT DE PISTÓN Y REPUESTO FD	742324	DEL	60.0 mm			
		78-78	KIT DE PISTÓN Y REPUESTO FD	742364	DEL	78.6 mm 3-3/32"			
ASPEN			07-09	MANGUERA DE FRENOS	382363	TRAS DER	22"		460
		07-09	MANGUERA DE FRENOS	382363	TRAS IZQ	22"		460	
		07-09	MANGUERA DE FRENOS	382682	DEL IZQ	32"		481	

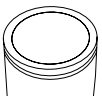



Modelo	Versión	Año	Descripción	Número Lusac	Posición	Diámetro	Notas	Foto Pág.
ASPEN		07-09	MANGUERA DE FRENOS	382683	DEL DER	32"		481
		07-09	PISTÓN FRENO DE DISCO	107534	TRAS	54.0 mm 2-1/8"		528
		07-09	REPUESTO FRENO DE DISCO	2473	TRAS	54.0 mm 2-1/8"		541
		07-09	CILINDRO MAESTRO	391122		1-1/4"		343
		07-09	KIT DE PISTÓN Y REPUESTO FD	742326	TRAS	54.0 mm 2-1/8"	CALIPER SENCILLO	
CIRRUS		96-97	MANGUERA DE FRENOS	380304	TRAS IZQ	14.63"		412
		96-00	MANGUERA DE FRENOS	380305	DEL DER	17.75"		412
		96-00	MANGUERA DE FRENOS	380306	DEL IZQ	18.38"		412
		96-97	MANGUERA DE FRENOS	380309	TRAS DER	16.13"		412
		98-00	MANGUERA DE FRENOS	380977	TRAS DER	22.75"		430
		98-00	MANGUERA DE FRENOS	380978	TRAS IZQ	22.75"		430
		01-05	PISTÓN FRENO DE DISCO	85163	TRAS	36.1 mm 1-27/64"		520
		96-00	PISTÓN FRENO DE DISCO	85469	DEL	54.0 mm 2-1/8"		524
		01-05	PISTÓN FRENO DE DISCO	85470	DEL	60.3 mm 2-3/8"		524
		96-05	PISTÓN FRENO DE DISCO	119043	TRAS	34.9 mm 1-3/8"		529
		01-05	REPUESTO FRENO DE DISCO	1962	TRAS	36.1 mm 1-27/64"		
		01-05	REPUESTO FRENO DE DISCO	2470	DEL	60.3 mm 2-3/8"		
		96-00	REPUESTO FRENO DE DISCO	2845	DEL	54.0 mm 2-1/8"		544
		96-05	REPUESTO FRENO DE DISCO	118265	TRAS	34.1 mm 1-11/32"		554
	CONVERTIBLE	01-05	PISTÓN FRENO DE DISCO	85469	DEL	54.0 mm 2-1/8"		524
	CONVERTIBLE	01-06	PISTÓN FRENO DE DISCO	119043	TRAS	34.9 mm 1-3/8"		529
	CONVERTIBLE	06-06	PISTÓN FRENO DE DISCO	851330	DEL	57.1 mm 2-1/4"		534
	CONVERTIBLE	01-05	REPUESTO FRENO DE DISCO	2845	DEL	54.0 mm 2-1/8"		544
	CONVERTIBLE	06-06	REPUESTO FRENO DE DISCO	21078	DEL	57.1 mm 2-1/4"		550
	CONVERTIBLE	01-06	REPUESTO FRENO DE DISCO	118265	TRAS	34.1 mm 1-11/32"		554
	COUPE	99-00	PISTÓN FRENO DE DISCO	85469	DEL	54.0 mm 2-1/8"		524
	COUPE	99-00	PISTÓN FRENO DE DISCO	119043	TRAS	34.9 mm 1-3/8"		529
	COUPE	99-00	REPUESTO FRENO DE DISCO	2845	DEL	54.0 mm 2-1/8"		544
	COUPE	99-00	REPUESTO FRENO DE DISCO	118265	TRAS	34.1 mm 1-11/32"		554
	TOURING LIMITED	06-08	PISTÓN FRENO DE DISCO	85470	DEL	60.3 mm 2-3/8"		524
	TOURING LIMITED	06-10	PISTÓN FRENO DE DISCO	119043	TRAS	34.9 mm 1-3/8"		529
	TOURING LIMITED	06-10	PISTÓN FRENO DE DISCO	851330	DEL	57.1 mm 2-1/4"		534
TOURING LIMITED	06-08	REPUESTO FRENO DE DISCO	2470	DEL	60.3 mm 2-3/8"			
TOURING LIMITED	06-10	REPUESTO FRENO DE DISCO	21078	DEL	57.1 mm 2-1/4"		550	
TOURING LIMITED	06-10	REPUESTO FRENO DE DISCO	118265	TRAS	34.1 mm 1-11/32"		554	





Modelo	Versión	Año	Descripción	Número Lusac	Posición	Diámetro	Notas	Foto Pág.
CHRYSLER								
CIRRUS		96-00	CILINDRO MAESTRO	390251		7/8"	S/ABS	305
		96-97	CILINDRO MAESTRO	390254		7/8"	C/ABS	305
		98-00	CILINDRO MAESTRO	390425		7/8"	C/ABS	313
		96-05	KIT DE PISTÓN Y REPUESTO FD	742375	DEL	54.0 mm 2-1/8"		
		06-10	KIT DE PISTÓN Y REPUESTO FD	742399	DEL	57.1 mm 2-1/4"		
	96-00	REP. CIL. MAESTRO Y DE CLUTCH	90251			22.2 mm 7/8"		558
CONCORDE		93-97	MANGUERA DE FRENOS	380089	TRAS DER	16.5"		406
		93-97	MANGUERA DE FRENOS	380091	TRAS DER	19.25"		406
		93-97	MANGUERA DE FRENOS	380092	TRAS IZQ	18"		407
		93-97	MANGUERA DE FRENOS	380206	DEL DER	18"		408
		01-02	MANGUERA DE FRENOS	380206	DEL DER	18"		408
		93-97	MANGUERA DE FRENOS	380207	DEL IZQ	21.5"		408
		01-02	MANGUERA DE FRENOS	380207	DEL IZQ	21.5"		408
		01-02	PISTÓN FRENO DE DISCO	85163	TRAS	36.1 mm 1-27/64"		520
		93-97	PISTÓN FRENO DE DISCO	108159	DEL	60.0 mm		528
		01-02	PISTÓN FRENO DE DISCO	108159	DEL	60.0 mm		528
		93-97	PISTÓN FRENO DE DISCO	119043	TRAS	34.9 mm 1-3/8"		529
		01-02	REPUESTO FRENO DE DISCO	1962	TRAS	36.1 mm 1-27/64"		
		93-97	REPUESTO FRENO DE DISCO	108241	DEL	60.0 mm		554
		01-02	REPUESTO FRENO DE DISCO	108241	DEL	60.0 mm		554
		93-97	REPUESTO FRENO DE DISCO	118265	TRAS	34.1 mm 1-11/32"		554
		93-97	CILINDRO MAESTRO	390110		15/16"	S/ABS, S/C DE TRACCIÓN	300
		93-97	CILINDRO MAESTRO	390111		15/16"	C/ABS, C/C DE TRACCIÓN	300
		98-04	CILINDRO MAESTRO	390440		15/16"	EXCEPTO HEAVY DUTY; C/ABS	313
		01-04	CILINDRO MAESTRO	390719		15/16"	S/ABS	324
		02-04	CILINDRO MAESTRO	390745		1"	HEAVY DUTY; C/ABS	325
		93-97	KIT DE PISTÓN Y REPUESTO FD	742324	DEL	60.0 mm		
		01-02	KIT DE PISTÓN Y REPUESTO FD	742324	DEL	60.0 mm		
		98-00	MANGUERA DE FRENOS	381054	IZQ	14.38"		432
		03-04	MANGUERA DE FRENOS	381054	IZQ	14.38"		432
		98-00	MANGUERA DE FRENOS	381055	DER	14.38"		432
	03-04	MANGUERA DE FRENOS	381055	DER	14.38"		432	
CROSSFIRE		04-06	MANGUERA DE FRENOS	381658	DEL DER	16.38"		453
		04-06	MANGUERA DE FRENOS	381658	DEL IZQ	16.38"		453
		04-06	MANGUERA DE FRENOS	381661	TRAS DER	12.13"		453
		04-06	MANGUERA DE FRENOS	381661	TRAS IZQ	12.13"		453
GRAND VOYAGER		91-95	MANGUERA DE FRENOS	380070	TRAS IZQ	17.13"		405
		91-95	MANGUERA DE FRENOS	380071	DEL DER	23"		406
		91-95	MANGUERA DE FRENOS	380072	DEL IZQ	22.75"		406
		96-02	MANGUERA DE FRENOS	380459	TRAS IZQ	17.5"		421
		96-00	MANGUERA DE FRENOS	380460	DEL DER	20.25"		421
		96-00	MANGUERA DE FRENOS	380461	DEL IZQ	20.25"		421

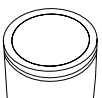

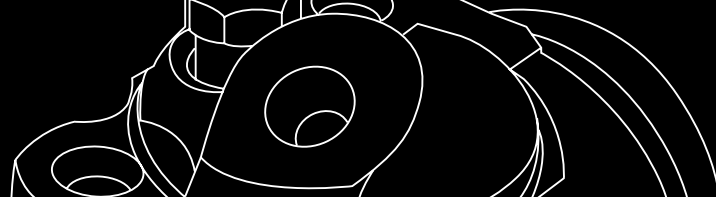

Modelo	Versión	Año	Descripción	Número Lusac	Posición	Diámetro	Notas	Foto Pág.
GRAND VOYAGER		01-02	MANGUERA DE FRENOS	382348	TRAS DER	37"		458
		01-02	MANGUERA DE FRENOS	382350	TRAS DER	35.5"		459
		01-02	MANGUERA DE FRENOS	382366	DEL DER	25.5"		460
		01-02	MANGUERA DE FRENOS	382367	DEL IZQ	25.5"		460
		01-02	PISTÓN FRENO DE DISCO	85152	DEL	64.0 mm		519
		91-00	PISTÓN FRENO DE DISCO	108159	DEL	60.0 mm		528
		01-02	REPUESTO FRENO DE DISCO	2152	DEL	64.0 mm		540
		91-00	REPUESTO FRENO DE DISCO	108241	DEL	60.0 mm		554
		91-00	CILINDRO DE RUEDA	37984	TRAS IZQ DER	17.4 mm 11/16"	2X4 C/ABS CHOCOLATE	369
		91-95	CILINDRO DE RUEDA	109532	DER	19.0 mm 3/4"		372
		91-95	CILINDRO DE RUEDA	109532	IZQ	19.0 mm 3/4"		372
		96-02	CILINDRO DE RUEDA	370027	DER	3/4"		374
		96-02	CILINDRO DE RUEDA	370027	IZQ	3/4"		374
		97-02	CILINDRO DE RUEDA	370051	DER	20.6 mm 13/16"		374
		97-02	CILINDRO DE RUEDA	370051	IZQ	20.6 mm 13/16"		374
		91-95	CILINDRO MAESTRO	108168		24.0 mm	S/ABS	297
		96-96	CILINDRO MAESTRO	390275		15/16"	C/ABS, S/C DE TRACCIÓN	307
		97-00	CILINDRO MAESTRO	390377		15/16"	C/C DE TRACCIÓN	311
		97-00	CILINDRO MAESTRO	390516		1-1/4"	S/C DE TRACCIÓN	316
		97-00	CILINDRO MAESTRO	390534		1"		317
		01-02	CILINDRO MAESTRO	390708		15/16"	DISCO-TAMBOR S/C DE TRACCIÓN	323
		01-02	CILINDRO MAESTRO	390709		1-1/16"	DISCO-DISCO S/C DE TRACCIÓN	323
		01-02	CILINDRO MAESTRO	390710		1-1/16"	DISCO-DISCO C/C DE TRACCIÓN	324
		01-02	CILINDRO MAESTRO	4721565		26.9 mm 1-1/16"	DISCO-DISCO C/C DE TRACCIÓN	359
		91-00	KIT DE PISTÓN Y REPUESTO FD	742324	DEL	60.0 mm		
		01-06	KIT DE PISTÓN Y REPUESTO FD	742371	DEL	64.0 mm		
	91-95	REP. CIL. MAESTRO Y DE CLUTCH	112246		24.0 mm		561	
IMPERIAL		91-91	KIT DE PISTÓN Y REPUESTO FD	742324	DEL	60.0 mm		
LE BARON		92-95	MANGUERA DE FRENOS	38604	TRAS DER	6.88"		392
		92-95	MANGUERA DE FRENOS	38604	TRAS IZQ	6.88"		392
		92-95	MANGUERA DE FRENOS	380073	DEL DER	22.75"		406
		92-95	MANGUERA DE FRENOS	380074	DEL IZQ	22.5"		406
		92-95	PISTÓN FRENO DE DISCO	108159	DEL	60.0 mm		528
		92-95	PISTÓN FRENO DE DISCO	119043	TRAS	34.9 mm 1-3/8"		529
		92-95	REPUESTO FRENO DE DISCO	108241	DEL	60.0 mm		554
		92-95	REPUESTO FRENO DE DISCO	118265	TRAS	34.1 mm 1-11/32"		554
		92-95	CILINDRO MAESTRO	108168		24.0 mm		297
		92-95	KIT DE PISTÓN Y REPUESTO FD	742324	DEL	60.0 mm		
		92-95	REP. CIL. MAESTRO Y DE CLUTCH	112246		24.0 mm		561





Modelo	Versión	Año	Descripción	Número Lusac	Posición	Diámetro	Notas	Foto Pág.	
CHRYSLER									
LE BARON K		83-87	MANGUERA DE FRENOS	4072	DEL DER	21 1/4"		386	
		83-87	MANGUERA DE FRENOS	4073	DEL IZQ	21 1/4"		386	
		83-87	PISTÓN FRENO DE DISCO	107534	DEL	54.0 mm 2-1/8"		528	
		83-87	REPUESTO FRENO DE DISCO	102443	DEL	54.0 mm 2-1/8"		554	
		83-87	CILINDRO DE RUEDA	107475	DER	14.2 mm 9/16"		372	
		83-87	CILINDRO DE RUEDA	107475	IZQ	14.2 mm 9/16"		372	
		83-87	CILINDRO DE RUEDA	107476	DER	15.8 mm 5/8"		372	
		83-87	CILINDRO DE RUEDA	107476	IZQ	15.8 mm 5/8"		372	
		83-87	CILINDRO MAESTRO	108134		21.0 mm		297	
		83-87	KIT DE PISTÓN Y REPUESTO FD	742325	DEL	54.0 mm 2-1/8"	CON CALIPER DE DOBLE PISTON		
	83-87	REPUESTO CILINDRO DE RUEDA	112115		21.0 mm 53/64"		561		
LHS		94-97	KIT DE PISTÓN Y REPUESTO FD	742324	DEL	60.0 mm			
NEON		97-99	CILINDRO DE CLUTCH	39904		19.0 mm 3/4"			
		95-05	KIT DE PISTÓN Y REPUESTO FD	742325	DEL	54.0 mm 2-1/8"	CON CALIPER DE DOBLE PISTON		
		95-95	MANGUERA DE FRENOS	380331	DEL DER	20.75"		414	
NEW YORKER		95-95	MANGUERA DE FRENOS	380332	DEL IZQ	20.75"		414	
		85-89	MANGUERA DE FRENOS	4072	DEL DER	21 1/4"		386	
		85-89	MANGUERA DE FRENOS	4073	DEL IZQ	21 1/4"		386	
		85-89	MANGUERA DE FRENOS	38064	TRAS IZQ	8.25"		388	
		90-94	MANGUERA DE FRENOS	38604	TRAS DER	6.88"		392	
		90-94	MANGUERA DE FRENOS	38604	TRAS IZQ	6.88"		392	
		90-94	MANGUERA DE FRENOS	380073	DEL DER	22.75"		406	
		90-94	MANGUERA DE FRENOS	380074	DEL IZQ	22.5"		406	
		94-97	MANGUERA DE FRENOS	380089	TRAS DER	16.5"		406	
		94-97	MANGUERA DE FRENOS	380206	DEL DER	18"		408	
		94-97	MANGUERA DE FRENOS	380207	DEL IZQ	21.5"		408	
		85-89	PISTÓN FRENO DE DISCO	107534	DEL	54.0 mm 2-1/8"		528	
		90-97	PISTÓN FRENO DE DISCO	108159	DEL	60.0 mm		528	
		90-97	PISTÓN FRENO DE DISCO	119043	TRAS	34.9 mm 1-3/8"		529	
		85-89	REPUESTO FRENO DE DISCO	102443	DEL	54.0 mm 2-1/8"		554	
		90-97	REPUESTO FRENO DE DISCO	108241	DEL	60.0 mm		554	
		90-97	REPUESTO FRENO DE DISCO	118265	TRAS	34.1 mm 1-11/32"		554	
	LH, LHS		94-97	CILINDRO MAESTRO	390110		15/16"	S/ABS	300
	LH, LHS		94-97	CILINDRO MAESTRO	390111		15/16"	C/ABS	300
			85-89	CILINDRO DE RUEDA	107475	DER	14.2 mm 9/16"		372
			85-89	CILINDRO DE RUEDA	107475	IZQ	14.2 mm 9/16"		372
			85-89	CILINDRO DE RUEDA	107476	DER	15.8 mm 5/8"		372
			85-89	CILINDRO DE RUEDA	107476	IZQ	15.8 mm 5/8"		372
			85-89	CILINDRO MAESTRO	108134		21.0 mm		297
			90-94	CILINDRO MAESTRO	108168		24.0 mm		297
			90-97	KIT DE PISTÓN Y REPUESTO FD	742324	DEL	60.0 mm		
NEW YORKER		85-89	KIT DE PISTÓN Y REPUESTO FD	742325	DEL	54.0 mm 2-1/8"	CON CALIPER DE DOBLE PISTON		
		90-94	REP. CIL. MAESTRO Y DE CLUTCH	112246		24.0 mm		561	

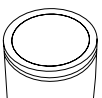



Modelo	Versión	Año	Descripción	Número Lusac	Posición	Diámetro	Notas	Foto Pág.
NEW YORKER		85-89	REPUESTO CILINDRO DE RUEDA	112115		21.0 mm 53/64"		561
		93-95	REPUESTO CILINDRO DE RUEDA	128251		15.8 mm 5/8"		
PACIFICA		04-06	MANGUERA DE FRENOS	382362	TRAS IZQ	19.62"		460
		04-06	MANGUERA DE FRENOS	382368	TRAS DER	18.75"		460
		04-06	MANGUERA DE FRENOS	382518	DEL IZQ	24.25"		468
	TOURING	07-08	MANGUERA DE FRENOS	382362	TRAS IZQ	19.62"		460
	TOURING	07-08	MANGUERA DE FRENOS	382368	TRAS DER	18.75"		460
	TOURING	07-08	MANGUERA DE FRENOS	382518	DEL IZQ	24.25"		468
		04-06	CILINDRO MAESTRO	390788		1"	S/C DE TRACCIÓN	328
PHANTOM		87-89	MANGUERA DE FRENOS	4072	DEL DER	21 1/4"		386
		87-89	MANGUERA DE FRENOS	4073	DEL IZQ	21 1/4"		386
		87-89	MANGUERA DE FRENOS	38064	TRAS IZQ	8.25"		388
		90-94	MANGUERA DE FRENOS	38604	TRAS DER	6.88"		392
		90-94	MANGUERA DE FRENOS	38604	TRAS IZQ	6.88"		392
		90-94	MANGUERA DE FRENOS	380073	DEL DER	22.75"		406
		90-94	MANGUERA DE FRENOS	380074	DEL IZQ	22.5"		406
		87-89	PISTÓN FRENO DE DISCO	107534	DEL	54.0 mm 2-1/8"		528
		90-94	PISTÓN FRENO DE DISCO	108159	DEL	60.0 mm		528
		90-94	PISTÓN FRENO DE DISCO	119043	TRAS	34.9 mm 1-3/8"		529
		87-89	REPUESTO FRENO DE DISCO	102443	DEL	54.0 mm 2-1/8"		554
		90-94	REPUESTO FRENO DE DISCO	108241	DEL	60.0 mm		554
		90-94	REPUESTO FRENO DE DISCO	118265	TRAS	34.1 mm 1-11/32"		554
		87-89	CILINDRO DE RUEDA	107475	DER	14.2 mm 9/16"		372
		87-89	CILINDRO DE RUEDA	107475	IZQ	14.2 mm 9/16"		372
		87-89	CILINDRO DE RUEDA	107476	DER	15.8 mm 5/8"		372
		87-89	CILINDRO DE RUEDA	107476	IZQ	15.8 mm 5/8"		372
		87-89	CILINDRO MAESTRO	108134		21.0 mm		297
		90-94	CILINDRO MAESTRO	108168		24.0 mm		297
		90-94	KIT DE PISTÓN Y REPUESTO FD	742324	DEL	60.0 mm		
		87-89	KIT DE PISTÓN Y REPUESTO FD	742325	DEL	54.0 mm 2-1/8"	CON CALIPER DE DOBLE PISTON	
		90-94	REP. CIL. MAESTRO Y DE CLUTCH	112246		24.0 mm		561
	87-89	REPUESTO CILINDRO DE RUEDA	112115		21.0 mm 53/64"		561	
PT CRUISER		01-10	MANGUERA DE FRENOS	382306	DEL IZQ	17.5"		454
		01-10	MANGUERA DE FRENOS	382307	DEL DER	17.5"		454
		01-10	MANGUERA DE FRENOS	382312	DEL DER	17.75"		455
		01-10	MANGUERA DE FRENOS	382313	DEL IZQ	17.75"		455
		01-03	MANGUERA DE FRENOS	382314	TRAS DER	9.86"		455
		01-10	MANGUERA DE FRENOS	382315	TRAS IZQ	14.32"		455
		01-10	MANGUERA DE FRENOS	382316	TRAS DER	11.32"		455
		01-03	MANGUERA DE FRENOS	382317	TRAS IZQ	9.86"		455
		04-06	MANGUERA DE FRENOS	382389	DEL DER	21.63"		462
		04-10	MANGUERA DE FRENOS	382389	TRAS DER	21.63"		462
		04-06	MANGUERA DE FRENOS	382390	DEL IZQ	21.63"		463
		04-10	MANGUERA DE FRENOS	382390	TRAS IZQ	21.63"		463
		01-10	PISTÓN FRENO DE DISCO	85029	DEL	57.1 mm 2-1/4"		519





Modelo	Versión	Año	Descripción	Número Lusac	Posición	Diámetro	Notas	Foto Pág.
CHRYSLER								
PT CRUISER		01-10	PISTÓN FRENO DE DISCO	85163	TRAS	36.1 mm 1-27/64"		520
		01-10	REPUESTO FRENO DE DISCO	1962	TRAS	36.1 mm 1-27/64"		
		01-10	REPUESTO FRENO DE DISCO	2029	DEL	57.1 mm 2-1/4"		
	CONVERTIBLE	03-05	CILINDRO MAESTRO	390577		15/16"	C/ABS	319
	CONVERTIBLE	06-08	CILINDRO MAESTRO	391031		7/8"	DISCO-DISCO	340
	CONVERTIBLE	03-05	CILINDRO MAESTRO	5015160		23.8 mm 15/16"	DISCO-DISCO C/ABS	359
	CONVERTIBLE	03-08	MANGUERA DE FRENOS	382306	DEL IZQ	17.5"		454
	CONVERTIBLE	03-08	MANGUERA DE FRENOS	382307	DEL DER	17.5"		454
	CONVERTIBLE	03-08	MANGUERA DE FRENOS	382315	TRAS IZQ	14.32"		455
	CONVERTIBLE	03-08	MANGUERA DE FRENOS	382316	TRAS DER	11.32"		455
	CONVERTIBLE	03-08	PISTÓN FRENO DE DISCO	85029	DEL	57.1 mm 2-1/4"		519
	CONVERTIBLE	03-08	PISTÓN FRENO DE DISCO	85163	TRAS	36.1 mm 1-27/64"		520
	CONVERTIBLE	03-08	REPUESTO FRENO DE DISCO	1962	TRAS	36.1 mm 1-27/64"		
	CONVERTIBLE	03-08	REPUESTO FRENO DE DISCO	2029	DEL	57.1 mm 2-1/4"		
	TURBO	03-05	CILINDRO MAESTRO	390577		15/16"	C/ABS	319
	TURBO	06-07	CILINDRO MAESTRO	391031		7/8"		340
	TURBO	03-05	CILINDRO MAESTRO	5015160		23.8 mm 15/16"	DISCO-DISCO C/ABS	359
	TURBO	03-07	MANGUERA DE FRENOS	382306	DEL IZQ	17.5"		454
	TURBO	03-07	MANGUERA DE FRENOS	382307	DEL DER	17.5"		454
	TURBO	03-05	MANGUERA DE FRENOS	382312	DEL DER	17.75"		455
	TURBO	03-05	MANGUERA DE FRENOS	382313	DEL IZQ	17.75"		455
	TURBO	03-05	MANGUERA DE FRENOS	382314	TRAS DER	9.86"		455
	TURBO	03-07	MANGUERA DE FRENOS	382315	TRAS IZQ	14.32"		455
	TURBO	03-07	MANGUERA DE FRENOS	382316	TRAS DER	11.32"		455
	TURBO	03-05	MANGUERA DE FRENOS	382317	TRAS IZQ	9.86"		455
	TURBO	03-07	PISTÓN FRENO DE DISCO	85029	DEL	57.1 mm 2-1/4"		519
	TURBO	03-07	PISTÓN FRENO DE DISCO	85163	TRAS	36.1 mm 1-27/64"		520
	TURBO	03-07	REPUESTO FRENO DE DISCO	1962	TRAS	36.1 mm 1-27/64"		
	TURBO	03-07	REPUESTO FRENO DE DISCO	2029	DEL	57.1 mm 2-1/4"		
		01-06	CILINDRO DE RUEDA	109532	DER	19.0 mm 3/4"		372
		01-06	CILINDRO DE RUEDA	109532	IZQ	19.0 mm 3/4"		372
		04-10	CILINDRO DE RUEDA	370176	DER	13/16"		379
	04-10	CILINDRO DE RUEDA	370176	IZQ	13/16"		379	
	01-03	CILINDRO DE RUEDA	370195	DER	3/4"		381	
	01-03	CILINDRO DE RUEDA	370195	IZQ	3/4"		381	
	01-05	CILINDRO MAESTRO	390577		15/16"	C/ABS	319	
	01-05	CILINDRO MAESTRO	390638		15/16"	S/ABS	321	
	04-04	CILINDRO MAESTRO	391030		15/16"	S/ABS	340	
	06-10	CILINDRO MAESTRO	391031		7/8"	DISCO-DISCO	340	
	01-05	CILINDRO MAESTRO	5015160		23.8 mm 15/16"	DISCO-DISCO C/ABS	359	
	01-05	CILINDRO MAESTRO	5017973		23.8 mm 15/16"	S/ABS	359	
SEBRING	R/T	97-97	CILINDRO MAESTRO	390251		7/8"	S/ABS	305
	R/T	97-97	CILINDRO MAESTRO	390254		7/8"	C/ABS	305
	R/T	97-97	MANGUERA DE FRENOS	380304	TRAS IZQ	14.63"		412
	R/T	97-97	MANGUERA DE FRENOS	380309	TRAS DER	16.13"		412

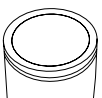



Modelo	Versión	Año	Descripción	Número Lusac	Posición	Diámetro	Notas	Foto Pág.
STRATUS	R/T	97-97	MANGUERA DE FRENOS	380532	DEL IZQ	18.5"		424
	R/T	97-97	MANGUERA DE FRENOS	380579	DEL DER	16"		426
	R/T	97-97	PISTÓN FRENO DE DISCO	85469	DEL	54.0 mm 2-1/8"		524
	R/T	97-97	PISTÓN FRENO DE DISCO	119043	TRAS	34.9 mm 1-3/8"		529
	R/T	97-97	REP. CIL. MAESTRO Y DE CLUTCH	90251		22.2 mm 7/8"		558
	R/T	97-97	REPUESTO FRENO DE DISCO	2845	DEL	54.0 mm 2-1/8"		544
	R/T	97-97	REPUESTO FRENO DE DISCO	118265	TRAS	34.1 mm 1-11/32"		554
		97-97	CILINDRO DE CLUTCH	350087		15.8 mm 5/8"	NACIONAL	
		01-02	CILINDRO DE CLUTCH	519868		15.8 mm 5/8"	CHOCOLATE	
		01-05	CILINDRO DE RUEDA	37376	TRAS IZQ DER	3/4"	2 PTAS CONVERTIBLE	365
		96-00	CILINDRO DE RUEDA	107476	TRAS IZQ DER	15.8 mm 5/8"	2 PTAS CONVERTIBLE	372
		07-09	CILINDRO DE RUEDA	370197	TRAS IZQ DER	13/16"		381
		96-96	CILINDRO MAESTRO	390251		7/8"	2 PTAS CONVERTIBLE S/ABS	305
		98-00	CILINDRO MAESTRO	390251		7/8"	2 PTAS CONVERTIBLE S/ABS	305
		98-00	CILINDRO MAESTRO	390425		7/8"	2 PTAS CONVERTIBLE C/ABS	313
		01-05	CILINDRO MAESTRO	390660		1-1/16"	2 PTAS COUPE C/ABS; S/C DE TRACCIÓN	322
		01-05	CILINDRO MAESTRO	390661		1-1/16"	2 PTAS COUPE S/ABS; S/C TRACCIÓN	322
		03-06	CILINDRO MAESTRO	390816		15/16"	DISCO-TAMBOR	330
		07-09	CILINDRO MAESTRO	391142		7/8"	DISCO-TAMBOR	344
		07-10	CILINDRO MAESTRO	391144		7/8"		344
		97-97	KIT DE PISTÓN Y REPUESTO FD	742375	DEL	54.0 mm 2-1/8"		
		00-05	MANGUERA DE FRENOS	38328	TRAS IZQ DER	10.5"	DISCO-DISCO 2 PTAS COUPE	390
		00-00	MANGUERA DE FRENOS	380307	DER	18.38"	DISCO-TAMBOR 2 PTAS CONVERTIBLE	412
		96-96	MANGUERA DE FRENOS	380308	IZQ	14.13"	DISCO-TAMBOR 2 PTAS CONVERTIBLE	412
		98-00	MANGUERA DE FRENOS	380308	IZQ	14.13"	DISCO-TAMBOR 2 PTAS CONVERTIBLE	412
		96-96	MANGUERA DE FRENOS	380532	DER	18.5"	2 PTAS CONVERTIBLE	424
		98-00	MANGUERA DE FRENOS	380532	DER	18.5"	2 PTAS CONVERTIBLE	424
		95-96	MANGUERA DE FRENOS	380545	DEL IZQ DER	22.25"	2 PTAS COUPE	425
		98-00	MANGUERA DE FRENOS	380545	DEL IZQ DER	22.25"	2 PTAS COUPE	425
		96-96	MANGUERA DE FRENOS	380579	IZQ	16"	2 PTAS CONVERTIBLE	426
		98-00	MANGUERA DE FRENOS	380579	IZQ	16"	2 PTAS CONVERTIBLE	426
		03-06	MANGUERA DE FRENOS	382351	DER	14.75"	DISCO-TAMBOR	459
		03-06	MANGUERA DE FRENOS	382352	IZQ	14.75"	DISCO-TAMBOR	459
	01-02	CILINDRO DE CLUTCH	519868		15.8 mm 5/8"	NACIONAL		
TOWN & COUNTRY		02-06	CILINDRO MAESTRO	390720		25.4 mm 1"	Disco_Disco 4 PTAS SEDAN	324
		95-00	KIT DE PISTÓN Y REPUESTO FD	742375	DEL	54.0 mm 2-1/8"		





Modelo	Versión	Año	Descripción	Número Lusac	Posición	Diámetro	Notas	Foto Pág.
CHRYSLER								
TOWN & COUNTRY		95-00	MANGUERA DE FRENOS	380975	TRAS DER	17"	C/ABS FRENO DE TAMBOR	430
		95-00	MANGUERA DE FRENOS	380976	TRAS IZQ	17.75"	C/ABS FRENO DE TAMBOR	430
		94-95	MANGUERA DE FRENOS	38646	TRAS IZQ	9.38"		395
		93-93	MANGUERA DE FRENOS	380070	TRAS IZQ	17.13"		405
		93-95	MANGUERA DE FRENOS	380071	DEL DER	23"		406
		93-95	MANGUERA DE FRENOS	380072	DEL IZQ	22.75"		406
		97-00	MANGUERA DE FRENOS	380459	TRAS DER	17.5"		421
		96-00	MANGUERA DE FRENOS	380459	TRAS IZQ	17.5"		421
		96-00	MANGUERA DE FRENOS	380460	DEL DER	20.25"		421
		97-00	MANGUERA DE FRENOS	380460	TRAS DER	20.25"		421
		96-00	MANGUERA DE FRENOS	380461	DEL IZQ	20.25"		421
		97-00	MANGUERA DE FRENOS	380461	TRAS IZQ	20.25"		421
		01-07	MANGUERA DE FRENOS	382339	TRAS IZQ	55.5"		458
		05-06	MANGUERA DE FRENOS	382342	TRAS DER	37.38"		458
		05-06	MANGUERA DE FRENOS	382344	TRAS IZQ	37.38"		458
		01-04	MANGUERA DE FRENOS	382345	TRAS IZQ	55.5"		458
		01-04	MANGUERA DE FRENOS	382346	TRAS IZQ	33.5"		458
		01-07	MANGUERA DE FRENOS	382347	TRAS DER	37"		458
		01-04	MANGUERA DE FRENOS	382348	TRAS DER	37"		458
		01-04	MANGUERA DE FRENOS	382350	TRAS DER	35.5"		459
		01-07	MANGUERA DE FRENOS	382366	DEL IZQ	25.5"		460
		01-06	MANGUERA DE FRENOS	382366	TRAS IZQ	25.5"		460
		01-07	MANGUERA DE FRENOS	382367	DEL DER	25.5"		460
		01-06	MANGUERA DE FRENOS	382367	TRAS DER	25.5"		460
		08-12	MANGUERA DE FRENOS	382519	DEL DER	17.5"		469
		08-12	MANGUERA DE FRENOS	382520	DEL IZQ	17.5"		469
		08-09	MANGUERA DE FRENOS	382521	TRAS IZQ	17.5"		469
		08-09	MANGUERA DE FRENOS	382522	TRAS DER	17.5"		469
		01-07	PISTÓN FRENO DE DISCO	85152	DEL	64.0 mm		519
		08-12	PISTÓN FRENO DE DISCO	85153	DEL	66.0 mm		519
		01-07	PISTÓN FRENO DE DISCO	85392	DEL	66.0 mm		523
		93-00	PISTÓN FRENO DE DISCO	108159	DEL	60.0 mm		528
		01-07	REPUESTO FRENO DE DISCO	2152	DEL	64.0 mm		540
		01-07	REPUESTO FRENO DE DISCO	21080	DEL	66.0 mm		550
		08-12	REPUESTO FRENO DE DISCO	21998	DEL	66.0 mm		552
		93-00	REPUESTO FRENO DE DISCO	108241	DEL	60.0 mm		554
		96-96	CILINDRO DE RUEDA	37863	DER	3/4"		368
	96-96	CILINDRO DE RUEDA	37863	IZQ	3/4"		368	
	93-95	CILINDRO DE RUEDA	109532	DER	19.0 mm 3/4"		372	
	93-95	CILINDRO DE RUEDA	109532	IZQ	19.0 mm 3/4"		372	
	97-00	CILINDRO DE RUEDA	370027	DER	3/4"		374	
	97-00	CILINDRO DE RUEDA	370027	IZQ	3/4"		374	
	97-07	CILINDRO DE RUEDA	370051	DER	20.6 mm 13/16"		374	
	97-07	CILINDRO DE RUEDA	370051	IZQ	20.6 mm 13/16"		374	
VOLARE		93-95	CILINDRO MAESTRO	108168		24.0 mm	SIST. INT. C/ ABS, BENDIX	297

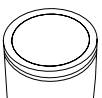



Modelo	Versión	Año	Descripción	Número Lusac	Posición	Diámetro	Notas	Foto Pág.
VOYAGER		96-96	CILINDRO MAESTRO	390275		15/16"	S/C DE TRACCIÓN	307
		96-00	CILINDRO MAESTRO	390377		15/16"	C/C DE TRACCIÓN	311
		97-00	CILINDRO MAESTRO	390516		1-1/4"	S/C DE TRACCIÓN	316
		97-00	CILINDRO MAESTRO	390534		1"	C/C DE TRACCIÓN	317
		01-07	CILINDRO MAESTRO	390708		15/16"	DISCO-TAMBOR S/C DE TRACCIÓN	323
		01-02	CILINDRO MAESTRO	390709		1-1/16"	DISCO-DISCO S/C DE TRACCIÓN	323
		01-06	CILINDRO MAESTRO	390710		1-1/16"	C/C DE TRACCIÓN	324
		03-07	CILINDRO MAESTRO	390788		1"		328
		05-07	CILINDRO MAESTRO	390975		15/16"	DISCO-TAMBOR C/ABS	337
		01-04	CILINDRO MAESTRO	4721565		26.9 mm 1-1/16"	DISCO-DISCO C/C DE TRACCIÓN	359
		93-00	KIT DE PISTÓN Y REPUESTO FD	742324	DEL	60.0 mm		
		01-07	KIT DE PISTÓN Y REPUESTO FD	742346	DEL	66.0 mm		
		01-07	KIT DE PISTÓN Y REPUESTO FD	742371	DEL	64.0 mm		
		08-10	KIT DE PISTÓN Y REPUESTO FD	742424	DEL	66.0 mm	NACIONAL	
		97-00	REP. CIL. MAESTRO Y DE CLUTCH	90516		31.7 mm 1-1/4"		559
		93-95	REP. CIL. MAESTRO Y DE CLUTCH	112246		24.0 mm		561
		82-88	KIT DE PISTÓN Y REPUESTO FD	742325	DEL	54.0 mm 2-1/8"	CON CALIPER DE DOBLE PISTON	
		94-95	MANGUERA DE FRENOS	38646	TRAS DER	9.38"		395
		94-95	MANGUERA DE FRENOS	38646	TRAS IZQ	9.38"		395
		94-00	MANGUERA DE FRENOS	380070	TRAS DER	17.13"		405
		94-00	MANGUERA DE FRENOS	380070	TRAS IZQ	17.13"		405
		94-95	MANGUERA DE FRENOS	380071	DEL DER	23"		406
		94-95	MANGUERA DE FRENOS	380072	DEL IZQ	22.75"		406
		94-95	MANGUERA DE FRENOS	380073	DEL DER	22.75"		406
		94-95	MANGUERA DE FRENOS	380074	DEL IZQ	22.5"		406
		96-96	MANGUERA DE FRENOS	380459	TRAS DER	17.5"		421
		01-02	MANGUERA DE FRENOS	380459	TRAS DER	17.5"		421
		96-96	MANGUERA DE FRENOS	380459	TRAS IZQ	17.5"		421
		01-02	MANGUERA DE FRENOS	380459	TRAS IZQ	17.5"		421
		96-00	MANGUERA DE FRENOS	380460	DEL DER	20.25"		421
		96-00	MANGUERA DE FRENOS	380461	DEL IZQ	20.25"		421
		01-04	MANGUERA DE FRENOS	382348	TRAS DER	37"		458
		01-08	MANGUERA DE FRENOS	382366	DEL DER	25.5"		460
		01-08	MANGUERA DE FRENOS	382367	DEL IZQ	25.5"		460
		09-12	MANGUERA DE FRENOS	382519	DEL DER	17.5"		469
		09-12	MANGUERA DE FRENOS	382520	DEL IZQ	17.5"		469
		07-10	MANGUERA DE FRENOS	382521	TRAS IZQ	17.5"		469
		07-10	MANGUERA DE FRENOS	382522	TRAS DER	17.5"		469
		01-08	PISTÓN FRENO DE DISCO	85152	DEL	64.0 mm		519
		09-12	PISTÓN FRENO DE DISCO	85153	DEL	66.0 mm		519
		01-08	PISTÓN FRENO DE DISCO	85392	DEL	66.0 mm		523
		94-00	PISTÓN FRENO DE DISCO	108159	DEL	60.0 mm		528





Modelo	Versión	Año	Descripción	Número Lusac	Posición	Diámetro	Notas	Foto Pág.
CHRYSLER								
VOYAGER		01-08	PISTÓN FRENO DE DISCO	850020	TRAS	42.0 mm		529
		01-08	REPUESTO FRENO DE DISCO	2152	DEL	64.0 mm		540
		01-08	REPUESTO FRENO DE DISCO	20020	TRAS	42.0 mm		545
		01-08	REPUESTO FRENO DE DISCO	21080	DEL	66.0 mm		550
		09-12	REPUESTO FRENO DE DISCO	21998	DEL	66.0 mm		552
		94-00	REPUESTO FRENO DE DISCO	108241	DEL	60.0 mm		554
		94-95	CILINDRO DE RUEDA	109532	DER	19.0 mm 3/4"		372
		94-95	CILINDRO DE RUEDA	109532	IZQ	19.0 mm 3/4"		372
		96-00	CILINDRO DE RUEDA	370027	DER	3/4"		374
		96-00	CILINDRO DE RUEDA	370027	IZQ	3/4"		374
		97-06	CILINDRO DE RUEDA	370051	DER	20.6 mm 13/16"		374
		97-06	CILINDRO DE RUEDA	370051	IZQ	20.6 mm 13/16"		374
		94-95	CILINDRO MAESTRO	108168		24.0 mm		297
		96-00	CILINDRO MAESTRO	390275		15/16"		307
		97-00	CILINDRO MAESTRO	390377		15/16"	CON CONTR. DE TRACCIÓN	311
		97-00	CILINDRO MAESTRO	390516		1-1/4"		316
		97-00	CILINDRO MAESTRO	390534		1"	S/C DE TRACCIÓN	317
		01-08	CILINDRO MAESTRO	390708		15/16"		323
		01-04	CILINDRO MAESTRO	390709		1-1/16"		323
		01-02	CILINDRO MAESTRO	390710		1-1/16"		324
		94-00	KIT DE PISTÓN Y REPUESTO FD	742324	DEL	60.0 mm		
		01-08	KIT DE PISTÓN Y REPUESTO FD	742346	DEL	66.0 mm	DISCO DISCO NACIONAL	
	01-07	KIT DE PISTÓN Y REPUESTO FD	742371	DEL	64.0 mm	DISCO TAMBOR		
	87-91	MANGUERA DE FRENOS	38605	TRAS	17.25"	CHOCOLATE	392	
	01-04	REP. CIL. MAESTRO Y DE CLUTCH	90707		26.9 mm 1-1/16"		559	
	94-95	REP. CIL. MAESTRO Y DE CLUTCH	112246		24.0 mm		561	
DAEWOO								
LANOS		99-02	MANGUERA DE FRENOS	38657	DEL IZQ DER	13.75"		395
DINA								
D3000		75-77	KIT DE PISTÓN Y REPUESTO FD	742365	DEL	85.7 mm 3-3/8"		
D3200		75-77	KIT DE PISTÓN Y REPUESTO FD	742365	DEL	85.7 mm 3-3/8"		
DODGE								
2000GTX		89-92	CILINDRO DE RUEDA	37969	TRAS IZQ DER	19.0 mm 3/4"	CHOCOLATE	369
ATOS		01-12	PISTÓN FRENO DE DISCO	2724	DEL	50.8 mm 2"		517
		01-12	REPUESTO FRENO DE DISCO	2725	DEL	50.8 mm 2"		542
		01-12	CILINDRO DE RUEDA	370018RL	DER	17.8 mm 45/64"		
		01-12	CILINDRO DE RUEDA	370018RL	IZQ	17.8 mm 45/64"		
		01-07	CILINDRO MAESTRO	05069615		20.6 mm 13/16"	PISTON SEC.SIN RANURADO	359
		01-07	CILINDRO MAESTRO	5083353		20.6 mm 13/16"	1/2" REP.P. SEC. RANURADO	359
	01-03	REP. CIL. MAESTRO Y DE CLUTCH	2720		20.6 mm 13/16"			

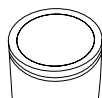

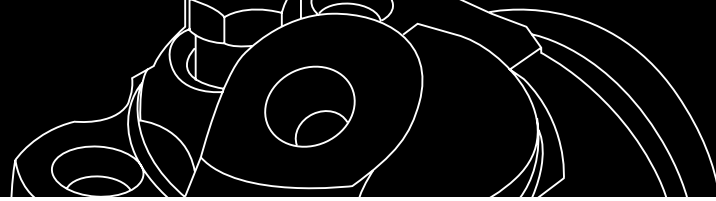

Modelo	Versión	Año	Descripción	Número Lusac	Posición	Diámetro	Notas	Foto Pág.
ATOS		01-07	REP. CIL. MAESTRO Y DE CLUTCH	2726		20.6 mm 13/16"		557
ATTITUDE		06-11	PISTÓN FRENO DE DISCO	851067	DEL	54.0 mm 2-1/8"		533
		06-11	REPUESTO FRENO DE DISCO	21067	DEL	54.0 mm 2-1/8"		550
	GL, GLS	06-11	CILINDRO DE RUEDA	370194	IZQ	11/16"		381
	GL, GLS	06-08	CILINDRO DE RUEDA	370018RL	DER	17.8 mm 45/64"		
	GL, GLS	06-08	CILINDRO DE RUEDA	370018RL	IZQ	17.8 mm 45/64"		
	GL, GLS	06-11	CILINDRO MAESTRO	391022		7/8"	S/ABS	339
	GL, GLS	06-11	CILINDRO MAESTRO	391024		7/8"	C/ABS	340
		07-07	CILINDRO DE RUEDA	3700922	TRAS IZQ DER	22.2 mm 7/8"	FABRICADO EN MÉXICO	
AVENGER		08-14	PISTÓN FRENO DE DISCO	851330	DEL	57.1 mm 2-1/4"		534
		08-14	REPUESTO FRENO DE DISCO	21078	DEL	57.1 mm 2-1/4"		550
	SE, SXT SPORT	08-10	CILINDRO DE RUEDA	370197	IZQ	13/16"		381
	SE, SXT SPORT	08-12	CILINDRO MAESTRO	391142		7/8"	DISCO-TAMBOR	344
	SE, SXT SPORT	08-14	CILINDRO MAESTRO	391144		7/8"	DISCO-DISCO	344
		95-99	CILINDRO DE CLUTCH	350087		15.8 mm 5/8"		
		08-14	KIT DE PISTÓN Y REPUESTO FD	742399	DEL	57.1 mm 2-1/4"		
		95-00	MANGUERA DE FRENOS	38328	TRAS IZQ DER	10.5"	DISCO-DISCO	390
	95-00	MANGUERA DE FRENOS	380545	DEL IZQ DER	22.25"		425	
B100		92-93	CILINDRO DE CLUTCH	360046	INF	25.4 mm 1"		
B150		87-87	MANGUERA DE FRENOS	38605	TRAS	17.25"		392
B250		87-87	MANGUERA DE FRENOS	38605	TRAS	17.25"		392
B350		87-87	MANGUERA DE FRENOS	38605	TRAS	17.25"		392
BREEZE		96-96	MANGUERA DE FRENOS	380305	DEL DER	17.75"		412
		96-96	MANGUERA DE FRENOS	380306	DEL IZQ	18.38"		412
		96-96	MANGUERA DE FRENOS	380307	TRAS DER	18.38"		412
		96-96	MANGUERA DE FRENOS	380308	TRAS IZQ	14.13"		412
		96-96	PISTÓN FRENO DE DISCO	85469	DEL	54.0 mm 2-1/8"		524
		96-96	REPUESTO FRENO DE DISCO	2845	DEL	54.0 mm 2-1/8"		544
		96-96	CILINDRO DE RUEDA	37970	DER	3/4"		369
		96-96	CILINDRO DE RUEDA	37970	IZQ	3/4"		369
		96-96	CILINDRO MAESTRO	390251		7/8"		305
		96-96	REP. CIL. MAESTRO Y DE CLUTCH	90251		22.2 mm 7/8"		558
CALIBER		07-12	PISTÓN FRENO DE DISCO	851330	DEL	57.1 mm 2-1/4"		534
		07-12	REPUESTO FRENO DE DISCO	21078	DEL	57.1 mm 2-1/4"		550
	SRT-4	08-09	CILINDRO MAESTRO	391143		15/16"	2.4 LTS	344
	SRT-4	08-09	PISTÓN FRENO DE DISCO	851330	DEL	57.1 mm 2-1/4"		534
	SRT-4	08-09	REPUESTO FRENO DE DISCO	21078	DEL	57.1 mm 2-1/4"		550
		07-12	CILINDRO DE RUEDA	370197	DER	13/16"		381
		07-12	CILINDRO DE RUEDA	370197	IZQ	13/16"		381
		07-12	CILINDRO MAESTRO	391066		13/16"	C/ABS	341
	07-12	KIT DE PISTÓN Y REPUESTO FD	742399	DEL	57.1 mm 2-1/4"			





Modelo	Versión	Año	Descripción	Número Lusac	Posición	Diámetro	Notas	Foto Pág.
DODGE								
CARAVAN		00-07	CILINDRO DE RUEDA	370191	TRAS IZQ DER	13/16"		381
		97-00	CILINDRO MAESTRO	390275		15/16"	FLEX FUEL S/C TRACCIÓN	307
		97-00	CILINDRO MAESTRO	390377		15/16"	FLEX FUEL C/C DE TRACCIÓN	311
		01-07	CILINDRO MAESTRO	390708		15/16"	DISCO-TAMBOR S/ABS	323
		01-02	CILINDRO MAESTRO	390709		1-1/16"	DISCO-DISCO S/C TRACCIÓN	323
		01-02	CILINDRO MAESTRO	390710		1-1/16"	DISCO-DISCO CONTROL DE TRACCIÓN	324
		03-05	CILINDRO MAESTRO	390788		1"	DISCO-DISCO S/C TRACCIÓN	328
		03-07	CILINDRO MAESTRO	390823		25.4 mm 1"	DISCO-DISCO CONTROL DE TRACCIÓN	
		06-07	CILINDRO MAESTRO	390975		15/16"	DISCO-TAMBOR C/ABS	337
		01-07	KIT DE PISTÓN Y REPUESTO FD	742346	DEL	66.0 mm	CHOCOLATE CALIPER ATE	
		08-10	KIT DE PISTÓN Y REPUESTO FD	742424	DEL	66.0 mm	CHOCOLATE	
		87-91	MANGUERA DE FRENOS	38605	TRAS	17.25"		392
		97-00	MANGUERA DE FRENOS	380459	TRAS	17.5"	GASOLINA	421
		96-00	MANGUERA DE FRENOS	380460	DER	20.25"		421
		96-00	MANGUERA DE FRENOS	380461	IZQ	20.25"		421
		05-07	MANGUERA DE FRENOS	382339	IZQ	55.5"	DISCO-DISCO	458
		01-07	MANGUERA DE FRENOS	382347	DER	37"	DISCO-DISCO MINI-VAN PASS (4 PTAS)	458
		01-07	MANGUERA DE FRENOS	382348	DER	37"		458
		01-07	MANGUERA DE FRENOS	382366	DER	25.5"		460
		01-07	MANGUERA DE FRENOS	382367	IZQ	25.5"		460
CHALLENGER	R/T	11-14	MANGUERA DE FRENOS	382355	TRAS IZQ	18.13"		459
	R/T	09-14	MANGUERA DE FRENOS	382372	DEL DER	25.25"		461
	R/T	09-14	MANGUERA DE FRENOS	382375	DEL IZQ	25.38"		461
	SRT-8	08-11	MANGUERA DE FRENOS	382373	DEL IZQ	25.75"		461
	SRT-8	08-11	MANGUERA DE FRENOS	382376	DEL DER	22.13"		461
CHARGER	R/T DAYTONA	08-10	MANGUERA DE FRENOS	382308	DEL DER	19.38"		454
	R/T DAYTONA	08-10	MANGUERA DE FRENOS	382308	DEL IZQ	19.38"		454
	R/T DAYTONA	08-14	MANGUERA DE FRENOS	382355	TRAS IZQ	18.13"		459
	R/T DAYTONA	08-10	MANGUERA DE FRENOS	382356	TRAS IZQ	19.13"		459
	R/T DAYTONA	08-10	MANGUERA DE FRENOS	382358	TRAS DER	19.13"		459
	R/T DAYTONA	08-10	MANGUERA DE FRENOS	382371	DEL DER	25.81"		461
	R/T DAYTONA	08-10	MANGUERA DE FRENOS	382372	DEL DER	25.25"		461
	R/T DAYTONA	08-10	MANGUERA DE FRENOS	382374	DEL IZQ	25.75"		461
	R/T DAYTONA	08-10	MANGUERA DE FRENOS	382375	DEL IZQ	25.38"		461
	R/T DAYTONA	08-10	MANGUERA DE FRENOS	382521	TRAS DER	17.5"		469
	R/T DAYTONA	08-10	PISTÓN FRENO DE DISCO	851021	DEL Y TRAS	42.0mm		531
	SRT-8	07-08	CILINDRO MAESTRO	391126		1-1/16"	6.1 Y 6.4 LTS	343

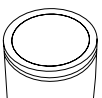



Modelo	Versión	Año	Descripción	Número Lusac	Posición	Diámetro	Notas	Foto Pág.
CHARGER	SRT-8	07-10	MANGUERA DE FRENOS	382360	TRAS DER	17.38"		460
	SRT-8	07-10	MANGUERA DE FRENOS	382361	TRAS IZQ	17.38"		460
	SRT-8	07-14	MANGUERA DE FRENOS	382373	DEL IZQ	25.75"		461
	SRT-8	07-14	MANGUERA DE FRENOS	382376	DEL DER	22.13"		461
	SRT-8	07-10	PISTÓN FRENO DE DISCO	851021	DEL Y TRAS	42.0mm		531
	SXT	06-07	CILINDRO MAESTRO	390978		1"	S/C DE TRACCIÓN	337
	SXT	06-07	CILINDRO MAESTRO	390991		1"	3.5 LTS	338
	SXT	06-07	MANGUERA DE FRENOS	382308	DEL DER	19.38"		454
	SXT	06-07	MANGUERA DE FRENOS	382308	DEL IZQ	19.38"		454
	SXT	06-07	MANGUERA DE FRENOS	382355	TRAS IZQ	18.13"		459
	SXT	06-07	MANGUERA DE FRENOS	382356	TRAS IZQ	19.13"		459
	SXT	06-07	MANGUERA DE FRENOS	382358	TRAS DER	19.13"		459
	SXT	06-07	MANGUERA DE FRENOS	382371	DEL DER	25.81"		461
	SXT	06-07	MANGUERA DE FRENOS	382372	DEL DER	25.25"		461
	SXT	06-07	MANGUERA DE FRENOS	382374	DEL IZQ	25.75"		461
	SXT	06-07	MANGUERA DE FRENOS	382375	DEL IZQ	25.38"		461
	SXT	06-07	MANGUERA DE FRENOS	382521	TRAS DER	17.5"		469
	SXT	06-07	PISTÓN FRENO DE DISCO	851021	DEL Y TRAS	42.0mm		531
		06-09	KIT DE PISTÓN Y REPUESTO FD	742309	DEL TRAS	42.0 mm		
	D-100		88-91	CILINDRO DE CLUTCH	350044	SUP	22.2 mm 7/8"	
		92-93	CILINDRO DE CLUTCH	360046	INF	25.4 mm 1"		
D-150		88-91	CILINDRO DE CLUTCH	350044	SUP	22.2 mm 7/8"		
		92-93	CILINDRO DE CLUTCH	360046	INF	25.4 mm 1"		
		92-93	REPUESTO P/CILINDRO MAESTRO DE CLUTCH	730		22.2 mm 7/8"		556
		92-93	REPUESTO P/CILINDRO MAESTRO DE CLUTCH	735		25.4 mm 1"		557
		81-93	MANGUERA DE FRENOS	4013	DEL DER	15 3/4"		385
		81-93	MANGUERA DE FRENOS	4013	DEL IZQ	15 3/4"		385
		81-90	MANGUERA DE FRENOS	38243	TRAS IZQ	26.13"		389
		90-93	MANGUERA DE FRENOS	38744	TRAS IZQ	26.25"		397
		81-93	PISTÓN FRENO DE DISCO	76021	DEL	78.6 mm 3-3/32"		518
		81-93	REPUESTO FRENO DE DISCO	101491	DEL	78.6 mm 3-3/32"		554
		81-93	CILINDRO DE RUEDA	106315	DER	23.8 mm 15/16"		372
		81-93	CILINDRO DE RUEDA	106315	IZQ	23.8 mm 15/16"		372
		81-93	CILINDRO MAESTRO	98895		28.5 mm 1-1/8"		297
		81-93	REP. CIL. MAESTRO Y DE CLUTCH	101928		28.5 mm 1-1/8"		560
		81-93	REP. CIL. MAESTRO Y DE CLUTCH	101929		28.5 mm 1-1/8"		
D-200		88-91	CILINDRO DE CLUTCH	350044	SUP	22.2 mm 7/8"		
		88-91	CILINDRO DE CLUTCH	350044	SUP	22.2 mm 7/8"		
D-250		92-93	REPUESTO P/CILINDRO MAESTRO DE CLUTCH	730		22.2 mm 7/8"		556
		92-93	REPUESTO P/CILINDRO MAESTRO DE CLUTCH	735		25.4 mm 1"		557
D-250		86-93	MANGUERA DE FRENOS	4013	DEL DER	15 3/4"		385
		86-93	MANGUERA DE FRENOS	4013	DEL IZQ	15 3/4"		385
		86-87	MANGUERA DE FRENOS	38243	TRAS IZQ	26.13"		389
		86-87	MANGUERA DE FRENOS	38744	TRAS DER	26.25"		397
		86-93	MANGUERA DE FRENOS	38744	TRAS IZQ	26.25"		397
		86-87	MANGUERA DE FRENOS	38745	TRAS IZQ	25"		397





Modelo	Versión	Año	Descripción	Número Lusac	Posición	Diámetro	Notas	Foto Pág.	
DODGE									
D-250		86-93	PISTÓN FRENO DE DISCO	76021	DEL	78.6 mm 3-3/32"		518	
		86-93	REPUESTO FRENO DE DISCO	101491	DEL	78.6 mm 3-3/32"		554	
		86-87	CILINDRO DE RUEDA	17507	IZQ	7/8"		364	
		86-87	CILINDRO DE RUEDA	17508	DER	7/8"		364	
		86-87	CILINDRO DE RUEDA	35325	IZQ	28.5 mm 1-1/8"			
		86-87	CILINDRO DE RUEDA	35326	DER	28.5 mm 1-1/8"			
		86-93	CILINDRO DE RUEDA	106315	DER	23.8 mm 15/16"		372	
		86-93	CILINDRO DE RUEDA	106315	IZQ	23.8 mm 15/16"		372	
		86-87	CILINDRO DE RUEDA	106922	IZQ	26.9 mm 1-1/16"			
	86-93	CILINDRO MAESTRO	98895			28.5 mm 1-1/8"		297	
	86-93	REP. CIL. MAESTRO Y DE CLUTCH	101928			28.5 mm 1-1/8"		560	
D-300		88-91	CILINDRO DE CLUTCH	350044	SUP	22.2 mm 7/8"			
		88-91	CILINDRO DE CLUTCH	350044	SUP	22.2 mm 7/8"			
		92-93	REPUESTO P/CILINDRO MAESTRO DE CLUTCH	730		22.2 mm 7/8"		556	
		92-93	REPUESTO P/CILINDRO MAESTRO DE CLUTCH	735		25.4 mm 1"		557	
		88-93	MANGUERA DE FRENOS	4013	DEL DER	15 3/4"		385	
		88-93	MANGUERA DE FRENOS	4013	DEL IZQ	15 3/4"		385	
		81-90	MANGUERA DE FRENOS	5016	TRAS IZQ	23 1/4"			
		81-87	MANGUERA DE FRENOS	38199	DEL IZQ	23.25"			
		81-87	MANGUERA DE FRENOS	38200	DEL DER	23"		389	
		90-93	MANGUERA DE FRENOS	38744	TRAS IZQ	26.25"		397	
		81-93	PISTÓN FRENO DE DISCO	76021	DEL	78.6 mm 3-3/32"		518	
		81-93	REPUESTO FRENO DE DISCO	101491	DEL	78.6 mm 3-3/32"		554	
D-350	INCLUYE MICROBUS	88-90	CILINDRO DE RUEDA	17507	IZQ	7/8"		364	
	INCLUYE MICROBUS	88-90	CILINDRO DE RUEDA	17508	DER	7/8"		364	
	INCLUYE MICROBUS	81-87	CILINDRO DE RUEDA	18984	IZQ	26.9 mm 1-1/16"			
	INCLUYE MICROBUS	81-87	CILINDRO DE RUEDA	18985	DER	26.9 mm 1-1/16"			
	INCLUYE MICROBUS	90-93	CILINDRO DE RUEDA	35325	IZQ	28.5 mm 1-1/8"			
	INCLUYE MICROBUS	90-93	CILINDRO DE RUEDA	35326	DER	28.5 mm 1-1/8"			
	INCLUYE MICROBUS	81-87	CILINDRO DE RUEDA	78974	IZQ	25.4 mm 1"		370	
	INCLUYE MICROBUS	81-87	CILINDRO DE RUEDA	78975	DER	25.4 mm 1"		371	
	INCLUYE MICROBUS	88-90	CILINDRO DE RUEDA	106922	IZQ	26.9 mm 1-1/16"			
	INCLUYE MICROBUS	81-90	CILINDRO MAESTRO	98895			28.5 mm 1-1/8"	SERIE B	297
	INCLUYE MICROBUS	81-93	CILINDRO MAESTRO	98896-A			28.5 mm 1-1/8"	SERIE B y D	
	INCLUYE MICROBUS	81-93	REP. CIL. MAESTRO Y DE CLUTCH	86626			28.5 mm 1-1/8"		558
	INCLUYE MICROBUS	81-90	REP. CIL. MAESTRO Y DE CLUTCH	101928			28.5 mm 1-1/8"		560
	DAKOTA		96-96	MANGUERA DE FRENOS	38636	TRAS IZQ	22.13"		394
		96-96	MANGUERA DE FRENOS	380039	DEL IZQ	19.5"		404	
		96-96	MANGUERA DE FRENOS	380040	DEL DER	19.5"		404	

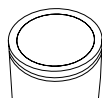



Modelo	Versión	Año	Descripción	Número Lusac	Posición	Diámetro	Notas	Foto Pág.
DAKOTA		05-08	MANGUERA DE FRENOS	382354	TRAS IZQ	23"		459
		05-08	MANGUERA DE FRENOS	382525	DEL DER	18.25"		469
		05-08	MANGUERA DE FRENOS	382525	DEL IZQ	18.25"		469
		96-96	PISTÓN FRENO DE DISCO	115614	DEL	65.9 mm 2-19/32"		529
	LARAMIE	07-10	CILINDRO DE RUEDA	370177	IZQ	26.9 mm 1-1/16"		380
	LARAMIE	07-10	CILINDRO MAESTRO	390926		1-1/8"		335
	LARAMIE	07-10	CILINDRO MAESTRO	390927		1-1/8"		335
	LARAMIE	07-10	MANGUERA DE FRENOS	382354	TRAS IZQ	23"		459
	LARAMIE	07-10	MANGUERA DE FRENOS	382525	DEL DER	18.25"		469
	LARAMIE	07-10	MANGUERA DE FRENOS	382525	DEL IZQ	18.25"		469
		87-94	CILINDRO DE CLUTCH	350021		22.2 mm 7/8"	CHOCOLATE	
		97-01	CILINDRO DE CLUTCH	360084		17.4 mm 11/16"	CHOCOLATE	
		87-95	CILINDRO DE RUEDA	37844	TRAS IZQ DER	3/4"		366
		97-02	CILINDRO DE RUEDA	37844	TRAS IZQ DER	3/4"		366
		00-04	CILINDRO DE RUEDA	78974	IZQ	25.4 mm 1"		370
		00-04	CILINDRO DE RUEDA	78975	DER	25.4 mm 1"		371
		96-96	CILINDRO DE RUEDA	109532	DER	19.0 mm 3/4"		372
		96-96	CILINDRO DE RUEDA	109532	IZQ	19.0 mm 3/4"		372
		11-11	CILINDRO DE RUEDA	370177	TRAS IZQ DER	26.9 mm 1-1/16"		380
		05-08	CILINDRO DE RUEDA	370177	IZQ	26.9 mm 1-1/16"		380
		96-96	CILINDRO MAESTRO	390188		24mm		303
		99-04	CILINDRO MAESTRO	390508		15/16"		316
		05-08	CILINDRO MAESTRO	390926		1-1/8"		335
		11-11	CILINDRO MAESTRO	390927		1-1/8"		335
		91-91	MANGUERA DE FRENOS	38890	DEL DER	17.38"	CHOCOLATE	401
		91-91	MANGUERA DE FRENOS	38891	DEL IZQ	19.75"	CHOCOLATE	401
		91-96	MANGUERA DE FRENOS	38892	DEL DER	29.5"	CHOCOLATE	401
		91-96	MANGUERA DE FRENOS	38893	DEL IZQ	29.5"	CHOCOLATE	401
		97-04	MANGUERA DE FRENOS	380773	CTR	23.25"		427
		97-02	MANGUERA DE FRENOS	381056	DER	24"	4X2	432
		00-00	MANGUERA DE FRENOS	381363	DER	7.25" & 9.75"	4X4	444
		00-00	MANGUERA DE FRENOS	381364	IZQ	7.25" & 10"	4X4	444
		11-11	MANGUERA DE FRENOS	382354	CTR	23"		459
	11-11	MANGUERA DE FRENOS	382525	DEL IZQ DER	18.25"		469	
	03-04	MANGUERA DE FRENOS	382762	DER	38"	4X2	487	
DART	E	89-89	CILINDRO DE RUEDA	107475	DER	14.2 mm 9/16"		372
	E	89-89	CILINDRO DE RUEDA	107475	IZQ	14.2 mm 9/16"		372
	E	89-89	CILINDRO MAESTRO	108134		21.0 mm		297
	E	89-89	MANGUERA DE FRENOS	4072	DEL DER	21 1/4"		386
	E	89-89	MANGUERA DE FRENOS	4073	DEL IZQ	21 1/4"		386
	E	89-89	MANGUERA DE FRENOS	38064	TRAS DER	8.25"		388
	E	89-89	MANGUERA DE FRENOS	38064	TRAS IZQ	8.25"		388
	E	89-89	PISTÓN FRENO DE DISCO	107534	DEL	54.0 mm 2-1/8"		528
	E	89-89	REPUESTO CILINDRO DE RUEDA	112115		21.0 mm 53/64"		561
	E	89-89	REPUESTO FRENO DE DISCO	102443	DEL	54.0 mm 2-1/8"		554
		82-89	KIT DE PISTÓN Y REPUESTO FD	742325	DEL	54.0 mm 2-1/8"	CON CALIPER DE DOBLE PISTON	
		73-76	KIT DE PISTÓN Y REPUESTO	742334	DEL	65.9 mm 2-19/32"		
DART K		85-88	MANGUERA DE FRENOS	4072	DEL DER	21 1/4"		386
		85-88	MANGUERA DE FRENOS	4073	DEL IZQ	21 1/4"		386

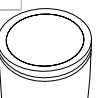



Modelo	Versión	Año	Descripción	Número Lusac	Posición	Diámetro	Notas	Foto Pág.
DODGE								
DART K		85-88	MANGUERA DE FRENOS	38064	TRAS DER	8.25"		388
		85-88	MANGUERA DE FRENOS	38064	TRAS IZQ	8.25"		388
		85-88	PISTÓN FRENO DE DISCO	107534	DEL	54.0 mm 2-1/8"		528
		85-88	REPUESTO FRENO DE DISCO	102443	DEL	54.0 mm 2-1/8"		554
	SEDAN Y GUAYIN	85-88	CILINDRO DE RUEDA	107475	DER	14.2 mm 9/16"		372
	SEDAN Y GUAYIN	85-88	CILINDRO DE RUEDA	107475	IZQ	14.2 mm 9/16"		372
	SEDAN Y GUAYIN	85-88	CILINDRO DE RUEDA	107476	DER	15.8 mm 5/8"		372
	SEDAN Y GUAYIN	85-88	CILINDRO DE RUEDA	107476	IZQ	15.8 mm 5/8"		372
	SEDAN Y GUAYIN	85-88	CILINDRO MAESTRO	108134		21.0 mm		297
SEDAN Y GUAYIN	85-88	REPUESTO CILINDRO DE RUEDA	112115		21.0 mm 53/64"		561	
DM350		88-91	CILINDRO DE CLUTCH	360046	INF	25.4 mm 1"		
DURANGO		98-99	MANGUERA DE FRENOS	380773	TRAS IZQ	23.25"		427
		98-99	MANGUERA DE FRENOS	380979	DEL IZQ	17.5"		430
		98-99	MANGUERA DE FRENOS	380980	DEL DER	17.5"		430
		99-04	MANGUERA DE FRENOS	381056	DEL IZQ	24"		432
		98-99	MANGUERA DE FRENOS	381058	TRAS IZQ	34"		432
		03-06	MANGUERA DE FRENOS	381360	TRAS DER	21.42"		444
		99-06	MANGUERA DE FRENOS	381360	TRAS IZQ	21.42"		444
		00-02	MANGUERA DE FRENOS	381363	DEL DER	7.25" & 9.75"		444
		00-02	MANGUERA DE FRENOS	381364	DEL IZQ	7.25" & 10"		444
		04-09	MANGUERA DE FRENOS	382363	TRAS DER	22"		460
		04-09	MANGUERA DE FRENOS	382363	TRAS IZQ	22"		460
		04-09	MANGUERA DE FRENOS	382682	DEL IZQ	32"		481
		04-09	MANGUERA DE FRENOS	382683	DEL DER	32"		481
		98-02	PISTÓN FRENO DE DISCO	85038	DEL	69.8 mm 2-3/4"		519
		03-09	PISTÓN FRENO DE DISCO	107534	DEL Y TRAS	54.0 mm 2-1/8"		528
		03-09	PISTÓN FRENO DE DISCO	850390	DEL	54.0 mm 2-1/8"	CALIPER DOBLE PISTON	529
		98-02	REPUESTO FRENO DE DISCO	2038	DEL	69.8 mm 2-3/4"		538
		03-06	REPUESTO FRENO DE DISCO	2043	DEL	54.0 mm 2-1/8"	CALIPER DOBLE PISTON	
		03-09	REPUESTO FRENO DE DISCO	2473	DEL Y TRAS	54.0 mm 2-1/8"		541
		03-09	REPUESTO FRENO DE DISCO	21058	DEL	54.0 mm 2-1/8"	CALIPER DOBLE PISTON	549
	SLT, LIMITED	04-06	CILINDRO MAESTRO	390852		1-1/4"	S/C DE TRACCIÓN	332
	SLT, LIMITED	04-06	CILINDRO MAESTRO	390853		1-1/4"	C/C DE TRACCIÓN	332
	SLT, LIMITED	07-09	CILINDRO MAESTRO	391110		1-3/16"		343
SLT, LIMITED	07-09	CILINDRO MAESTRO	391122		1-1/4"		343	
	98-99	CILINDRO DE RUEDA	17507	IZQ	7/8"		364	
	98-99	CILINDRO DE RUEDA	17508	DER	7/8"		364	
	99-04	CILINDRO DE RUEDA	78974	IZQ	25.4 mm 1"		370	

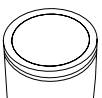



Modelo	Versión	Año	Descripción	Número Lusac	Posición	Diámetro	Notas	Foto Pág.
DURANGO		99-04	CILINDRO DE RUEDA	78975	DER	25.4 mm 1"		371
		98-99	CILINDRO MAESTRO	390408		1-1/16"		312
		99-04	CILINDRO MAESTRO	390508		15/16"		316
		03-04	CILINDRO MAESTRO	390852		1-1/4"	S/C DE TRACCIÓN	332
		03-06	KIT DE PISTÓN Y REPUESTO FD	742326	TRAS	54.0 mm 2-1/8"		
		03-09	KIT DE PISTÓN Y REPUESTO FD	742409	DEL	54.0 mm 2-1/8"		
	03-09	KIT DE PISTÓN Y REPUESTO FD	742412	DEL	54.0 mm 2-1/8"	CON CALIPER DE DOBLE PISTON		
DUSTER		73-76	KIT DE PISTÓN Y REPUESTO FD	742334	DEL	65.9 mm 2-19/32"		
GRAND CARAVAN		00-05	CILINDRO DE RUEDA	370191	TRAS IZQ DER	13/16"	DISCO-TAMBOR	381
		97-00	CILINDRO MAESTRO	390275		15/16"	FWD S/C TRACCIÓN	307
		97-00	CILINDRO MAESTRO	390377		15/16"	FWD C/C DE TRACCIÓN	311
		98-00	CILINDRO MAESTRO	390534		1"	AWD S/C TRACCIÓN	317
		01-05	CILINDRO MAESTRO	390708		15/16"	DISCO-TAMBOR	323
		01-02	CILINDRO MAESTRO	390709		1-1/16"	DISCO-DISCO S/C TRACCIÓN	323
		01-02	CILINDRO MAESTRO	390710		1-1/16"	DISCO-DISCO CONTROL DE TRACCIÓN	324
		03-05	CILINDRO MAESTRO	390788		1"	DISCO-DISCO S/C TRACCIÓN	328
		06-07	CILINDRO MAESTRO	390823		25.4 mm 1"		
		03-05	CILINDRO MAESTRO	390823		25.4 mm 1"	DISCO-DISCO CONTROL DE TRACCIÓN	
		96-00	MANGUERA DE FRENOS	380460	DER	20.25"		421
		96-00	MANGUERA DE FRENOS	380461	IZQ	20.25"		421
		01-02	MANGUERA DE FRENOS	382339	IZQ	55.5"	DISCO-DISCO FWD	458
		05-05	MANGUERA DE FRENOS	382342	DER	37.38"	DISCO-DISCO MINI-VAN PASS (4 PTAS) STOW AND GO SEATS	458
		05-05	MANGUERA DE FRENOS	382344	IZQ	37.38"	DISCO-DISCO MINI-VAN PASS (4 PTAS) STOW AND GO SEATS	458
		01-02	MANGUERA DE FRENOS	382345	IZQ	55.5"	AWD	458
		03-05	MANGUERA DE FRENOS	382346	IZQ	33.5"	DISCO-TAMBOR	458
		01-06	MANGUERA DE FRENOS	382347	DER	37"	MINI-VAN PASS (4 PTAS) S/STOW AND GO SEATS	458
		01-05	MANGUERA DE FRENOS	382348	DER	37"	DISCO-TAMBOR FWD	458
		01-04	MANGUERA DE FRENOS	382350	DER	35.5"	AWD	459
		01-07	MANGUERA DE FRENOS	382366	DER	25.5"		460
		01-07	MANGUERA DE FRENOS	382367	IZQ	25.5"		460
		08-12	MANGUERA DE FRENOS	382519	DER	17.5"		469
	08-12	MANGUERA DE FRENOS	382520	IZQ	17.5"		469	
	08-11	MANGUERA DE FRENOS	382521	IZQ	17.5"		469	
	08-11	MANGUERA DE FRENOS	382522	DER	17.5"		469	
H-100		06-11	CILINDRO DE RUEDA	3700917	TRAS IZQ	17.4 mm 11/16"		384
		06-11	CILINDRO DE RUEDA	3700920	TRAS DER	17.4 mm 11/16"		384
		10-11	CILINDRO DE RUEDA	3700921	TRAS DER	22.2 mm 7/8"		384
		03-10	PISTÓN FRENO DE DISCO	851042	DEL	60.0 mm		532
		03-10	REPUESTO FRENO DE DISCO	21042	DEL	60.0 mm		548
		03-06	CILINDRO DE RUEDA	37009016	DER	22.2 mm 7/8"		





Modelo	Versión	Año	Descripción	Número Lusac	Posición	Diámetro	Notas	Foto Pág.
DODGE								
H-100		03-06	CILINDRO DE RUEDA	37009017	IZQ	22.2 mm 7/8"		
		03-06	CILINDRO MAESTRO	39009900		25.4 mm 1"		360
IMPERIAL		91-91	MANGUERA DE FRENOS	38604	TRAS DER	6.88"		392
		91-91	MANGUERA DE FRENOS	38604	TRAS IZQ	6.88"		392
		91-91	MANGUERA DE FRENOS	380071	DEL DER	23"		406
		91-91	MANGUERA DE FRENOS	380072	DEL IZQ	22.75"		406
		91-91	PISTÓN FRENO DE DISCO	85163	TRAS	36.1 mm 1-27/64"		520
		91-91	PISTÓN FRENO DE DISCO	108159	DEL	60.0 mm		528
		91-91	REPUESTO FRENO DE DISCO	1962	TRAS	36.1 mm 1-27/64"		
		91-91	REPUESTO FRENO DE DISCO	108241	DEL	60.0 mm		554
		91-91	CILINDRO MAESTRO	108168		24.0 mm	ABS	297
		91-91	REP. CIL. MAESTRO Y DE CLUTCH	112246		24.0 mm		561
	INTREPID		94-97	MANGUERA DE FRENOS	380089	TRAS DER	16.5"	
		94-97	MANGUERA DE FRENOS	380091	TRAS DER	19.25"		406
		94-97	MANGUERA DE FRENOS	380092	TRAS IZQ	18"		407
		94-97	MANGUERA DE FRENOS	380206	DEL DER	18"		408
		94-97	MANGUERA DE FRENOS	380207	DEL IZQ	21.5"		408
		98-01	MANGUERA DE FRENOS	381052	TRAS IZQ	13.6"		431
		98-01	MANGUERA DE FRENOS	381053	TRAS DER	13.6"		432
		98-01	MANGUERA DE FRENOS	381054	DEL IZQ	14.38"		432
		98-01	MANGUERA DE FRENOS	381055	DEL DER	14.38"		432
		98-01	PISTÓN FRENO DE DISCO	85163	TRAS	36.1 mm 1-27/64"		520
		94-01	PISTÓN FRENO DE DISCO	108159	DEL	60.0 mm		528
		94-97	PISTÓN FRENO DE DISCO	119043	TRAS	34.9 mm 1-3/8"		529
		98-01	REPUESTO FRENO DE DISCO	1962	TRAS	36.1 mm 1-27/64"		
		94-01	REPUESTO FRENO DE DISCO	108241	DEL	60.0 mm		554
		94-97	REPUESTO FRENO DE DISCO	118265	TRAS	34.1 mm 1-11/32"		554
		94-97	CILINDRO MAESTRO	390110		15/16"	S/ABS	300
		94-97	CILINDRO MAESTRO	390111		15/16"	C/ABS	300
		98-01	CILINDRO MAESTRO	390440		15/16"		313
		01-01	CILINDRO MAESTRO	390719		15/16"		324
JOURNEY			94-01	KIT DE PISTÓN Y REPUESTO FD	742324	DEL	60.0 mm	
		09-12	PISTÓN FRENO DE DISCO	85153	DEL	66.0 mm		519
		09-12	REPUESTO FRENO DE DISCO	21998	DEL	66.0 mm		552
MAGNUM		09-11	KIT DE PISTÓN Y REPUESTO FD	742424	DEL	66.0 mm		
		81-82	MANGUERA DE FRENOS	4023	DEL DER	15 1/4"		
		81-82	MANGUERA DE FRENOS	4022M	DEL IZQ	15 1/4"		
		81-82	PISTÓN FRENO DE DISCO	76018	DEL	69.8 mm 2-3/4"		
		81-82	REPUESTO FRENO DE DISCO	59177	DEL	69.8 mm 2-3/4"		
		81-82	CILINDRO DE RUEDA	106315	DER	23.8 mm 15/16"		372
		81-82	CILINDRO DE RUEDA	106315	IZQ	23.8 mm 15/16"		372
	81-82	CILINDRO MAESTRO	99294		26.1 mm 1-1/32"			

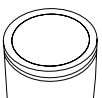

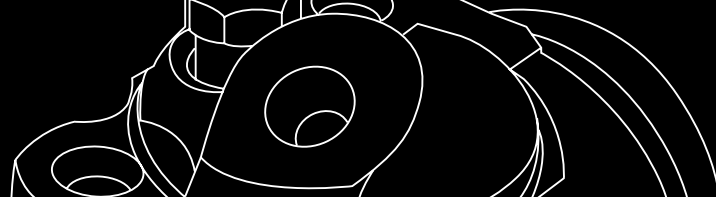

Modelo	Versión	Año	Descripción	Número Lusac	Posición	Diámetro	Notas	Foto Pág.	
MAGNUM		83-88	KIT DE PISTÓN Y REPUESTO FD	742325	DEL	54.0 mm 2-1/8"	CON CALIPER DE DOBLE PISTON		
MAGNUM K		83-88	MANGUERA DE FRENOS	4072	DEL DER	21 1/4"		386	
		83-88	MANGUERA DE FRENOS	4073	DEL IZQ	21 1/4"		386	
		83-88	MANGUERA DE FRENOS	38064	TRAS DER	8.25"		388	
		83-88	MANGUERA DE FRENOS	38064	TRAS IZQ	8.25"		388	
		83-88	PISTÓN FRENO DE DISCO	107534	DEL	54.0 mm 2-1/8"		528	
		83-88	REPUESTO FRENO DE DISCO	102443	DEL	54.0 mm 2-1/8"		554	
		83-88	CILINDRO DE RUEDA	107475	DER	14.2 mm 9/16"		372	
		83-88	CILINDRO DE RUEDA	107475	IZQ	14.2 mm 9/16"		372	
		83-88	CILINDRO DE RUEDA	107476	DER	15.8 mm 5/8"		372	
		83-88	CILINDRO DE RUEDA	107476	IZQ	15.8 mm 5/8"		372	
		83-88	CILINDRO MAESTRO	108134		21.0 mm		297	
	83-88	REPUESTO CILINDRO DE RUEDA	112115		21.0 mm 53/64"		561		
MICROBÚS		92-93	REPUESTO P/CILINDRO MAESTRO DE CLUTCH	730		22.2 mm 7/8"		556	
		92-93	REPUESTO P/CILINDRO MAESTRO DE CLUTCH	735		25.4 mm 1"		557	
NEON		95-99	MANGUERA DE FRENOS	380329	TRAS DER	24"		413	
		95-99	MANGUERA DE FRENOS	380330	TRAS IZQ	24"		414	
		95-99	MANGUERA DE FRENOS	380333	DEL DER	20.75"		414	
		95-99	MANGUERA DE FRENOS	380334	DEL IZQ	20.75"		414	
		95-96	MANGUERA DE FRENOS	380335	TRAS DER	17.13"		414	
		95-96	MANGUERA DE FRENOS	380336	TRAS IZQ	17.13"		414	
		95-99	MANGUERA DE FRENOS	380337	TRAS DER	17.75"		414	
		95-99	MANGUERA DE FRENOS	380338	TRAS IZQ	17.13"		414	
		00-05	MANGUERA DE FRENOS	381378	TRAS DER	18.23"		445	
		00-05	MANGUERA DE FRENOS	381379	TRAS IZQ	18.23"		445	
		00-05	MANGUERA DE FRENOS	382325	DEL DER	18.5"		456	
		00-05	MANGUERA DE FRENOS	382326	DEL IZQ	18.5"		456	
		03-05	MANGUERA DE FRENOS	382327	TRAS DER	21.38"		456	
		03-05	MANGUERA DE FRENOS	382328	TRAS IZQ	21.38"		457	
		95-05	PISTÓN FRENO DE DISCO	107534	DEL	54.0 mm 2-1/8"		528	
		95-05	PISTÓN FRENO DE DISCO	119043	TRAS	34.9 mm 1-3/8"		529	
		95-05	REPUESTO FRENO DE DISCO	102443	DEL	54.0 mm 2-1/8"		554	
		95-05	REPUESTO FRENO DE DISCO	118265	TRAS	34.1 mm 1-11/32"		554	
	SEDAN Y R/T		00-05	CILINDRO DE RUEDA	37787	DER	11/16"		366
	SEDAN Y R/T		00-05	CILINDRO DE RUEDA	37787	IZQ	11/16"		366
	SEDAN Y R/T		00-02	CILINDRO DE RUEDA	370081	IZQ	17.4 mm 11/16"		375
	SEDAN Y R/T		00-05	CILINDRO MAESTRO	390577		15/16"	DISCO-DISCO C/ABS	319
	SEDAN Y R/T		00-05	CILINDRO MAESTRO	390579		7/8"	DISCO-TAMBOR	319
	SEDAN Y R/T		00-05	CILINDRO MAESTRO	390638		15/16"	DISCO-TAMBOR S/ABS	321
SEDAN Y R/T		00-02	CILINDRO MAESTRO	5015160		23.8 mm 15/16"	DISCO-DISCO C/ABS	359	
SEDAN Y R/T		00-02	CILINDRO MAESTRO	5017973		23.8 mm 15/16"	S/ABS	359	
SRT-4		04-05	CILINDRO MAESTRO	390577		15/16"	DISCO-DISCO C/ABS	319	





Modelo	Versión	Año	Descripción	Número Lusac	Posición	Diámetro	Notas	Foto Pág.
DODGE								
NEON	SRT-4	04-05	CILINDRO MAESTRO	390638		15/16"	DISCO-TAM-BOR S/ABS	321
	SRT-4	04-05	MANGUERA DE FRENOS	381378	TRAS DER	18.23"		445
	SRT-4	04-05	MANGUERA DE FRENOS	381379	TRAS IZQ	18.23"		445
	SRT-4	04-05	MANGUERA DE FRENOS	382325	DEL DER	18.5"		456
	SRT-4	04-05	MANGUERA DE FRENOS	382326	DEL IZQ	18.5"		456
	SRT-4	04-05	MANGUERA DE FRENOS	382327	TRAS DER	21.38"		456
	SRT-4	04-05	MANGUERA DE FRENOS	382328	TRAS IZQ	21.38"		457
		95-99	CILINDRO DE RUEDA	107476	DER	15.8 mm 5/8"		372
		95-99	CILINDRO DE RUEDA	107476	IZQ	15.8 mm 5/8"		372
		95-96	CILINDRO MAESTRO	390204		21mm	DISCO-TAM-BOR S/ABS	303
		95-96	CILINDRO MAESTRO	390205		21mm	DISCO-TAM-BOR C/ABS	303
		95-99	CILINDRO MAESTRO	390213		7/8"	S/ABS	303
		95-99	CILINDRO MAESTRO	390215		7/8"	DISCO-DISCO C/ABS	303
		95-96	REP. CIL. MAESTRO Y DE CLUTCH	90203		21.0 mm 53/64"		
		95-99	REP. CIL. MAESTRO Y DE CLUTCH	90204		22.2 mm 7/8"		
		95-99	REP. CIL. MAESTRO Y DE CLUTCH	90215		22.2 mm 7/8"		
NITRO		07-10	PISTÓN FRENO DE DISCO	85153	DEL	66.0 mm		519
		07-10	REPUESTO FRENO DE DISCO	21998	DEL	66.0 mm		552
		07-12	CILINDRO MAESTRO	391123		1"		
		07-10	KIT DE PISTÓN Y REPUESTO FD	742424	DEL	66.0 mm		
RAM		98-99	MANGUERA DE FRENOS	38576	TRAS DER	21.88"		392
RAM 1500		98-99	MANGUERA DE FRENOS	38576	TRAS IZQ	21.88"		392
		94-97	MANGUERA DE FRENOS	38636	TRAS DER	22.13"		394
		94-97	MANGUERA DE FRENOS	38636	TRAS IZQ	22.13"		394
		94-99	MANGUERA DE FRENOS	380339	DEL IZQ	19"		415
		94-99	MANGUERA DE FRENOS	380340	DEL DER	18.75"		415
		94-99	MANGUERA DE FRENOS	380342	DEL DER	19"		415
		94-99	MANGUERA DE FRENOS	380343	DEL IZQ	39.25"		415
		94-99	MANGUERA DE FRENOS	380344	DEL DER	39.25"		415
		94-99	MANGUERA DE FRENOS	380345	DEL IZQ	39.25"		415
		95-99	MANGUERA DE FRENOS	380747	DEL IZQ	19.5"		427
		00-01	MANGUERA DE FRENOS	381339	DEL DER	20.46"		442
		00-01	MANGUERA DE FRENOS	381340	DEL IZQ	18.12"		442
		00-01	MANGUERA DE FRENOS	381354	DEL DER	22.06"		443
		00-01	MANGUERA DE FRENOS	381355	DEL IZQ	21"		444
		00-01	MANGUERA DE FRENOS	381367	TRAS DER	22.13"		444
		00-01	MANGUERA DE FRENOS	381367	TRAS IZQ	22.13"		444
		02-02	MANGUERA DE FRENOS	381513	TRAS DER	25.37"		447
		02-02	MANGUERA DE FRENOS	381513	TRAS IZQ	25.37"		447
		00-01	MANGUERA DE FRENOS	382305	DEL DER	39"		454
		00-01	MANGUERA DE FRENOS	382305	DEL IZQ	39"		454
		00-02	MANGUERA DE FRENOS	382323	DEL DER	43.25"		456
		00-02	MANGUERA DE FRENOS	382324	DEL IZQ	42.0"		456
		05-08	MANGUERA DE FRENOS	382364	DEL DER	20.38"		460
		05-08	MANGUERA DE FRENOS	382377	DEL DER	34.25"		461
		05-08	MANGUERA DE FRENOS	382378	DEL IZQ	33"		461
		05-08	MANGUERA DE FRENOS	382379	DEL IZQ	20.25"		461
		02-04	MANGUERA DE FRENOS	382380	DEL IZQ	30.38"		462

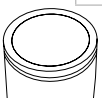



Modelo	Versión	Año	Descripción	Número Lusac	Posición	Diámetro	Notas	Foto Pág.
RAM 1500		02-06	MANGUERA DE FRENOS	382381	DEL IZQ	30.38"		462
		02-04	MANGUERA DE FRENOS	382383	DEL IZQ	30.38"		462
		07-08	MANGUERA DE FRENOS	382528	TRAS IZQ	19.75"		469
		94-00	PISTÓN FRENO DE DISCO	85157	DEL	74.6 mm 2-15/16"		520
		03-08	PISTÓN FRENO DE DISCO	85489	TRAS	45.0 mm		525
		01-08	PISTÓN FRENO DE DISCO	107534	DEL Y TRAS	54.0 mm 2-1/8"	CALIPER DOBLE PISTON	528
		01-06	PISTÓN FRENO DE DISCO	850390	TRAS	54.0 mm 2-1/8"	CALIPER DOBLE PISTON	529
		94-00	REPUESTO FRENO DE DISCO	2005	DEL	74.6 mm 2-15/16"		538
		03-08	REPUESTO FRENO DE DISCO	2473	DEL Y TRAS	54.0 mm 2-1/8"		541
		03-08	REPUESTO FRENO DE DISCO	2489	TRAS	45.0 mm		542
		01-06	REPUESTO FRENO DE DISCO	21058	DEL	54.0 mm 2-1/8"	CALIPER DOBLE PISTON	549
		01-08	REPUESTO FRENO DE DISCO	102443	DEL	54.0 mm 2-1/8"	CALIPER DOBLE PISTON	554
	PROMASTER	13-14	CILINDRO MAESTRO	391121		1-1/4"		343
	SLT	06-06	CILINDRO MAESTRO	390976		1-1/4"		337
	ST	09-10	CILINDRO MAESTRO	390782		1-5/16"	4X4	328
	ST	09-12	CILINDRO MAESTRO	391121		1-1/4"	4X2	343
	ST	09-10	MANGUERA DE FRENOS	382364	DEL DER	20.38"		460
	ST	09-10	MANGUERA DE FRENOS	382377	DEL DER	34.25"		461
	ST	09-10	MANGUERA DE FRENOS	382378	DEL IZQ	33"		461
	ST	09-10	MANGUERA DE FRENOS	382379	DEL IZQ	20.25"		461
	ST	09-12	PISTÓN FRENO DE DISCO	107534	DEL Y TRAS	54.0 mm 2-1/8"		528
	ST	09-12	REPUESTO FRENO DE DISCO	2473	TRAS	54.0 mm 2-1/8"		541
		94-97	CILINDRO DE CLUTCH	350058	SUP	22.2 mm 7/8"		
		98-01	CILINDRO DE CLUTCH	350112		18.0 mm		
		98-01	CILINDRO DE CLUTCH	360085		21.0 mm 53/64"		
		94-01	CILINDRO DE RUEDA	37985	DER	15/16"		369
		94-01	CILINDRO DE RUEDA	37985	IZQ	15/16"		369
		02-02	CILINDRO DE RUEDA	78974	IZQ	25.4 mm 1"		370
		02-02	CILINDRO DE RUEDA	78975	DER	25.4 mm 1"		371
		94-94	CILINDRO MAESTRO	39646		28.6mm & 40mm	4X2; 4X4	294
		97-97	CILINDRO MAESTRO	390257		1-1/4"	4X2; 4X4	306
		95-96	CILINDRO MAESTRO	390259		40mm & 1/8"	4X2; 4X4	306
		97-01	CILINDRO MAESTRO	390426		1-1/4"	4X2; 4X4	313
		00-01	CILINDRO MAESTRO	390426		1-1/4"	C/ABS 4X4	313
		03-08	CILINDRO MAESTRO	390742		1-5/16"		325
		02-08	CILINDRO MAESTRO	390782		1-5/16"		328
		03-06	CILINDRO MAESTRO	390821		1-5/16"		330
		07-08	CILINDRO MAESTRO	391121		1-1/4"	4X2; 4X4	343
		03-04	CILINDRO MAESTRO	5080888		33.3 mm 1-5/16"	C/ABS 3.7 LTS	359
		02-02	CILINDRO MAESTRO	5080888		33.3 mm 1-5/16"	C/ABS, 4X4 C/ABS, 4X4	359
		01-08	KIT DE PISTÓN Y REPUESTO FD	742325	DEL	54.0 mm 2-1/8"		
		03-08	KIT DE PISTÓN Y REPUESTO FD	742326	TRAS	54.0 mm 2-1/8"		
	94-00	KIT DE PISTÓN Y REPUESTO FD	742351	DEL	74.6 mm 2-15/16"			





Modelo	Versión	Año	Descripción	Número Lusac	Posición	Diámetro	Notas	Foto Pág.
DODGE								
RAM 2500		01-10	KIT DE PISTÓN Y REPUESTO FD	742409	DEL	54.0 mm 2-1/8"		
		12-12	MANGUERA DE FRENOS	382364	DER	20.38"	4X2	460
		12-12	MANGUERA DE FRENOS	382379	IZQ	20.25"	4X2	461
		06-06	MANGUERA DE FRENOS	382524	DEL DER	13.7"		469
		07-09	MANGUERA DE FRENOS	382529	TRAS CENTRAL	23"	C/ABS	469
		07-09	MANGUERA DE FRENOS	382530	TRAS CENTRAL A LAS RUEDAS TRASERAS	(2)11.19"	C/ABS	469
		94-94	REP. CIL. MAESTRO Y DE CLUTCH	1737		28.5 mm 1-1/8"		557
		97-97	REP. CIL. MAESTRO Y DE CLUTCH	39650		31.7 mm 1-1/4"		557
		97-01	REP. CIL. MAESTRO Y DE CLUTCH	90426		31.7 mm 1-1/4"		559
		95-96	REP. CIL. MAESTRO Y DE CLUTCH	104459		28.5 mm 1-1/8"		560
		94-97	REPUESTO P/CILINDRO MAESTRO DE CLUTCH	60051	INF	25.4 mm 1"		558
		91-93	MANGUERA DE FRENOS	4013	DEL IZQ	15 3/4"		385
		98-99	MANGUERA DE FRENOS	38576	TRAS IZQ	21.88"		392
		91-97	MANGUERA DE FRENOS	38636	TRAS IZQ	22.13"		394
		98-99	MANGUERA DE FRENOS	380303	DEL IZQ	19.5"		412
		91-95	MANGUERA DE FRENOS	380339	DEL IZQ	19"		415
		91-97	MANGUERA DE FRENOS	380340	DEL DER	18.75"		415
		94-94	MANGUERA DE FRENOS	380342	DEL DER	19"		415
		96-99	MANGUERA DE FRENOS	380343	DEL IZQ	39.25"		415
		94-94	MANGUERA DE FRENOS	380344	DEL DER	39.25"		415
		96-99	MANGUERA DE FRENOS	380344	DEL DER	39.25"		415
		94-94	MANGUERA DE FRENOS	380345	DEL IZQ	39.25"		415
		96-99	MANGUERA DE FRENOS	380541	DEL DER	32"		425
		96-97	MANGUERA DE FRENOS	380747	DEL IZQ	19.5"		427
		98-99	MANGUERA DE FRENOS	381282	TRAS IZQ	19.72"		439
		00-01	MANGUERA DE FRENOS	381339	DEL DER	20.46"		442
		00-01	MANGUERA DE FRENOS	381340	DEL IZQ	18.12"		442
		01-02	MANGUERA DE FRENOS	381354	DEL DER	22.06"		443
		01-02	MANGUERA DE FRENOS	381355	DEL IZQ	21"		444
		00-00	MANGUERA DE FRENOS	381367	TRAS IZQ	22.13"		444
		02-04	MANGUERA DE FRENOS	381475	DEL IZQ	22.13"		447
		01-02	MANGUERA DE FRENOS	381475	TRAS IZQ	22.13"		447
		03-04	MANGUERA DE FRENOS	381514	TRAS DER	25.67"		447
		03-04	MANGUERA DE FRENOS	381514	TRAS IZQ	25.67"		447
		01-01	MANGUERA DE FRENOS	382304	DEL IZQ	43"		454
		01-01	MANGUERA DE FRENOS	382305	DEL DER	39"		454
		02-02	MANGUERA DE FRENOS	382323	DEL DER	43.25"		456
		02-02	MANGUERA DE FRENOS	382324	DEL IZQ	42.0"		456
		03-14	MANGUERA DE FRENOS	382364	DEL DER	20.38"		460
		03-14	MANGUERA DE FRENOS	382377	DEL DER	34.25"		461
		05-08	MANGUERA DE FRENOS	382378	DEL IZQ	33"		461
		03-12	MANGUERA DE FRENOS	382379	DEL IZQ	20.25"		461
	03-04	MANGUERA DE FRENOS	382458	DEL IZQ	32.5"		466	
	09-12	MANGUERA DE FRENOS	382458	DEL IZQ	32.5"		466	
	91-00	PISTÓN FRENO DE DISCO	85157	DEL	74.6 mm 2-15/16"		520	

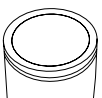



Modelo	Versión	Año	Descripción	Número Lusac	Posición	Diámetro	Notas	Foto Pág.
RAM 2500		01-08	PISTÓN FRENO DE DISCO	85489	TRAS	45.0 mm		525
		01-04	PISTÓN FRENO DE DISCO	107534	DEL	54.0 mm 2-1/8"	CALIPER DOBLE PISTON	528
		01-12	PISTÓN FRENO DE DISCO	850390	DEL Y TRAS	54.0 mm 2-1/8"	CALIPER DOBLE PISTON	529
		91-00	REPUESTO FRENO DE DISCO	2005	DEL	74.6 mm 2-15/16"		538
		03-12	REPUESTO FRENO DE DISCO	2473	TRAS	54.0 mm 2-1/8"		541
		01-08	REPUESTO FRENO DE DISCO	2489	TRAS	45.0 mm		542
		01-08	REPUESTO FRENO DE DISCO	21058	DEL	54.0 mm 2-1/8"	CALIPER DOBLE PISTON	549
		01-04	REPUESTO FRENO DE DISCO	102443	DEL	54.0 mm 2-1/8"	CALIPER DOBLE PISTON	554
	HEAVY DUTY	08-10	CILINDRO MAESTRO	390742		1-5/16"	GASOLINA C/ BOOSTER DE VACÍO	325
	HEAVY DUTY	08-10	CILINDRO MAESTRO	391033		1-5/16"	DIESEL HYDRO-BOOST	340
	HEAVY DUTY	09-10	MANGUERA DE FRENOS	381514	CTR	25.67"		447
	HEAVY DUTY	09-10	MANGUERA DE FRENOS	382364	DER	20.38"	4X2	460
	HEAVY DUTY	09-10	MANGUERA DE FRENOS	382377	DER	34.25"	4X4	461
	HEAVY DUTY	09-10	MANGUERA DE FRENOS	382379	IZQ	20.25"	4X2	461
	HEAVY DUTY	09-10	MANGUERA DE FRENOS	382458	IZQ	32.5"	4X4	466
	INLUYE CLUB CAB	91-97	CILINDRO DE RUEDA	37985	DER	15/16"		369
	INLUYE CLUB CAB	91-97	CILINDRO DE RUEDA	37985	IZQ	15/16"		369
	INLUYE CLUB CAB	91-93	CILINDRO MAESTRO	39646		28.6mm & 40mm		294
	INLUYE CLUB CAB	94-97	CILINDRO MAESTRO	390257		1-1/4"		306
	INLUYE CLUB CAB	94-97	CILINDRO MAESTRO	390259		40mm & 1/8"		306
	INLUYE CLUB CAB	91-93	REP. CIL. MAESTRO Y DE CLUTCH	1737		28.5 mm 1-1/8"		557
	INLUYE CLUB CAB	94-97	REP. CIL. MAESTRO Y DE CLUTCH	39650		31.7 mm 1-1/4"		557
	INLUYE CLUB CAB	94-97	REP. CIL. MAESTRO Y DE CLUTCH	104459		28.5 mm 1-1/8"		560
	INLUYE QUAD CAB	98-01	CILINDRO DE RUEDA	37985	DER	15/16"		369
	INLUYE QUAD CAB	98-01	CILINDRO DE RUEDA	37985	IZQ	15/16"		369
	INLUYE QUAD CAB	98-99	CILINDRO MAESTRO	390257		1-1/4"		306
	INLUYE QUAD CAB	98-01	CILINDRO MAESTRO	390426		1-1/4"		313
	INLUYE QUAD CAB	03-06	CILINDRO MAESTRO	390708		15/16"	4X2	323
	INLUYE QUAD CAB	01-02	CILINDRO MAESTRO	390732		1-5/16"		324
	INLUYE QUAD CAB	05-06	CILINDRO MAESTRO	390742		1-5/16"	C/ABS	325
	INLUYE QUAD CAB	03-06	CILINDRO MAESTRO	390782		1-5/16"	4X4	328
	INLUYE QUAD CAB	05-06	CILINDRO MAESTRO	391033		1-5/16"	DIESEL	340





Modelo	Versión	Año	Descripción	Número Lusac	Posición	Diámetro	Notas	Foto Pág.
DODGE								
RAM 2500	INLUYE QUAD CAB	98-99	REP. CIL. MAESTRO Y DE CLUTCH	39650		31.7 mm 1-1/4"		557
	INLUYE QUAD CAB	98-01	REP. CIL. MAESTRO Y DE CLUTCH	90426		31.7 mm 1-1/4"		559
	MEGA CAB LARAMIE	06-08	MANGUERA DE FRENOS	382364	DEL IZQ	20.38"		460
	MEGA CAB LARAMIE	06-08	PISTÓN FRENO DE DISCO	85489	TRAS	45.0 mm		525
	MEGA CAB LARAMIE	06-08	REPUESTO FRENO DE DISCO	2489	TRAS	45.0 mm		542
	QUAD CAB, SLT, DIESEL	03-07	CILINDRO MAESTRO	390708		15/16"	4X2	323
	QUAD CAB, SLT, DIESEL	03-07	CILINDRO MAESTRO	390782		1-5/16"	4X4	328
	QUAD CAB, SLT, DIESEL	03-07	MANGUERA DE FRENOS	381514	TRAS DER	25.67"		447
	QUAD CAB, SLT, DIESEL	03-07	MANGUERA DE FRENOS	381514	TRAS IZQ	25.67"		447
	QUAD CAB, SLT, DIESEL	03-07	MANGUERA DE FRENOS	382364	DEL DER	20.38"		460
	QUAD CAB, SLT, DIESEL	03-07	MANGUERA DE FRENOS	382379	DEL IZQ	20.25"		461
	QUAD CAB, SLT, DIESEL	03-07	PISTÓN FRENO DE DISCO	85489	TRAS	45.0 mm		525
	QUAD CAB, SLT, DIESEL	03-07	REPUESTO FRENO DE DISCO	2489	TRAS	45.0 mm		542
	ST, QUAD CAB SLT	07-08	CILINDRO MAESTRO	390708		15/16"	4X2	323
	ST, QUAD CAB SLT	07-08	CILINDRO MAESTRO	390742		1-5/16"	C/ABS	325
	ST, QUAD CAB SLT	07-08	CILINDRO MAESTRO	390782		1-5/16"	4X4	328
	ST, QUAD CAB SLT	07-08	CILINDRO MAESTRO	391033		1-5/16"	DIESEL	340
		94-97	CILINDRO DE CLUTCH	350058	SUP	22.2 mm 7/8"		
		98-01	CILINDRO DE CLUTCH	350112		18.0 mm		
		98-01	CILINDRO DE CLUTCH	360085		21.0 mm 53/64"		
		09-11	CILINDRO MAESTRO	390742		1-5/16"	GASOLINA C/ BOOSTER DE VACÍO	325
		09-10	CILINDRO MAESTRO	390782		1-5/16"	4X4	328
		09-11	CILINDRO MAESTRO	391033		1-5/16"	DIESEL HY- DRO-BOOST	340
		11-12	CILINDRO MAESTRO	391121		1-1/4"	4X2	343
		01-04	KIT DE PISTÓN Y REPUESTO FD	742325	DEL	54.0 mm 2-1/8"	CON CALIPER DE DOBLE PISTON	
		03-04	KIT DE PISTÓN Y REPUESTO FD	742326	TRAS	54.0 mm 2-1/8"		
		91-00	KIT DE PISTÓN Y REPUESTO FD	742351	DEL	74.6 mm 2-15/16"		
		01-10	KIT DE PISTÓN Y REPUESTO FD	742409	DEL	54.0 mm 2-1/8"	CON CALIPER DE DOBLE PISTON	
		11-11	MANGUERA DE FRENOS	381514	CTR	25.67"		447
		11-13	MANGUERA DE FRENOS	382364	DER	20.38"	4X2	460
		11-13	MANGUERA DE FRENOS	382377	DER	34.25"	4X4	461
		11-12	MANGUERA DE FRENOS	382379	IZQ	20.25"	4X2	461
	11-12	MANGUERA DE FRENOS	382458	IZQ	32.5"	4X4	466	
	94-97	REPUESTO P/CILINDRO MAESTRO DE CLUTCH	60051	INF	25.4 mm 1"		558	
RAM 3500	94-94	MANGUERA DE FRENOS	38636	TRAS IZQ	22.13"		394	
	98-99	MANGUERA DE FRENOS	38636	TRAS IZQ	22.13"		394	
	95-97	MANGUERA DE FRENOS	38745	TRAS IZQ	25"		397	

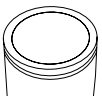



Modelo	Versión	Año	Descripción	Número Lusac	Posición	Diámetro	Notas	Foto Pág.
RAM 3500		94-97	MANGUERA DE FRENOS	380339	DEL IZQ	19"		415
		94-97	MANGUERA DE FRENOS	380340	DEL DER	18.75"		415
		94-97	MANGUERA DE FRENOS	380343	DEL IZQ	39.25"		415
		94-99	MANGUERA DE FRENOS	380344	DEL DER	39.25"		415
		98-99	MANGUERA DE FRENOS	380541	DEL IZQ	32"	DS TAMBIEN PUEDE LLEVAR LA MANGERA CENTRAL 382354 00-01	425
		00-02	MANGUERA DE FRENOS	381339	DEL DER	20.46"	DS TAMBIÉN PUEDE LLEVAR LA MANGERA DEL IZQ 382304 Y DEL DER 382305 00-01	442
		00-02	MANGUERA DE FRENOS	381340	DEL IZQ	18.12"	DS SI LA CAMIONETA ES 4X2, PUEDE LLEVAR LA MANGUERA 381355 Y 381354 DELANTERAS EN 00-01	442
		00-02	MANGUERA DE FRENOS	381367	TRAS IZQ	22.13"	SI LA CAMIONETA ES 4X2, PUEDE LLEVAR LA MANGUERA 381355 Y 381354 DELANTERAS EN 00-01	444
		00-02	MANGUERA DE FRENOS	382323	DEL DER	43.25"		456
		00-02	MANGUERA DE FRENOS	382324	DEL IZQ	42.0"		456
		94-99	PISTÓN FRENO DE DISCO	85206	DEL	86.1 mm 3-25/64"		521
		00-02	PISTÓN FRENO DE DISCO	850300	DEL	55.9 mm 2-13/64"	CALIPER DOBLE PISTON	529
		94-99	REPUESTO FRENO DE DISCO	2033	DEL	86.1 mm 3-25/64"		538
		00-02	REPUESTO FRENO DE DISCO	2154	DEL	55.9 mm 2-13/64"	CALIPER DOBLE PISTON	540
		94-97	CILINDRO DE CLUTCH	350058	SUP	22.2 mm 7/8"		
		98-01	CILINDRO DE CLUTCH	350112		18.0 mm		
		98-01	CILINDRO DE CLUTCH	360085		21.0 mm 53/64"		
		94-02	CILINDRO DE RUEDA	79767	DER	26.9 mm 1-1/16"		371
		94-02	CILINDRO DE RUEDA	79767	IZQ	26.9 mm 1-1/16"		371
		94-94	CILINDRO MAESTRO	390190		1-1/4"	4X2, 4X4	303
		95-97	CILINDRO MAESTRO	390258		1-1/4"	4X2, 4X4	306
		98-02	CILINDRO MAESTRO	390426		1-1/4"	4X2, 4X4	313
		00-02	CILINDRO MAESTRO	390732		1-5/16"		324
		98-02	REP. CIL. MAESTRO Y DE CLUTCH	90426		31.7 mm 1-1/4"		559
		94-97	REPUESTO P/CILINDRO MAESTRO DE CLUTCH	60051	INF	25.4 mm 1"		558
	RAM 4000		98-99	MANGUERA DE FRENOS	38636	TRAS IZQ	22.13"	
		95-97	MANGUERA DE FRENOS	38745	TRAS IZQ	25"		397
		95-97	MANGUERA DE FRENOS	380343	DEL IZQ	39.25"		415
		95-99	MANGUERA DE FRENOS	380344	DEL DER	39.25"		415
		98-99	MANGUERA DE FRENOS	380541	DEL IZQ	32"		425
		00-01	MANGUERA DE FRENOS	381339	DEL DER	20.46"		442
		00-01	MANGUERA DE FRENOS	381340	DEL IZQ	18.12"		442
		00-01	MANGUERA DE FRENOS	381367	TRAS IZQ	22.13"		444
		95-99	PISTÓN FRENO DE DISCO	85206	DEL	86.1 mm 3-25/64"		521
		05-08	PISTÓN FRENO DE DISCO	85489	TRAS	45.0 mm		525
		00-02	PISTÓN FRENO DE DISCO	850300	DEL	55.9 mm 2-13/64"	CALIPER DOBLE PISTON	529
		05-06	PISTÓN FRENO DE DISCO	850300	DEL	55.9 mm 2-13/64"	CALIPER DOBLE PISTON	529

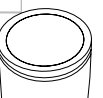



Modelo	Versión	Año	Descripción	Número Lusac	Posición	Diámetro	Notas	Foto Pág.
DODGE								
RAM 4000		95-99	REPUESTO FRENO DE DISCO	2033	DEL	86.1 mm 3-25/64"		538
		00-02	REPUESTO FRENO DE DISCO	2154	DEL	55.9 mm 2-13/64"	CALIPER DOBLE PISTON	540
		05-06	REPUESTO FRENO DE DISCO	2154	DEL	55.9 mm 2-13/64"	CALIPER DOBLE PISTON	540
		05-08	REPUESTO FRENO DE DISCO	2489	TRAS	45.0 mm		542
		95-02	CILINDRO DE RUEDA	79767	DER	26.9 mm 1-1/16"		371
		95-02	CILINDRO DE RUEDA	79767	IZQ	26.9 mm 1-1/16"		371
		95-97	CILINDRO MAESTRO	390258		1-1/4"		306
		05-06	CILINDRO MAESTRO	390377		15/16"	C/C DE TRACCIÓN	311
		98-01	CILINDRO MAESTRO	390426		1-1/4"		313
		02-02	CILINDRO MAESTRO	390732		1-5/16"		324
		00-02	KIT DE PISTÓN Y REPUESTO FD	742337	DEL	55.9 mm 2-13/64"	CON CALIPER DE DOBLE PISTON	
		05-06	KIT DE PISTÓN Y REPUESTO FD	742337	DEL	55.9 mm 2-13/64"	CON CALIPER DE DOBLE PISTON	
		98-01	REP. CIL. MAESTRO Y DE CLUTCH	90426		31.7 mm 1-1/4"		559
RAM CHARGER		86-96	MANGUERA DE FRENOS	4013	DEL DER	15 3/4"		385
		86-96	MANGUERA DE FRENOS	4013	DEL IZQ	15 3/4"		385
		86-96	MANGUERA DE FRENOS	38243	TRAS IZQ	26.13"	ESTE VEHICULO PUEDE LLEVAR LA MANGUERA 38576 TRAS.	389
		99-99	MANGUERA DE FRENOS	38576	TRAS IZQ	21.88"		392
		99-99	MANGUERA DE FRENOS	380303	DEL IZQ	19.5"		412
		99-99	MANGUERA DE FRENOS	380340	DEL DER	18.75"		415
		99-99	MANGUERA DE FRENOS	380541	DEL DER	32"		425
		99-99	MANGUERA DE FRENOS	380747	DEL IZQ	19.5"		427
		00-01	MANGUERA DE FRENOS	381339	DEL DER	20.46"		442
		00-01	MANGUERA DE FRENOS	381340	DEL IZQ	18.12"		442
		00-01	MANGUERA DE FRENOS	381367	TRAS DER	22.13"		444
		00-01	MANGUERA DE FRENOS	381367	TRAS IZQ	22.13"		444
		86-96	PISTÓN FRENO DE DISCO	76026	DEL	78.6 mm 3-3/32"		518
		99-99	PISTÓN FRENO DE DISCO	85157	DEL	74.6 mm 2-15/16"		520
		00-01	PISTÓN FRENO DE DISCO	107534	DEL	54.0 mm 2-1/8"	CALIPER DOBLE PISTON	528
		99-99	REPUESTO FRENO DE DISCO	2005	DEL	74.6 mm 2-15/16"		538
		86-96	REPUESTO FRENO DE DISCO	101491	DEL	78.6 mm 3-3/32"		554
		00-01	REPUESTO FRENO DE DISCO	102443	DEL	54.0 mm 2-1/8"	CALIPER DOBLE PISTON	554
		92-93	CILINDRO DE CLUTCH	360046	INF	25.4 mm 1"		
		86-96	CILINDRO DE RUEDA	106315	DER	23.8 mm 15/16"		372
		99-01	CILINDRO DE RUEDA	106315	DER	23.8 mm 15/16"		372
		86-96	CILINDRO DE RUEDA	106315	IZQ	23.8 mm 15/16"		372
		99-01	CILINDRO DE RUEDA	106315	IZQ	23.8 mm 15/16"		372
	86-96	CILINDRO MAESTRO	98895		28.5 mm 1-1/8"	4X2	297	
	99-01	CILINDRO MAESTRO	390426		1-1/4"	4X2 4X4	313	
	00-01	KIT DE PISTÓN Y REPUESTO FD	742325	DEL	54.0 mm 2-1/8"	CON CALIPER DE DOBLE PISTON		
	99-99	KIT DE PISTÓN Y REPUESTO FD	742351	DEL	74.6 mm 2-15/16"			

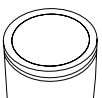

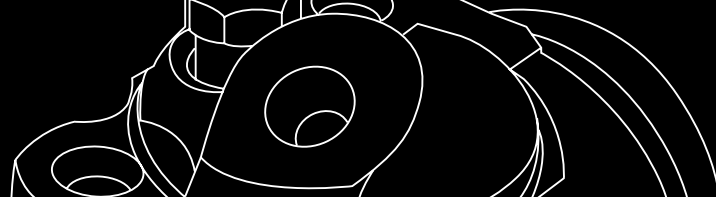

Modelo	Versión	Año	Descripción	Número Lusac	Posición	Diámetro	Notas	Foto Pág.
RAM CHARGER		86-96	KIT DE PISTÓN Y REPUESTO FD	742364	DEL	78.6 mm 3-3/32"		
		99-01	REP. CIL. MAESTRO Y DE CLUTCH	90426		31.7 mm 1-1/4"		559
		86-96	REP. CIL. MAESTRO Y DE CLUTCH	101928		28.5 mm 1-1/8"		560
		92-93	REPUESTO P/CILINDRO MAESTRO DE CLUTCH	730		22.2 mm 7/8"		556
		92-93	REPUESTO P/CILINDRO MAESTRO DE CLUTCH	735		25.4 mm 1"		557
RAM MAXI WAGON 3500		95-97	MANGUERA DE FRENOS	38200	DEL DER	23"		389
		00-01	MANGUERA DE FRENOS	38576	TRAS IZQ	21.88"		392
		95-99	MANGUERA DE FRENOS	38636	TRAS IZQ	22.13"		394
		95-97	MANGUERA DE FRENOS	380217	DEL IZQ	21"		409
		98-99	MANGUERA DE FRENOS	380340	DEL DER	18.75"		415
		00-01	MANGUERA DE FRENOS	380344	DEL DER	39.25"		415
		00-01	MANGUERA DE FRENOS	380541	DEL IZQ	32"		425
		98-99	MANGUERA DE FRENOS	380747	DEL IZQ	19.5"		427
		02-02	MANGUERA DE FRENOS	381160	DEL DER	18.75"		436
		02-02	MANGUERA DE FRENOS	381161	DEL IZQ	18.75"		436
		95-97	PISTÓN FRENO DE DISCO	76026	DEL	78.6 mm 3-3/32"		518
		98-02	PISTÓN FRENO DE DISCO	850300	DEL	55.9 mm 2-13/64"	CALIPER DOBLE PISTON	529
		98-02	REPUESTO FRENO DE DISCO	2154	DEL	55.9 mm 2-13/64"	CALIPER DOBLE PISTON	540
		95-97	REPUESTO FRENO DE DISCO	101491	DEL	78.6 mm 3-3/32"		554
		95-97	CILINDRO DE RUEDA	17507	IZQ	7/8"		364
		95-97	CILINDRO DE RUEDA	17508	DER	7/8"		364
		98-99	CILINDRO DE RUEDA	79767	DER	26.9 mm 1-1/16"		371
		98-99	CILINDRO DE RUEDA	79767	IZQ	26.9 mm 1-1/16"		371
		00-02	CILINDRO DE RUEDA	370077	DER	15/16"		375
		00-02	CILINDRO DE RUEDA	370077	IZQ	15/16"		375
	95-97	CILINDRO MAESTRO	39862		1-1/8"		295	
	98-02	CILINDRO MAESTRO	390516		1-1/4"		316	
	98-02	REP. CIL. MAESTRO Y DE CLUTCH	90516		31.7 mm 1-1/4"		559	
RAM RUNNERV		96-97	KIT DE PISTÓN Y REPUESTO FD	742351	DEL	74.6 mm 2-15/16"	10 V CALIPER SENCILLO	
		96-97	MANGUERA DE FRENOS	38636	TRAS DER	22.13"	10 V	394
		96-97	MANGUERA DE FRENOS	38636	TRAS IZQ	22.13"	10 V	394
		97-97	MANGUERA DE FRENOS	380303	DEL IZQ	19.5"	DS 10 V	412
		97-97	MANGUERA DE FRENOS	380342	DEL DER	19"	DS 10 V	415
		96-97	PISTÓN FRENO DE DISCO	85157	DEL	74.6 mm 2-15/16"	10 V	520
		96-97	REPUESTO FRENO DE DISCO	2005	DEL	74.6 mm 2-15/16"	10 V	538
		96-97	CILINDRO DE RUEDA	37985	DER	15/16"	10 V	369
		96-97	CILINDRO DE RUEDA	37985	IZQ	15/16"	10 V	369
		96-96	CILINDRO MAESTRO	390259		40mm & 1/8"	10 V	306
		97-97	CILINDRO MAESTRO	390426		1-1/4"	10 V	313
		97-97	REP. CIL. MAESTRO Y DE CLUTCH	90426		31.7 mm 1-1/4"	10 V	559
		96-96	REP. CIL. MAESTRO Y DE CLUTCH	104459		28.5 mm 1-1/8"	10 V	560
RAM SRT-10		05-06	CILINDRO DE RUEDA	79767	DER	26.9 mm 1-1/16"		371
		05-06	CILINDRO DE RUEDA	79767	IZQ	26.9 mm 1-1/16"		371
		05-06	MANGUERA DE FRENOS	38636	TRAS IZQ	22.13"		394





Modelo	Versión	Año	Descripción	Número Lusac	Posición	Diámetro	Notas	Foto Pág.
DODGE								
RAM SRT-10		05-06	MANGUERA DE FRENOS	380344	DEL DER	39.25"		415
		05-06	MANGUERA DE FRENOS	380541	DEL IZQ	32"		425
		05-06	PISTÓN FRENO DE DISCO	85206	DEL	86.1 mm 3-25/64"		521
		05-06	REPUESTO FRENO DE DISCO	2033	DEL	86.1 mm 3-25/64"		538
RAM VAN	1500	99-02	CILINDRO DE RUEDA	78974	IZQ	25.4 mm 1"		370
	1500	99-02	CILINDRO DE RUEDA	78975	DER	25.4 mm 1"		371
	1500	97-03	CILINDRO DE RUEDA	370077	TRAS IZQ DER	15/16"		375
	1500	98-03	CILINDRO MAESTRO	390516		1-1/4"		316
	1500	98-02	MANGUERA DE FRENOS	381160	DER	18.75"		436
	1500	98-02	MANGUERA DE FRENOS	381161	IZQ	18.75"	C/ABS EN RUEDAS TRASERAS	436
	2500	99-02	CILINDRO DE RUEDA	78974	IZQ	25.4 mm 1"		370
	2500	99-02	CILINDRO DE RUEDA	78975	DER	25.4 mm 1"		371
	2500	98-03	CILINDRO DE RUEDA	370077	TRAS IZQ DER	15/16"		375
	2500	98-03	CILINDRO MAESTRO	390516		1-1/4"		316
	2500	98-02	MANGUERA DE FRENOS	381160	DER	18.75"		436
	2500	98-02	MANGUERA DE FRENOS	381161	IZQ	18.75"	C/ABS EN RUEDAS TRASERAS	436
	1500	95-97	MANGUERA DE FRENOS	38082	TRAS DER	25.38"		389
	1500	95-97	MANGUERA DE FRENOS	38197	TRAS IZQ	23"		389
	1500	95-97	MANGUERA DE FRENOS	38200	DEL DER	23"		389
	1500	95-97	MANGUERA DE FRENOS	380217	DEL IZQ	21"		409
	1500	98-03	MANGUERA DE FRENOS	381160	DEL DER	18.75"		436
	1500	98-03	MANGUERA DE FRENOS	381161	DEL IZQ	18.75"	DS TAMBIÉN PUEDE LLEVAR LA MANGERA DEL IZQ 382304 Y DEL DER 382305 00-01	436
	1500	95-97	PISTÓN FRENO DE DISCO	76026	DEL	78.6 mm 3-3/32"		518
	1500	98-03	PISTÓN FRENO DE DISCO	107534	DEL Y TRAS	54.0 mm 2-1/8"	CALIPER DOBLE PISTON	528
	1500	02-03	REPUESTO FRENO DE DISCO	2473	TRAS	54.0 mm 2-1/8"		541
	1500	95-97	REPUESTO FRENO DE DISCO	101491	DEL	78.6 mm 3-3/32"		554
	1500	98-03	REPUESTO FRENO DE DISCO	102443	DEL	54.0 mm 2-1/8"	CALIPER DOBLE PISTON	554
	1500	98-03	CILINDRO DE RUEDA	78974	IZQ	25.4 mm 1"		370
	1500	98-03	CILINDRO DE RUEDA	78975	DER	25.4 mm 1"		371
	1500	95-97	CILINDRO DE RUEDA	106315	DER	23.8 mm 15/16"		372
	1500	95-97	CILINDRO DE RUEDA	106315	IZQ	23.8 mm 15/16"		372
	1500	95-95	CILINDRO MAESTRO	98895		28.5 mm 1-1/8"		297
1500	96-03	CILINDRO MAESTRO	390516		1-1/4"		316	
1500	02-03	KIT DE PISTÓN Y REPUESTO FD	742325	DEL	54.0 mm 2-1/8"	CALIPER SENCILLO		
1500	98-03	KIT DE PISTÓN Y REPUESTO FD	742325	DEL	54.0 mm 2-1/8"	CON CALIPER DE DOBLE PISTON		
1500	02-03	KIT DE PISTÓN Y REPUESTO FD	742326	TRAS	54.0 mm 2-1/8"			
RAM VAN	1500	95-97	KIT DE PISTÓN Y REPUESTO FD	742364	DEL	78.6 mm 3-3/32"		
	1500	98-03	REP. CIL. MAESTRO Y DE CLUTCH	90516		31.7 mm 1-1/4"		559
	1500	95-95	REP. CIL. MAESTRO Y DE CLUTCH	101928		28.5 mm 1-1/8"		560

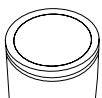



Modelo	Versión	Año	Descripción	Número Lusac	Posición	Diámetro	Notas	Foto Pág.	
RAM VAN	2500	96-97	MANGUERA DE FRENOS	38082	TRAS DER	25.38"		389	
	2500	96-97	MANGUERA DE FRENOS	38197	TRAS IZQ	23"		389	
	2500	96-97	MANGUERA DE FRENOS	38200	DEL DER	23"		389	
	2500	96-97	MANGUERA DE FRENOS	380217	DEL IZQ	21"		409	
	2500	98-02	MANGUERA DE FRENOS	381160	DEL DER	18.75"		436	
	2500	98-02	MANGUERA DE FRENOS	381161	DEL IZQ	18.75"		436	
	2500	96-97	PISTÓN FRENO DE DISCO	76026	DEL	78.6 mm 3-3/32"		518	
	2500	98-02	PISTÓN FRENO DE DISCO	107534	DEL	54.0 mm 2-1/8"	CALIPER DOBLE PISTON	528	
	2500	96-97	REPUESTO FRENO DE DISCO	101491	DEL	78.6 mm 3-3/32"		554	
	2500	98-02	REPUESTO FRENO DE DISCO	102443	DEL	54.0 mm 2-1/8"	CALIPER DOBLE PISTON	554	
	2500	98-02	CILINDRO DE RUEDA	78974	IZQ	25.4 mm 1"		370	
	2500	98-02	CILINDRO DE RUEDA	78975	DER	25.4 mm 1"		371	
	2500	96-97	CILINDRO DE RUEDA	106315	DER	23.8 mm 15/16"		372	
	2500	96-97	CILINDRO DE RUEDA	106315	IZQ	23.8 mm 15/16"		372	
	2500	96-02	CILINDRO MAESTRO	390516		1-1/4"		316	
	2500	98-02	KIT DE PISTÓN Y REPUESTO FD	742325	DEL	54.0 mm 2-1/8"	CON CALIPER DE DOBLE PISTON		
	2500	96-97	KIT DE PISTÓN Y REPUESTO FD	742364	DEL	78.6 mm 3-3/32"			
	2500	96-02	REP. CIL. MAESTRO Y DE CLUTCH	90516		31.7 mm 1-1/4"		559	
	3500	95-97	MANGUERA DE FRENOS	38200	DEL DER	23"		389	
	3500	00-01	MANGUERA DE FRENOS	38576	TRAS IZQ	21.88"		392	
	3500	95-99	MANGUERA DE FRENOS	38636	TRAS IZQ	22.13"		394	
	3500	95-97	MANGUERA DE FRENOS	380217	DEL IZQ	21"		409	
	3500	98-99	MANGUERA DE FRENOS	380340	DEL DER	18.75"		415	
	3500	00-01	MANGUERA DE FRENOS	380344	DEL DER	39.25"		415	
	3500	00-01	MANGUERA DE FRENOS	380541	DEL IZQ	32"		425	
	3500	98-99	MANGUERA DE FRENOS	380747	DEL IZQ	19.5"		427	
	3500	02-02	MANGUERA DE FRENOS	381160	DEL DER	18.75"		436	
	3500	02-02	MANGUERA DE FRENOS	381161	DEL IZQ	18.75"		436	
	3500	95-97	PISTÓN FRENO DE DISCO	76026	DEL	78.6 mm 3-3/32"		518	
	3500	98-02	PISTÓN FRENO DE DISCO	850300	DEL	55.9 mm 2-13/64"	CALIPER DOBLE PISTON	529	
	3500	98-02	REPUESTO FRENO DE DISCO	2154	DEL	55.9 mm 2-13/64"	CALIPER DOBLE PISTON	540	
	3500	95-97	REPUESTO FRENO DE DISCO	101491	DEL	78.6 mm 3-3/32"		554	
	3500	95-97	CILINDRO DE RUEDA	17507	IZQ	7/8"		364	
	3500	95-97	CILINDRO DE RUEDA	17508	DER	7/8"		364	
	3500	98-99	CILINDRO DE RUEDA	79767	DER	26.9 mm 1-1/16"		371	
	3500	98-99	CILINDRO DE RUEDA	79767	IZQ	26.9 mm 1-1/16"		371	
	3500	00-02	CILINDRO DE RUEDA	370077	DER	15/16"		375	
	3500	00-02	CILINDRO DE RUEDA	370077	IZQ	15/16"		375	
	3500	95-97	CILINDRO MAESTRO	39862		1-1/8"		295	
	3500	98-02	CILINDRO MAESTRO	390516		1-1/4"		316	
	3500	98-02	KIT DE PISTÓN Y REPUESTO FD	742337	DEL	55.9 mm 2-13/64"			
	3500	96-97	KIT DE PISTÓN Y REPUESTO FD	742364	DEL	78.6 mm 3-3/32"			
	3500	98-02	REP. CIL. MAESTRO Y DE CLUTCH	90516		31.7 mm 1-1/4"		559	
	RAM WAGON	1500	99-02	CILINDRO DE RUEDA	78974	IZQ	25.4 mm 1"		370





Modelo	Versión	Año	Descripción	Número Lusac	Posición	Diámetro	Notas	Foto Pág.
DODGE								
RAM WAGON	1500	99-02	CILINDRO DE RUEDA	78975	DER	25.4 mm 1"		371
	1500	97-02	CILINDRO DE RUEDA	370077	TRAS IZQ DER	15/16"		375
	1500	98-02	CILINDRO MAESTRO	390516		1-1/4"		316
	1500	98-02	MANGUERA DE FRENOS	381160	DER	18.75"		436
	1500	98-02	MANGUERA DE FRENOS	381161	IZQ	18.75"	C/ABS EN RUE- DAS TRASERAS	436
	2500	99-02	CILINDRO DE RUEDA	78974	IZQ	25.4 mm 1"		370
	2500	99-02	CILINDRO DE RUEDA	78975	DER	25.4 mm 1"		371
	2500	98-02	CILINDRO DE RUEDA	370077	TRAS IZQ DER	15/16"		375
	2500	98-02	CILINDRO MAESTRO	390516		1-1/4"		316
	2500	98-02	MANGUERA DE FRENOS	381160	DER	18.75"		436
	2500	98-02	MANGUERA DE FRENOS	381161	IZQ	18.75"	C/ABS EN RUE- DAS TRASERAS	436
	1500	95-97	MANGUERA DE FRENOS	38082	TRAS DER	25.38"		389
	1500	95-97	MANGUERA DE FRENOS	38197	TRAS IZQ	23"		389
	1500	95-97	MANGUERA DE FRENOS	38200	DEL DER	23"		389
	1500	95-97	MANGUERA DE FRENOS	380217	DEL IZQ	21"		409
	1500	98-03	MANGUERA DE FRENOS	381160	DEL DER	18.75"		436
	1500	98-03	MANGUERA DE FRENOS	381161	DEL IZQ	18.75"	DS TAMBIÉN PUEDE LLEVAR LA MANGERA DEL IZQ 382304 Y DEL DER 382305 00-01	436
	1500	95-97	PISTÓN FRENO DE DISCO	76026	DEL	78.6 mm 3-3/32"		518
	1500	98-03	PISTÓN FRENO DE DISCO	107534	DEL	54.0 mm 2-1/8"		528
	1500	02-03	REPUESTO FRENO DE DISCO	2473	TRAS	54.0 mm 2-1/8"		541
	1500	95-97	REPUESTO FRENO DE DISCO	101491	DEL	78.6 mm 3-3/32"		554
	1500	98-03	REPUESTO FRENO DE DISCO	102443	DEL	54.0 mm 2-1/8"	CALIPER DOBLE PISTON	554
	1500	98-03	CILINDRO DE RUEDA	78974	IZQ	25.4 mm 1"		370
	1500	98-03	CILINDRO DE RUEDA	78975	DER	25.4 mm 1"		371
	1500	95-97	CILINDRO DE RUEDA	106315	DER	23.8 mm 15/16"		372
	1500	95-97	CILINDRO DE RUEDA	106315	IZQ	23.8 mm 15/16"		372
	1500	95-95	CILINDRO MAESTRO	98895		28.5 mm 1-1/8"		297
	1500	96-03	CILINDRO MAESTRO	390516		1-1/4"		316
	1500	02-03	KIT DE PISTÓN Y REPUESTO FD	742325	DEL	54.0 mm 2-1/8"	CALIPER SENCILLO	
	1500	98-03	KIT DE PISTÓN Y REPUESTO FD	742325	DEL	54.0 mm 2-1/8"	CON CALIPER DE DOBLE PISTON	
	1500	02-03	KIT DE PISTÓN Y REPUESTO FD	742326	TRAS	54.0 mm 2-1/8"		
	1500	95-97	KIT DE PISTÓN Y REPUESTO FD	742364	DEL	78.6 mm 3-3/32"		
	1500	98-03	REP. CIL. MAESTRO Y DE CLUTCH	90516		31.7 mm 1-1/4"		559
	1500	95-95	REP. CIL. MAESTRO Y DE CLUTCH	101928		28.5 mm 1-1/8"		560
	2500	96-97	MANGUERA DE FRENOS	38082	TRAS DER	25.38"		389
	2500	96-97	MANGUERA DE FRENOS	38197	TRAS IZQ	23"		389
	2500	96-97	MANGUERA DE FRENOS	38200	DEL DER	23"		389
	2500	96-97	MANGUERA DE FRENOS	380217	DEL IZQ	21"		409
	2500	98-02	MANGUERA DE FRENOS	381160	DEL DER	18.75"		436
	2500	98-02	MANGUERA DE FRENOS	381161	DEL IZQ	18.75"		436

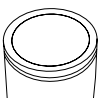



Modelo	Versión	Año	Descripción	Número Lusac	Posición	Diámetro	Notas	Foto Pág.
RAM WAGON	2500	96-97	PISTÓN FRENO DE DISCO	76026	DEL	78.6 mm 3-3/32"		518
	2500	98-02	PISTÓN FRENO DE DISCO	107534	DEL	54.0 mm 2-1/8"	CALIPER DOBLE PISTON	528
	2500	96-97	REPUESTO FRENO DE DISCO	101491	DEL	78.6 mm 3-3/32"		554
	2500	98-02	REPUESTO FRENO DE DISCO	102443	DEL	54.0 mm 2-1/8"	CALIPER DOBLE PISTON	554
	2500	98-02	CILINDRO DE RUEDA	78974	IZQ	25.4 mm 1"		370
	2500	98-02	CILINDRO DE RUEDA	78975	DER	25.4 mm 1"		371
	2500	96-97	CILINDRO DE RUEDA	106315	DER	23.8 mm 15/16"		372
	2500	96-97	CILINDRO DE RUEDA	106315	IZQ	23.8 mm 15/16"		372
	2500	96-02	CILINDRO MAESTRO	390516		1-1/4"		316
	2500	98-02	KIT DE PISTÓN Y REPUESTO FD	742325	DEL	54.0 mm 2-1/8"	CON CALIPER DE DOBLE PISTON	
	2500	96-97	KIT DE PISTÓN Y REPUESTO FD	742364	DEL	78.6 mm 3-3/32"		
	2500	96-02	REP. CIL. MAESTRO Y DE CLUTCH	90516		31.7 mm 1-1/4"		559
	3500	98-02	KIT DE PISTÓN Y REPUESTO FD	742337	DEL	55.9 mm 2-13/64"		
	3500	96-97	KIT DE PISTÓN Y REPUESTO FD	742364	DEL	78.6 mm 3-3/32"		
SERIE	600K	84-85	CILINDRO DE RUEDA	107475	DER	14.2 mm 9/16"		372
	600K	84-85	CILINDRO DE RUEDA	107475	IZQ	14.2 mm 9/16"		372
	600K	84-85	CILINDRO DE RUEDA	107476	DER	15.8 mm 5/8"		372
	600K	84-85	CILINDRO DE RUEDA	107476	IZQ	15.8 mm 5/8"		372
	600K	84-85	CILINDRO MAESTRO	108134		21.0 mm		297
	600K	84-85	MANGUERA DE FRENOS	4072	DEL DER	21 1/4"		386
	600K	84-85	MANGUERA DE FRENOS	4073	DEL IZQ	21 1/4"		386
	600K	84-85	MANGUERA DE FRENOS	38064	TRAS DER	8.25"		388
	600K	84-85	MANGUERA DE FRENOS	38064	TRAS IZQ	8.25"		388
	600K	84-85	PISTÓN FRENO DE DISCO	107534	DEL	54.0 mm 2-1/8"		528
	600K	84-85	REPUESTO CILINDRO DE RUEDA	112115		21.0 mm 53/64"		561
	600K	84-85	REPUESTO FRENO DE DISCO	102443	DEL	54.0 mm 2-1/8"		554
	SERIE 600		84-85	KIT DE PISTÓN Y REPUESTO FD	742325	DEL	54.0 mm 2-1/8"	CON CALIPER DE DOBLE PISTON
SHADOW		89-89	MANGUERA DE FRENOS	4072	DEL DER	21 1/4"		386
		89-89	MANGUERA DE FRENOS	4073	DEL IZQ	21 1/4"		386
		89-89	MANGUERA DE FRENOS	38064	TRAS DER	8.25"		388
		89-89	MANGUERA DE FRENOS	38064	TRAS IZQ	8.25"		388
		90-94	MANGUERA DE FRENOS	38646	TRAS DER	9.38"		395
		90-94	MANGUERA DE FRENOS	38646	TRAS IZQ	9.38"		395
		90-90	MANGUERA DE FRENOS	380071	DEL DER	23"		406
		90-90	MANGUERA DE FRENOS	380072	DEL IZQ	22.75"		406
		91-94	MANGUERA DE FRENOS	380073	DEL DER	22.75"		406
		91-94	MANGUERA DE FRENOS	380074	DEL IZQ	22.5"		406
		89-94	PISTÓN FRENO DE DISCO	107534	DEL	54.0 mm 2-1/8"		528
		89-94	REPUESTO FRENO DE DISCO	102443	DEL	54.0 mm 2-1/8"	CALIPER KH	554
	GTS TURBO	89-89	CILINDRO DE RUEDA	107476	DER	15.8 mm 5/8"		372
	GTS TURBO	89-89	CILINDRO DE RUEDA	107476	IZQ	15.8 mm 5/8"		372
	GTS TURBO	89-89	CILINDRO MAESTRO	39736		7/8"		295
GTS TURBO	89-89	MANGUERA DE FRENOS	4072	DEL DER	21 1/4"		386	





Modelo	Versión	Año	Descripción	Número Lusac	Posición	Diámetro	Notas	Foto Pág.
DODGE								
SHADOW	GTS TURBO	89-89	MANGUERA DE FRENOS	4073	DEL IZQ	21 1/4"		386
	GTS TURBO	89-89	MANGUERA DE FRENOS	38064	TRAS DER	8.25"		388
	GTS TURBO	89-89	MANGUERA DE FRENOS	38064	TRAS IZQ	8.25"		388
	GTS TURBO	89-89	MANGUERA DE FRENOS	38604	TRAS DER	6.88"		392
	GTS TURBO	89-89	MANGUERA DE FRENOS	38604	TRAS IZQ	6.88"		392
	GTS TURBO	89-89	PISTÓN FRENO DE DISCO	107534	DEL	54.0 mm 2-1/8"		528
	GTS TURBO	89-89	PISTÓN FRENO DE DISCO	119043	TRAS	34.9 mm 1-3/8"		529
	GTS TURBO	89-89	REP. CIL. MAESTRO Y DE CLUTCH	116612		22.2 mm 7/8"		561
	GTS TURBO	89-89	REPUESTO FRENO DE DISCO	102443	DEL	54.0 mm 2-1/8"		554
	GTS TURBO	89-89	REPUESTO FRENO DE DISCO	118265	TRAS	34.1 mm 1-11/32"		554
		89-94	CILINDRO DE RUEDA	107476	DER	15.8 mm 5/8"		372
		89-94	CILINDRO DE RUEDA	107476	IZQ	15.8 mm 5/8"		372
		89-94	CILINDRO MAESTRO	108134		21.0 mm		297
		89-94	KIT DE PISTÓN Y REPUESTO FD	742325	DEL	54.0 mm 2-1/8"	CON CALIPER DE DOBLE PISTON	
	89-94	REPUESTO CILINDRO DE RUEDA	112115		21.0 mm 53/64"		561	
SPIRIT		90-90	MANGUERA DE FRENOS	4072	DEL DER	21 1/4"		386
		90-90	MANGUERA DE FRENOS	4073	DEL IZQ	21 1/4"		386
		90-95	MANGUERA DE FRENOS	38646	TRAS DER	9.38"		395
		90-95	MANGUERA DE FRENOS	38646	TRAS IZQ	9.38"		395
		91-95	MANGUERA DE FRENOS	380073	DEL DER	22.75"		406
		91-95	MANGUERA DE FRENOS	380074	DEL IZQ	22.5"		406
		90-95	PISTÓN FRENO DE DISCO	107534	DEL	54.0 mm 2-1/8"		528
		90-95	REPUESTO FRENO DE DISCO	102443	DEL	54.0 mm 2-1/8"		554
	R/T	91-95	CILINDRO MAESTRO	108168		24.0 mm		297
	R/T	91-95	MANGUERA DE FRENOS	38604	TRAS DER	6.88"		392
	R/T	91-95	MANGUERA DE FRENOS	38604	TRAS IZQ	6.88"		392
	R/T	91-95	MANGUERA DE FRENOS	380073	DEL DER	22.75"		406
	R/T	91-95	MANGUERA DE FRENOS	380074	DEL IZQ	22.5"		406
	R/T	91-95	PISTÓN FRENO DE DISCO	108159	DEL	60.0 mm		528
	R/T	91-95	PISTÓN FRENO DE DISCO	119043	TRAS	34.9 mm 1-3/8"		529
	R/T	91-95	REP. CIL. MAESTRO Y DE CLUTCH	112246		24.0 mm		561
	R/T	91-95	REPUESTO FRENO DE DISCO	108241	DEL	60.0 mm		554
	R/T	91-95	REPUESTO FRENO DE DISCO	118265	TRAS	34.1 mm 1-11/32"		554
		90-95	CILINDRO DE RUEDA	37864	DER	15.8 mm 5/8"		368
		90-95	CILINDRO DE RUEDA	37864	IZQ	15.8 mm 5/8"		368
		90-95	CILINDRO MAESTRO	39736		7/8"		295
		91-95	KIT DE PISTÓN Y REPUESTO FD	742324	DEL	60.0 mm		
		90-95	KIT DE PISTÓN Y REPUESTO FD	742325	DEL	54.0 mm 2-1/8"	CON CALIPER DE DOBLE PISTON	
	90-95	REP. CIL. MAESTRO Y DE CLUTCH	116612		22.2 mm 7/8"		561	

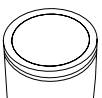



Modelo	Versión	Año	Descripción	Número Lusac	Posición	Diámetro	Notas	Foto Pág.
STRATUS v		98-06	MANGUERA DE FRENOS	38328	TRAS DER	10.5"	DS SI ES TAMBOR ATRÁS PUEDE LLEVAR LAS MANGUERAS 382351 Y 382352	390
		98-06	MANGUERA DE FRENOS	38328	TRAS IZQ	10.5"		390
		95-00	MANGUERA DE FRENOS	380304	DEL IZQ	14.63"		412
		95-00	MANGUERA DE FRENOS	380304	TRAS IZQ	14.63"		412
		95-02	MANGUERA DE FRENOS	380305	DEL DER	17.75"		412
		95-02	MANGUERA DE FRENOS	380306	DEL IZQ	18.38"		412
		95-00	MANGUERA DE FRENOS	380307	TRAS DER	18.38"		412
		95-00	MANGUERA DE FRENOS	380308	TRAS IZQ	14.13"		412
		95-00	MANGUERA DE FRENOS	380309	DEL DER	16.13"		412
		95-00	MANGUERA DE FRENOS	380309	TRAS DER	16.13"		412
		98-02	MANGUERA DE FRENOS	380978	TRAS DER	22.75"		430
		98-02	MANGUERA DE FRENOS	380978	TRAS IZQ	22.75"		430
		98-05	PISTÓN FRENO DE DISCO	85163	TRAS	36.1 mm 1-27/64"		520
		95-00	PISTÓN FRENO DE DISCO	85469	DEL	54.0 mm 2-1/8"		524
		98-06	PISTÓN FRENO DE DISCO	85470	DEL	60.3 mm 2-3/8"		524
		95-06	PISTÓN FRENO DE DISCO	119043	TRAS	34.9 mm 1-3/8"		529
		98-05	REPUESTO FRENO DE DISCO	1962	TRAS	36.1 mm 1-27/64"		
		98-06	REPUESTO FRENO DE DISCO	2470	DEL	60.3 mm 2-3/8"		
		95-00	REPUESTO FRENO DE DISCO	2845	DEL	54.0 mm 2-1/8"		544
		95-06	REPUESTO FRENO DE DISCO	118265	TRAS	34.1 mm 1-11/32"		554
		01-05	CILINDRO DE RUEDA	37376	TRAS IZQ DER	3/4"	2 PTAS COUPE	365
		95-00	CILINDRO DE RUEDA	37970	DER	3/4"		369
		95-00	CILINDRO DE RUEDA	37970	IZQ	3/4"		369
		95-00	CILINDRO DE RUEDA	3700905	DER	19.0 mm 3/4"		383
		95-00	CILINDRO DE RUEDA	3700905	IZQ	19.0 mm 3/4"		383
		95-02	CILINDRO MAESTRO	390251		7/8"	S/ABS	305
		96-97	CILINDRO MAESTRO	390254		7/8"	C/ABS	305
		98-02	CILINDRO MAESTRO	390425		7/8"	C/ABS	313
		02-05	CILINDRO MAESTRO	390660		1-1/16"	S/C DE TRACCIÓN C/ABS	322
		03-06	CILINDRO MAESTRO	390661		1-1/16"	S/ABS	322
		03-06	CILINDRO MAESTRO	390816		15/16"		330
		98-02	CILINDRO MAESTRO	475431		26.9 mm 1-1/16"	C/ABS	358
		98-02	CILINDRO MAESTRO	475973		26.9 mm 1-1/16"	S/ABS	358
	02-04	CILINDRO MAESTRO	05019401		25.4 mm 1"		359	
	95-02	REP. CIL. MAESTRO Y DE CLUTCH	90251		22.2 mm 7/8"		558	
VERNA		04-06	PISTÓN FRENO DE DISCO	85209	DEL	54.0 mm 2-1/8"		521
		04-06	REPUESTO FRENO DE DISCO	2020	DEL	54.0 mm 2-1/8"		538
		04-06	CILINDRO DE RUEDA	370018RL	DER	17.8 mm 45/64"		
		04-06	CILINDRO DE RUEDA	370018RL	IZQ	17.8 mm 45/64"		
		04-06	CILINDRO MAESTRO	390724		7/8"		324
		04-06	CILINDRO MAESTRO	39009901		22.2 mm 7/8"		360





Modelo	Versión	Año	Descripción	Número Lusac	Posición	Diámetro	Notas	Foto Pág.
DODGE								
VIPER		93-93	CILINDRO MAESTRO	390096		1-1/16"		300
		04-10	CILINDRO MAESTRO	390508		15/16"		316
VOLARE K		85-88	MANGUERA DE FRENOS	4072	DEL DER	21 1/4"		386
		85-88	MANGUERA DE FRENOS	4073	DEL IZQ	21 1/4"		386
		85-88	MANGUERA DE FRENOS	38064	TRAS DER	8.25"		388
		85-88	MANGUERA DE FRENOS	38064	TRAS IZQ	8.25"		388
		85-88	PISTÓN FRENO DE DISCO	107534	DEL	54.0 mm 2-1/8"		528
		85-88	REPUESTO FRENO DE DISCO	102443	DEL	54.0 mm 2-1/8"		554
		85-88	CILINDRO DE RUEDA	107475	DER	14.2 mm 9/16"		372
		85-88	CILINDRO DE RUEDA	107475	IZQ	14.2 mm 9/16"		372
		85-88	CILINDRO DE RUEDA	107476	DER	15.8 mm 5/8"		372
		85-88	CILINDRO DE RUEDA	107476	IZQ	15.8 mm 5/8"		372
		85-88	CILINDRO MAESTRO	108134		21.0 mm		297
		85-88	REPUESTO CILINDRO DE RUEDA	112115		21.0 mm 53/64"		561
	W-150		85-87	MANGUERA DE FRENOS	38243	TRAS DER	26.13"	
		85-87	MANGUERA DE FRENOS	38243	TRAS IZQ	26.13"		389
		85-87	MANGUERA DE FRENOS	38421	DEL DER	10.19"		391
		85-87	MANGUERA DE FRENOS	38421	DEL IZQ	10.19"		391
		85-87	PISTÓN FRENO DE DISCO	76021	DEL	78.6 mm 3-3/32"		518
		85-87	REPUESTO FRENO DE DISCO	101491	DEL	78.6 mm 3-3/32"		554
		85-87	CILINDRO DE RUEDA	106315	DER	23.8 mm 15/16"		372
		85-87	CILINDRO DE RUEDA	106315	IZQ	23.8 mm 15/16"		372
		85-87	CILINDRO MAESTRO	98895		28.5 mm 1-1/8"	4X4	297
		85-87	REP. CIL. MAESTRO Y DE CLUTCH	101928		28.5 mm 1-1/8"		560
W-250		89-93	MANGUERA DE FRENOS	38050	DEL IZQ	12"	4X4	388
		86-93	MANGUERA DE FRENOS	38243	TRAS IZQ	26.13"	4X4	389
		86-88	MANGUERA DE FRENOS	38244	DEL DER	12.44"	4X4	389
		86-88	MANGUERA DE FRENOS	38244	DEL IZQ	12.44"	4X4	389
		86-88	MANGUERA DE FRENOS	38421	DEL DER	10.19"	4X4	391
		86-88	MANGUERA DE FRENOS	38421	DEL IZQ	10.19"	4X4	391
		86-93	PISTÓN FRENO DE DISCO	76021	DEL	78.6 mm 3-3/32"	4X4	518
		86-93	REPUESTO FRENO DE DISCO	101491	DEL	78.6 mm 3-3/32"	4X4	554
		86-93	CILINDRO DE RUEDA	17507	IZQ	7/8"	4X4	364
		86-93	CILINDRO DE RUEDA	17508	DER	7/8"	4X4	364
		89-93	CILINDRO DE RUEDA	78974	IZQ	25.4 mm 1"	4X4	370
		89-93	CILINDRO DE RUEDA	78975	DER	25.4 mm 1"	4X4	371
		89-93	CILINDRO DE RUEDA	106315	DER	23.8 mm 15/16"	4X4	372
		89-93	CILINDRO DE RUEDA	106315	IZQ	23.8 mm 15/16"	4X4	372
		86-88	CILINDRO MAESTRO	98895		28.5 mm 1-1/8"	4X4	297
		86-93	CILINDRO MAESTRO	98896		28.5 mm 1-1/8"	4X4	297
		86-93	REP. CIL. MAESTRO Y DE CLUTCH	86626		28.5 mm 1-1/8"		558
		86-88	REP. CIL. MAESTRO Y DE CLUTCH	101928		28.5 mm 1-1/8"		560
EAGLE								
2000 GTX		90-93	CILINDRO DE RUEDA	37969	TRAS IZQ DER	19.0 mm 3/4"	CANADA USA	369
TALON		95-99	CILINDRO DE CLUTCH	350087		15.8 mm 5/8"	CHOCOLATE	
FIAT								
PALIO		04-11	CILINDRO DE RUEDA	3700900	DER	19.0 mm 3/4"		383



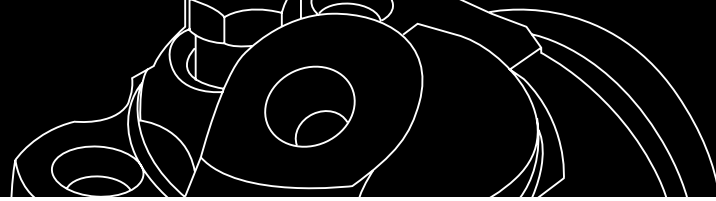

Modelo	Versión	Año	Descripción	Número Lusac	Posición	Diámetro	Notas	Foto Pág.
PALIO		04-11	CILINDRO DE RUEDA	3700900	IZQ	19.0 mm 3/4"		383
		04-11	KIT DE PISTÓN Y REPUESTO FD	742387	DEL	54.0 mm 2-1/8"		
		04-11	PISTÓN FRENO DE DISCO	85812	DEL	54.0 mm 2-1/8"		526
		04-11	REPUESTO FRENO DE DISCO	1449	DEL	54.0 mm 2-1/8"		537
FORD								
AEROSTAR		91-95	MANGUERA DE FRENOS	38814	DEL IZQ	14.19"		398
		91-95	MANGUERA DE FRENOS	38815	DEL DER	14.19"		398
		91-95	PISTÓN FRENO DE DISCO	85055	DEL	66.7 mm 2-5/8"		519
		91-95	REPUESTO FRENO DE DISCO	1565	DEL	66.7 mm 2-5/8"		537
		92-92	CILINDRO DE CLUTCH	350034		19.09 mm		
		91-91	CILINDRO DE CLUTCH	350041		19.0 mm 3/4"	NACIONAL	
		93-95	CILINDRO DE CLUTCH	360016		N/R		
		91-93	CILINDRO DE RUEDA	37856	DER	7/8"		367
		91-93	CILINDRO DE RUEDA	37856	IZQ	7/8"		367
		94-95	CILINDRO DE RUEDA	37999	DER	15/16"		370
		94-95	CILINDRO DE RUEDA	37999	IZQ	15/16"		370
		92-95	CILINDRO MAESTRO	390096		1-1/16"		300
		91-91	CILINDRO MAESTRO	390216		1-1/16"		304
B-600		91-95	KIT DE PISTÓN Y REPUESTO FD	742328	DEL	66.7 mm 2-5/8"		
		84-88	CILINDRO DE RUEDA	26159	DER	38.1 mm 1-1/2"	INFERIOR	
		84-88	CILINDRO DE RUEDA	26159	DER	38.1 mm 1-1/2"	SUPERIOR	
		84-88	CILINDRO DE RUEDA	26159	IZQ	38.1 mm 1-1/2"	INFERIOR	
		84-88	CILINDRO DE RUEDA	26159	IZQ	38.1 mm 1-1/2"	SUPERIOR	
		80-88	CILINDRO DE RUEDA	43375	IZQ	28.5 mm 1-1/8"	INFERIOR	
		80-88	CILINDRO DE RUEDA	43376	DER	28.5 mm 1-1/8"	INFERIOR	
		80-85	CILINDRO DE RUEDA	55890	IZQ	27.7 mm 1-3/32"		
		80-85	CILINDRO DE RUEDA	55891	DER	27.7 mm 1-3/32"		
		84-88	CILINDRO DE RUEDA	71238	DER	41.3 mm 1-5/8"	INFERIOR	
		84-88	CILINDRO DE RUEDA	71238	DER	41.3 mm 1-5/8"	SUPERIOR	
		84-88	CILINDRO DE RUEDA	71238	IZQ	41.3 mm 1-5/8"	INFERIOR	
		84-88	CILINDRO DE RUEDA	71238	IZQ	41.3 mm 1-5/8"	SUPERIOR	
		80-88	CILINDRO DE RUEDA	73500	IZQ	28.5 mm 1-1/8"	SUPERIOR	
		80-85	CILINDRO DE RUEDA	78743	DER	38.1 mm 1-1/2"	INFERIOR	
		80-85	CILINDRO DE RUEDA	78743	DER	38.1 mm 1-1/2"	SUPERIOR	
		80-85	CILINDRO DE RUEDA	78743	IZQ	38.1 mm 1-1/2"	INFERIOR	
		80-85	CILINDRO DE RUEDA	78743	IZQ	38.1 mm 1-1/2"	SUPERIOR	
		80-85	CILINDRO DE RUEDA	103223	IZQ	27.7 mm 1-3/32"		
		80-85	CILINDRO DE RUEDA	103224	DER	27.7 mm 1-3/32"		
		80-85	CILINDRO MAESTRO	103254		38.1 mm 1-1/2"		
		84-88	CILINDRO MAESTRO	116702		44.4 mm 1-3/4"		
		80-85	MANGUERA DE FRENOS	1178	DEL IZQ	25 1/8"		
	80-85	MANGUERA DE FRENOS	1185M	DEL IZQ	25 1/8"			
	80-85	REP. CIL. MAESTRO Y DE CLUTCH	103255		38.1 mm 1-1/2"			
BRONCO		93-98	CILINDRO DE CLUTCH	350032	SUP	18.0 mm	CHOCOLATE	
		92-92	CILINDRO DE CLUTCH	350033	SUP	22.2 mm 7/8"	CHOCOLATE	
		88-90	CILINDRO DE CLUTCH	350041		19.0 mm 3/4"		
		93-96	CILINDRO DE CLUTCH	360016		N/R		
		94-96	MANGUERA DE FRENOS	380319	DEL DER	22.75"	CHOCOLATE	413
		94-96	MANGUERA DE FRENOS	380320	DEL IZQ	21.5"	CHOCOLATE	413





Modelo	Versión	Año	Descripción	Número Lusac	Posición	Diámetro	Notas	Foto Pág.
FORD								
CLUB WAGON	E-150	95-96	CILINDRO DE RUEDA	59240	IZQ	23.8 mm 15/16"		370
	E-150	95-96	CILINDRO DE RUEDA	59241	DER	23.8 mm 15/16"		370
	E-150	97-03	CILINDRO DE RUEDA	78974	IZQ	25.4 mm 1"		370
	E-150	97-03	CILINDRO DE RUEDA	78975	DER	25.4 mm 1"		371
	E-150	95-05	MANGUERA DE FRENOS	380323	DEL IZQ	20.75"		413
	E-150	95-05	MANGUERA DE FRENOS	380324	DEL DER	22.75"		413
	E-150	95-98	MANGUERA DE FRENOS	380356	DEL IZQ	21.5"		416
	E-150	95-05	MANGUERA DE FRENOS	380385	TRAS IZQ	18"		418
	E-150	95-03	PISTÓN FRENO DE DISCO	85019	DEL	73.0 mm 2-7/8"		518
	E-150	95-03	REPUESTO FRENO DE DISCO	1838	DEL	73.0 mm 2-7/8"		538
	E-250	97-04	CILINDRO DE RUEDA	78974	IZQ	25.4 mm 1"		370
	E-250	98-04	CILINDRO DE RUEDA	78975	DER	25.4 mm 1"		371
	E-250	95-96	CILINDRO DE RUEDA	370042	IZQ	28.5 mm 1-1/8"		374
	E-250	95-96	CILINDRO DE RUEDA	370043	DER	28.5 mm 1-1/8"		374
	E-250	95-04	MANGUERA DE FRENOS	380385	TRAS IZQ	18"		418
	E-250	95-04	MANGUERA DE FRENOS	380387	DEL DER	16.5"		418
	E-250	95-04	MANGUERA DE FRENOS	380388	DEL IZQ	16.75"		418
	E-250	97-04	PISTÓN FRENO DE DISCO	85019	DEL	73.0 mm 2-7/8"		518
	E-250	95-96	PISTÓN FRENO DE DISCO	85155	TRAS	59.5 mm 2-11/32"	CALIPER DOBLE PISTON	520
	E-250	95-96	PISTÓN FRENO DE DISCO	850300	DEL	55.9 mm 2-13/64"	CALIPER DOBLE PISTON	529
	E-250	97-04	REPUESTO FRENO DE DISCO	1838	DEL	73.0 mm 2-7/8"		538
	E-250	95-96	REPUESTO FRENO DE DISCO	1966	TRAS	59.5 mm 2-11/32"	CALIPER DOBLE PISTON	538
	E-250	95-96	REPUESTO FRENO DE DISCO	2885	DEL	55.9 mm 2-13/64"	CALIPER DOBLE PISTON	545
	E-250 CHATEAU	99-00	CILINDRO MAESTRO	390389		1-1/4"	C/ABS EN RUEDAS TRASERAS, S/C DE VELOCIDAD V8	311
	E-250 CHATEAU	95-96	CILINDRO MAESTRO	390389		1-1/4"	S/C DE VELOCIDAD V8	311
	E-250 CHATEAU	98-98	CILINDRO MAESTRO	390389		1-1/4"	S/C DE VELOCIDAD V8	311
	E-250 CHATEAU	99-00	CILINDRO MAESTRO	390394		1-1/4"	C/ABS, 4 RUEDAS, C/C DE VELOCIDAD V8	311
	E-250 CHATEAU	95-96	CILINDRO MAESTRO	390394		1-1/4"	C/C DE VELOCIDAD V8	311
	E-250 CHATEAU	98-98	CILINDRO MAESTRO	390394		1-1/4"	C/C DE VELOCIDAD V8	311
	E-350	97-98	CILINDRO DE RUEDA	78974	IZQ	25.4 mm 1"		370
	E-350	97-98	CILINDRO DE RUEDA	78975	DER	25.4 mm 1"		371
	E-350	95-96	CILINDRO DE RUEDA	370042	IZQ	28.5 mm 1-1/8"		374
	E-350	99-04	CILINDRO DE RUEDA	370042	IZQ	28.5 mm 1-1/8"		374
	E-350	95-96	CILINDRO DE RUEDA	370043	DER	28.5 mm 1-1/8"		374
	E-350	99-04	CILINDRO DE RUEDA	370043	DER	28.5 mm 1-1/8"		374
	E-350	99-06	MANGUERA DE FRENOS	380355	DEL IZQ	24"		416
	E-350	95-98	MANGUERA DE FRENOS	380385	TRAS IZQ	18"		418
	E-350	95-06	MANGUERA DE FRENOS	380387	DEL DER	16.5"		418
	E-350	95-98	MANGUERA DE FRENOS	380388	DEL IZQ	16.75"		418
	E-350	99-04	MANGUERA DE FRENOS	381307	TRAS IZQ	17.13"		441
	E-350	97-98	PISTÓN FRENO DE DISCO	85019	DEL	73.0 mm 2-7/8"		518

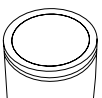



Modelo	Versión	Año	Descripción	Número Lusac	Posición	Diámetro	Notas	Foto Pág.	
CLUB WAGON	E-350	99-06	PISTÓN FRENO DE DISCO	85155	TRAS	59.5 mm 2-11/32"		520	
	E-350	95-96	PISTÓN FRENO DE DISCO	85155	TRAS	59.5 mm 2-11/32"	CALIPER DOBLE PISTON	520	
	E-350	95-96	PISTÓN FRENO DE DISCO	850300	DEL	55.9 mm 2-13/64"	CALIPER DOBLE PISTON	529	
	E-350	99-06	PISTÓN FRENO DE DISCO	850300	DEL	55.9 mm 2-13/64"	CALIPER DOBLE PISTON	529	
	E-350	97-98	REPUESTO FRENO DE DISCO	1838	DEL	73.0 mm 2-7/8"		538	
	E-350	99-06	REPUESTO FRENO DE DISCO	1966	TRAS	59.5 mm 2-11/32"		538	
	E-350	95-96	REPUESTO FRENO DE DISCO	1966	TRAS	59.5 mm 2-11/32"	CALIPER DOBLE PISTON	538	
	E-350	95-96	REPUESTO FRENO DE DISCO	2885	DEL	55.9 mm 2-13/64"	CALIPER DOBLE PISTON	545	
	E-350	99-06	REPUESTO FRENO DE DISCO	2885	DEL	55.9 mm 2-13/64"	CALIPER DOBLE PISTON	545	
	V8	95-96	CILINDRO DE RUEDA	78974	IZQ	25.4 mm 1"		370	
	V8	98-00	CILINDRO DE RUEDA	78974	IZQ	25.4 mm 1"		370	
	V8	95-96	CILINDRO DE RUEDA	78975	DER	25.4 mm 1"		371	
	V8	98-00	CILINDRO DE RUEDA	78975	DER	25.4 mm 1"		371	
	V8	98-00	MANGUERA DE FRENOS	380355	DEL IZQ	24"		416	
	V8	95-96	MANGUERA DE FRENOS	380385	TRAS IZQ	18"		418	
	V8	98-00	MANGUERA DE FRENOS	380385	TRAS IZQ	18"		418	
	V8	95-96	MANGUERA DE FRENOS	380387	DEL DER	16.5"		418	
	V8	98-00	MANGUERA DE FRENOS	380387	DEL DER	16.5"		418	
	V8	99-00	MANGUERA DE FRENOS	380387	TRAS DER	16.5"		418	
	V8	95-96	MANGUERA DE FRENOS	380388	DEL IZQ	16.75"		418	
	V8	99-00	MANGUERA DE FRENOS	380398	TRAS IZQ	21.25"		419	
	V8	99-00	PISTÓN FRENO DE DISCO	85155	TRAS	59.5 mm 2-11/32"	CALIPER DOBLE PISTON	520	
	V8	95-96	PISTÓN FRENO DE DISCO	850300	DEL	55.9 mm 2-13/64"	CALIPER DOBLE PISTON	529	
	V8	98-00	PISTÓN FRENO DE DISCO	850300	DEL	55.9 mm 2-13/64"	CALIPER DOBLE PISTON	529	
	V8	99-00	REPUESTO FRENO DE DISCO	1966	TRAS	59.5 mm 2-11/32"	CALIPER DOBLE PISTON	538	
	V8	95-96	REPUESTO FRENO DE DISCO	2885	DEL	55.9 mm 2-13/64"	CALIPER DOBLE PISTON	545	
	V8	98-00	REPUESTO FRENO DE DISCO	2885	DEL	55.9 mm 2-13/64"	CALIPER DOBLE PISTON	545	
	E-250	97-97	CILINDRO DE RUEDA	78975	DER	25.4 mm 1"		371	
	CONTOUR		96-00	MANGUERA DE FRENOS	380421	DEL DER	15.25"		420
			96-00	MANGUERA DE FRENOS	380421	DEL IZQ	15.25"		420
			96-97	MANGUERA DE FRENOS	380422	TRAS DER	12"		420
			96-97	MANGUERA DE FRENOS	380422	TRAS IZQ	12"		420
		96-97	MANGUERA DE FRENOS	380423	TRAS DER	22.25"		420	
		96-97	MANGUERA DE FRENOS	380423	TRAS IZQ	22.25"		420	
		98-00	MANGUERA DE FRENOS	380992	TRAS DER	12.28"		430	
		98-00	MANGUERA DE FRENOS	380992	TRAS IZQ	12.28"		430	
		98-00	MANGUERA DE FRENOS	380993	TRAS DER	22.68"		431	
		98-00	MANGUERA DE FRENOS	380993	TRAS IZQ	22.68"		431	
		96-00	PISTÓN FRENO DE DISCO	85800	DEL	60.0 mm		526	
		96-00	REPUESTO FRENO DE DISCO	2844	DEL	60.0 mm		544	
		96-00	CILINDRO DE RUEDA	37997	DER	7/8"		370	
		96-00	CILINDRO DE RUEDA	37997	IZQ	7/8"		370	





Modelo	Versión	Año	Descripción	Número Lusac	Posición	Diámetro	Notas	Foto Pág.	
FORD									
CONTOUR		96-00	CILINDRO DE RUEDA	370080	DER	13/16"		375	
		96-00	CILINDRO DE RUEDA	370080	IZQ	13/16"		375	
		96-96	CILINDRO MAESTRO	390226		1"	S/ABS	304	
		97-00	CILINDRO MAESTRO	390463		1"	S/ABS	315	
		96-00	CILINDRO MAESTRO	390553		1"	C/ABS, C/C DE TRACCIÓN	318	
		96-00	CILINDRO MAESTRO	F7RZ2140		25.4 mm 1"		363	
COUGAR		87-88	MANGUERA DE FRENOS	38384	DEL DER	16.5"			
		90-92	MANGUERA DE FRENOS	38609	TRAS DER	19.75"		393	
		90-92	MANGUERA DE FRENOS	38610	TRAS IZQ	19.75"		393	
		90-92	MANGUERA DE FRENOS	38668	DEL DER	20"		396	
		90-92	MANGUERA DE FRENOS	38997	DEL IZQ	14"		403	
		93-95	MANGUERA DE FRENOS	380193	TRAS DER	20"		408	
		93-95	MANGUERA DE FRENOS	380194	TRAS IZQ	25.25"		408	
		93-95	MANGUERA DE FRENOS	380214	TRAS DER	20"		408	
		93-95	MANGUERA DE FRENOS	380215	TRAS IZQ	17.88"		408	
		93-95	MANGUERA DE FRENOS	380373	DEL DER	16"		417	
		93-95	MANGUERA DE FRENOS	380374	DEL IZQ	16"		417	
		85-88	MANGUERA DE FRENOS	5022M	TRAS IZQ	13"	DEL 87-88 TAMBIÉN PUEDE LLEVAR LA MANGUERA 38506 TRAS/IZQ	516	
		90-92	PISTÓN FRENO DE DISCO	85171	DEL	65.9 mm 2-19/32"		521	
		85-88	PISTÓN FRENO DE DISCO	99080	DEL	60.0 mm		528	
		93-95	PISTÓN FRENO DE DISCO	99080	DEL	60.0 mm		528	
		90-95	REPUESTO FRENO DE DISCO	1967	TRAS	45.0 mm		538	
		85-88	REPUESTO FRENO DE DISCO	99079	DEL	60.0 mm		553	
		93-95	REPUESTO FRENO DE DISCO	99079	DEL	60.0 mm		553	
		90-92	REPUESTO FRENO DE DISCO	04-112486	DEL	65.9 mm 2-19/32"		554	
		XR-7	90-94	CILINDRO MAESTRO	122572		25.4 mm 1"		299
		XR-7	90-94	MANGUERA DE FRENOS	380193	TRAS DER	20"		408
		XR-7	90-94	MANGUERA DE FRENOS	380194	TRAS IZQ	25.25"		408
		XR-7	90-94	MANGUERA DE FRENOS	380373	DEL DER	16"		417
		XR-7	90-94	MANGUERA DE FRENOS	380374	DEL IZQ	16"		417
		XR-7	90-94	PISTÓN FRENO DE DISCO	99080	DEL	60.0 mm		528
		XR-7	90-94	REP. CIL. MAESTRO Y DE CLUTCH	120797		25.4 mm 1"		562
		XR-7	90-94	REPUESTO FRENO DE DISCO	1967	TRAS	45.0 mm		538
		XR-7	90-94	REPUESTO FRENO DE DISCO	99079	DEL	60.0 mm		553
			85-88	CILINDRO DE RUEDA	101604	DER	19.0 mm 3/4"		372
			90-92	CILINDRO DE RUEDA	101604	DER	19.0 mm 3/4"		372
			85-88	CILINDRO DE RUEDA	101604	IZQ	19.0 mm 3/4"		372
			90-92	CILINDRO DE RUEDA	101604	IZQ	19.0 mm 3/4"		372
			93-95	CILINDRO DE RUEDA	129564	DER	25.4 mm 1"		374
		93-95	CILINDRO DE RUEDA	129564	IZQ	25.4 mm 1"		374	
		85-86	CILINDRO MAESTRO	112311		21.0 mm 53/64"			
		87-88	CILINDRO MAESTRO	117583		21.0 & 30.2 mm			
		90-95	CILINDRO MAESTRO	122572		25.4 mm 1"	S/ABS	299	

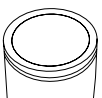



Modelo	Versión	Año	Descripción	Número Lusac	Posición	Diámetro	Notas	Foto Pág.
COUGAR		93-95	CILINDRO MAESTRO	390126		1-1/16"	C/ABS	301
		90-95	REP. CIL. MAESTRO Y DE CLUTCH	120797		25.4 mm 1"		562
		95-96	REPUESTO CILINDRO DE RUEDA	04-112366		25.4 mm 1"		
COURIER	PICK UP	01-10	CILINDRO DE RUEDA	3700904	IZQ	22.2 mm 7/8"		383
	PICK UP	01-10	CILINDRO MAESTRO	39009904		15/16"		360
	PICK UP	01-10	PISTÓN FRENO DE DISCO	85812	DEL	54.0 mm 2-1/8"		526
	PICK UP	01-10	REP. CIL. MAESTRO Y DE CLUTCH	903320		23.8 mm 15/16"		562
	PICK UP	01-10	REPUESTO FRENO DE DISCO	1449	DEL	54.0 mm 2-1/8"		537
		01-10	KIT DE PISTÓN Y REPUESTO FD	742387	DEL	54.0 mm 2-1/8"	PARA AUTOS QUE LLEVAN LA BALATA 7259-D649	
E-150		10-10	CILINDRO MAESTRO	391193		33.3 mm 1-5/16"		348
		10-10	CILINDRO MAESTRO	391194		33.3 mm 1-5/16"		
		95-03	KIT DE PISTÓN Y REPUESTO FD	742352	DEL	73.0 mm 2-7/8"	6 V	
		95-07	KIT DE PISTÓN Y REPUESTO FD	742352	DEL	73.0 mm 2-7/8"		
		92-93	MANGUERA DE FRENOS	380075	DEL DER	24"	CHOCOLATE	406
		92-93	MANGUERA DE FRENOS	380076	DEL IZQ	22.5"	CHOCOLATE	406
		04-06	MANGUERA DE FRENOS	382694	DEL IZQ	30.12"		483
		04-06	MANGUERA DE FRENOS	382695	DEL DER	30.12"		483
		04-04	MANGUERA DE FRENOS	382697	TRAS DER	14.12"		483
		04-05	MANGUERA DE FRENOS	382697	TRAS DER	14.12"		483
		05-06	MANGUERA DE FRENOS	382697	TRAS DER	14.12"		483
		06-07	MANGUERA DE FRENOS	382697	TRAS DER	14.12"		483
		07-07	MANGUERA DE FRENOS	382697	TRAS DER	14.12"		483
E-250		92-93	CILINDRO DE CLUTCH	360046	INF	25.4 mm 1"		
		95-99	KIT DE PISTÓN Y REPUESTO FD	742338	DEL	55.9 mm 2-13/64"	8 V	
		97-04	KIT DE PISTÓN Y REPUESTO FD	742352	DEL	73.0 mm 2-7/8"	8 V	
		95-96	KIT DE PISTÓN Y REPUESTO FD	742353	TRAS	59.5 mm 2-11/32"	8 V	
		99-00	KIT DE PISTÓN Y REPUESTO FD	742353	TRAS	59.5 mm 2-11/32"	8 V	
	CHATEAU	95-96	CILINDRO DE RUEDA	78974	IZQ	25.4 mm 1"		370
	CHATEAU	98-00	CILINDRO DE RUEDA	78974	IZQ	25.4 mm 1"		370
	CHATEAU	95-96	CILINDRO DE RUEDA	78975	DER	25.4 mm 1"		371
	CHATEAU	98-00	CILINDRO DE RUEDA	78975	DER	25.4 mm 1"		371
	CHATEAU	98-00	MANGUERA DE FRENOS	380355	DEL IZQ	24"		416
	CHATEAU	95-96	MANGUERA DE FRENOS	380385	TRAS IZQ	18"		418
E-250	CHATEAU	98-00	MANGUERA DE FRENOS	380385	TRAS IZQ	18"		418
	CHATEAU	95-96	MANGUERA DE FRENOS	380387	DEL DER	16.5"		418
	CHATEAU	98-00	MANGUERA DE FRENOS	380387	DEL DER	16.5"		418
	CHATEAU	99-00	MANGUERA DE FRENOS	380387	TRAS DER	16.5"		418
	CHATEAU	95-96	MANGUERA DE FRENOS	380388	DEL IZQ	16.75"		418
	CHATEAU	99-00	MANGUERA DE FRENOS	380398	TRAS IZQ	21.25"		419
	CHATEAU	99-00	PISTÓN FRENO DE DISCO	85155	TRAS	59.5 mm 2-11/32"	CALIPER DOBLE PISTON	520
	CHATEAU	95-96	PISTÓN FRENO DE DISCO	850300	DEL	55.9 mm 2-13/64"	CALIPER DOBLE PISTON	529
	CHATEAU	98-00	PISTÓN FRENO DE DISCO	850300	DEL	55.9 mm 2-13/64"	CALIPER DOBLE PISTON	529





Modelo	Versión	Año	Descripción	Número Lusac	Posición	Diámetro	Notas	Foto Pág.
FORD								
E-250	CHATEAU	99-00	REPUESTO FRENO DE DISCO	1966	TRAS	59.5 mm 2-11/32"	CALIPER DOBLE PISTON	538
	CHATEAU	95-96	REPUESTO FRENO DE DISCO	2885	DEL	55.9 mm 2-13/64"	CALIPER DOBLE PISTON	545
	CHATEAU	98-00	REPUESTO FRENO DE DISCO	2885	DEL	55.9 mm 2-13/64"	CALIPER DOBLE PISTON	545
E350		09-14	CILINDRO MAESTRO	391193		33.3 mm 1-5/16"	5.4 4X2 C/C DE ESTABILIDAD C/C ACTIVO DE FRENOS	348
		10-10	CILINDRO MAESTRO	391194		33.3 mm 1-5/16"	6.8 4X2 S/C DE ESTABILIDAD	
		09-11	CILINDRO MAESTRO	391194		33.3 mm 1-5/16"		
		08-08	CILINDRO MAESTRO	391236		33.3 mm 1-5/16"	CON RODADA SENCILLA	351
		08-08	CILINDRO MAESTRO	391257		33.3 mm 1-5/16"	C/C DE ESTABILIDAD	352
		95-96	KIT DE PISTÓN Y REPUESTO FD	742338	DEL	55.9 mm 2-13/64"	8 V	
		99-06	KIT DE PISTÓN Y REPUESTO FD	742338	DEL	55.9 mm 2-13/64"	8 V	
		06-07	KIT DE PISTÓN Y REPUESTO FD	742338	DEL	55.9 mm 2-13/64"	DIESEL	
		98-99	KIT DE PISTÓN Y REPUESTO FD	742338	DEL	55.9 mm 2-13/64"		
		06-07	KIT DE PISTÓN Y REPUESTO FD	742338	DEL	55.9 mm 2-13/64"		
		97-98	KIT DE PISTÓN Y REPUESTO FD	742352	DEL	73.0 mm 2-7/8"	8 V	
		01-01	KIT DE PISTÓN Y REPUESTO FD	742352	DEL	73.0 mm 2-7/8"	DIESEL	
		03-03	KIT DE PISTÓN Y REPUESTO FD	742352	DEL	73.0 mm 2-7/8"	DIESEL	
		95-96	KIT DE PISTÓN Y REPUESTO FD	742353	TRAS	59.5 mm 2-11/32"	8 V	
		99-06	KIT DE PISTÓN Y REPUESTO FD	742353	TRAS	59.5 mm 2-11/32"	8 V	
	06-07	KIT DE PISTÓN Y REPUESTO FD	742353	TRAS	59.5 mm 2-11/32"	DIESEL		
ECO SPORT		04-10	PISTÓN FRENO DE DISCO	85812	DEL	54.0 mm 2-1/8"		526
		04-10	REPUESTO FRENO DE DISCO	1449	DEL	54.0 mm 2-1/8"		537
		04-10	CILINDRO DE RUEDA	3700908	DER	19.0 mm 3/4"		383
		04-10	CILINDRO DE RUEDA	3700908	IZQ	19.0 mm 3/4"		383
		04-10	CILINDRO MAESTRO	39009906		15/16"		360
		04-10	KIT DE PISTÓN Y REPUESTO FD	742387	DEL	54.0 mm 2-1/8"		
		04-10	REP. CIL. MAESTRO Y DE CLUTCH	904081		23.8 mm 15/16"		562
ECONOLINE		99-07	MANGUERA DE FRENOS	380324	DEL DER	22.75"		413
		97-99	MANGUERA DE FRENOS	380355	DEL IZQ	24"		416
		99-07	MANGUERA DE FRENOS	380356	DEL IZQ	21.5"		416
		97-07	MANGUERA DE FRENOS	380385	TRAS IZQ	18"		418
		97-99	MANGUERA DE FRENOS	380387	DEL DER	16.5"		418
		98-99	MANGUERA DE FRENOS	380388	DEL IZQ	16.75"		418
		08-14	MANGUERA DE FRENOS	382708	TRAS DER	12"		484
		99-07	PISTÓN FRENO DE DISCO	85019	DEL	73.0 mm 2-7/8"		518
		97-99	PISTÓN FRENO DE DISCO	850300	DEL	55.9 mm 2-13/64"	CALIPER DOBLE PISTON	529
	99-07	REPUESTO FRENO DE DISCO	1838	DEL	73.0 mm 2-7/8"		538	

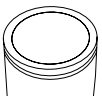



Modelo	Versión	Año	Descripción	Número Lusac	Posición	Diámetro	Notas	Foto Pág.
ECONOLINE		97-99	REPUESTO FRENO DE DISCO	2885	DEL	55.9 mm 2-13/64"	CALIPER DOBLE PISTON	545
	CLUB WAGON E150	94-94	MANGUERA DE FRENOS	380324	DER	22.75"		413
	CLUB WAGON E150	92-94	MANGUERA DE FRENOS	380385	CTR	18"		418
	CLUB WAGON E-150	95-96	CILINDRO MAESTRO	120369		26.9 mm 1-1/16"	S/C DE VELOCIDAD	298
	CLUB WAGON E-150	95-96	CILINDRO MAESTRO	390183		1-1/8"	C/C DE VELOCIDAD, 4X4	302
	CLUB WAGON E-150	97-01	CILINDRO MAESTRO	390392		1-1/8"	S/C DE VELOCIDAD	311
	CLUB WAGON E-150	97-01	CILINDRO MAESTRO	390393		1-1/8"	C/C DE VELOCIDAD, 4X4	311
	CLUB WAGON E-150	04-06	CILINDRO MAESTRO	390526		1-5/16"		316
	CLUB WAGON E-150	02-03	CILINDRO MAESTRO	390741		1-1/8"	C/C DE VELOCIDAD	325
	CLUB WAGON E-150	02-03	CILINDRO MAESTRO	390787		1-1/8"	S/C DE VELOCIDAD	328
	CLUB WAGON E-150	95-96	REPUESTO CILINDRO DE RUEDA	114084		26.9 mm 1-1/16"		561
	CLUB WAGON E-250	95-96	CILINDRO MAESTRO	390182		1-1/8"	C/ABS EN RUEDAS TRASERAS, S/C DE VELOCIDAD	302
	CLUB WAGON E-250	95-00	CILINDRO MAESTRO	390389		1-1/4"		311
	CLUB WAGON E-250	95-96	CILINDRO MAESTRO	390394		1-1/4"	C/C DE VELOCIDAD	311
	CLUB WAGON E-250	01-04	CILINDRO MAESTRO	390526		1-5/16"	S/C DE VELOCIDAD	316
	CLUB WAGON E-250	97-04	CILINDRO MAESTRO	390536		1-5/16"	C/C DE VELOCIDAD	317
	CLUB WAGON E-250	95-96	REP. CIL. MAESTRO Y DE CLUTCH	114085		28.5 mm 1-1/8"		561
	CLUB WAGON E350	93-94	CILINDRO DE RUEDA	37250	IZQ	30.1 mm 1-3/16"	DOBLE RODADA	364
	CLUB WAGON E350	93-94	CILINDRO DE RUEDA	37251	DER	30.1 mm 1-3/16"	DOBLE RODADA	365
	CLUB WAGON E350	92-94	MANGUERA DE FRENOS	380385	CTR	18"		418
	CLUB WAGON E-350	95-96	CILINDRO MAESTRO	390182		1-1/8"	C/ABS EN RUEDAS TRASERAS, S/C DE VELOCIDAD	302
	CLUB WAGON E-350	95-00	CILINDRO MAESTRO	390394		1-1/4"	C/C DE VELOCIDAD	311
	CLUB WAGON E-350	01-06	CILINDRO MAESTRO	390526		1-5/16"	S/C DE VELOCIDAD	316
	CLUB WAGON E-350	97-98	CILINDRO MAESTRO	390536		1-5/16"		317
	CLUB WAGON E-350	01-04	CILINDRO MAESTRO	390536		1-5/16"	C/C DE VELOCIDAD	317
	CLUB WAGON E-350	95-96	REP. CIL. MAESTRO Y DE CLUTCH	114085		28.5 mm 1-1/8"		561
	E-150	94-94	MANGUERA DE FRENOS	380324	DER	22.75"		413
	E-150	92-94	MANGUERA DE FRENOS	380385	CTR	18"		418
	E-150	95-96	CILINDRO DE RUEDA	59240	IZQ	23.8 mm 15/16"		370
	E-150	95-96	CILINDRO DE RUEDA	59241	DER	23.8 mm 15/16"		370
	E-150	97-98	CILINDRO DE RUEDA	78974	IZQ	25.4 mm 1"		370
	E-150	97-98	CILINDRO DE RUEDA	78975	DER	25.4 mm 1"		371
	E-150	95-96	CILINDRO MAESTRO	120369		26.9 mm 1-1/16"	S/C DE VELOCIDAD	298
	E-150	97-98	CILINDRO MAESTRO	390392		1-1/8"	S/C DE VELOCIDAD	311
	E-150	97-98	CILINDRO MAESTRO	390393		1-1/8"	C/C DE VELOCIDAD	311





Modelo	Versión	Año	Descripción	Número Lusac	Posición	Diámetro	Notas	Foto Pág.
FORD								
ECONOLINET	E-150	95-98	MANGUERA DE FRENOS	380324	DEL DER	22.75"		413
	E-150	95-98	MANGUERA DE FRENOS	380356	DEL IZQ	21.5"		416
	E-150	95-98	MANGUERA DE FRENOS	380385	TRAS IZQ	18"		418
	E-150	95-98	PISTÓN FRENO DE DISCO	85019	DEL	73.0 mm 2-7/8"		518
	E-150	95-96	REPUESTO CILINDRO DE RUEDA	114084		26.9 mm 1-1/16"		561
	E-150	95-98	REPUESTO FRENO DE DISCO	1838	DEL	73.0 mm 2-7/8"		538
	E-150 VAN, E-150 WAGON	99-07	CILINDRO DE RUEDA	78974	IZQ	25.4 mm 1"		370
	E-150 VAN, E-150 WAGON	99-07	CILINDRO DE RUEDA	78975	DER	25.4 mm 1"		371
	E-150 VAN, E-150 WAGON	97-97	CILINDRO DE RUEDA	370042	IZQ	28.5 mm 1-1/8"		374
	E-150 VAN, E-150 WAGON	97-97	CILINDRO MAESTRO	390182		1-1/8"		302
	E-150 VAN, E-150 WAGON	01-01	CILINDRO MAESTRO	390392		1-1/8"	S/C DE VELOCIDAD	311
	E-150 VAN, E-150 WAGON	99-01	CILINDRO MAESTRO	390393		1-1/8"	C/C DE VELOCIDAD	311
	E-150 VAN, E-150 WAGON	99-00	CILINDRO MAESTRO	390394		1-1/4"	S/C DE VELOCIDAD	311
	E-150 VAN, E-150 WAGON	05-07	CILINDRO MAESTRO	390526		1-5/16"		316
	E-150 VAN, E-150 WAGON	02-03	CILINDRO MAESTRO	390741		1-1/8"	C/C DE VELOCIDAD	325
	E-150 VAN, E-150 WAGON	02-03	CILINDRO MAESTRO	390787		1-1/8"	S/C DE VELOCIDAD	328
	E-150 VAN, E-150 WAGON	04-04	CILINDRO MAESTRO	390847		1-1/4"	S/C DE VELOCIDAD	331
	E-150 VAN, E-150 WAGON	08-14	CILINDRO MAESTRO	391192		1-5/16"		348
	E-150 VAN, E-150 WAGON	97-97	REP. CIL. MAESTRO Y DE CLUTCH	114085		28.5 mm 1-1/8"		561
	E250	85-94	CILINDRO DE RUEDA	78974	IZQ	25.4 mm 1"		370
	E250	85-94	CILINDRO DE RUEDA	78975	DER	25.4 mm 1"		371
	E250	03-04	CILINDRO MAESTRO	390848		1 5/16"		331
	E250	07-07	CILINDRO MAESTRO	390848		1 5/16"		331
	E250	92-94	MANGUERA DE FRENOS	380385	CTR	18"		418
	E250 Ext.	03-04	CILINDRO MAESTRO	390848		1 5/16"		331
	E250 Super Duty	03-04	CILINDRO MAESTRO	390848		1 5/16"		331
	E250 Super Duty	07-07	CILINDRO MAESTRO	390848		1 5/16"		331
	E250 Super Duty Ext.	07-07	CILINDRO MAESTRO	390848		1 5/16"		331
	E-250 VAN, E-250 WAGON	98-99	CILINDRO DE RUEDA	370042	IZQ	28.5 mm 1-1/8"		374

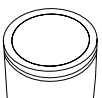

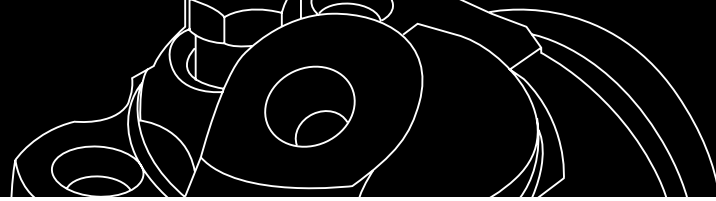

Modelo	Versión	Año	Descripción	Número Lusac	Posición	Diámetro	Notas	Foto Pág.
ECONOLINE	E-250 VAN, E-250 WAGON	97-99	CILINDRO DE RUEDA	370043	DER	28.5 mm 1-1/8"		374
	E-250 VAN, E-250 WAGON	98-99	CILINDRO MAESTRO	390389		1-1/4"	C/ABS	311
	E-250 VAN, E-250 WAGON	98-99	CILINDRO MAESTRO	390394		1-1/4"	C/C DE VELOCIDAD	311
	E350	93-94	CILINDRO DE RUEDA	37250	IZQ	30.1 mm 1-3/16"	DOBLE RODADA	364
	E350	93-94	CILINDRO DE RUEDA	37251	DER	30.1 mm 1-3/16"	DOBLE RODADA	365
	E350	92-94	MANGUERA DE FRENOS	380385	CTR	18"		418
	E-350	98-98	CILINDRO DE RUEDA	37250	IZQ	30.1 mm 1-3/16"		364
	E-350	98-98	CILINDRO DE RUEDA	37251	DER	30.1 mm 1-3/16"		365
	E-350	99-99	CILINDRO DE RUEDA	370042	IZQ	28.5 mm 1-1/8"		374
	E-350	99-99	CILINDRO DE RUEDA	370043	DER	28.5 mm 1-1/8"		374
	E-350	98-99	CILINDRO MAESTRO	390389		1-1/4"	S/C DE VELOCIDAD	311
	E-350	98-98	CILINDRO MAESTRO	390394		1-1/4"	C/C DE VELOCIDAD	311
	E-350	99-99	CILINDRO MAESTRO	390526		1-5/16"	S/C DE VELOCIDAD	316
	E-350	06-07	CILINDRO MAESTRO	390526		1-5/16"	S/C DE VELOCIDAD	316
	E-350	99-99	CILINDRO MAESTRO	390536		1-5/16"	C/C DE VELOCIDAD	317
	E-350	08-14	CILINDRO MAESTRO	391191		1-5/16"	C/C DE ESTABILIDAD 6.8 LTS	
	E-350	08-14	CILINDRO MAESTRO	391192		1-5/16"	C/C DE ESTABILIDAD 5.4 LTS	348
	E-350	98-99	MANGUERA DE FRENOS	380355	DEL IZQ	24"		416
	E-350	06-07	MANGUERA DE FRENOS	380355	DEL IZQ	24"		416
	E-350	98-99	MANGUERA DE FRENOS	380385	TRAS DER	18"		418
	E-350	06-07	MANGUERA DE FRENOS	380385	TRAS DER	18"		418
	E-350	06-07	MANGUERA DE FRENOS	380385	TRAS IZQ	18"		418
	E-350	98-99	MANGUERA DE FRENOS	380385	TRAS IZQ	18"		418
	E-350	98-99	MANGUERA DE FRENOS	380387	DEL DER	16.5"		418
	E-350	06-07	MANGUERA DE FRENOS	380387	DEL DER	16.5"		418
	E-350	08-14	MANGUERA DE FRENOS	381307	TRAS IZQ	17.13"		441
	E-350	08-14	MANGUERA DE FRENOS	382707	TRAS IZQ	36.62"		484
	E-350	08-14	MANGUERA DE FRENOS	382708	TRAS DER	12"		484
	E-350	99-99	PISTÓN FRENO DE DISCO	85155	TRAS	59.5 mm 2-11/32"		520
	E-350	06-07	PISTÓN FRENO DE DISCO	85155	TRAS	59.5 mm 2-11/32"		520
	E-350	98-99	PISTÓN FRENO DE DISCO	850300	DEL	55.9 mm 2-13/64"	CALIPER DOBLE PISTON	529
	E-350	06-07	PISTÓN FRENO DE DISCO	850300	DEL	55.9 mm 2-13/64"	CALIPER DOBLE PISTON	529
	E-350	99-99	REPUESTO FRENO DE DISCO	1966	TRAS	59.5 mm 2-11/32"		538
	E-350	06-07	REPUESTO FRENO DE DISCO	1966	TRAS	59.5 mm 2-11/32"		538
	E-350	98-99	REPUESTO FRENO DE DISCO	2885	DEL	55.9 mm 2-13/64"	CALIPER DOBLE PISTON	545
	E-350	06-07	REPUESTO FRENO DE DISCO	2885	DEL	55.9 mm 2-13/64"	CALIPER DOBLE PISTON	545
	E350 Super Duty	05-07	CILINDRO MAESTRO	390848		1 5/16"		331
	E350 Super Duty Ext.	05-07	CILINDRO MAESTRO	390848		1 5/16"		331
	WAGON DIESEL	01-01	CILINDRO DE RUEDA	78974	IZQ	25.4 mm 1"		370





Modelo	Versión	Año	Descripción	Número Lusac	Posición	Diámetro	Notas	Foto Pág.
FORD								
ECONOLINE	WAGON DIESEL	03-03	CILINDRO DE RUEDA	78974	IZQ	25.4 mm 1"		370
	WAGON DIESEL	03-03	CILINDRO DE RUEDA	78975	DER	25.4 mm 1"		371
	WAGON DIESEL	01-01	CILINDRO MAESTRO	390526		1-5/16"	S/C DE VELOCIDAD	316
	WAGON DIESEL	03-03	CILINDRO MAESTRO	390526		1-5/16"	S/C DE VELOCIDAD	316
	WAGON DIESEL	01-01	MANGUERA DE FRENOS	380355	DEL IZQ	24"		416
	WAGON DIESEL	03-03	MANGUERA DE FRENOS	380355	DEL IZQ	24"		416
	WAGON DIESEL	01-01	MANGUERA DE FRENOS	380385	TRAS IZQ	18"		418
	WAGON DIESEL	03-03	MANGUERA DE FRENOS	380385	TRAS IZQ	18"		418
	WAGON DIESEL	01-01	MANGUERA DE FRENOS	380387	DEL DER	16.5"		418
	WAGON DIESEL	03-03	MANGUERA DE FRENOS	380387	DEL DER	16.5"		418
	WAGON DIESEL	01-01	PISTÓN FRENO DE DISCO	85019	DEL	73.0 mm 2-7/8"		518
	WAGON DIESEL	03-03	PISTÓN FRENO DE DISCO	85019	DEL	73.0 mm 2-7/8"		518
	WAGON DIESEL	01-01	REPUESTO FRENO DE DISCO	1838	DEL	73.0 mm 2-7/8"		538
	WAGON DIESEL	03-03	REPUESTO FRENO DE DISCO	1838	DEL	73.0 mm 2-7/8"		538
	Wagon E350 Super Duty	05-07	CILINDRO MAESTRO	390848		1 5/16"		331
ESCAPE		05-08	MANGUERA DE FRENOS	382387	TRAS DER	18.13"		462
		05-08	MANGUERA DE FRENOS	382388	TRAS IZQ	18.25"		462
		01-08	MANGUERA DE FRENOS	382460	TRAS IZQ	11 9/16"		466
		01-08	MANGUERA DE FRENOS	382462	DEL DER	17.38"		466
		01-08	MANGUERA DE FRENOS	382462	DEL IZQ	17.38"		466
		07-12	MANGUERA DE FRENOS	382544	TRAS DER	10.62"		471
		07-12	MANGUERA DE FRENOS	382545	TRAS IZQ	11.56"	DS TAMBIÉN PUEDE LLEVAR LA MANGUERA TASERA IZQ 382582 DEL 07 AL 08	471
		01-10	PISTÓN FRENO DE DISCO	85800	DEL	60.0 mm		526
		01-10	REPUESTO FRENO DE DISCO	2844	DEL	60.0 mm		544
		01-08	CILINDRO DE RUEDA	370094	DER	15/16"		376
		01-08	CILINDRO DE RUEDA	370094	IZQ	15/16"		376
		09-12	CILINDRO DE RUEDA	370211	DER	15/16"		381
		09-12	CILINDRO DE RUEDA	370211	IZQ	15/16"		381
		05-06	CILINDRO MAESTRO	390526		1-5/16"		316
		01-04	CILINDRO MAESTRO	390690		1"	4X2, AUTOMÁTICO	322
		01-04	CILINDRO MAESTRO	390691		1"	ESTÁNDAR 4X4	322
		05-08	CILINDRO MAESTRO	390909		1-1/16"	LIMITED Y XLT	334
		05-08	CILINDRO MAESTRO	390910		1"	DISCO-TAMBOR AUTOMÁTICO	334
		07-08	CILINDRO MAESTRO	391202		26.9 mm 1-1/16"		
		09-12	CILINDRO MAESTRO	391203		1-1/16"	AUTOMÁTICO	349
	09-12	CILINDRO MAESTRO	391204		26.9 mm 1-1/16"	MANUAL		
	13-14	CILINDRO MAESTRO	391387		25.4 mm 1"			
	01-06	MANGUERA DE FRENOS	380451	TRAS IZQ	11.75"		420	
	07-08	MANGUERA DE FRENOS	382582	TRAS IZQ	18.25"		474	

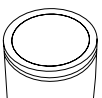



Modelo	Versión	Año	Descripción	Número Lusac	Posición	Diámetro	Notas	Foto Pág.		
ESCORT		94-99	MANGUERA DE FRENOS	38840	TRAS DER	11"		398		
		94-99	MANGUERA DE FRENOS	38840	TRAS IZQ	11"		398		
		94-99	MANGUERA DE FRENOS	38842	TRAS DER	16.13"		398		
		94-99	MANGUERA DE FRENOS	38842	TRAS IZQ	16.13"		398		
		94-99	MANGUERA DE FRENOS	380463	DEL DER	16.25"		421		
		94-99	MANGUERA DE FRENOS	380463	DEL IZQ	16.25"		421		
		94-99	PISTÓN FRENO DE DISCO	85384	DEL	54.0 mm 2-1/8"		523		
		94-99	REPUESTO FRENO DE DISCO	2735	TRAS	30.1 mm 1-3/16"		543		
		94-99	REPUESTO FRENO DE DISCO	2776	DEL	54.0 mm 2-1/8"		543		
	GT	94-95	CILINDRO MAESTRO	390224			15/16"	AUTOMÁTICO	304	
	GT	94-95	CILINDRO MAESTRO	390225			15/16"	ESTÁNDAR	304	
	GT	94-95	MANGUERA DE FRENOS	38842	TRAS DER	16.13"			398	
	GT	94-95	MANGUERA DE FRENOS	38842	TRAS IZQ	16.13"			398	
	GT	94-95	MANGUERA DE FRENOS	380463	DEL DER	16.25"			421	
	GT	94-95	MANGUERA DE FRENOS	380463	DEL IZQ	16.25"			421	
	GT	94-95	PISTÓN FRENO DE DISCO	85384	DEL	54.0 mm 2-1/8"			523	
	GT	94-95	REPUESTO FRENO DE DISCO	2735	TRAS	30.1 mm 1-3/16"			543	
	GT	94-95	REPUESTO FRENO DE DISCO	2776	DEL	54.0 mm 2-1/8"			543	
	VAGONETA	94-99	CILINDRO DE RUEDA	37787	DER	11/16"			366	
	VAGONETA	94-99	CILINDRO DE RUEDA	37787	IZQ	11/16"			366	
	VAGONETA	94-96	CILINDRO MAESTRO	390224			15/16"	AUTOMÁTICO	304	
	VAGONETA	94-96	CILINDRO MAESTRO	390225			15/16"	ESTÁNDAR	304	
	VAGONETA	97-99	CILINDRO MAESTRO	390447			15/16"	DISCO-DISCO S/ ABS AUTOMÁTICO	314	
	VAGONETA	97-99	CILINDRO MAESTRO	390448			15/16"	C/ABS AUTOMÁTICO	314	
	VAGONETA	97-99	CILINDRO MAESTRO	390515			15/16"	DISCO-TAMBOR S/ ABS AUTOMÁTICO	316	
	VAGONETA	94-99	MANGUERA DE FRENOS	38840	TRAS DER	11"			398	
	VAGONETA	94-99	MANGUERA DE FRENOS	38840	TRAS IZQ	11"			398	
	VAGONETA	97-99	MANGUERA DE FRENOS	38842	TRAS DER	16.13"			398	
	VAGONETA	97-99	MANGUERA DE FRENOS	38842	TRAS IZQ	16.13"			398	
	VAGONETA	94-99	MANGUERA DE FRENOS	380463	DEL DER	16.25"			421	
	VAGONETA	94-99	MANGUERA DE FRENOS	380463	DEL IZQ	16.25"			421	
	VAGONETA	94-99	PISTÓN FRENO DE DISCO	85384	DEL	54.0 mm 2-1/8"			523	
	VAGONETA	97-99	REPUESTO FRENO DE DISCO	2735	TRAS	30.1 mm 1-3/16"			543	
	VAGONETA	94-99	REPUESTO FRENO DE DISCO	2776	DEL	54.0 mm 2-1/8"			543	
			91-96	CILINDRO DE CLUTCH	37900			19.0 mm 3/4"	SALIDA TRASE-RA NACIONAL	
			91-96	CILINDRO DE CLUTCH	39820			15.8 mm 5/8"		
			91-03	CILINDRO DE RUEDA	37787	TRAS DER	11/16"			366
			00-03	CILINDRO DE RUEDA	37787	TRAS IZQ	11/16"			366
			94-96	CILINDRO MAESTRO	390224			15/16"	AUTOMÁTICO	304
			94-96	CILINDRO MAESTRO	390225			15/16"	ESTÁNDAR	304
		97-03	CILINDRO MAESTRO	390447			15/16"	DISCO-DISCO S/ ABS TRANSEJE AUTOMÁTICO	314	
		97-03	CILINDRO MAESTRO	390448			15/16"	TRANSEJE AUTO-MÁTICO; C/ABS	314	
		97-03	CILINDRO MAESTRO	390449			15/16"	DISCO-DISCO S/ABS TRANSEJE MANUAL	314	





Modelo	Versión	Año	Descripción	Número Lusac	Posición	Diámetro	Notas	Foto Pág.
FORD								
ESCORT		97-03	CILINDRO MAESTRO	390450		15/16"	TRANSEJE MA- NUAL; C/ABS	314
		97-03	CILINDRO MAESTRO	390514		15/16"	DISCO-TAMBOR S/ABS TRANSE- JE MANUAL	316
		97-03	CILINDRO MAESTRO	390515		15/16"	DISCO-TAMBOR S/ABS TRANSEJE AUTOMÁTICO	316
		91-93	MANGUERA DE FRENOS	38840	TRAS DER	11"	DISCO-TAMBOR S/ABS TRANSEJE AUTOMÁTICO	398
		00-03	MANGUERA DE FRENOS	38840	TRAS DER	11"	DISCO-TAMBOR S/ABS TRANSEJE AUTOMÁTICO	398
		00-03	MANGUERA DE FRENOS	38842	TRAS IZQ DER	16.13"		398
		91-93	MANGUERA DE FRENOS	38842	TRAS IZQ DER	16.13"	DISCO-DISCO S/ABS TRANSEJE MANUAL	398
		00-03	MANGUERA DE FRENOS	38842	TRAS IZQ DER	16.13"	DISCO-DISCO S/ABS TRANSEJE MANUAL	398
EXCURSION		01-05	MANGUERA DE FRENOS	381163	TRAS DER	16.89"		436
		01-05	MANGUERA DE FRENOS	381163	TRAS IZQ	16.89"		436
		01-05	MANGUERA DE FRENOS	381164	TRAS DER	20.83"		436
		01-05	MANGUERA DE FRENOS	381164	TRAS IZQ	20.83"		436
		01-05	MANGUERA DE FRENOS	381169	DEL DER	20.81"		437
		01-05	MANGUERA DE FRENOS	381170	DEL IZQ	20.81"		437
		01-05	MANGUERA DE FRENOS	381187	DEL DER	19.98"		437
		01-05	MANGUERA DE FRENOS	381188	DEL IZQ	19.98"		437
		01-05	PISTÓN FRENO DE DISCO	85815	DEL	54.0 mm 2-1/8"	CALIPER DOBLE PISTON	526
		01-05	PISTÓN FRENO DE DISCO	850810	TRAS	44.4 mm 1-3/4"	CALIPER DOBLE PISTON	530
		01-05	REPUESTO FRENO DE DISCO	2081	TRAS	44.4 mm 1-3/4"	CALIPER DOBLE PISTON	
		01-05	REPUESTO FRENO DE DISCO	2815	DEL	54.0 mm 2-1/8"	CALIPER DOBLE PISTON	544
		00-05	CILINDRO MAESTRO	390530		1-3/8"	4X2, 4X4	317
		00-04	CILINDRO MAESTRO	390590		2"	S/C DE VELO- CIDAD 4X2	320
		01-05	KIT DE PISTÓN Y REPUESTO FD	742330	DEL TRAS	54.0 mm 2-1/8"	4X2, 4X4	
		00-00	MANGUERA DE FRENOS	381163	CTR	16.89"	4X2	436
		00-00	MANGUERA DE FRENOS	381164	CTR	20.83"	4X4	436
		00-00	MANGUERA DE FRENOS	381169	DER	20.81"	4X2	437
		00-00	MANGUERA DE FRENOS	381170	IZQ	20.81"	4X2	437
		00-00	MANGUERA DE FRENOS	381187	DER	19.98"	4X4	437
	00-00	MANGUERA DE FRENOS	381188	IZQ	19.98"	4X4	437	
EXPEDITION		00-02	MANGUERA DE FRENOS	380356	DEL DER	21.5"		416
		97-99	MANGUERA DE FRENOS	380553	DEL IZQ	21"		425
		97-02	MANGUERA DE FRENOS	380554	DEL DER	21"		425
		97-99	MANGUERA DE FRENOS	380555	DEL IZQ	17.75"		425
		97-99	MANGUERA DE FRENOS	380556	DEL DER	43.25"		425
		97-99	MANGUERA DE FRENOS	380936	DEL INT	24.28"		429
		97-02	MANGUERA DE FRENOS	380937	TRAS IZQ	19"		429
		00-02	MANGUERA DE FRENOS	380939	TRAS DER	20.98"		429
		97-99	MANGUERA DE FRENOS	381119	TRAS DER	10.47"		434
		00-02	MANGUERA DE FRENOS	381338	DEL IZQ	19.5"		442
		00-01	MANGUERA DE FRENOS	381365	DEL IZQ	18.85"		444

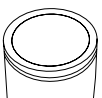



Modelo	Versión	Año	Descripción	Número Lusac	Posición	Diámetro	Notas	Foto Pág.	
EXPEDITION		03-06	MANGUERA DE FRENOS	382384	TRAS IZQ	21.5"	DS TAMBIÉN PUEDE LLEVAR LA MANGUERA TRASERA 382546 DEL 03 AL 04	462	
		03-06	MANGUERA DE FRENOS	382539	TRAS DER	19.5"		470	
		03-06	MANGUERA DE FRENOS	382684	DEL IZQ	24.5"		481	
		03-06	MANGUERA DE FRENOS	382685	DEL DER	24.5"		482	
		03-06	PISTÓN FRENO DE DISCO	85810	DEL	54.0 mm 2-1/8"		526	
		97-02	PISTÓN FRENO DE DISCO	85826	DEL	50.8 mm 2"	CALIPER DOBLE PISTON	527	
		97-02	PISTÓN FRENO DE DISCO	85827	TRAS	50.8 mm 2"		527	
		03-06	PISTÓN FRENO DE DISCO	850790	TRAS	52.0 mm 2-3/64"		530	
		03-06	REPUESTO FRENO DE DISCO	2079	TRAS	52.0 mm 2-3/64"		539	
		03-06	REPUESTO FRENO DE DISCO	2810	DEL	54.0 mm 2-1/8"		543	
		97-02	REPUESTO FRENO DE DISCO	2826	DEL	50.8 mm 2"	CALIPER DOBLE PISTON	544	
		97-02	REPUESTO FRENO DE DISCO	2827	TRAS	50.8 mm 2"		544	
		INLCUYE EDDIE BAUER	97-01	CILINDRO MAESTRO	390336		1-1/4"	S/C DE VELOCIDAD 4X2, 4X4	309
		INLCUYE EDDIE BAUER	97-02	CILINDRO MAESTRO	390337		1-1/4"	C/C DE VELOCIDAD 4X2, 4X4	309
		INLCUYE EDDIE BAUER	02-02	CILINDRO MAESTRO	390740		1-1/4"	S/C DE VELOCIDAD 4X2, 4X4	325
		INLCUYE EDDIE BAUER	97-02	REP. CIL. MAESTRO Y DE CLUTCH	90337		31.7 mm 1-1/4"		559
		XLT, EDDIE BAUER	03-06	CILINDRO MAESTRO	390337		1-1/4"	S/C DE VELOCIDAD 4X2	309
		XLT, EDDIE BAUER	03-06	REP. CIL. MAESTRO Y DE CLUTCH	90337		31.7 mm 1-1/4"		559
	EXPLORER		97-02	KIT DE PISTÓN Y REPUESTO FD	742378	DEL	50.8 mm 2"		
			97-02	KIT DE PISTÓN Y REPUESTO FD	742379	TRAS	50.8 mm 2"		
		03-04	MANGUERA DE FRENOS	382546	TRAS IZQ	21.19"		471	
		91-94	MANGUERA DE FRENOS	38813	TRAS IZQ	19.9"		397	
		91-91	MANGUERA DE FRENOS	38903	DEL DER	20.25"		402	
		91-91	MANGUERA DE FRENOS	38904	DEL IZQ	20.25"		402	
		92-92	MANGUERA DE FRENOS	380310	DEL IZQ	21"		412	
		92-92	MANGUERA DE FRENOS	380311	DEL DER	19.13"		412	
		93-94	MANGUERA DE FRENOS	380317	DEL DER	21.5"		413	
		93-94	MANGUERA DE FRENOS	380318	DEL IZQ	21"		413	
		95-97	MANGUERA DE FRENOS	380357	DEL DER	13.25"		416	
		95-97	MANGUERA DE FRENOS	380358	DEL IZQ	13.25"		416	
		95-97	MANGUERA DE FRENOS	380376	TRAS IZQ	27.75"		417	
		95-97	MANGUERA DE FRENOS	380528	TRAS DER	11"		424	
		11-14	MANGUERA DE FRENOS	382542	DEL IZQ	21"		471	
		11-14	MANGUERA DE FRENOS	382543	DEL DER	20.5"		471	
		91-94	PISTÓN FRENO DE DISCO	85055	DEL	66.7 mm 2-5/8"		519	
		95-97	PISTÓN FRENO DE DISCO	85456	TRAS	48.0 mm 1-57/64"		524	





Modelo	Versión	Año	Descripción	Número Lusac	Posición	Diámetro	Notas	Foto Pág.	
FORD									
EXPLORER		95-97	PISTÓN FRENO DE DISCO	85491	TRAS	48.0 mm 1-57/64"		525	
		95-97	PISTÓN FRENO DE DISCO	85857	DEL	46.0 mm 1-13/16"	CALIPER DOBLE PISTON	527	
		91-94	REPUESTO FRENO DE DISCO	1565	DEL	66.7 mm 2-5/8"		537	
		95-97	REPUESTO FRENO DE DISCO	2477	TRAS	48.0 mm 1-57/64"		541	
		95-97	REPUESTO FRENO DE DISCO	2857	DEL	46.0 mm 1-13/16"	CALIPER DOBLE PISTON	544	
	EDDIE BAUER		99-08	CILINDRO MAESTRO	390398		1-1/16"		312
	EDDIE BAUER		98-05	CILINDRO MAESTRO	390399		1-1/16"	S/C DE VELOCIDAD V8, 5.0 LTS	312
	EDDIE BAUER		98-02	CILINDRO MAESTRO	390400		1-1/16"	C/C DE VELOCIDAD V6, 4.8 LTS	312
	EDDIE BAUER		01-05	CILINDRO MAESTRO	390790		1-1/16"	ESTÁNDAR	328
	EDDIE BAUER		06-10	CILINDRO MAESTRO	391133		1-1/16"		344
	EDDIE BAUER		01-02	MANGUERA DE FRENOS	380376	TRAS DER	27.75"		417
	EDDIE BAUER		98-00	MANGUERA DE FRENOS	380376	TRAS IZQ	27.75"		417
	EDDIE BAUER		98-00	MANGUERA DE FRENOS	380528	TRAS DER	11"		424
	EDDIE BAUER		98-02	MANGUERA DE FRENOS	381157	DEL IZQ	11"		436
	EDDIE BAUER		98-02	MANGUERA DE FRENOS	381158	DEL IZQ	11"		436
	EDDIE BAUER		03-05	MANGUERA DE FRENOS	382536	DEL IZQ	20"		470
	EDDIE BAUER		03-05	MANGUERA DE FRENOS	382537	DEL DER	20"		470
	EDDIE BAUER		01-05	MANGUERA DE FRENOS	382538	TRAS IZQ	20"		470
	EDDIE BAUER		01-05	MANGUERA DE FRENOS	382539	TRAS DER	19.5"		470
	EDDIE BAUER		06-10	MANGUERA DE FRENOS	382540	TRAS DER	17.5"		470
	EDDIE BAUER		06-10	MANGUERA DE FRENOS	382541	TRAS IZQ	17.5"		470
	EDDIE BAUER		06-10	MANGUERA DE FRENOS	382542	DEL IZQ	21"		471
	EDDIE BAUER		06-10	MANGUERA DE FRENOS	382543	DEL DER	20.5"		471
	EDDIE BAUER		98-10	PISTÓN FRENO DE DISCO	85456	TRAS	48.0 mm 1-57/64"		524
	EDDIE BAUER		98-10	PISTÓN FRENO DE DISCO	85491	TRAS	48.0 mm 1-57/64"		525
	EDDIE BAUER		98-02	PISTÓN FRENO DE DISCO	85857	DEL	46.0 mm 1-13/16"	CALIPER DOBLE PISTON	527
	EDDIE BAUER		03-05	PISTÓN FRENO DE DISCO	850700	DEL	48.0 mm 1-57/64"	CALIPER DOBLE PISTON	529
	EDDIE BAUER		98-05	REP. CIL. MAESTRO Y DE CLUTCH	90398		26.9 mm 1-1/16"		559
	EDDIE BAUER		03-05	REPUESTO FRENO DE DISCO	2070	DEL	48.0 mm 1-57/64"	CALIPER DOBLE PISTON	539
	EDDIE BAUER		98-10	REPUESTO FRENO DE DISCO	2477	TRAS	48.0 mm 1-57/64"		541
	EDDIE BAUER		98-02	REPUESTO FRENO DE DISCO	2857	DEL	46.0 mm 1-13/16"	CALIPER DOBLE PISTON	544
	EDDIE BAUER		06-10	REPUESTO FRENO DE DISCO	21020	DEL	48.0 mm 1-57/64"		547





Modelo	Versión	Año	Descripción	Número Lusac	Posición	Diámetro	Notas	Foto Pág.	
EXPLORER	SPORT	01-02	CILINDRO DE RUEDA	370091	IZQ	7/8"		376	
	SPORT	01-02	CILINDRO DE RUEDA	370092	DER	7/8"		376	
	SPORT	94-95	CILINDRO MAESTRO	39953		1"		295	
	SPORT	98-00	CILINDRO MAESTRO	390398		1-1/16"		312	
	SPORT	98-03	CILINDRO MAESTRO	390399		1-1/16"	S/C DE VELOCIDAD	312	
	SPORT	98-03	CILINDRO MAESTRO	390400		1-1/16"	C/C DE VELOCIDAD	312	
	SPORT	03-03	CILINDRO MAESTRO	390790		1-1/16"	ESTÁNDAR	328	
	SPORT	98-03	MANGUERA DE FRENOS	380357	DEL DER	13.25"		416	
	SPORT	98-03	MANGUERA DE FRENOS	380358	DEL IZQ	13.25"		416	
	SPORT	98-03	MANGUERA DE FRENOS	380376	TRAS IZQ	27.75"		417	
	SPORT	98-03	MANGUERA DE FRENOS	380528	TRAS DER	11"		424	
	SPORT	94-95	PISTÓN FRENO DE DISCO	85456	TRAS	48.0 mm 1-57/64"		524	
	SPORT	98-03	PISTÓN FRENO DE DISCO	85456	TRAS	48.0 mm 1-57/64"		524	
	SPORT	94-95	PISTÓN FRENO DE DISCO	85491	TRAS	48.0 mm 1-57/64"		525	
	SPORT	98-03	PISTÓN FRENO DE DISCO	85491	TRAS	48.0 mm 1-57/64"		525	
	SPORT	94-95	PISTÓN FRENO DE DISCO	850700	DEL	48.0 mm 1-57/64"	CALIPER DOBLE PISTON	529	
	SPORT	98-03	PISTÓN FRENO DE DISCO	850700	DEL	48.0 mm 1-57/64"	CALIPER DOBLE PISTON	529	
	SPORT	94-95	REP. CIL. MAESTRO Y DE CLUTCH	9953		25.4 mm 1"		557	
	SPORT	98-00	REP. CIL. MAESTRO Y DE CLUTCH	90398		26.9 mm 1-1/16"		559	
	SPORT	94-95	REPUESTO FRENO DE DISCO	2070	DEL	48.0 mm 1-57/64"	CALIPER DOBLE PISTON	539	
	SPORT	98-03	REPUESTO FRENO DE DISCO	2070	DEL	48.0 mm 1-57/64"	CALIPER DOBLE PISTON	539	
	SPORT	94-95	REPUESTO FRENO DE DISCO	2477	TRAS	48.0 mm 1-57/64"		541	
	SPORT	98-03	REPUESTO FRENO DE DISCO	2477	TRAS	48.0 mm 1-57/64"		541	
	SPORT TRAC	01-03	CILINDRO DE RUEDA	370091	IZQ	7/8"		376	
	SPORT TRAC	01-03	CILINDRO DE RUEDA	370092	DER	7/8"		376	
	SPORT TRACK	07-10	CILINDRO MAESTRO	391133		1-1/16"	V8, 4X2	344	
	SPORT TRACK	07-10	MANGUERA DE FRENOS	382540	TRAS DER	17.5"		470	
	SPORT TRACK	07-10	MANGUERA DE FRENOS	382541	TRAS IZQ	17.5"		470	
	SPORT TRACK	07-14	MANGUERA DE FRENOS	382542	DEL IZQ	21"		471	
	SPORT TRACK	07-14	MANGUERA DE FRENOS	382543	DEL DER	20.5"		471	
	SPORT TRACK	07-10	REPUESTO FRENO DE DISCO	21020	DEL	48.0 mm 1-57/64"		547	
			91-91	CILINDRO DE CLUTCH	39904		19.0 mm 3/4"		
			93-94	CILINDRO DE CLUTCH	350055		15.8 mm 5/8"	NACIONAL	
			93-01	CILINDRO DE CLUTCH	360016		N/R		
			91-94	CILINDRO DE RUEDA	37856	DER	7/8"		367
			91-94	CILINDRO DE RUEDA	37856	IZQ	7/8"		367
			91-94	CILINDRO MAESTRO	39953		1"		295
			95-97	CILINDRO MAESTRO	390268		1-1/16"	C/C DE VELOCIDAD, SIN VAL/PROP.	306
			95-97	CILINDRO MAESTRO	390269		1-1/16"	S/C DE VELOCIDAD, SIN VAL/PROP.	306





Modelo	Versión	Año	Descripción	Número Lusac	Posición	Diámetro	Notas	Foto Pág.
FORD								
EXPLORER		95-97	CILINDRO MAESTRO	390313		1-1/16"	S/C DE VELOCIDAD, CON VAL/PROP.	308
		95-97	CILINDRO MAESTRO	390314		1-1/16"	C/C DE VELOCIDAD, CON VAL/PROP.	308
		02-05	CILINDRO MAESTRO	391045		1-1/16"		340
		91-94	KIT DE PISTÓN Y REPUESTO FD	742328	DEL	66.7 mm 2-5/8"		
		95-10	KIT DE PISTÓN Y REPUESTO FD	742374	TRAS	48.0 mm 1-57/64"		
		95-02	KIT DE PISTÓN Y REPUESTO FD	742380	DEL	46.0 mm 1-13/16"		
		94-05	KIT DE PISTÓN Y REPUESTO FD	742392	DEL	48.0 mm 1-57/64"		
		91-94	REP. CIL. MAESTRO Y DE CLUTCH	9953		25.4 mm 1"		557
	SPORT TRAC	01-02	MANGUERA DE FRENOS	381643	TRAS IZQ DER	20.63"	DISCO TAMBOR	452
F-100		92-92	CILINDRO DE CLUTCH	350033	SUP	22.2 mm 7/8"		
		93-95	CILINDRO DE CLUTCH	360014	INF	21.0 mm 53/64"		
		73-79	KIT DE PISTÓN Y REPUESTO FD	742335	DEL	73.0 mm 2-7/8"		
F-150		93-95	CILINDRO DE CLUTCH	350032	SUP	18.0 mm		
		92-92	CILINDRO DE CLUTCH	350033	SUP	22.2 mm 7/8"		
		93-95	CILINDRO DE CLUTCH	360014	INF	21.0 mm 53/64"		
		93-04	CILINDRO DE CLUTCH	360016		N/R		
		09-09	CILINDRO MAESTRO	391150		28.5 mm 1-1/8"		345
		06-10	KIT DE PISTÓN Y REPUESTO FD	742305	DEL	54.0 mm 2-1/8"		
		06-10	KIT DE PISTÓN Y REPUESTO FD	742306	TRAS	51.0 mm		
		97-04	KIT DE PISTÓN Y REPUESTO FD	742329	DEL	48.0 mm 1-57/64"		
		84-85	KIT DE PISTÓN Y REPUESTO FD	742335	DEL	73.0 mm 2-7/8"		
		90-91	KIT DE PISTÓN Y REPUESTO FD	742335	DEL	73.0 mm 2-7/8"		
		86-89	KIT DE PISTÓN Y REPUESTO FD	742336	DEL	73.0 mm 2-7/8"	CALIPER SENCILLO	
		92-93	KIT DE PISTÓN Y REPUESTO FD	742336	DEL	73.0 mm 2-7/8"	CALIPER SENCILLO	
		94-99	KIT DE PISTÓN Y REPUESTO FD	742352	DEL	73.0 mm 2-7/8"	8 V	
		97-99	KIT DE PISTÓN Y REPUESTO FD	742368	DEL	50.8 mm 2"		
		97-04	KIT DE PISTÓN Y REPUESTO FD	742376	DEL	48.0 mm 1-57/64"	CON CALIPER DE DOBLE PISTON	
		97-04	KIT DE PISTÓN Y REPUESTO FD	742379	TRAS	50.8 mm 2"		
		88-91	MANGUERA DE FRENOS	38867	TRAS	21.50"	CHOCOLATE	400
		99-03	MANGUERA DE FRENOS	382476	TRAS CENTRAL	27.5"	4X2	467
		99-04	MANGUERA DE FRENOS	382725	TRAS DER	10.44"	DISCO DISCO	485
		02-03	MANGUERA DE FRENOS	382726	TRAS IZQ	12.06"	DISCO DISCO	485
		84-91	MANGUERA DE FRENOS	4034	DEL DER	19 7/8"		385
		84-91	MANGUERA DE FRENOS	4035	DEL IZQ	19 3/4"		385
		92-96	MANGUERA DE FRENOS	38899	DEL DER	20.88"		401
	92-96	MANGUERA DE FRENOS	38900	DEL IZQ	20.88"		402	
	94-96	MANGUERA DE FRENOS	380046	TRAS IZQ	21.36"		405	
	92-95	MANGUERA DE FRENOS	380196	TRAS IZQ	18"		408	
	97-99	MANGUERA DE FRENOS	380196	TRAS IZQ	18"		408	

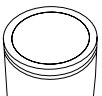

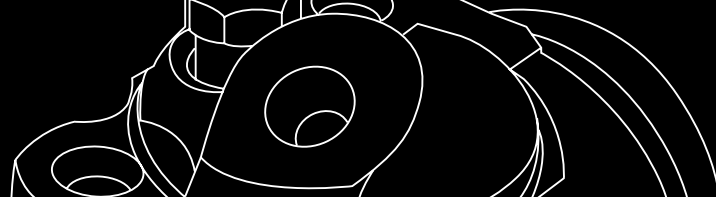

Modelo	Versión	Año	Descripción	Número Lusac	Posición	Diámetro	Notas	Foto Pág.	
F-150		94-95	MANGUERA DE FRENOS	380298	DEL DER	19.5"		411	
		94-95	MANGUERA DE FRENOS	380299	DEL IZQ	19"		411	
		97-03	MANGUERA DE FRENOS	380553	DEL IZQ	21"	DS DEL 99 AL 03 PUEDE LLEVAR LA MANGUERA CENTRAL 382476	425	
		97-03	MANGUERA DE FRENOS	380554	DEL DER	21"		425	
		97-03	MANGUERA DE FRENOS	380935	TRAS DER	21.78"		429	
		97-03	MANGUERA DE FRENOS	380935	TRAS IZQ	21.78"	DS TAMBIÉN PUEDE LLEVAR LA MANGUERA CENTRAL 380935	429	
		00-03	MANGUERA DE FRENOS	382300	TRAS IZQ	27.1"		454	
		84-91	MANGUERA DE FRENOS	7838625	TRAS IZQ	17 7/8"		516	
		84-93	PISTÓN FRENO DE DISCO	76024	DEL	73.0 mm 2-7/8"		518	
		97-99	PISTÓN FRENO DE DISCO	85013	DEL	50.8 mm 2"	CALIPER DOBLE PISTON	518	
		94-99	PISTÓN FRENO DE DISCO	85019	DEL	73.0 mm 2-7/8"		518	
		97-03	PISTÓN FRENO DE DISCO	85477	DEL	48.0 mm 1-57/64"	CALIPER DOBLE PISTON	525	
		97-03	PISTÓN FRENO DE DISCO	85817	DEL	48.0 mm 1-57/64"		527	
		97-03	PISTÓN FRENO DE DISCO	85827	TRAS	50.8 mm 2"		527	
		86-89	REPUESTO FRENO DE DISCO	1838	DEL	73.0 mm 2-7/8"		538	
		92-99	REPUESTO FRENO DE DISCO	1838	DEL	73.0 mm 2-7/8"		538	
		97-03	REPUESTO FRENO DE DISCO	2817	DEL	48.0 mm 1-57/64"	CALIPER DOBLE PISTON	544	
		97-03	REPUESTO FRENO DE DISCO	2827	DEL	50.8 mm 2"		544	
		84-85	REPUESTO FRENO DE DISCO	76090	DEL	73.0 mm 2-7/8"		552	
		90-91	REPUESTO FRENO DE DISCO	76090	DEL	73.0 mm 2-7/8"		552	
		XL	04-04	CILINDRO DE RUEDA	78974	IZQ	25.4 mm 1"		370
		XL	04-04	CILINDRO DE RUEDA	78975	DER	25.4 mm 1"		371
		XL	04-12	CILINDRO MAESTRO	390811		1-1/8"		329
		XL	04-04	MANGUERA DE FRENOS	380553	DEL IZQ	21"		425
		XL	04-04	MANGUERA DE FRENOS	380554	DEL DER	21"		425
		XL	04-04	MANGUERA DE FRENOS	380935	TRAS IZQ	21.78"		429
		XL	04-10	MANGUERA DE FRENOS	382727	TRAS IZQ	11.62"		485
		XL	04-04	PISTÓN FRENO DE DISCO	85477	DEL	48.0 mm 1-57/64"	CALIPER DOBLE PISTON	525
		XL	04-04	PISTÓN FRENO DE DISCO	85827	TRAS	50.8 mm 2"		527
		XL	05-10	PISTÓN FRENO DE DISCO	851024	DEL	54.0 mm 2-1/8"	CALIPER DOBLE PISTON	531
		XL	05-10	PISTÓN FRENO DE DISCO	851025	TRAS	51.0 mm		531
		XL	04-04	REPUESTO FRENO DE DISCO	2817	DEL	48.0 mm 1-57/64"	CALIPER DOBLE PISTON	544
		XL	04-04	REPUESTO FRENO DE DISCO	2827	DEL	50.8 mm 2"		544
		XL	05-10	REPUESTO FRENO DE DISCO	21024	DEL	54.0 mm 2-1/8"	CALIPER DOBLE PISTON	547
		XL	05-10	REPUESTO FRENO DE DISCO	21025	TRAS	51.0 mm		547
			87-99	CILINDRO DE RUEDA	59240	IZQ	23.8 mm 15/16"		370
		87-99	CILINDRO DE RUEDA	59241	DER	23.8 mm 15/16"		370	

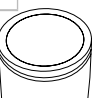



Modelo	Versión	Año	Descripción	Número Lusac	Posición	Diámetro	Notas	Foto Pág.
FORD								
F-150		84-86	CILINDRO DE RUEDA	78974	IZQ	25.4 mm 1"		370
		97-03	CILINDRO DE RUEDA	78974	IZQ	25.4 mm 1"		370
		84-86	CILINDRO DE RUEDA	78975	DER	25.4 mm 1"		371
		97-03	CILINDRO DE RUEDA	78975	DER	25.4 mm 1"		371
		84-86	CILINDRO MAESTRO	97934		25.4 mm 1"		
		87-99	CILINDRO MAESTRO	120369		26.9 mm 1-1/16"	S/C DE VELOCIDAD	298
		94-95	CILINDRO MAESTRO	390183		1-1/8"	C/C DE VELOCIDAD	302
		97-99	CILINDRO MAESTRO	390183		1-1/8"	C/C DE VELOCIDAD	302
		00-03	CILINDRO MAESTRO	390336		1-1/4"	S/C DE VELOCIDAD V6	309
		00-01	CILINDRO MAESTRO	390337		1-1/4"		309
		00-03	CILINDRO MAESTRO	390695		1-1/16"	DISCO-TAMBOR S/C DE VELOCIDAD	323
		03-03	CILINDRO MAESTRO	390820		1-3/16"		330
		00-01	CILINDRO MAESTRO	391041		1-1/16"		340
		00-01	REP. CIL. MAESTRO Y DE CLUTCH	90337		31.7 mm 1-1/4"		559
		84-86	REP. CIL. MAESTRO Y DE CLUTCH	97935		25.4 mm 1"		
		87-99	REPUESTO CILINDRO DE RUEDA	114084		26.9 mm 1-1/16"		561
F-200		86-86	KIT DE PISTÓN Y REPUESTO FD	742336	DEL	73.0 mm 2-7/8"	CALIPER SENCILLO	
		86-91	KIT DE PISTÓN Y REPUESTO FD	742341	DEL	55.6 mm 2-3/16"		
		89-91	MANGUERA DE FRENOS	38898	DEL	23.75"		401
		86-86	MANGUERA DE FRENOS	4034	DEL DER	19 7/8"		385
		86-86	MANGUERA DE FRENOS	4035	DEL IZQ	19 3/4"		385
		86-91	MANGUERA DE FRENOS	4036	DEL DER	18 1/2"		385
		86-91	MANGUERA DE FRENOS	4036	DEL IZQ	18 1/2"		385
		86-86	MANGUERA DE FRENOS	38332	TRAS IZQ	19.25"		
		86-86	MANGUERA DE FRENOS	38339	TRAS IZQ	19.63"		
		87-91	MANGUERA DE FRENOS	7838625	TRAS IZQ	17 7/8"		516
		86-86	PISTÓN FRENO DE DISCO	76024	DEL	73.0 mm 2-7/8"		518
		86-91	PISTÓN FRENO DE DISCO	99980	DEL	55.6 mm 2-3/16"		528
		86-86	REPUESTO FRENO DE DISCO	1838	DEL	73.0 mm 2-7/8"		538
		86-91	REPUESTO FRENO DE DISCO	88562D	DEL	55.6 mm 2-3/16"		555
		87-89	CILINDRO DE RUEDA	35325	IZQ	28.5 mm 1-1/8"		
		87-89	CILINDRO DE RUEDA	35326	DER	28.5 mm 1-1/8"		
		86-86	CILINDRO DE RUEDA	57146	IZQ	25.4 mm 1"		370
		86-86	CILINDRO DE RUEDA	57147	DER	25.4 mm 1"		370
		86-86	CILINDRO DE RUEDA	78974	IZQ	25.4 mm 1"		370
		90-91	CILINDRO DE RUEDA	78974	IZQ	25.4 mm 1"		370
		86-86	CILINDRO DE RUEDA	78975	DER	25.4 mm 1"		371
		90-91	CILINDRO DE RUEDA	78975	DER	25.4 mm 1"		371
		90-91	CILINDRO DE RUEDA	113757	IZQ	30.1 mm 1-3/16"		373
		90-91	CILINDRO DE RUEDA	113758	DER	30.1 mm 1-3/16"		373
	86-86	CILINDRO MAESTRO	110919		28.5 mm 1-1/8"	1ª VERSION, 2ª VERSION		
	87-91	CILINDRO MAESTRO	114079		28.5 mm 1-1/8"	1ª VERSION, 2ª VERSION	298	
	87-91	CILINDRO MAESTRO	120369		26.9 mm 1-1/16"	1ª VERSION, 2ª VERSION	298	
	86-86	REP. CIL. MAESTRO Y DE CLUTCH	110920		28.5 mm 1-1/8"			

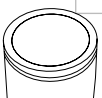



Modelo	Versión	Año	Descripción	Número Lusac	Posición	Diámetro	Notas	Foto Pág.	
F-250		87-91	REP. CIL. MAESTRO Y DE CLUTCH	114085		28.5 mm 1-1/8"		561	
		87-91	REPUESTO CILINDRO DE RUEDA	114084		26.9 mm 1-1/16"		561	
		93-97	CILINDRO DE CLUTCH	350032	SUP	18.0 mm			
		92-92	CILINDRO DE CLUTCH	350033	SUP	22.2 mm 7/8"			
		93-95	CILINDRO DE CLUTCH	360014	INF	21.0 mm 53/64"			
		93-01	CILINDRO DE CLUTCH	360016		N/R			
		99-05	CILINDRO DE CLUTCH	360108		21.0 mm 53/64"			
		99-05	CILINDRO DE CLUTCH	360109		21.0 mm			
		11-12	CILINDRO MAESTRO	391161		33.3 mm 1-5/16"	CON BOOSTER		
		11-12	CILINDRO MAESTRO	391163		38.1 mm 1-1/2"	CON HIDRO-BOOSTER		
		99-05	KIT DE PISTÓN Y REPUESTO FD	742330	DEL TRAS	54.0 mm 2-1/8"			
		95-97	KIT DE PISTÓN Y REPUESTO FD	742338	DEL	55.9 mm 2-13/64"			
		92-94	KIT DE PISTÓN Y REPUESTO FD	742342	DEL	55.6 mm 2-3/16"			
		92-94	KIT DE PISTÓN Y REPUESTO FD	742343	DEL	55.6 mm 2-3/16"			
		03-04	KIT DE PISTÓN Y REPUESTO FD	742368	DEL	50.8 mm 2"	4X4		
		98-02	KIT DE PISTÓN Y REPUESTO FD	742378	DEL	50.8 mm 2"	CON CALIPER DE DOBLE PISTON		
		97-04	KIT DE PISTÓN Y REPUESTO FD	742379	TRAS	50.8 mm 2"			
		89-96	MANGUERA DE FRENOS	38898	DEL	23.75"		401	
		95-98	MANGUERA DE FRENOS	380353	DEL IZQ	21"		415	
		95-98	MANGUERA DE FRENOS	380354	DEL DER	20.25"		415	
		97-99	MANGUERA DE FRENOS	381062	TRAS DER	10.47"	CHOCOLATE	432	
		99-04	MANGUERA DE FRENOS	381189	DEL IZQ A LAS RUEDAS TRASERAS	19.98"		438	
		92-94	MANGUERA DE FRENOS	4036	DEL DER	18 1/2"		385	
		92-94	MANGUERA DE FRENOS	38897	DEL IZQ	18.75"		401	
		92-96	MANGUERA DE FRENOS	380196	TRAS IZQ	18"		408	
		95-97	MANGUERA DE FRENOS	380383	DEL DER	16.75"		418	
		95-97	MANGUERA DE FRENOS	380384	DEL IZQ	20"		418	
		07-07	MANGUERA DE FRENOS	382686	DEL DER	21.75"	DS 4X2	482	
		07-07	MANGUERA DE FRENOS	382687	DEL IZQ	21.25"	DS 4X2	482	
		07-07	MANGUERA DE FRENOS	382703	DEL IZQ	21.5"		483	
		09-09	MANGUERA DE FRENOS	382703	DEL IZQ	21.5"		483	
		07-07	MANGUERA DE FRENOS	382704	DEL DER	21.5"		483	
		09-09	MANGUERA DE FRENOS	382704	DEL DER	21.5"		483	
		09-12	MANGUERA DE FRENOS	382705	DEL IZQ	26"		484	
		09-12	MANGUERA DE FRENOS	382706	DEL DER	26"		484	
		07-07	MANGUERA DE FRENOS	382727	TRAS IZQ	11.62"		485	
		92-94	PISTÓN FRENO DE DISCO	99980	DEL	55.6 mm 2-3/16"		528	
		95-97	PISTÓN FRENO DE DISCO	850300	DEL	55.9 mm 2-13/64"	CALIPER DOBLE PISTON	529	
		92-94	REPUESTO FRENO DE DISCO	2730	DEL	55.6 mm 2-3/16"		542	
		95-97	REPUESTO FRENO DE DISCO	2885	DEL	55.9 mm 2-13/64"	CALIPER DOBLE PISTON	545	
		SUPER DUTY, XL , XLT	07-07	CILINDRO MAESTRO	390957		1-5/16"		336
		SUPER DUTY, XL , XLT	07-07	CILINDRO MAESTRO	391043		1-5/16"		340





Modelo	Versión	Año	Descripción	Número Lusac	Posición	Diámetro	Notas	Foto Pág.
FORD								
F-250	SUPER DUTY, XL , XLT	09-11	CILINDRO MAESTRO	391195		1-5/16"		348
	SUPER DUTY, XL , XLT	09-11	CILINDRO MAESTRO	391197		1-1/2"		348
	SUPER DUTY, XL , XLT	09-09	CILINDRO MAESTRO	391198		1-3/8"		349
	XL	97-02	CILINDRO DE RUEDA	78974	IZQ	25.4 mm 1"		370
	XL	97-02	CILINDRO DE RUEDA	78975	DER	25.4 mm 1"		371
	XL	97-02	CILINDRO MAESTRO	390336		1-1/4"	S/C DE VELOCIDAD, DISCO TRASERO	309
	XL	98-02	CILINDRO MAESTRO	390337		1-1/4"	C/C DE VELOCIDAD, DISCO TRASERO	309
	XL	01-02	CILINDRO MAESTRO	390338		1-1/4"	C/C DE VELOCIDAD, TAMBOR TRASERO	309
	XL	97-02	CILINDRO MAESTRO	390339		1-1/4"	S/C DE VELOCIDAD, TAMBOR TRASERO	310
	XL	99-04	CILINDRO MAESTRO	390530		1-3/8"	S/C DE VELOCIDAD 4X2, 4X4	317
	XL	99-04	CILINDRO MAESTRO	390531		1-3/8"	S/C DE VELOCIDAD 4X2, 4X4	317
	XL	05-08	CILINDRO MAESTRO	390957		1-5/16"		336
	XL	05-08	CILINDRO MAESTRO	391043		1-5/16"		340
	XL	09-11	CILINDRO MAESTRO	391195		1-5/16"		348
	XL	09-11	CILINDRO MAESTRO	391197		1-1/2"		348
	XL	09-11	CILINDRO MAESTRO	391198		1-3/8"		349
	XL	09-11	CILINDRO MAESTRO	391200		1-1/2"		349
	XL	98-00	MANGUERA DE FRENOS	380196	TRAS IZQ	18"		408
	XL	98-99	MANGUERA DE FRENOS	380553	DEL	21"		425
	XL	98-02	MANGUERA DE FRENOS	380554	DEL	21"		425
	XL	97-04	MANGUERA DE FRENOS	381163	TRAS DER	16.89"		436
	XL	97-04	MANGUERA DE FRENOS	381163	TRAS IZQ	16.89"		436
	XL	99-04	MANGUERA DE FRENOS	381167	TRAS DER	18.35"		437
	XL	99-04	MANGUERA DE FRENOS	381167	TRAS IZQ	18.35"		437
	XL	97-04	MANGUERA DE FRENOS	381169	DEL DER	20.81"		437
	XL	97-04	MANGUERA DE FRENOS	381170	DEL IZQ	20.81"		437
	XL	99-04	MANGUERA DE FRENOS	381185	DEL IZQ	25"		437
	XL	99-04	MANGUERA DE FRENOS	381187	DEL DER	19.98"	DS 4X4	437
	XL	99-04	MANGUERA DE FRENOS	381188	DEL IZQ	19.98"	DS 4X4	437
	XL	03-04	MANGUERA DE FRENOS	381280	DEL IZQ	10.63"		439
	XL	98-02	MANGUERA DE FRENOS	381338	DEL IZQ	19.5"		442
	XL	05-07	MANGUERA DE FRENOS	382686	DEL IZQ	21.75"		482
	XL	05-07	MANGUERA DE FRENOS	382687	DEL DER	21.25"		482
	XL	09-11	MANGUERA DE FRENOS	382703	DEL IZQ	21.5"		483
	XL	09-11	MANGUERA DE FRENOS	382704	DEL DER	21.5"		483
	XL	09-11	MANGUERA DE FRENOS	382705	DEL IZQ	26"		484
	XL	09-11	MANGUERA DE FRENOS	382706	DEL DER	26"		484
	XL	03-04	PISTÓN FRENO DE DISCO	85013	DEL	50.8 mm 2"	CALIPER DOBLE PISTON	518
	XL	99-04	PISTÓN FRENO DE DISCO	85815	DEL	54.0 mm 2-1/8"	CALIPER DOBLE PISTON	526
	XL	97-02	PISTÓN FRENO DE DISCO	85826	DEL	50.8 mm 2"	CALIPER DOBLE PISTON	527
	XL	97-04	PISTÓN FRENO DE DISCO	85827	TRAS	50.8 mm 2"		527
	XL	98-02	REP. CIL. MAESTRO Y DE CLUTCH	90337		31.7 mm 1-1/4"		559
XL	99-04	REPUESTO FRENO DE DISCO	2815	DEL	54.0 mm 2-1/8"	CALIPER DOBLE PISTON	544	

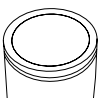



Modelo	Versión	Año	Descripción	Número Lusac	Posición	Diámetro	Notas	Foto Pág.
F-250	XL	97-02	REPUESTO FRENO DE DISCO	2826	DEL	50.8 mm 2"	CALIPER DOBLE PISTON	544
	XL	97-04	REPUESTO FRENO DE DISCO	2827	DEL	50.8 mm 2"		544
		92-92	CILINDRO DE RUEDA	78974	IZQ	25.4 mm 1"		370
		94-94	CILINDRO DE RUEDA	78974	IZQ	25.4 mm 1"		370
		92-92	CILINDRO DE RUEDA	78975	DER	25.4 mm 1"		371
		94-94	CILINDRO DE RUEDA	78975	DER	25.4 mm 1"		371
		92-93	CILINDRO DE RUEDA	113757	DER	30.1 mm 1-3/16"		373
		95-97	CILINDRO DE RUEDA	113757	DER	30.1 mm 1-3/16"		373
		92-93	CILINDRO DE RUEDA	113758	IZQ	30.1 mm 1-3/16"		373
		95-97	CILINDRO DE RUEDA	113758	IZQ	30.1 mm 1-3/16"		373
		94-94	CILINDRO MAESTRO	39635		1-1/8"		294
		96-96	CILINDRO MAESTRO	39635		1-1/8"	C/C DE VELOCIDAD	294
		92-93	CILINDRO MAESTRO	114079		28.5 mm 1-1/8"		298
		92-92	CILINDRO MAESTRO	120369		26.9 mm 1-1/16"		298
		95-95	CILINDRO MAESTRO	390184		1-1/8"	C/C DE VELOCIDAD	302
		96-97	CILINDRO MAESTRO	390337		1-1/4"	C/C DE VELOCIDAD, 4X4	309
		97-97	CILINDRO MAESTRO	390339		1-1/4"	S/C DE VELOCIDAD	310
		96-97	CILINDRO MAESTRO	390961		1-1/4"	S/C DE CRUCERO 4X2	336
		96-97	REP. CIL. MAESTRO Y DE CLUTCH	90337		31.7 mm 1-1/4"		559
		92-96	REP. CIL. MAESTRO Y DE CLUTCH	114085		28.5 mm 1-1/8"		561
	92-92	REPUESTO CILINDRO DE RUEDA	114084		26.9 mm 1-1/16"		561	
F-300		93-97	CILINDRO DE CLUTCH	350032	SUP	18.0 mm		
		92-92	CILINDRO DE CLUTCH	350033	SUP	22.2 mm 7/8"		
		93-95	CILINDRO DE CLUTCH	360014	INF	21.0 mm 53/64"		
		93-98	CILINDRO DE CLUTCH	360016		N/R	NACIONAL	
		90-94	MANGUERA DE FRENOS	38898	DEL	23.75"	CHOCOLATE	401
		95-97	MANGUERA DE FRENOS	380353	DEL IZQ	21"		415
		95-97	MANGUERA DE FRENOS	380354	DEL DER	20.25"	CHOCOLATE	415
F-350		92-97	CILINDRO DE CLUTCH	350032	SUP	18.0 mm	NACIONAL	
		92-92	CILINDRO DE CLUTCH	350033	SUP	22.2 mm 7/8"	NACIONAL	
		93-95	CILINDRO DE CLUTCH	360014	INF	21.0 mm 53/64"		
		93-98	CILINDRO DE CLUTCH	360016		N/R	NACIONAL	
		98-05	CILINDRO DE CLUTCH	360108		21.0 mm 53/64"		
		98-05	CILINDRO DE CLUTCH	360109		21.0 mm		
		08-12	CILINDRO MAESTRO	391161		33.3 mm 1-5/16"	CON BOOSTER	
		08-14	CILINDRO MAESTRO	391163		38.1 mm 1-1/2"	CON HIDRO-BOOSTER	
		99-04	KIT DE PISTÓN Y REPUESTO FD	742330	DEL TRAS	54.0 mm 2-1/8"	CON CALIPER DE DOBLE PISTON	
		95-04	KIT DE PISTÓN Y REPUESTO FD	742338	DEL	55.9 mm 2-13/64"		
		73-92	KIT DE PISTÓN Y REPUESTO FD	742341	DEL	55.6 mm 2-3/16"		
		93-94	KIT DE PISTÓN Y REPUESTO FD	742342	DEL	55.6 mm 2-3/16"		
		93-94	KIT DE PISTÓN Y REPUESTO FD	742343	DEL	55.6 mm 2-3/16"		
	05-11	KIT DE PISTÓN Y REPUESTO FD	742354	DEL	60.0 mm			
	05-11	KIT DE PISTÓN Y REPUESTO FD	742355	TRAS	54.0 mm 2-1/8"			





Modelo	Versión	Año	Descripción	Número Lusac	Posición	Diámetro	Notas	Foto Pág.
FORD								
F-350		12-13	KIT DE PISTÓN Y REPUESTO FD	742438	DEL	60.0 mm	CON CALIPER DE DOBLE PISTON CUBREPOLVO DURO	
		12-13	KIT DE PISTÓN Y REPUESTO FD	742438	DEL	60.0 mm		
		95-97	MANGUERA DE FRENOS	380353	DEL IZQ	21"	CHOCOLATE	415
		95-97	MANGUERA DE FRENOS	380354	DEL DER	20.25"	CHOCOLATE	415
		99-04	MANGUERA DE FRENOS	381189	DEL IZQ A LAS RUEDAS TRASERAS	19.98"	4X4 C/ABS	438
		84-94	MANGUERA DE FRENOS	4036	DEL DER	18 1/2"		385
		84-89	MANGUERA DE FRENOS	4036	DEL IZQ	18 1/2"		385
		87-89	MANGUERA DE FRENOS	38044	TRAS IZQ	19.88"		
		84-92	MANGUERA DE FRENOS	38631	TRAS IZQ	20.13"		
		84-94	MANGUERA DE FRENOS	38897	DEL IZQ	18.75"		401
		93-04	MANGUERA DE FRENOS	380196	TRAS IZQ	18"		408
		95-98	MANGUERA DE FRENOS	380383	DEL DER	16.75"		418
		95-98	MANGUERA DE FRENOS	380384	DEL IZQ	20"		418
		99-04	MANGUERA DE FRENOS	381165	TRAS DER	16"		436
		99-04	MANGUERA DE FRENOS	381165	TRAS IZQ	16"		436
		99-04	MANGUERA DE FRENOS	381167	TRAS IZQ	18.35"		437
		99-04	MANGUERA DE FRENOS	381169	DEL DER	20.81"		437
		99-04	MANGUERA DE FRENOS	381169	TRAS DER	20.81"		437
		99-04	MANGUERA DE FRENOS	381170	DEL IZQ	20.81"		437
		99-04	MANGUERA DE FRENOS	381184	DEL IZQ	17.98"		437
		99-04	MANGUERA DE FRENOS	381186	TRAS DER	17.98"		437
		99-04	MANGUERA DE FRENOS	381187	DEL DER	19.98"	DS 4X4	437
		99-04	MANGUERA DE FRENOS	381188	DEL IZQ	19.98"	DS 4X4	437
		05-07	MANGUERA DE FRENOS	382686	DEL IZQ	21.75"		482
		05-07	MANGUERA DE FRENOS	382687	DEL DER	21.25"		482
		08-10	MANGUERA DE FRENOS	382703	DEL IZQ	21.5"	DS TAMBIÉN PUEDE LLEVAR EN EL 2011 LAS MANGUERAS 382936 IZQ BH382888 DER, BH382770 IZE 382771 DER	483
		08-10	MANGUERA DE FRENOS	382704	DEL DER	21.5"		483
		08-12	MANGUERA DE FRENOS	382705	DEL IZQ	26"		484
		08-12	MANGUERA DE FRENOS	382706	DEL DER	26"		484
		84-86	MANGUERA DE FRENOS	7838625	TRAS IZQ	17 7/8"		516
		99-04	PISTÓN FRENO DE DISCO	85815	TRAS	54.0 mm 2-1/8"	CALIPER DOBLE PISTON	526
		84-94	PISTÓN FRENO DE DISCO	99980	DEL	55.6 mm 2-3/16"		528
	95-04	PISTÓN FRENO DE DISCO	850300	DEL	55.9 mm 2-13/64"	CALIPER DOBLE PISTON	529	
	99-04	PISTÓN FRENO DE DISCO	850810	TRAS	44.4 mm 1-3/4"	CALIPER DOBLE PISTON	530	
	13-14	PISTÓN FRENO DE DISCO	851056	DEL	60.0 mm	CALIPER DOBLE PISTON	533	
	11-12	PISTÓN FRENO DE DISCO	851059	DEL	60.0 mm	CALIPER DOBLE PISTON		
	99-04	REPUESTO FRENO DE DISCO	2081	TRAS	44.4 mm 1-3/4"	CALIPER DOBLE PISTON		
	93-94	REPUESTO FRENO DE DISCO	2730	DEL	55.6 mm 2-3/16"		542	
	99-04	REPUESTO FRENO DE DISCO	2815	TRAS	54.0 mm 2-1/8"	CALIPER DOBLE PISTON	544	

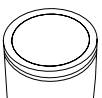



Modelo	Versión	Año	Descripción	Número Lusac	Posición	Diámetro	Notas	Foto Pág.	
F-350		97-98	REPUESTO FRENO DE DISCO	2885	DEL	55.9 mm 2-13/64"		545	
		95-04	REPUESTO FRENO DE DISCO	2885	DEL	55.9 mm 2-13/64"	CALIPER DOBLE PISTON	545	
		13-14	REPUESTO FRENO DE DISCO	108241	DEL	60.0 mm	CALIPER DOBLE PISTON	554	
		05-12	REPUESTO FRENO DE DISCO	21022	TRAS	54.0 mm 2-1/8"	CALIPER DOBLE PISTON	547	
		05-12	REPUESTO FRENO DE DISCO	21023	DEL	60.0 mm	CALIPER DOBLE PISTON	547	
		11-12	REPUESTO FRENO DE DISCO	21059	DEL	60.0 mm	CALIPER DOBLE PISTON	549	
		13-14	REPUESTO FRENO DE DISCO	108241	DEL	60.0 mm	CALIPER DOBLE PISTON	554	
		84-92	REPUESTO FRENO DE DISCO	88562D	DEL	55.6 mm 2-3/16"		555	
		SUPER DUTY, XL, XLT	99-04	CILINDRO DE RUEDA	113757	DER	30.1 mm 1-3/16"		373
		SUPER DUTY, XL, XLT	99-04	CILINDRO DE RUEDA	113758	IZQ	30.1 mm 1-3/16"		373
		SUPER DUTY, XL, XLT	99-07	CILINDRO MAESTRO	390337		1-1/4"	C/C DE VELOCIDAD, DOBLE RODADA SUPER DUTY, XL V8, TRITON	309
		SUPER DUTY, XL, XLT	05-07	CILINDRO MAESTRO	390530		1-3/8"	C/C DE VELOCIDAD SUPER DUTY, XL V8, TRITON	317
		SUPER DUTY, XL, XLT	99-07	CILINDRO MAESTRO	390531		1-3/8"	S/C DE VELOCIDAD V8, TRITON	317
		SUPER DUTY, XL, XLT	99-07	REP. CIL. MAESTRO Y DE CLUTCH	90337		31.7 mm 1-1/4"		559
		SUPER DUTY, XL, XLT	99-04	REP. CIL. MAESTRO Y DE CLUTCH	903380		31.7 mm 1-1/4"		
			84-86	CILINDRO DE RUEDA	35325	IZQ	28.5 mm 1-1/8"		
			84-86	CILINDRO DE RUEDA	35326	DER	28.5 mm 1-1/8"		
			87-89	CILINDRO DE RUEDA	40951	IZQ	28.5 mm 1-1/8"		
			87-89	CILINDRO DE RUEDA	40952	DER	28.5 mm 1-1/8"		
			84-92	CILINDRO DE RUEDA	57146	IZQ	25.4 mm 1"		370
			84-92	CILINDRO DE RUEDA	57147	DER	25.4 mm 1"		370
			90-98	CILINDRO DE RUEDA	113757	DER	30.1 mm 1-3/16"		373
			90-98	CILINDRO DE RUEDA	113758	IZQ	30.1 mm 1-3/16"		373
			97-98	CILINDRO DE RUEDA	370042	IZQ	28.5 mm 1-1/8"		374
			97-98	CILINDRO DE RUEDA	370043	DER	28.5 mm 1-1/8"		374
			94-94	CILINDRO MAESTRO	39635		1-1/8"	S/C DE VELOCIDAD, DOBLE RODADA	294
			84-86	CILINDRO MAESTRO	110919		28.5 mm 1-1/8"	DOBLE RODADA	
			87-93	CILINDRO MAESTRO	114079		28.5 mm 1-1/8"	DOBLE RODADA	298
			84-92	CILINDRO MAESTRO	114079		28.5 mm 1-1/8"	RODADA SENCILLA	298
			94-94	CILINDRO MAESTRO	390184		1-1/8"	C/C DE VELOCIDAD, DOBLE RODADA	302
			95-96	CILINDRO MAESTRO	390336		1-1/4"	DOBLE RODADA	309
			95-98	CILINDRO MAESTRO	390337		1-1/4"	C/C DE VELOCIDAD, DOBLE RODADA	309
			97-98	CILINDRO MAESTRO	390339		1-1/4"	S/C DE VELOCIDAD, RODADA SENCILLA	310
		96-97	CILINDRO MAESTRO	390961		1-1/4"	S/C CRUCERO 4X2	336	
		95-98	REP. CIL. MAESTRO Y DE CLUTCH	90337		31.7 mm 1-1/4"		559	





Modelo	Versión	Año	Descripción	Número Lusac	Posición	Diámetro	Notas	Foto Pág.
FORD								
F-350		84-86	REP. CIL. MAESTRO Y DE CLUTCH	110920		28.5 mm 1-1/8"		
		84-94	REP. CIL. MAESTRO Y DE CLUTCH	114085		28.5 mm 1-1/8"		561
		97-98	REP. CIL. MAESTRO Y DE CLUTCH	903380		31.7 mm 1-1/4"		
F-450		99-01	CILINDRO DE CLUTCH	360108		21.0 mm 53/64"		
		99-04	CILINDRO DE CLUTCH	360109		21.0 mm		
		11-12	CILINDRO MAESTRO	391161		33.3 mm 1-5/16"	CON BOOSTER	
		11-12	CILINDRO MAESTRO	391163		38.1 mm 1-1/2"	CON HIDROBOOSTER CON CONTROL DE FRENOS DE REMOLQUE	
		11-12	CILINDRO MAESTRO	391196		38.1 mm 1-1/2"	CON HIDROBOOSTER	
		99-13	KIT DE PISTÓN Y REPUESTO FD	742350	DEL TRAS	59.5 mm 2-11/32"		
		97-02	KIT DE PISTÓN Y REPUESTO FD	742353	TRAS	59.5 mm 2-11/32"	8 V CON CALIPER DE DOBLE PISTON CUBREPOLVO SUAVE	
		11-11	KIT DE PISTÓN Y REPUESTO FD	742354	DEL	60.0 mm	CON CALIPER DE DOBLE PISTON CUBREPOLVO SUAVE	
		11-11	KIT DE PISTÓN Y REPUESTO FD	742355	TRAS	54.0 mm 2-1/8"	CON CALIPER DE DOBLE PISTON CUBREPOLVO DURO	
		99-06	MANGUERA DE FRENOS	381168	TRAS IZQ DER	17.37"		437
		05-07	MANGUERA DE FRENOS	382690	TRAS CENTRAL	21"		482
		97-98	MANGUERA DE FRENOS	38947	DEL DER	24.63"		402
		97-98	MANGUERA DE FRENOS	38950	DEL IZQ	24.63"		402
		97-98	MANGUERA DE FRENOS	380375	TRAS DER	47.5"		417
		97-98	MANGUERA DE FRENOS	380920	TRAS IZQ	10.9"		429
		99-04	MANGUERA DE FRENOS	381262	DEL DER	26"		438
		99-04	MANGUERA DE FRENOS	381263	DEL IZQ	26"		438
		05-10	MANGUERA DE FRENOS	382688	DEL IZQ	23"	DS TAMBIÉN PUEDE LLEVAR LA MANGUERA TRASERA CENTRAL 382690 DEL 05 AL 10	482
		05-10	MANGUERA DE FRENOS	382689	DEL DER	23"		482
		97-02	PISTÓN FRENO DE DISCO	85155	DEL Y TRAS	59.5 mm 2-11/32"	CALIPER DOBLE PISTON	520
		03-14	PISTÓN FRENO DE DISCO	85471	DEL Y TRAS	59.5 mm 2-11/32"	CALIPER DOBLE PISTON	524
		13-14	PISTÓN FRENO DE DISCO	851056	DEL	60.0 mm	CALIPER DOBLE PISTON	533
		97-02	REPUESTO FRENO DE DISCO	1966	DEL Y TRAS	59.5 mm 2-11/32"	CALIPER DOBLE PISTON	538
		03-14	REPUESTO FRENO DE DISCO	20930	DEL Y TRAS	59.5 mm 2-11/32"	CALIPER DOBLE PISTON	545
		11-12	REPUESTO FRENO DE DISCO	21022	TRAS	54.0 mm 2-1/8"	CALIPER DOBLE PISTON	547
		11-12	REPUESTO FRENO DE DISCO	21023	DEL	60.0 mm	CALIPER DOBLE PISTON	547
	13-14	REPUESTO FRENO DE DISCO	108241	DEL	60.0 mm	CALIPER DOBLE PISTON	554	
	SUPER DUTY	97-02	CILINDRO MAESTRO	39876		1-5/16"	V8, 7.5 LTS	
	SUPER DUTY	03-08	CILINDRO MAESTRO	390530		1-3/8"	C/C DE VELOCIDAD	317

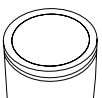

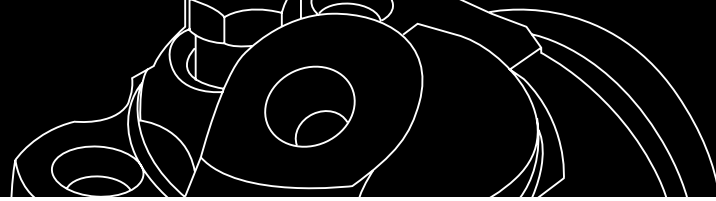

Modelo	Versión	Año	Descripción	Número Lusac	Posición	Diámetro	Notas	Foto Pág.
F-450	SUPER DUTY	03-08	CILINDRO MAESTRO	390531		1-3/8"	S/C DE VELOCIDAD	317
	SUPER DUTY	05-08	CILINDRO MAESTRO	390957		1-5/16"	S/C DE VELOCIDAD	336
	SUPER DUTY	05-08	CILINDRO MAESTRO	391043		1-5/16"	C/C DE VELOCIDAD	340
	SUPER DUTY	08-10	CILINDRO MAESTRO	391195		1-5/16"	S/C DE VELOCIDAD	348
	SUPER DUTY	08-10	CILINDRO MAESTRO	391197		1-1/2"	C/C DE VELOCIDAD	348
	SUPER DUTY	08-10	CILINDRO MAESTRO	391200		1-1/2"	S/C DE VELOCIDAD	349
F-550		99-01	CILINDRO DE CLUTCH	360108		21.0 mm 53/64"		
		99-04	CILINDRO DE CLUTCH	360109		21.0 mm		
		01-13	KIT DE PISTÓN Y REPUESTO FD	742350	DEL TRAS	59.5 mm 2-11/32"	10 V CON CALIPER DE DOBLE PISTON CUBREPOLVO DURO	
		01-06	MANGUERA DE FRENOS	381168	TRAS IZQ DER	17.37"	8V, 10V	437
		01-04	MANGUERA DE FRENOS	381262	DEL DER	26"		438
		01-04	MANGUERA DE FRENOS	381263	DEL IZQ	26"		438
		05-07	MANGUERA DE FRENOS	382688	DEL IZQ	23"		482
		05-07	MANGUERA DE FRENOS	382689	DEL DER	23"		482
		08-10	MANGUERA DE FRENOS	382709	DEL IZQ	29"		484
		08-10	MANGUERA DE FRENOS	382710	DEL DER	29"		484
		01-14	PISTÓN FRENO DE DISCO	85471	DEL Y TRAS	59.5 mm 2-11/32"	CALIPER DOBLE PISTON	524
		01-14	REPUESTO FRENO DE DISCO	20930	DEL Y TRAS	59.5 mm 2-11/32"	CALIPER DOBLE PISTON	545
	SUPER DUTY	01-07	CILINDRO MAESTRO	390530		1-3/8"	C/C DE VELOCIDAD	317
	SUPER DUTY	01-07	CILINDRO MAESTRO	390531		1-3/8"	S/C DE VELOCIDAD	317
	SUPER DUTY	05-07	CILINDRO MAESTRO	390957		1-5/16"	S/C DE VELOCIDAD	336
	SUPER DUTY	05-07	CILINDRO MAESTRO	391043		1-5/16"	C/C DE VELOCIDAD	340
	SUPER DUTY	08-10	CILINDRO MAESTRO	391195		1-5/16"	S/C DE VELOCIDAD	348
	SUPER DUTY	08-10	CILINDRO MAESTRO	391197		1-1/2"	C/C DE VELOCIDAD	348
SUPER DUTY	08-10	CILINDRO MAESTRO	391200		1-1/2"	S/C DE VELOCIDAD	349	
F-600		84-88	CILINDRO DE RUEDA	26159	DER	38.1 mm 1-1/2"	INFERIOR	
		84-88	CILINDRO DE RUEDA	26159	DER	38.1 mm 1-1/2"	SUPERIOR	
		84-88	CILINDRO DE RUEDA	26159	IZQ	38.1 mm 1-1/2"	INFERIOR	
		84-88	CILINDRO DE RUEDA	26159	IZQ	38.1 mm 1-1/2"	SUPERIOR	
		80-88	CILINDRO DE RUEDA	43375	IZQ	28.5 mm 1-1/8"	INFERIOR	
		80-88	CILINDRO DE RUEDA	43376	DER	28.5 mm 1-1/8"	INFERIOR	
		80-85	CILINDRO DE RUEDA	55890	IZQ	27.7 mm 1-3/32"		
		80-85	CILINDRO DE RUEDA	55891	DER	27.7 mm 1-3/32"		
		84-88	CILINDRO DE RUEDA	71238	DER	41.3 mm 1-5/8"	INFERIOR	
		84-88	CILINDRO DE RUEDA	71238	DER	41.3 mm 1-5/8"	SUPERIOR	
		84-88	CILINDRO DE RUEDA	71238	IZQ	41.3 mm 1-5/8"	INFERIOR	
		84-88	CILINDRO DE RUEDA	71238	IZQ	41.3 mm 1-5/8"	SUPERIOR	
		80-88	CILINDRO DE RUEDA	73500	IZQ	28.5 mm 1-1/8"	SUPERIOR	
		80-85	CILINDRO DE RUEDA	78743	DER	38.1 mm 1-1/2"	INFERIOR	
		80-85	CILINDRO DE RUEDA	78743	DER	38.1 mm 1-1/2"	SUPERIOR	
		80-85	CILINDRO DE RUEDA	78743	IZQ	38.1 mm 1-1/2"	INFERIOR	





Modelo	Versión	Año	Descripción	Número Lusac	Posición	Diámetro	Notas	Foto Pág.	
FORD									
F-600		80-85	CILINDRO DE RUEDA	78743	IZQ	38.1 mm 1-1/2"	SUPERIOR		
		80-85	CILINDRO DE RUEDA	103223	IZQ	27.7 mm 1-3/32"			
		80-85	CILINDRO DE RUEDA	103224	DER	27.7 mm 1-3/32"			
		80-85	CILINDRO MAESTRO	103254		38.1 mm 1-1/2"			
		84-88	CILINDRO MAESTRO	116702		44.4 mm 1-3/4"			
		80-85	MANGUERA DE FRENOS	1178	DEL IZQ	25 1/8"			
		80-85	MANGUERA DE FRENOS	1185M	DEL IZQ	25 1/8"			
	80-85	REP. CIL. MAESTRO Y DE CLUTCH	103255		38.1 mm 1-1/2"				
FIESTA		98-01	PISTÓN FRENO DE DISCO	85812	DEL	54.0 mm 2-1/8"		526	
		03-14	PISTÓN FRENO DE DISCO	85812	DEL	54.0 mm 2-1/8"		526	
		98-01	PISTÓN FRENO DE DISCO	85813	DEL	48.0 mm 1-57/64"		526	
		03-06	PISTÓN FRENO DE DISCO	85813	DEL	48.0 mm 1-57/64"		526	
		98-01	REPUESTO FRENO DE DISCO	1449	DEL	54.0 mm 2-1/8"		537	
		03-14	REPUESTO FRENO DE DISCO	1449	DEL	54.0 mm 2-1/8"		537	
		98-01	REPUESTO FRENO DE DISCO	2813	DEL	48.0 mm 1-57/64"		543	
		03-06	REPUESTO FRENO DE DISCO	2813	DEL	48.0 mm 1-57/64"		543	
		SEDAN FIRST, SEDAN TREND	03-10	CILINDRO DE RUEDA	3700900	DER	19.0 mm 3/4"		383
		SEDAN FIRST, SEDAN TREND	03-10	CILINDRO DE RUEDA	3700900	IZQ	19.0 mm 3/4"		383
		SEDAN FIRST, SEDAN TREND	03-10	CILINDRO DE RUEDA	3700908	DER	19.0 mm 3/4"		383
		SEDAN FIRST, SEDAN TREND	03-10	CILINDRO DE RUEDA	3700908	IZQ	19.0 mm 3/4"		383
		SEDAN FIRST, SEDAN TREND	03-10	CILINDRO MAESTRO	39009904		15/16"		360
		SEDAN FIRST, SEDAN TREND	03-10	CILINDRO MAESTRO	39009906		15/16"	1.6 LTS	360
		SEDAN FIRST, SEDAN TREND	03-06	REP. CIL. MAESTRO Y DE CLUTCH	903320		23.8 mm 15/16"		562
		SEDAN FIRST, SEDAN TREND	03-06	REP. CIL. MAESTRO Y DE CLUTCH	904081		23.8 mm 15/16"		562
		SEDAN, SEDANT TREND	11-14	CILINDRO DE RUEDA	370225	DER	3/4"		382
		SEDAN, SEDANT TREND	11-14	CILINDRO DE RUEDA	370225	IZQ	3/4"		382
		SEDAN	11-14	CILINDRO DE RUEDA	370225	TRAS IZQ	19.0 mm 3/4"		382
		SEDAN	11-14	CILINDRO DE RUEDA	370225	TRAS DER	19.0 mm 3/4"		382
			98-01	CILINDRO DE RUEDA	3700900	TRAS DER	19.0 mm 3/4"		383
			98-01	CILINDRO DE RUEDA	3700900	TRAS IZQ	19.0 mm 3/4"		383
			11-14	CILINDRO MAESTRO	391238		20.6 mm 13/16"	MANUAL	
		98-01	CILINDRO MAESTRO	39009904		15/16"		360	

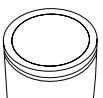



Modelo	Versión	Año	Descripción	Número Lusac	Posición	Diámetro	Notas	Foto Pág.
FIESTA		98-14	KIT DE PISTÓN Y REPUESTO FD	742387	DEL	54.0 mm 2-1/8"		
		98-01	REP. CIL. MAESTRO Y DE CLUTCH	903320		23.8 mm 15/16"		562
FIVE HUNDRED		05-07	MANGUERA DE FRENOS	382385	TRAS DER	9.38"		462
		05-07	MANGUERA DE FRENOS	382385	TRAS IZQ	9.38"		462
		05-07	MANGUERA DE FRENOS	382389	DEL DER	21.63"		462
		05-07	MANGUERA DE FRENOS	382390	DEL IZQ	21.63"		463
		05-07	CILINDRO MAESTRO	390919		1"	C/C DE TRACCIÓN	334
		05-07	CILINDRO MAESTRO	390960		1"	S/C DE TRACCIÓN	336
FOCUS		00-04	MANGUERA DE FRENOS	381369	TRAS DER	8.95"		444
		00-04	MANGUERA DE FRENOS	381369	TRAS IZQ	8.95"		444
		00-04	MANGUERA DE FRENOS	381376	DEL DER	14.1"		445
		00-04	MANGUERA DE FRENOS	381376	DEL IZQ	14.1"		445
		00-04	PISTÓN FRENO DE DISCO	85810	DEL	54.0 mm 2-1/8"		526
		00-04	REPUESTO FRENO DE DISCO	2810	DEL	54.0 mm 2-1/8"		543
		02-04	REPUESTO FRENO DE DISCO	21995	TRAS	54.0 mm 2-1/8"		552
	ELECTRIC	08-11	CILINDRO DE RUEDA	370121	TRAS IZQ DER	7/8"		377
	EUROPA	07-07	CILINDRO MAESTRO	390643		15/16"	S/ABS	321
	EUROPA	07-07	CILINDRO MAESTRO	390819		15/16"	C/ABS, S/C DE TRACCIÓN	330
	EUROPA	07-07	MANGUERA DE FRENOS	381376	DEL DER	14.1"		445
	EUROPA	07-07	MANGUERA DE FRENOS	381376	DEL IZQ	14.1"		445
	EUROPA	07-07	MANGUERA DE FRENOS	382392	TRAS DER	8.69"		463
	EUROPA	07-07	MANGUERA DE FRENOS	382393	TRAS IZQ	17.5"		463
	EUROPA	07-07	PISTÓN FRENO DE DISCO	85810	DEL	54.0 mm 2-1/8"		526
	EUROPA	07-07	REPUESTO FRENO DE DISCO	2810	DEL	54.0 mm 2-1/8"		543
	LX	05-07	CILINDRO DE RUEDA	370121	TRAS DER	7/8"		377
	LX	05-07	CILINDRO DE RUEDA	370121	TRAS IZQ	7/8"		377
	LX	05-07	CILINDRO MAESTRO	390643		15/16"	S/ABS	321
	LX	05-08	CILINDRO MAESTRO	390819		15/16"	C/ABS, S/C DE TRACCIÓN	330
	LX	07-08	MANGUERA DE FRENOS	381369	TRAS DER	8.95"		444
	LX	07-08	MANGUERA DE FRENOS	381369	TRAS IZQ	8.95"		444
	LX	05-07	MANGUERA DE FRENOS	381376	DEL DER	14.1"		445
	LX	07-07	MANGUERA DE FRENOS	381376	DEL IZQ	14.1"		445
	LX	05-07	MANGUERA DE FRENOS	381376	DEL IZQ	14.1"	DS EN EL 06-07 PUEDE LLEVAR LA MANGUERA 382533	445
	LX	05-07	MANGUERA DE FRENOS	382392	TRAS DER	8.69"		463
	LX	05-07	MANGUERA DE FRENOS	382392	TRAS IZQ	8.69"		463
	LX	05-07	MANGUERA DE FRENOS	382393	TRAS DER	17.5"		463
	LX	05-07	MANGUERA DE FRENOS	382393	TRAS IZQ	17.5"		463
	LX	08-11	MANGUERA DE FRENOS	382534	DEL DER	14.56"		470
	LX	08-11	MANGUERA DE FRENOS	382535	DEL IZQ	14.56"		470
	LX	05-06	PISTÓN FRENO DE DISCO	85810	DEL	54.0 mm 2-1/8"		526
LX	07-11	PISTÓN FRENO DE DISCO	851015	DEL	57.1 mm 2-1/4"		531	
LX	05-06	REP. CIL. MAESTRO Y DE CLUTCH	903310		23.8 mm 15/16"		562	
LX	05-06	REPUESTO FRENO DE DISCO	2810	DEL	54.0 mm 2-1/8"		543	





Modelo	Versión	Año	Descripción	Número Lusac	Posición	Diámetro	Notas	Foto Pág.
FORD								
FOCUS	LX	07-11	REPUESTO FRENO DE DISCO	21996	DEL	57.1 mm 2-1/4"		552
	SVT	02-02	CILINDRO MAESTRO	390678		15/16"	C/ABS, S/C DE TRACCIÓN CIL BOSCH	322
	SVT	02-02	MANGUERA DE FRENOS	381369	TRAS DER	8.95"		444
	SVT	02-02	MANGUERA DE FRENOS	381369	TRAS IZQ	8.95"		444
	SVT	02-02	MANGUERA DE FRENOS	381376	DEL DER	14.1"		445
	SVT	02-02	MANGUERA DE FRENOS	381376	DEL IZQ	14.1"		445
	SVT	02-02	PISTÓN FRENO DE DISCO	85810	DEL	54.0 mm 2-1/8"		526
	SVT	02-02	REP. CIL. MAESTRO Y DE CLUTCH	903310		23.8 mm 15/16"		562
	SVT	02-02	REPUESTO FRENO DE DISCO	2810	DEL	54.0 mm 2-1/8"		543
	SVT	02-02	REPUESTO FRENO DE DISCO	21995	TRAS	54.0 mm 2-1/8"		552
	ZX3	00-04	CILINDRO DE RUEDA	37660	DER	7/8"		365
	ZX3	00-04	CILINDRO DE RUEDA	37660	IZQ	7/8"		365
	ZX3	00-04	CILINDRO MAESTRO	390678		15/16"	C/ABS, S/C DE TRACCIÓN CIL BOSCH	322
	ZX3	00-04	MANGUERA DE FRENOS	381369	TRAS DER	8.95"		444
	ZX3	00-04	MANGUERA DE FRENOS	381369	TRAS IZQ	8.95"		444
	ZX3	00-04	MANGUERA DE FRENOS	381376	DEL DER	14.1"		445
	ZX3	00-04	MANGUERA DE FRENOS	381376	DEL IZQ	14.1"		445
	ZX3	00-04	PISTÓN FRENO DE DISCO	85810	DEL	54.0 mm 2-1/8"		526
	ZX3	00-04	REP. CIL. MAESTRO Y DE CLUTCH	903310		23.8 mm 15/16"		562
	ZX3	00-04	REPUESTO FRENO DE DISCO	2810	DEL	54.0 mm 2-1/8"		543
		02-04	CILINDRO DE RUEDA	37660	DER	7/8"		365
		02-04	CILINDRO DE RUEDA	37660	IZQ	7/8"		365
		00-01	CILINDRO DE RUEDA	370093	DER	13/16"		376
		00-01	CILINDRO DE RUEDA	370093	IZQ	13/16"		376
		00-04	CILINDRO MAESTRO	390643		15/16"	S/ABS	321
		00-04	CILINDRO MAESTRO	390678		15/16"	C/ABS, S/C DE TRACCIÓN CIL BOSCH	322
		00-04	CILINDRO MAESTRO	390809		15/16"	C/ABS, C/C DE TRACCIÓN	329
		00-04	CILINDRO MAESTRO	390819		15/16"	C/ABS, S/C DE TRACCIÓN	330
		09-11	CILINDRO MAESTRO	391137		23.8 mm 15/16"		
		09-10	CILINDRO MAESTRO	391379		23.8 mm 15/16"	S/ABS	357
		07-11	KIT DE PISTÓN Y REPUESTO FD	742402	DEL	57.1 mm 2-1/4"		
		05-05	MANGUERA DE FRENOS	382391	DEL IZQ DER	15.63"		463
	06-07	MANGUERA DE FRENOS	382533	DEL IZQ DER	16.12"		470	
	00-04	REP. CIL. MAESTRO Y DE CLUTCH	903310		23.8 mm 15/16"		562	
FREESTAR		04-07	MANGUERA DE FRENOS	382664	DEL IZQ	18.75"		480
		04-07	MANGUERA DE FRENOS	382665	DEL DER	15.75"		480
		04-07	MANGUERA DE FRENOS	382665	TRAS DER	15.75"		480
		04-07	PISTÓN FRENO DE DISCO	85242	DEL	50.8 mm 2"		522
		04-07	REPUESTO FRENO DE DISCO	1967	TRAS	45.0 mm		538

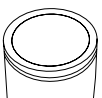



Modelo	Versión	Año	Descripción	Número Lusac	Posición	Diámetro	Notas	Foto Pág.
FREESTAR		04-07	REPUESTO FRENO DE DISCO	2242	DEL	50.8 mm 2"		
		04-05	CILINDRO MAESTRO	390810		1-1/16"		329
		06-07	CILINDRO MAESTRO	390919		1"	C/C DE TRACCIÓN	334
		06-07	CILINDRO MAESTRO	390960		1"	S/C DE TRACCIÓN	336
		06-07	CILINDRO MAESTRO	391255		26.9 mm 1-1/16"	S/C DE TRACCIÓN	352
FUSION		06-07	MANGUERA DE FRENOS	382575	DEL IZQ	25.62"		473
		06-07	MANGUERA DE FRENOS	382576	TRAS DER	11.62"		474
		06-07	MANGUERA DE FRENOS	382576	TRAS IZQ	11.62"		474
		06-07	REPUESTO FRENO DE DISCO	2472	DEL	57.1 mm 2-1/4"		541
		10-12	REPUESTO FRENO DE DISCO	2472	DEL	57.1 mm 2-1/4"		541
		06-07	REPUESTO FRENO DE DISCO	21005	TRAS	34.1 mm 1-11/32"		546
		10-12	REPUESTO FRENO DE DISCO	21005	TRAS	34.1 mm 1-11/32"		546
	SE	08-09	CILINDRO MAESTRO	391069		13/16"	C/ABS	341
	SE	08-09	CILINDRO MAESTRO	391129		13/16"	S/ABS	343
	SE	08-09	MANGUERA DE FRENOS	382575	DEL IZQ	25.62"		473
	SE	08-09	MANGUERA DE FRENOS	382576	TRAS DER	11.62"		474
	SE	08-09	MANGUERA DE FRENOS	382576	TRAS IZQ	11.62"		474
	SE	08-09	PISTÓN FRENO DE DISCO	851060	DEL	57.1 mm 2-1/4"		533
	SE	08-09	REPUESTO FRENO DE DISCO	2472	DEL	57.1 mm 2-1/4"		541
	SE	08-09	REPUESTO FRENO DE DISCO	21005	TRAS	34.1 mm 1-11/32"		546
	SE, PREMIUM	06-07	CILINDRO MAESTRO	391069		13/16"	C/ABS	341
	SE, PREMIUM	06-07	CILINDRO MAESTRO	391129		13/16"	S/ABS	343
	06-12	KIT DE PISTÓN Y REPUESTO FD	742410	DEL	57.1 mm 2-1/4"			
GHIA		91-94	MANGUERA DE FRENOS	4062	DEL DER	16 1/2"		386
		91-94	MANGUERA DE FRENOS	4063	DEL IZQ	16 5/8"		386
		91-94	MANGUERA DE FRENOS	38378	TRAS DER	10.75"		391
		91-94	MANGUERA DE FRENOS	38378	TRAS IZQ	10.75"		391
		91-94	PISTÓN FRENO DE DISCO	108159	DEL	60.0 mm		528
		91-94	REPUESTO FRENO DE DISCO	108241	DEL	60.0 mm		554
		91-94	CILINDRO DE RUEDA	108106	DER	22.2 mm 7/8"		372
		91-94	CILINDRO DE RUEDA	108107	IZQ	22.2 mm 7/8"		372
		91-94	CILINDRO MAESTRO	108151		20.0 mm		297
		94-94	CILINDRO MAESTRO	390217		23.8 mm 15/16"		304
		91-94	KIT DE PISTÓN Y REPUESTO FD	742324	DEL	60.0 mm		
GRAND MARQUIS		95-97	MANGUERA DE FRENOS	5021	TRAS CTR	14 7/8"		386
		92-94	MANGUERA DE FRENOS	380041	DEL IZQ	11.75"		404
		92-94	MANGUERA DE FRENOS	380042	DEL DER	11.25"		404
		92-97	MANGUERA DE FRENOS	380043	TRAS DER	12.25"		404
		92-97	MANGUERA DE FRENOS	380044	TRAS IZQ	12"		404
		95-97	MANGUERA DE FRENOS	380296	DEL DER	11"		411
		95-97	MANGUERA DE FRENOS	380297	DEL IZQ	11"		411
	98-02	MANGUERA DE FRENOS	381071	TRAS IZQ	18"		433	





Modelo	Versión	Año	Descripción	Número Lusac	Posición	Diámetro	Notas	Foto Pág.
FORD								
GRAND MARQUIS		98-99	MANGUERA DE FRENOS	381072	TRAS CTR	18"		433
		98-99	MANGUERA DE FRENOS	381073	TRAS DER	20.5"		433
		98-02	MANGUERA DE FRENOS	381133	DEL IZQ	11.15"		435
		98-02	MANGUERA DE FRENOS	381141	DEL DER	11.15"		435
		00-02	MANGUERA DE FRENOS	381141	DEL IZQ	11.15"		435
		01-02	MANGUERA DE FRENOS	381144	DEL DER	11.16"		436
		00-04	MANGUERA DE FRENOS	381285	TRAS DER	24.9"		440
		03-04	MANGUERA DE FRENOS	381285	TRAS IZQ	24.9"		440
		03-04	MANGUERA DE FRENOS	382468	DEL DER	20.5"		466
		03-04	MANGUERA DE FRENOS	382482	TRAS DER	20.25"		467
		03-04	MANGUERA DE FRENOS	382483	TRAS IZQ	20.25"		467
		92-04	PISTÓN FRENO DE DISCO	85424	TRAS	47.6 mm 1-7/8"		524
		95-97	PISTÓN FRENO DE DISCO	85438	DEL	65.9 mm 2-19/32"		524
		98-04	PISTÓN FRENO DE DISCO	85477	DEL	48.0 mm 1-57/64"	CALIPER DOBLE PISTON	525
		92-94	PISTÓN FRENO DE DISCO	98899	DEL	73.0 mm 2-7/8"		528
		95-97	REPUESTO FRENO DE DISCO	1837	DEL	65.9 mm 2-19/32"		538
		98-02	REPUESTO FRENO DE DISCO	2477	TRAS	48.0 mm 1-57/64"		541
		92-04	REPUESTO FRENO DE DISCO	2769	TRAS	47.6 mm 1-7/8"		543
		98-04	REPUESTO FRENO DE DISCO	2817	DEL	48.0 mm 1-57/64"	CALIPER DOBLE PISTON	544
		92-94	REPUESTO FRENO DE DISCO	98948	DEL	73.0 mm 2-7/8"		553
		92-94	CILINDRO MAESTRO	390024		1"	C/ABS	299
		95-95	CILINDRO MAESTRO	390245		1"	C/ABS	305
		95-96	CILINDRO MAESTRO	390256		1"		305
		96-96	CILINDRO MAESTRO	390299		1"	C/ABS	307
		97-97	CILINDRO MAESTRO	390430		1"	C/ABS	313
		97-00	CILINDRO MAESTRO	390445		1"	S/C DE TRACCIÓN	314
		98-00	CILINDRO MAESTRO	390569		1"	C/C DE TRACCIÓN	319
	01-04	CILINDRO MAESTRO	390693		1"	S/C DE TRACCIÓN	323	
	01-04	CILINDRO MAESTRO	390702		1"	C/C DE TRACCIÓN	323	
	95-97	KIT DE PISTÓN Y REPUESTO FD	742340	DEL	65.9 mm 2-19/32"			
	98-04	KIT DE PISTÓN Y REPUESTO FD	742376	DEL	48.0 mm 1-57/64"			
IKON	FIESTA	01-07	CILINDRO DE RUEDA	3700900	DER	19.0 mm 3/4"		383
	FIESTA	01-07	CILINDRO DE RUEDA	3700900	IZQ	19.0 mm 3/4"		383
	FIESTA	01-10	CILINDRO MAESTRO	39009904		15/16"		360
	FIESTA	01-07	PISTÓN FRENO DE DISCO	85812	DEL	54.0 mm 2-1/8"		526
	FIESTA	01-01	PISTÓN FRENO DE DISCO	85813	DEL	48.0 mm 1-57/64"		526
	FIESTA	01-10	REP. CIL. MAESTRO Y DE CLUTCH	903320		23.8 mm 15/16"		562
	FIESTA	01-07	REPUESTO FRENO DE DISCO	1449	DEL	54.0 mm 2-1/8"		537
	FIESTA	01-01	REPUESTO FRENO DE DISCO	2813	DEL	48.0 mm 1-57/64"		543
		01-07	KIT DE PISTÓN Y REPUESTO FD	742387	DEL	54.0 mm 2-1/8"		
KA		01-08	PISTÓN FRENO DE DISCO	85812	DEL	54.0 mm 2-1/8"		526

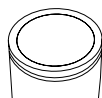



Modelo	Versión	Año	Descripción	Número Lusac	Posición	Diámetro	Notas	Foto Pág.
KA		01-08	REPUESTO FRENO DE DISCO	1449	DEL	54.0 mm 2-1/8"		537
	INCLUYE SPORT	01-08	CILINDRO DE RUEDA	3700900	DER	19.0 mm 3/4"		383
	INCLUYE SPORT	01-08	CILINDRO DE RUEDA	3700900	IZQ	19.0 mm 3/4"		383
	INCLUYE SPORT	01-08	CILINDRO MAESTRO	MIS55214		22.2 mm 7/8"	CIL RAYBES-TOS - VARGA	363
	INCLUYE SPORT	01-08	REP. CIL. MAESTRO Y DE CLUTCH	903330		22.2 mm 7/8"		562
		01-08	KIT DE PISTÓN Y REPUESTO FD	742387	DEL	54.0 mm 2-1/8"		
LOBO	150	97-99	CILINDRO DE RUEDA	78974	IZQ	25.4 mm 1"		370
	150	04-04	CILINDRO DE RUEDA	78974	IZQ	25.4 mm 1"		370
	150	97-99	CILINDRO DE RUEDA	78975	DER	25.4 mm 1"		371
	150	04-04	CILINDRO DE RUEDA	78975	DER	25.4 mm 1"		371
	150	00-02	CILINDRO DE RUEDA	3700901	IZQ	22.2 mm 7/8"		383
	150	00-02	CILINDRO DE RUEDA	3700902	DER	22.2 mm 7/8"		383
	150	97-99	CILINDRO MAESTRO	120369		26.9 mm 1-1/16"	S/C DE VELOCIDAD 4X2	298
	150	97-99	CILINDRO MAESTRO	390183		1-1/8"	C/C DE VELOCIDAD	302
	150	00-04	CILINDRO MAESTRO	390336		1-1/4"	S/C DE VELOCIDAD	309
	150	00-04	CILINDRO MAESTRO	390337		1-1/4"	C/C DE VELOCIDAD	309
	150	00-00	CILINDRO MAESTRO	390339		1-1/4"	S/C DE VELOCIDAD	310
	150	01-02	CILINDRO MAESTRO	390802		1-1/4"	S/C CRUCERO	328
	150	04-12	CILINDRO MAESTRO	390811		1-1/8"		329
	150	97-99	MANGUERA DE FRENOS	380553	DEL IZQ	21"		425
	150	04-04	MANGUERA DE FRENOS	380553	DEL IZQ	21"		425
	150	97-99	MANGUERA DE FRENOS	380554	DEL DER	21"		425
	150	04-04	MANGUERA DE FRENOS	380554	DEL DER	21"		425
	150	00-04	MANGUERA DE FRENOS	380555	DEL IZQ	17.75"		425
	150	97-98	MANGUERA DE FRENOS	380555	DEL IZQ	17.75"		425
	150	97-98	MANGUERA DE FRENOS	380556	DEL DER	43.25"		425
	150	00-04	MANGUERA DE FRENOS	380556	DEL DER	43.25"		425
	150	97-99	MANGUERA DE FRENOS	380935	TRAS IZQ	21.78"		429
	150	04-04	MANGUERA DE FRENOS	380935	TRAS IZQ	21.78"		429
	150	01-04	MANGUERA DE FRENOS	380936	TRAS DER	24.28"		429
	150	97-98	MANGUERA DE FRENOS	380936	TRAS IZQ	24.28"		429
	150	00-04	MANGUERA DE FRENOS	380936	TRAS IZQ	24.28"		429
	150	01-04	MANGUERA DE FRENOS	381338	DEL IZQ	19.5"		442
	150	04-10	MANGUERA DE FRENOS	382727	TRAS IZQ	11.62"		485
	150	97-04	PISTÓN FRENO DE DISCO	85013	DEL	50.8 mm 2"	CALIPER DOBLE PISTON	518
	150	04-04	PISTÓN FRENO DE DISCO	85477	DEL	48.0 mm 1-57/64"	CALIPER DOBLE PISTON	525
	150	97-04	PISTÓN FRENO DE DISCO	85827	TRAS	50.8 mm 2"		527
	150	05-10	PISTÓN FRENO DE DISCO	851024	DEL	54.0 mm 2-1/8"	CALIPER DOBLE PISTON	531
	150	07-10	PISTÓN FRENO DE DISCO	851025	TRAS	51.0 mm		531
	150	00-04	REP. CIL. MAESTRO Y DE CLUTCH	90337		31.7 mm 1-1/4"		559
	150	97-99	REPUESTO CILINDRO DE RUEDA	114084		26.9 mm 1-1/16"		561
	150	97-04	REPUESTO FRENO DE DISCO	2817	DEL	48.0 mm 1-57/64"		544
150	97-04	REPUESTO FRENO DE DISCO	2827	TRAS	50.8 mm 2"		544	





Modelo	Versión	Año	Descripción	Número Lusac	Posición	Diámetro	Notas	Foto Pág.
FORD								
LOBO	150	05-10	REPUESTO FRENO DE DISCO	21024	DEL	54.0 mm 2-1/8"		547
	150	07-10	REPUESTO FRENO DE DISCO	21025	TRAS	51.0 mm		547
		06-10	KIT DE PISTÓN Y REPUESTO FD	742305	DEL	54.0 mm 2-1/8"	CON CALIPER DE DOBLE PISTON	
		06-10	KIT DE PISTÓN Y REPUESTO FD	742306	TRAS	51.0 mm		
		99-04	KIT DE PISTÓN Y REPUESTO FD	742368	DEL	50.8 mm 2"	S/C DE VELOCIDAD	
		97-04	KIT DE PISTÓN Y REPUESTO FD	742379	TRAS	50.8 mm 2"		
MAVERICK		74-77	KIT DE PISTÓN Y REPUESTO FD	742334	DEL	65.9 mm 2-19/32"		
MONDEO	CORE	01-07	PISTÓN FRENO DE DISCO	85393	DEL	57.1 mm 2-1/4"		524
	CORE	01-07	REPUESTO FRENO DE DISCO	2820	DEL	57.1 mm 2-1/4"		544
	GHIA	02-07	PISTÓN FRENO DE DISCO	85393	DEL	57.1 mm 2-1/4"		524
	GHIA	02-07	REPUESTO FRENO DE DISCO	2820	DEL	57.1 mm 2-1/4"		544
	SPORT XLS	03-04	CILINDRO DE RUEDA	37708	IZQ	7/8"		366
	SPORT XLS	03-04	CILINDRO DE RUEDA	37709	DER	7/8"		366
	SPORT XLS	03-04	CILINDRO MAESTRO	390654		1"	C/ABS	321
	SPORT XLS	03-04	CILINDRO MAESTRO	390655		1"	S/ABS	321
	SPORT XLS	03-04	MANGUERA DE FRENOS	36824	DEL DER	8.88"		387
	SPORT XLS	03-04	MANGUERA DE FRENOS	36824	DEL IZQ	8.88"		387
	TREND	01-07	PISTÓN FRENO DE DISCO	85393	DEL	57.1 mm 2-1/4"		524
	TREND	01-07	REPUESTO FRENO DE DISCO	2820	DEL	57.1 mm 2-1/4"		544
		01-07	KIT DE PISTÓN Y REPUESTO FD	742419	DEL	57.1 mm 2-1/4"		
MONTEGO		05-07	MANGUERA DE FRENOS	382385	TRAS DER	9.38"		462
		05-07	MANGUERA DE FRENOS	382385	TRAS IZQ	9.38"		462
		05-07	MANGUERA DE FRENOS	382389	DEL DER	21.63"		462
		05-07	MANGUERA DE FRENOS	382390	DEL IZQ	21.63"		463
		05-07	CILINDRO MAESTRO	390919		1"	C/C DE TRACCIÓN	334
		05-07	CILINDRO MAESTRO	390960		1"	S/C DE TRACCIÓN	336
MUSTANG		05-14	MANGUERA DE FRENOS	382329	DEL IZQ	21.5"		457
		05-14	MANGUERA DE FRENOS	382330	DEL DER	21"		457
		05-14	MANGUERA DE FRENOS	382333	TRAS DER	12.38"		457
		05-14	MANGUERA DE FRENOS	382334	TRAS IZQ	12.38"		457
	COBRA	97-97	CILINDRO MAESTRO	390309		1"	V8, 4.6 LTS	308
	COBRA	97-97	MANGUERA DE FRENOS	380263	DEL	15"		410
	COBRA	97-97	MANGUERA DE FRENOS	380521	DEL	14.25"		424
	COBRA	97-97	REPUESTO FRENO DE DISCO	2823	TRAS	38.1 mm 1-1/2"		544
	CONVERTIBLE	06-14	MANGUERA DE FRENOS	382329	DEL IZQ	21.5"		457
	CONVERTIBLE	06-14	MANGUERA DE FRENOS	382330	DEL DER	21"		457
	CONVERTIBLE	06-14	MANGUERA DE FRENOS	382333	TRAS DER	12.38"		457
	CONVERTIBLE	06-14	MANGUERA DE FRENOS	382334	TRAS IZQ	12.38"		457
CONVERTIBLE	06-10	MANGUERA DE FRENOS	382335	TRAS DER	12.38"		457	

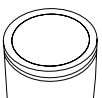

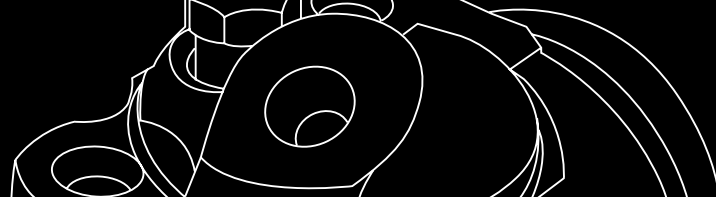

Modelo	Versión	Año	Descripción	Número Lusac	Posición	Diámetro	Notas	Foto Pág.
MUSTANG	CONVERTIBLE	06-10	MANGUERA DE FRENOS	382336	TRAS IZQ	12.38"		457
	GT	94-95	CILINDRO MAESTRO	390185		1-1/16"		303
	GT	96-97	CILINDRO MAESTRO	390308		1"		308
	GT	99-04	CILINDRO MAESTRO	390525		1"	S/C DE TRACCIÓN V6	316
	GT	98-04	CILINDRO MAESTRO	390527		1-1/16"	S/C DE TRACCIÓN V8	316
	GT	99-04	CILINDRO MAESTRO	390528		1-1/16"	C/C DE TRACCIÓN	317
	GT	94-95	MANGUERA DE FRENOS	38372	TRAS INT	9.63"		391
	GT	94-98	MANGUERA DE FRENOS	380263	DEL DER	15"		410
	GT	94-98	MANGUERA DE FRENOS	380371	TRAS DER	11"		417
	GT	94-98	MANGUERA DE FRENOS	380372	TRAS IZQ	10.25"		417
	GT	94-98	MANGUERA DE FRENOS	380521	DEL IZQ	14.25"		424
	GT	99-04	MANGUERA DE FRENOS	381283	TRAS IZQ	13.5"		440
	GT	99-04	MANGUERA DE FRENOS	381284	TRAS DER	13.5"		440
	GT	99-04	MANGUERA DE FRENOS	381286	DEL DER	24.9"		440
	GT	99-04	MANGUERA DE FRENOS	381287	DEL IZQ	24.37"		440
	GT	99-04	MANGUERA DE FRENOS	381308	TRAS DER	21.42"		441
	GT	99-04	MANGUERA DE FRENOS	381390	TRAS IZQ	13.9"		446
	GT	98-04	PISTÓN FRENO DE DISCO	85119	DEL	45.0 mm	CALIPER DOBLE PISTON	519
	GT	94-95	REP. CIL. MAESTRO Y DE CLUTCH	90185		26.9 mm 1-1/16"		558
	GT	98-98	REPUESTO FRENO DE DISCO	1837	DEL	65.9 mm 2-19/32"		538
	GT	98-04	REPUESTO FRENO DE DISCO	2275	DEL	45.0 mm	CALIPER DOBLE PISTON	541
	GT	94-04	REPUESTO FRENO DE DISCO	2823	TRAS	38.1 mm 1-1/2"		544
	GT	94-97	REPUESTO FRENO DE DISCO	04-112486	DEL	65.9 mm 2-19/32"		554
		94-95	CILINDRO MAESTRO	390217		23.8 mm 15/16"	CHOCOLATE	304
		74-78	KIT DE PISTÓN Y REPUESTO FD	742334	DEL	65.9 mm 2-19/32"		
		98-98	KIT DE PISTÓN Y REPUESTO FD	742340	DEL	65.9 mm 2-19/32"		
		98-04	KIT DE PISTÓN Y REPUESTO FD	742370	DEL	45.0 mm	CON CALIPER DE DOBLE PISTON	
		05-08	MANGUERA DE FRENOS	382331	DEL IZQ	21"	S/ABS	457
		05-08	MANGUERA DE FRENOS	382332	DEL DER	21.5"	S/ABS	457
	MYSTIQUE	95-00	MANGUERA DE FRENOS	380421	DEL DER	15.25"		420
		95-00	MANGUERA DE FRENOS	380421	DEL IZQ	15.25"		420
		95-96	MANGUERA DE FRENOS	380422	TRAS DER	12"		420
		95-96	MANGUERA DE FRENOS	380422	TRAS IZQ	12"		420
95-96		MANGUERA DE FRENOS	380423	TRAS DER	22.25"		420	
95-96		MANGUERA DE FRENOS	380423	TRAS IZQ	22.25"		420	
97-00		MANGUERA DE FRENOS	380992	TRAS DER	12.28"		430	
97-00		MANGUERA DE FRENOS	380992	TRAS IZQ	12.28"		430	
97-00		MANGUERA DE FRENOS	380993	TRAS DER	22.68"		431	
97-00		MANGUERA DE FRENOS	380993	TRAS IZQ	22.68"		431	
95-00		PISTÓN FRENO DE DISCO	85800	DEL	60.0 mm		526	
95-00		REPUESTO FRENO DE DISCO	2844	DEL	60.0 mm		544	
95-00		CILINDRO DE RUEDA	37997	DER	7/8"		370	
95-00		CILINDRO DE RUEDA	37997	IZQ	7/8"		370	
95-96		CILINDRO MAESTRO	390226		1"	S/ABS	304	





Modelo	Versión	Año	Descripción	Número Lusac	Posición	Diámetro	Notas	Foto Pág.	
FORD									
P-350	MYSTIQUE	97-00	CILINDRO MAESTRO	390463		1"	S/ABS	315	
		77-78	KIT DE PISTÓN Y REPUESTO FD	742335	DEL	73.0 mm 2-7/8"	CALIPER SENCILLO		
		94-97	KIT DE PISTÓN Y REPUESTO FD	742338	DEL	55.9 mm 2-13/64"	CON CALIPER DE DOBLE PISTON		
		76-91	KIT DE PISTÓN Y REPUESTO FD	742341	DEL	55.6 mm 2-3/16"			
		89-94	KIT DE PISTÓN Y REPUESTO FD	742342	DEL	55.6 mm 2-3/16"			
		94-95	KIT DE PISTÓN Y REPUESTO FD	742342	DEL	55.6 mm 2-3/16"			
		89-95	KIT DE PISTÓN Y REPUESTO FD	742343	DEL	55.6 mm 2-3/16"			
		MICROBUS	97-97	CILINDRO DE RUEDA	37250	IZQ	30.1 mm 1-3/16"		364
		MICROBUS	97-97	CILINDRO DE RUEDA	37251	DER	30.1 mm 1-3/16"		365
		MICROBUS	89-96	CILINDRO DE RUEDA	113757	DER	30.1 mm 1-3/16"		373
		MICROBUS	89-96	CILINDRO DE RUEDA	113758	IZQ	30.1 mm 1-3/16"		373
		MICROBUS	89-91	CILINDRO MAESTRO	39635		1-1/8"	MÁS DE 4310 KG.	294
		MICROBUS	94-96	CILINDRO MAESTRO	39635		1-1/8"	S/C DE VELOCIDAD, RODADA SENCILLA	294
		MICROBUS	93-93	CILINDRO MAESTRO	114079		28.5 mm 1-1/8"		298
		MICROBUS	89-91	CILINDRO MAESTRO	114079		28.5 mm 1-1/8"	RODADA SENCILLA	298
		MICROBUS	92-92	CILINDRO MAESTRO	390117		1-1/8"		
		MICROBUS	94-96	CILINDRO MAESTRO	390184		1-1/8"	C/C DE VELOCIDAD, DOBLE RODADA	302
		MICROBUS	97-97	CILINDRO MAESTRO	390337		1-1/4"	C/C DE VELOCIDAD	309
		MICROBUS	97-97	CILINDRO MAESTRO	390339		1-1/4"	S/C DE VELOCIDAD	310
		MICROBUS	89-91	MANGUERA DE FRENOS	38106	DEL IZQ	17.88"		
		MICROBUS	92-93	MANGUERA DE FRENOS	380077	DEL IZQ	23"		
		MICROBUS	92-93	MANGUERA DE FRENOS	380195	DEL DER	24.5"		
		MICROBUS	97-97	MANGUERA DE FRENOS	380196	TRAS IZQ	18"		408
		MICROBUS	94-95	MANGUERA DE FRENOS	380322	DEL DER	23.75"		
		MICROBUS	94-97	MANGUERA DE FRENOS	380383	DEL DER	16.75"		418
		MICROBUS	94-97	MANGUERA DE FRENOS	380384	DEL IZQ	20"		418
		MICROBUS	92-96	MANGUERA DE FRENOS	380385	TRAS IZQ	18"		418
		MICROBUS	89-95	PISTÓN FRENO DE DISCO	99980	DEL	55.6 mm 2-3/16"		528
		MICROBUS	94-97	PISTÓN FRENO DE DISCO	850300	DEL	55.9 mm 2-13/64"		529
		MICROBUS	97-97	REP. CIL. MAESTRO Y DE CLUTCH	90337		31.7 mm 1-1/4"		559
		MICROBUS	89-96	REP. CIL. MAESTRO Y DE CLUTCH	114085		28.5 mm 1-1/8"		561
		MICROBUS	89-95	REPUESTO FRENO DE DISCO	2730	DEL	55.6 mm 2-3/16"		542
		MICROBUS	94-97	REPUESTO FRENO DE DISCO	2885	DEL	55.9 mm 2-13/64"	CALIPER DOBLE PISTON	545
	MICROBUS	89-91	REPUESTO FRENO DE DISCO	88562D	DEL	55.6 mm 2-3/16"		555	
RANGER		96-06	MANGUERA DE FRENOS	38813	TRAS IZQ	19.9"		397	
		08-09	MANGUERA DE FRENOS	38813	TRAS IZQ	19.9"		397	
		98-11	MANGUERA DE FRENOS	380357	DEL DER	13.25"		416	
		98-00	MANGUERA DE FRENOS	380358	DEL IZQ	13.25"		416	
		02-11	MANGUERA DE FRENOS	380358	DEL IZQ	13.25"		416	
		96-97	MANGUERA DE FRENOS	380392	DEL IZQ	20.25"		418	
		96-97	MANGUERA DE FRENOS	380411	DEL DER	16.5"		419	
		98-05	MANGUERA DE FRENOS	380931	DEL IZQ	9.82"		429	
		01-03	MANGUERA DE FRENOS	380932	DEL IZQ	18.75"		429	

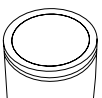

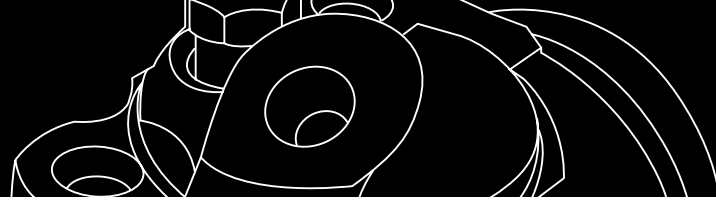

Modelo	Versión	Año	Descripción	Número Lusac	Posición	Diámetro	Notas	Foto Pág.
RANGER		07-07	MANGUERA DE FRENOS	380935	TRAS IZQ	21.78"		429
		98-00	MANGUERA DE FRENOS	380953	TRAS DER	16.13"		430
		98-05	MANGUERA DE FRENOS	380953	TRAS IZQ	16.13"		430
		98-11	MANGUERA DE FRENOS	381134	DEL IZQ	16.35"		435
		98-11	MANGUERA DE FRENOS	381135	DEL DER	16.35"		435
		98-00	MANGUERA DE FRENOS	381312	TRAS DER	16.73"		442
		98-00	MANGUERA DE FRENOS	381332	DEL DER	25.75"		442
		96-11	PISTÓN FRENO DE DISCO	85857	DEL	46.0 mm 1-13/16"	CALIPER DOBLE PISTON	527
		04-07	PISTÓN FRENO DE DISCO	850700	DEL	48.0 mm 1-57/64"	CALIPER DOBLE PISTON	529
		04-07	REPUESTO FRENO DE DISCO	2070	DEL	48.0 mm 1-57/64"	CALIPER DOBLE PISTON	539
		96-11	REPUESTO FRENO DE DISCO	2857	DEL	46.0 mm 1-13/16"	CALIPER DOBLE PISTON	544
		90-91	CILINDRO DE CLUTCH	39904		19.0 mm 3/4"	NACIONAL	
		88-91	CILINDRO DE CLUTCH	350041		19.0 mm 3/4"	CHOCOLATE	
		93-94	CILINDRO DE CLUTCH	350055		15.8 mm 5/8"	CHOCOLATE	
		93-04	CILINDRO DE CLUTCH	360016		N/R	CHOCOLATE	
		01-03	CILINDRO DE RUEDA	34876	DER	13/16"		364
		01-03	CILINDRO DE RUEDA	34876	IZQ	13/16"		364
		96-00	CILINDRO DE RUEDA	37574	DER	3/4"		365
		96-00	CILINDRO DE RUEDA	37574	IZQ	3/4"		365
		04-09	CILINDRO DE RUEDA	101604	DER	19.0 mm 3/4"		372
		04-09	CILINDRO DE RUEDA	101604	IZQ	19.0 mm 3/4"		372
		96-97	CILINDRO DE RUEDA	370031	DER	3/4"		374
		96-97	CILINDRO DE RUEDA	370031	IZQ	3/4"		374
		98-09	CILINDRO DE RUEDA	370061	DER	13/16"		375
		04-05	CILINDRO DE RUEDA	370061	DER	13/16"		375
		98-09	CILINDRO DE RUEDA	370061	IZQ	13/16"		375
		04-05	CILINDRO DE RUEDA	370061	IZQ	13/16"	TAMBIÉN PUEDE LLEVAR EL CILINDRO 370185 DEL 01 AL 06 DE 3/4"	375
		01-06	CILINDRO DE RUEDA	370185	TRAS IZQ	19.0 mm 3/4"		380
		01-06	CILINDRO DE RUEDA	370185	TRAS DER	19.0 mm 3/4"		380
		01-07	CILINDRO DE RUEDA	37009018	TRAS DER	20.6 mm 13/16"	FABRICADA EN ARGENTINA	
		01-07	CILINDRO DE RUEDA	37009019	TRAS IZQ	20.6 mm 13/16"	FABRICADA EN ARGENTINA	
		96-97	CILINDRO MAESTRO	390268		1-1/16"	C/ABS EN RUEDAS TRASERAS	306
		96-97	CILINDRO MAESTRO	390269		1-1/16"		306
		01-06	CILINDRO MAESTRO	390398		1-1/16"	C/C DE VELOCIDAD	312
		02-05	CILINDRO MAESTRO	390399		1-1/16"	S/C DE VELOCIDAD	312
		98-00	CILINDRO MAESTRO	390399		1-1/16"	S/C DE VELOCIDAD, SUSP. DE RESORTE	312
		98-00	CILINDRO MAESTRO	390400		1-1/16"		312
		01-01	CILINDRO MAESTRO	390696		1-1/16"	S/C DE VELOCIDAD	323
		07-09	CILINDRO MAESTRO	391139		27.0 mm		
		10-11	CILINDRO MAESTRO	391256		27.0 mm		
		96-11	KIT DE PISTÓN Y REPUESTO FD	742380	DEL	46.0 mm 1-13/16"	CON CALIPER DE DOBLE PISTON	
		04-07	KIT DE PISTÓN Y REPUESTO FD	742392	DEL	48.0 mm 1-57/64"	CON CALIPER DE DOBLE PISTON	
	95-97	MANGUERA DE FRENOS	380389	DEL DER	22.75"	4X4 NACIONAL	418	
	97-97	MANGUERA DE FRENOS	380938	DEL IZQ	14.62"		429	
	01-06	REP. CIL. MAESTRO Y DE CLUTCH	90398		26.9 mm 1-1/16"		559	





Modelo	Versión	Año	Descripción	Número Lusac	Posición	Diámetro	Notas	Foto Pág.
FORD								
TAURUS		88-91	MANGUERA DE FRENOS	38382	DEL IZQ	16.69"		391
		88-91	MANGUERA DE FRENOS	38666	TRAS IZQ	12.75"		396
		88-91	MANGUERA DE FRENOS	38669	TRAS DER	11.5"		396
		88-91	MANGUERA DE FRENOS	38681	DEL DER	15.75"		396
		90-91	MANGUERA DE FRENOS	38681	TRAS DER	15.75"		396
		88-91	PISTÓN FRENO DE DISCO	115614	DEL	65.9 mm 2-19/32"		529
		90-91	REPUESTO FRENO DE DISCO	1967	TRAS	45.0 mm		538
		88-91	REPUESTO FRENO DE DISCO	04-112486	DEL	65.9 mm 2-19/32"		554
		88-91	CILINDRO DE RUEDA	112365	DER	25.4 mm 1"		373
		88-91	CILINDRO DE RUEDA	112365	IZQ	25.4 mm 1"		373
		90-91	CILINDRO MAESTRO	39772		15/16"		295
		88-89	CILINDRO MAESTRO	112591		22.2 mm 7/8"	VAGONETA	298
		90-91	CILINDRO MAESTRO	120794		23.8 mm 15/16"		298
		03-06	CILINDRO MAESTRO	390812		1"		329
		88-91	KIT DE PISTÓN Y REPUESTO FD	742383	DEL	65.9 mm 2-19/32"		
		90-91	REP. CIL. MAESTRO Y DE CLUTCH	120795		23.8 mm 15/16"		562
	90-91	REP. CIL. MAESTRO Y DE CLUTCH	120797		25.4 mm 1"		562	
THUNDERBIRD		87-88	MANGUERA DE FRENOS	38384	DEL DER	16.5"		
		87-89	MANGUERA DE FRENOS	38506	TRAS IZQ	10.38"		392
		90-92	MANGUERA DE FRENOS	38609	TRAS DER	19.75"		393
		90-92	MANGUERA DE FRENOS	38610	TRAS IZQ	19.75"		393
		90-92	MANGUERA DE FRENOS	38668	DEL DER	20"		396
		90-92	MANGUERA DE FRENOS	38997	DEL IZQ	14"		403
		93-96	MANGUERA DE FRENOS	380193	TRAS DER	20"		408
		03-04	MANGUERA DE FRENOS	380193	TRAS DER	20"		408
		93-96	MANGUERA DE FRENOS	380194	TRAS IZQ	25.25"		408
		03-04	MANGUERA DE FRENOS	380194	TRAS IZQ	25.25"		408
		93-96	MANGUERA DE FRENOS	380214	TRAS DER	20"		408
		93-96	MANGUERA DE FRENOS	380215	TRAS IZQ	17.88"		408
		93-96	MANGUERA DE FRENOS	380373	DEL DER	16"		417
		93-96	MANGUERA DE FRENOS	380374	DEL IZQ	16"		417
		90-92	MANGUERA DE FRENOS	380374	TRAS IZQ	16"		417
		85-89	MANGUERA DE FRENOS	5022M	TRAS IZQ	13"		516
		89-92	PISTÓN FRENO DE DISCO	85171	DEL	65.9 mm 2-19/32"		521
		85-88	PISTÓN FRENO DE DISCO	99080	DEL	60.0 mm		528
		93-96	PISTÓN FRENO DE DISCO	99080	DEL	60.0 mm		528
		90-96	REPUESTO FRENO DE DISCO	1967	TRAS	45.0 mm		538
		03-04	REPUESTO FRENO DE DISCO	1967	TRAS	45.0 mm		538
		03-04	REPUESTO FRENO DE DISCO	2225	DEL	38.1 mm 1-1/2"		540
		85-88	REPUESTO FRENO DE DISCO	99079	DEL	60.0 mm		553
	93-96	REPUESTO FRENO DE DISCO	99079	DEL	60.0 mm		553	
	89-92	REPUESTO FRENO DE DISCO	04-112486	DEL	65.9 mm 2-19/32"		554	
	85-88	CILINDRO DE RUEDA	37697	IZQ	3/4"			

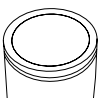



Modelo	Versión	Año	Descripción	Número Lusac	Posición	Diámetro	Notas	Foto Pág.
THUNDERBIRD		85-88	CILINDRO DE RUEDA	37698	DER	3/4"		
		89-96	CILINDRO DE RUEDA	129564	DER	25.4 mm 1"		374
		89-96	CILINDRO DE RUEDA	129564	IZQ	25.4 mm 1"		374
		85-86	CILINDRO MAESTRO	112311		21.0 mm 53/64"		
		87-88	CILINDRO MAESTRO	117583		21.0 & 30.2 mm		
		89-89	CILINDRO MAESTRO	120794		23.8 mm 15/16"		298
		90-94	CILINDRO MAESTRO	122572		25.4 mm 1"	SUPERCARGADO	299
		96-96	CILINDRO MAESTRO	390126		1-1/16"	C/ABS	301
		02-05	CILINDRO MAESTRO	390555		1"		318
		89-89	REP. CIL. MAESTRO Y DE CLUTCH	120795		23.8 mm 15/16"		562
		90-94	REP. CIL. MAESTRO Y DE CLUTCH	120797		25.4 mm 1"		562
	89-96	REPUESTO CILINDRO DE RUEDA	04-112366		25.4 mm 1"			
TOPAZ		84-94	MANGUERA DE FRENOS	4062	DEL DER	16 1/2"		386
		84-94	MANGUERA DE FRENOS	4063	DEL IZQ	16 5/8"		386
		84-94	MANGUERA DE FRENOS	38378	TRAS DER	10.75"		391
		84-94	MANGUERA DE FRENOS	38378	TRAS IZQ	10.75"		391
		84-94	PISTÓN FRENO DE DISCO	108159	DEL	60.0 mm		528
		84-94	REPUESTO FRENO DE DISCO	108241	DEL	60.0 mm		554
		84-94	CILINDRO DE RUEDA	108106	DER	22.2 mm 7/8"		372
		84-94	CILINDRO DE RUEDA	108107	IZQ	22.2 mm 7/8"		372
		84-94	CILINDRO MAESTRO	108151		20.0 mm		297
		84-94	KIT DE PISTÓN Y REPUESTO FD	742324	DEL	60.0 mm		
	84-94	REP. CIL. MAESTRO Y DE CLUTCH	108657		20.0 mm		561	
TRANSIT		10-13	PISTÓN FRENO DE DISCO	851053	DEL	48.0 mm 1-57/64"	CALIPER DOBLE PISTON	533
		10-13	REPUESTO FRENO DE DISCO	21053	DEL	48.0 mm 1-57/64"	CALIPER DOBLE PISTON	549
	CONNECT	10-13	CILINDRO MAESTRO	391254		23.8 mm 15/16"		
		10-12	KIT DE PISTÓN Y REPUESTO FD	742436	DEL	48.0 mm 1-57/64"		
WINDSTAR		95-98	MANGUERA DE FRENOS	380264	DEL DER	18.5"		410
		95-98	MANGUERA DE FRENOS	380265	DEL IZQ	18.25"		410
		95-03	MANGUERA DE FRENOS	380325	TRAS DER	24.75"		413
		95-03	MANGUERA DE FRENOS	380326	TRAS IZQ	24.75"		413
		95-03	MANGUERA DE FRENOS	380531	TRAS IZQ	21"		424
		99-03	MANGUERA DE FRENOS	381281	DEL DER	12.25"		439
		99-03	MANGUERA DE FRENOS	381302	DEL IZQ	10.31"		441
		95-98	PISTÓN FRENO DE DISCO	85438	DEL	65.9 mm 2-19/32"		524
		95-03	PISTÓN FRENO DE DISCO	85492	TRAS	44.0 mm		526
		99-03	PISTÓN FRENO DE DISCO	85814	DEL	48.0 mm 1-57/64"	CALIPER DOBLE PISTON	526
		95-03	REPUESTO FRENO DE DISCO	2492	TRAS	44.0 mm		542
		99-03	REPUESTO FRENO DE DISCO	2814	DEL	48.0 mm 1-57/64"	CALIPER DOBLE PISTON	543
		95-98	REPUESTO FRENO DE DISCO	83691	DEL	65.9 mm 2-19/32"		553
		95-03	CILINDRO DE RUEDA	129564	DER	25.4 mm 1"		374
		95-03	CILINDRO DE RUEDA	129564	IZQ	25.4 mm 1"		374
	95-97	CILINDRO MAESTRO	390248		1-1/16"	S/C DE TRACCIÓN	305	





Modelo	Versión	Año	Descripción	Número Lusac	Posición	Diámetro	Notas	Foto Pág.
FORD								
WINDSTAR		96-98	CILINDRO MAESTRO	390329		1-1/16"	C/C DE TRACCIÓN	309
		97-98	CILINDRO MAESTRO	390395		1"	S/C DE TRACCIÓN	312
		99-00	CILINDRO MAESTRO	390570		1-1/16"	DISCO-TAMBOR S/C DE TRACCIÓN	319
		99-01	CILINDRO MAESTRO	390573		1-1/16"	DISCO-TAMBOR C/C DE TRACCIÓN	319
		00-03	CILINDRO MAESTRO	390581		1"	C/ABS. DISCO-DISCO. C/C DE TRACCIÓN	319
		99-03	CILINDRO MAESTRO	390582		1"	DISCO-DISCO S/C DE TRACCIÓN	319
		02-03	CILINDRO MAESTRO	390810		1-1/16"		329
		95-98	KIT DE PISTÓN Y REPUESTO FD	742339	DEL	65.9 mm 2-19/32"		
		99-03	KIT DE PISTÓN Y REPUESTO FD	742349	DEL	48.0 mm 1-57/64"		
		95-96	REPUESTO CILINDRO DE RUEDA	04-112366		25.4 mm 1"		
GMC								
C-50		83-88	MANGUERA DE FRENOS	0007	TRAS IZQ	18 11/16"		
		83-88	CILINDRO DE RUEDA	34401	IZQ	22.2 mm 7/8"		
		83-88	CILINDRO DE RUEDA	34402	DER	22.2 mm 7/8"		
		83-88	CILINDRO DE RUEDA	78744	IZQ	38.1 mm 1-1/2"		
		83-88	CILINDRO DE RUEDA	78745	DER	38.1 mm 1-1/2"		
		83-88	CILINDRO MAESTRO	116702		44.4 mm 1-3/4"		
C-60 °		83-88	MANGUERA DE FRENOS	0007	TRAS DER	18 11/16"		
		83-88	MANGUERA DE FRENOS	0007	TRAS IZQ	18 11/16"		
		83-88	MANGUERA DE FRENOS	36954	DEL IZQ	23.25"		387
		83-88	MANGUERA DE FRENOS	38563	DEL DER	24.25"		
		89-99	MANGUERA DE FRENOS	380498	TRAS DER	24.25"		
		89-99	MANGUERA DE FRENOS	380499	TRAS IZQ	22.25"		
		83-88	PISTÓN FRENO DE DISCO	85080	DEL Y TRAS	73.0 mm 2-7/8"		
		83-88	CILINDRO DE RUEDA	8852	IZQ	28.5 mm 1-1/8"		
		83-88	CILINDRO DE RUEDA	8853	DER	28.5 mm 1-1/8"		
		83-88	CILINDRO DE RUEDA	24489	DER	41.3 mm 1-5/8"		
		83-88	CILINDRO DE RUEDA	24489	IZQ	41.3 mm 1-5/8"		
		83-88	CILINDRO DE RUEDA	26172	DER	44.4 mm 1-3/4"		
		83-88	CILINDRO DE RUEDA	26172	IZQ	44.4 mm 1-3/4"		
		83-88	CILINDRO DE RUEDA	32349	IZQ	31.7 mm 1-1/4"		
		83-88	CILINDRO DE RUEDA	32350	DER	31.7 mm 1-1/4"		
	83-88	CILINDRO DE RUEDA	32357	IZQ	34.9 mm 1-3/8"			
	83-88	CILINDRO DE RUEDA	32358	DER	34.9 mm 1-3/8"			
	83-88	CILINDRO MAESTRO	116702		44.4 mm 1-3/4"			
C-65		83-85	CILINDRO DE RUEDA	8852	IZQ	28.5 mm 1-1/8"		
		83-85	CILINDRO DE RUEDA	8853	DER	28.5 mm 1-1/8"		
		83-85	CILINDRO DE RUEDA	24489	DER	41.3 mm 1-5/8"		
		83-85	CILINDRO DE RUEDA	24489	IZQ	41.3 mm 1-5/8"		
		83-85	CILINDRO DE RUEDA	26172	DER	44.4 mm 1-3/4"		
		83-85	CILINDRO DE RUEDA	26172	IZQ	44.4 mm 1-3/4"		
		83-85	CILINDRO DE RUEDA	32349	IZQ	31.7 mm 1-1/4"		
		83-85	CILINDRO DE RUEDA	32350	DER	31.7 mm 1-1/4"		
		83-85	CILINDRO DE RUEDA	78744	IZQ	38.1 mm 1-1/2"		
		83-85	CILINDRO DE RUEDA	78744	IZQ	38.1 mm 1-1/2"		
		83-85	CILINDRO DE RUEDA	78745	DER	38.1 mm 1-1/2"		
		83-85	CILINDRO MAESTRO	116702		44.4 mm 1-3/4"		

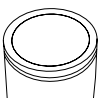



Modelo	Versión	Año	Descripción	Número Lusac	Posición	Diámetro	Notas	Foto Pág.
CANYON		07-12	MANGUERA DE FRENOS	382602	DEL DER	16.5"		476
		07-12	MANGUERA DE FRENOS	382603	DEL DER	20.88"		476
		07-12	MANGUERA DE FRENOS	382606	DEL IZQ	16.25"		476
		07-08	MANGUERA DE FRENOS	382677	TRAS IZQ	16"		481
		07-08	PISTÓN FRENO DE DISCO	851052	N/D	N/D		533
		07-08	REPUESTO FRENO DE DISCO	21052	DEL	45.5 mm		549
		07-10	CILINDRO DE RUEDA	370148	DER	15/16"		378
		07-10	CILINDRO DE RUEDA	370148	IZQ	15/16"		378
		09-12	CILINDRO DE RUEDA	370201	DER	15/16"		381
		09-12	CILINDRO DE RUEDA	370201	IZQ	15/16"		381
JIMMY		07-08	CILINDRO MAESTRO	390845		1"	4X2, 4X4	331
		84-91	CILINDRO DE CLUTCH	37728		20.5 mm	CHOCOLATE	
		90-91	CILINDRO DE CLUTCH	37816		20.6 mm 13/16"	CHOCOLATE	
		90-91	CILINDRO DE CLUTCH	37816		20.6 mm 13/16"		
		03-04	CILINDRO DE CLUTCH	360128		N.R.		
		99-00	CILINDRO MAESTRO	390427		1"	CILINDRO MAESTRO ESTAMPADO CON KT	313
		00-05	CILINDRO MAESTRO	390571		1"	CILINDRO MAESTRO ESTAMPADO CON DX	319
		96-01	MANGUERA DE FRENOS	38871	CTR	18.88"	SPORT UTILITY VEHICLE (4 PTAS)	400
		98-02	MANGUERA DE FRENOS	380469	EXT	10"	4X2	421
		96-05	MANGUERA DE FRENOS	380520	CTR	19.25"	SPORT UTILITY VEHICLE (2 PTAS)	424
		00-00	MANGUERA DE FRENOS	381032	IZQ	19.12"	4X4 SPORT UTILITY VEHICLE (4 PTAS) 110 DIGITO DEL VIN ES 2	431
		00-00	MANGUERA DE FRENOS	381033	DER	19.12"	4X4 SPORT UTILITY VEHICLE (4 PTAS) 110 DIGITO DEL VIN ES 2	431
		98-05	MANGUERA DE FRENOS	381064	EXT	12.73"	ZR2 HIGH WIDER PACKAGE	432
		98-05	MANGUERA DE FRENOS	381065	EXT	11.93"	S/ZR2 HIGH WIDER PACKAGE	433
		00-00	MANGUERA DE FRENOS	381102	DEL IZQ DER	12.19"	4X2 SPORT UTILITY VEHICLE (4 PTAS) 110 DIGITO DEL VIN ES 2	433
	SPORT	00-02	MANGUERA DE FRENOS	381342	DEL IZQ DER	12.45"	4X2	442
	SAFARI		90-02	CILINDRO DE RUEDA	37854	TRAS IZQ DER	7/8"	
		90-94	CILINDRO MAESTRO	390063		28.6 y 40.0 mm	CHOCOLATE	300
		96-03	CILINDRO MAESTRO	390321		1-1/4"	SALIDA PRIMARIA 9/16", SALIDA SECUNDARIA 1/2"	308
		85-02	MANGUERA DE FRENOS	38261	CTR	14.88"		
		90-99	MANGUERA DE FRENOS	38851	DEL IZQ	19.63"	CHOCOLATE	399
		90-99	MANGUERA DE FRENOS	38852	DEL DER	19.63"	CHOCOLATE	399
SAVANA	1500	96-02	CILINDRO DE RUEDA	37985	TRAS IZQ DER	15/16"		369
	1500	96-02	CILINDRO MAESTRO	390363		1-1/8"		310
	1500	03-07	CILINDRO MAESTRO	390843		34mm		331
	1500	08-08	CILINDRO MAESTRO	391179		34mm	S/C FRENOS ACTIVO	347
	1500	08-08	CILINDRO MAESTRO	391251		34mm	C/C FRENOS ACTIVO	
	1500	09-13	CILINDRO MAESTRO	391252		1-5/16"	C/C FRENOS ACTIVO	352
	1500	09-10	CILINDRO MAESTRO	391253		1-5/16"	S/C FRENOS ACTIVO	352





Modelo	Versión	Año	Descripción	Número Lusac	Posición	Diámetro	Notas	Foto Pág.
GMC								
SAVANA	1500	96-02	MANGUERA DE FRENOS	38624	CTR	17.75"		394
	1500	96-02	MANGUERA DE FRENOS	380752	IZQ	22.75"		427
	1500	96-02	MANGUERA DE FRENOS	380753	DER	22.75"		427
	2500	96-02	CILINDRO DE RUEDA	37985	TRAS IZQ DER	15/16"	GASOLINA RINES DE 6 PERNOS	369
	2500	96-02	CILINDRO DE RUEDA	79767	TRAS IZQ DER	26.9 mm 1-1/16"	GASOLINA RINES DE 8 PERNOS	371
	2500	01-02	CILINDRO DE RUEDA	079768	TRAS IZQ DER	30.1 mm 1-3/16"	DIESEL	371
	2500	96-00	CILINDRO DE RUEDA	116359	TRAS IZQ DER	25.4 mm 1"	DIESEL	373
	2500	96-02	CILINDRO MAESTRO	390363		1-1/8"	C/BOOSTER DE VACÍO	310
	2500	96-02	CILINDRO MAESTRO	390364		1-1/4"	HYDROBOOSTER	310
	2500	03-07	CILINDRO MAESTRO	390818		37mm		330
	2500	03-05	CILINDRO MAESTRO	390843		34mm		331
	2500	08-08	CILINDRO MAESTRO	391082		37mm	S/C FRENOS ACTIVO	342
	2500	09-14	CILINDRO MAESTRO	391184		1-1/2"	C/C FRENOS ACTIVO	347
	2500	96-02	MANGUERA DE FRENOS	38624	CTR	17.75"	HYDROBOOSTER	394
	2500	96-02	MANGUERA DE FRENOS	380587	DER	21.33"	HYDROBOOSTER	426
	2500	96-02	MANGUERA DE FRENOS	380588	IZQ	21.33"	HYDROBOOSTER	426
	2500	96-02	MANGUERA DE FRENOS	380752	IZQ	22.75"	C/BOOSTER DE VACÍO	427
	2500	96-02	MANGUERA DE FRENOS	380753	DER	22.75"	C/BOOSTER DE VACÍO	427
	2500 EXT	96-02	CILINDRO DE RUEDA	37985	TRAS IZQ DER	15/16"	GASOLINA RINES DE 6 PERNOS	369
	2500 EXT	96-02	CILINDRO DE RUEDA	79767	TRAS IZQ DER	26.9 mm 1-1/16"	GASOLINA RINES DE 8 PERNOS	371
	2500 EXT	01-01	CILINDRO DE RUEDA	079768	TRAS IZQ DER	30.1 mm 1-3/16"	DIESEL	371
	2500 EXT	96-00	CILINDRO DE RUEDA	116359	TRAS IZQ DER	25.4 mm 1"	DIESEL	373
	2500 EXT	96-02	CILINDRO MAESTRO	390363		1-1/8"	C/BOOSTER DE VACÍO	310
	2500 EXT	96-02	CILINDRO MAESTRO	390364		1-1/4"	HYDROBOOSTER	310
	2500 EXT	03-07	CILINDRO MAESTRO	390818		37mm		330
	2500 EXT	03-05	CILINDRO MAESTRO	390843		34mm		331
	2500 EXT	08-08	CILINDRO MAESTRO	391082		37mm	S/C FRENOS ACTIVO	342
	2500 EXT	09-14	CILINDRO MAESTRO	391184		1-1/2"	C/C FRENOS ACTIVO	347
	2500 EXT	96-02	MANGUERA DE FRENOS	38624	CTR	17.75"	HYDROBOOSTER	394
	2500 EXT	96-02	MANGUERA DE FRENOS	380587	DER	21.33"	HYDROBOOSTER	426
	2500 EXT	96-02	MANGUERA DE FRENOS	380588	IZQ	21.33"	HYDROBOOSTER	426
	2500 EXT	96-02	MANGUERA DE FRENOS	380752	IZQ	22.75"	C/BOOSTER DE VACÍO	427
2500 EXT	96-02	MANGUERA DE FRENOS	380753	DER	22.75"	C/BOOSTER DE VACÍO	427	
SIERRA	CLASSIC C2500	99-00	CILINDRO DE RUEDA	79767	TRAS IZQ DER	26.9 mm 1-1/16"		371
	CLASSIC C2500	99-00	CILINDRO MAESTRO	390257		1-1/4"		306
	CLASSIC C2500	99-00	CILINDRO MAESTRO	390259		40mm & 1/8"		306
	CLASSIC C2500	99-00	MANGUERA DE FRENOS	38624	CTR	17.75"		394
	CLASSIC C2500	99-00	MANGUERA DE FRENOS	380248	IZQ	20.63"		410
	CLASSIC C2500	99-00	MANGUERA DE FRENOS	380249	DER	20.63"		410

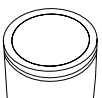

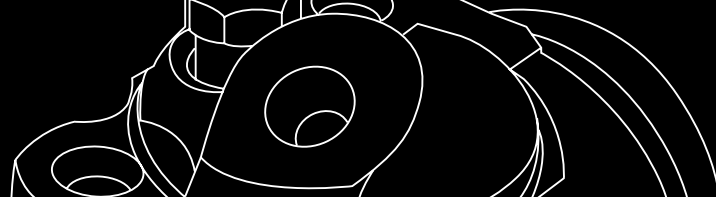

Modelo	Versión	Año	Descripción	Número Lusac	Posición	Diámetro	Notas	Foto Pág.	
SIERRA	CLASSIC K2500	99-00	CILINDRO DE RUEDA	79767	TRAS IZQ DER	26.9 mm 1-1/16"		371	
	CLASSIC K2500	99-00	CILINDRO MAESTRO	390257		1-1/4"		306	
	CLASSIC K2500	99-00	CILINDRO MAESTRO	390259		40mm & 1/8"		306	
	CLASSIC K2500	99-00	MANGUERA DE FRENOS	38624	CTR	17.75"		394	
	CLASSIC K2500	99-00	MANGUERA DE FRENOS	380533	IZQ	25.5"		424	
	CLASSIC K2500	99-00	MANGUERA DE FRENOS	380534	DER	25.5"		424	
			01-03	CILINDRO DE CLUTCH	360107		Concentrico	CHOCOLATE	
	1500 CLASSIC	07-07	CILINDRO DE RUEDA	370180	TRAS IZQ DER	15/16"			380
	1500 CLASSIC	07-07	CILINDRO DE RUEDA	370181	TRAS IZQ DER	26.9 mm 1-1/16"			380
	1500 CLASSIC	07-07	CILINDRO MAESTRO	390806		1-1/4"			329
	1500 CLASSIC	07-07	CILINDRO MAESTRO	390818		37mm			330
	1500 CLASSIC	07-07	CILINDRO MAESTRO	390843		34mm		HYBRID	331
	1500 CLASSIC	07-07	CILINDRO MAESTRO	390930		1-1/8"			335
	1500 CLASSIC	07-07	MANGUERA DE FRENOS	382412	IZQ	28.38"		4X2, 4X4	464
	1500 CLASSIC	07-07	MANGUERA DE FRENOS	382414	DER	27.38"		4X2, 4X4	464
	1500 CLASSIC	07-07	MANGUERA DE FRENOS	382418	DER	30.75"		4X2, 4X4	464
	1500	05-08	CILINDRO DE RUEDA	370180	DER	15/16"			380
	1500	07-08	CILINDRO DE RUEDA	370180	IZQ	15/16"			380
	1500	05-08	CILINDRO DE RUEDA	370181	TRAS IZQ DER	26.9 mm 1-1/16"			380
	1500	09-14	CILINDRO DE RUEDA	370200	IZQ	1 1/16"			381
	1500	09-14	CILINDRO DE RUEDA	370201	DER	15/16"			381
	1500	99-02	CILINDRO MAESTRO	390541		34mm		C/BOOSTER DE VACÍO	317
	1500	99-02	CILINDRO MAESTRO	390542		37mm		HYDROBOOSTER	318
	1500	03-06	CILINDRO MAESTRO	390806		1-1/4"			329
	1500	03-03	CILINDRO MAESTRO	390818		37mm		HYDROBOOSTER	330
	1500	04-10	CILINDRO MAESTRO	390843		34mm			331
	1500	05-07	CILINDRO MAESTRO	390930		1-1/8"			335
	1500	07-08	CILINDRO MAESTRO	390986		1-1/4"			338
	1500	07-07	CILINDRO MAESTRO	391080		28.5 mm 1-1/8"			341
	1500	07-14	CILINDRO MAESTRO	391169		1-1/8"			346
	1500	09-14	CILINDRO MAESTRO	391172		1-1/4"			346
	1500	99-06	MANGUERA DE FRENOS	381272	CTR	22.5"			439
	1500	99-01	MANGUERA DE FRENOS	381273	IZQ	14.25"			439
	1500	99-02	MANGUERA DE FRENOS	381298	IZQ	28.15"		4X2	441
	1500	99-02	MANGUERA DE FRENOS	381299	DER	28.15"		4X2	441
	1500	02-04	MANGUERA DE FRENOS	382396	IZQ	16.38"			463
	1500	02-04	MANGUERA DE FRENOS	382398	DER	17.19"			463
	1500	01-01	MANGUERA DE FRENOS	382406	DER	18.5"			464
	1500	99-06	MANGUERA DE FRENOS	382412	IZQ	28.38"		4X2, 4X4	464
	1500	99-06	MANGUERA DE FRENOS	382414	DER	27.38"		4X2, 4X4	464
	1500	03-05	MANGUERA DE FRENOS	382415	IZQ	29.5"		5.3 LTS 4X2	464
	1500	03-05	MANGUERA DE FRENOS	382416	DER	30.5"			464





Modelo	Versión	Año	Descripción	Número Lusac	Posición	Diámetro	Notas	Foto Pág.	
GMC	1500	06-06	MANGUERA DE FRENOS	382418	DER	30.75"		464	
	1500	03-05	MANGUERA DE FRENOS	382612	EXT	13"	DIRECCIÓN EN 4 RUEDAS	477	
	1500 HD CLASSIC	07-07	CILINDRO MAESTRO	390818		37mm		330	
	1500 HD CLASSIC	07-07	MANGUERA DE FRENOS	381272	CTR	22.5"		439	
	1500 HD CLASSIC	07-07	MANGUERA DE FRENOS	382396	IZQ	16.38"		463	
	1500 HD CLASSIC	07-07	MANGUERA DE FRENOS	382398	DER	17.19"		463	
	1500 HD CLASSIC	07-07	MANGUERA DE FRENOS	382417	IZQ	31.25"		464	
	1500 HD CLASSIC	07-07	MANGUERA DE FRENOS	382419	DER	31.25"		465	
	1500 HD	01-02	CILINDRO MAESTRO	390541		34mm	C/BOOSTER DE VACÍO	317	
	1500 HD	01-02	CILINDRO MAESTRO	390542		37mm	HYDROBOOSTER	318	
	1500 HD	03-03	CILINDRO MAESTRO	390806		1-1/4"	C/BOOSTER DE VACÍO	329	
	1500 HD	05-06	CILINDRO MAESTRO	390818		37mm		330	
	1500 HD	03-03	CILINDRO MAESTRO	390818		37mm	HYDROBOOSTER	330	
	1500 HD	01-03	MANGUERA DE FRENOS	381272	CTR	22.5"		439	
	1500 HD	01-03	MANGUERA DE FRENOS	382417	IZQ	31.25"		464	
	1500 HD	05-06	MANGUERA DE FRENOS	382417	IZQ	31.25"		464	
	1500 HD	01-03	MANGUERA DE FRENOS	382419	DER	31.25"		465	
	1500 HD	05-06	MANGUERA DE FRENOS	382419	DER	31.25"		465	
	SIERRA	2500	99-02	CILINDRO MAESTRO	390542		37mm		318
		2500	03-04	CILINDRO MAESTRO	390818		37mm		330
		2500	99-04	MANGUERA DE FRENOS	381272	CTR	22.5"		439
		2500	02-04	MANGUERA DE FRENOS	382399	DER	22"		464
		2500	99-04	MANGUERA DE FRENOS	382417	IZQ	31.25"		464
		2500	99-04	MANGUERA DE FRENOS	382419	DER	31.25"		465
		2500	04-04	MANGUERA DE FRENOS	382696	IZQ	16.19"		483
		2500 HD	06-06	CILINDRO MAESTRO	390818		37mm		330
		2500 HD	06-06	MANGUERA DE FRENOS	381272	CTR	22.5"		439
		2500 HD	06-06	MANGUERA DE FRENOS	382399	DER	22"		464
		2500 HD	06-06	MANGUERA DE FRENOS	382417	IZQ	31.25"		464
		2500 HD	06-06	MANGUERA DE FRENOS	382419	DER	31.25"		465
		2500 HD	06-06	MANGUERA DE FRENOS	382696	IZQ	16.19"		483
		2500 HD CLASSIC	07-07	CILINDRO MAESTRO	390818		37mm		330
		2500 HD CLASSIC	07-07	MANGUERA DE FRENOS	381272	CTR	22.5"		439
2500 HD CLASSIC		07-07	MANGUERA DE FRENOS	382399	DER	22"		464	
2500 HD CLASSIC		07-07	MANGUERA DE FRENOS	382417	IZQ	31.25"		464	
2500 HD CLASSIC		07-07	MANGUERA DE FRENOS	382419	DER	31.25"		465	
2500 HD CLASSIC		07-07	MANGUERA DE FRENOS	382696	IZQ	16.19"		483	
2500 HD		01-02	CILINDRO MAESTRO	390542		37mm		318	
2500 HD		03-05	CILINDRO MAESTRO	390818		37mm		330	
2500 HD		07-08	CILINDRO MAESTRO	391081		37mm	C DE FRENOS DE REMOLQUE	341	
2500 HD		07-08	CILINDRO MAESTRO	391082		37mm	S/C DE FRENOS DE REMOLQUE	342	

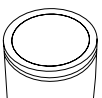



Modelo	Versión	Año	Descripción	Número Lusac	Posición	Diámetro	Notas	Foto Pág.	
SONOMA	2500 HD	09-10	CILINDRO MAESTRO	391183		1-1/2"	S/C FRENOS ACTIVO; S/C DE FRENOS DE REMOLQUE	347	
	2500 HD	09-14	CILINDRO MAESTRO	391184		1-1/2"		347	
	2500 HD	01-05	MANGUERA DE FRENOS	381272	CTR	22.5"		439	
	2500 HD	02-05	MANGUERA DE FRENOS	382399	DER	22"		464	
	2500 HD	01-05	MANGUERA DE FRENOS	382417	IZQ	31.25"		464	
	2500 HD	01-05	MANGUERA DE FRENOS	382419	DER	31.25"		465	
	2500 HD	12-12	MANGUERA DE FRENOS	382692	IZQ	18"		482	
	2500 HD	04-05	MANGUERA DE FRENOS	382696	IZQ	16.19"		483	
	3500	01-02	CILINDRO DE CLUTCH	360107		Concentrico			
		84-91	CILINDRO DE CLUTCH	37728		20.5 mm	CHOCOLATE		
		90-91	CILINDRO DE CLUTCH	37816		20.6 mm 13/16"	CHOCOLATE		
		03-03	CILINDRO DE CLUTCH	360128		N.R.	CHOCOLATE		
		03-03	CILINDRO DE RUEDA	37854	TRAS IZQ DER	7/8"		367	
		92-02	CILINDRO DE RUEDA	37967	TRAS IZQ DER	13/16"		369	
		00-04	CILINDRO MAESTRO	390571		1"		319	
		00-04	MANGUERA DE FRENOS	38871	CTR	18.88"	S/HIGH WIDER PACKAGE	400	
		98-03	MANGUERA DE FRENOS	380469	DER	10"	4X4 C/HIGH WIDER PACKAGE	421	
		00-03	MANGUERA DE FRENOS	381065	IZQ	11.93"	4X4 C/HIGH WIDER PACKAGE	433	
		00-03	MANGUERA DE FRENOS	381345	DEL IZQ DER	12.37"	4X2	443	
	V20		88-88	CILINDRO DE CLUTCH	37815		20.6 mm 13/16"	CHOCOLATE	
YUKON		07-14	MANGUERA DE FRENOS	382615	TRAS IZQ	15.5" & 15"		477	
		07-14	REPUESTO FRENO DE DISCO	21045	TRAS	50.8mm 2"		548	
		07-08	CILINDRO MAESTRO	390986		1-1/4"		338	
		09-14	CILINDRO MAESTRO	391172		1-1/4"		346	
HONDA									
ACCORD		96-97	MANGUERA DE FRENOS	38831	DEL DER	27.88"		398	
		96-97	MANGUERA DE FRENOS	38832	DEL IZQ	27.88"		398	
		96-97	MANGUERA DE FRENOS	380395	TRAS DER	8"		418	
		96-97	MANGUERA DE FRENOS	380395	TRAS IZQ	8"		418	
		96-97	MANGUERA DE FRENOS	380549	TRAS IZQ	15"		425	
		98-02	MANGUERA DE FRENOS	381025	DEL DER	17.28"		431	
		98-02	MANGUERA DE FRENOS	381026	DEL IZQ	17.28"		431	
		98-02	MANGUERA DE FRENOS	381046	TRAS IZQ	12.5"		431	
		98-02	MANGUERA DE FRENOS	381099	TRAS DER	17.94"		433	
		98-02	MANGUERA DE FRENOS	381100	TRAS IZQ	17.94"		433	
		03-07	MANGUERA DE FRENOS	381544	DEL DER	17.62"		448	
		03-07	MANGUERA DE FRENOS	381545	DEL IZQ	17.62"		448	
		03-07	MANGUERA DE FRENOS	381546	TRAS DER	18.62"		448	
		03-07	MANGUERA DE FRENOS	381547	TRAS IZQ	18.62"		448	
		08-12	MANGUERA DE FRENOS	382554	DEL DER	20.5"		472	
		08-12	MANGUERA DE FRENOS	382555	DEL IZQ	20.5"		472	
		96-12	PISTÓN FRENO DE DISCO	85393	DEL	57.1 mm 2-1/4"		524	
		96-12	REPUESTO FRENO DE DISCO	1458	DEL	57.1 mm 2-1/4"		537	
		96-07	REPUESTO FRENO DE DISCO	2105	TRAS	30.1 mm 1-3/16"		539	
	EX		94-95	CILINDRO DE RUEDA	37858	IZQ	13/16"		367
	EX		94-95	CILINDRO DE RUEDA	37859	DER	13/16"		367
	EX		03-07	CILINDRO DE RUEDA	370123	DER	13/16"		377





Modelo	Versión	Año	Descripción	Número Lusac	Posición	Diámetro	Notas	Foto Pág.	
HONDA									
ACCORD	EX	03-07	CILINDRO DE RUEDA	370127	IZQ	13/16"		377	
	V6	98-00	CILINDRO DE RUEDA	37858	IZQ	13/16"		367	
	V6	98-00	CILINDRO DE RUEDA	37859	DER	13/16"		367	
	V6	98-02	MANGUERA DE FRENOS	381025	DEL DER	17.28"		431	
	V6	98-02	MANGUERA DE FRENOS	381026	DEL IZQ	17.28"		431	
	V6	01-02	MANGUERA DE FRENOS	381046	DEL IZQ	12.5"		431	
	V6	98-00	MANGUERA DE FRENOS	381046	TRAS IZQ	12.5"		431	
	V6	98-02	MANGUERA DE FRENOS	381099	TRAS DER	17.94"		433	
	V6	98-02	MANGUERA DE FRENOS	381100	TRAS IZQ	17.94"		433	
	V6	03-07	MANGUERA DE FRENOS	381544	DEL DER	17.62"		448	
	V6	03-07	MANGUERA DE FRENOS	381545	DEL IZQ	17.62"		448	
	V6	03-07	MANGUERA DE FRENOS	381546	TRAS DER	18.62"		448	
	V6	03-07	MANGUERA DE FRENOS	381547	TRAS IZQ	18.62"		448	
	V6	08-12	MANGUERA DE FRENOS	382554	DEL DER	20.5"		472	
	V6	08-12	MANGUERA DE FRENOS	382555	DEL IZQ	20.5"		472	
	V6	98-06	PISTÓN FRENO DE DISCO	85393	DEL	57.1 mm 2-1/4"		524	
	V6	03-07	REPUESTO FRENO DE DISCO	2105	TRAS	30.1 mm 1-3/16"		539	
	V6	98-06	REPUESTO FRENO DE DISCO	2221	DEL	57.1 mm 2-1/4"			
	V6	98-02	REPUESTO FRENO DE DISCO	21310	TRAS	33.7mm		551	
			90-97	CILINDRO DE CLUTCH	37889		19.0 mm 3/4"	NACIONAL	
			98-01	CILINDRO DE CLUTCH	350110		18.0 mm		
			03-06	CILINDRO DE CLUTCH	360125		19.0 mm 3/4"		
			96-02	CILINDRO DE RUEDA	37858	IZQ	13/16"		367
			96-02	CILINDRO DE RUEDA	37859	DER	13/16"		367
			96-97	CILINDRO MAESTRO	39882		15/16"	S/ABS 4 CIL	295
			96-97	CILINDRO MAESTRO	39970		1"	C/ABS	296
			98-02	CILINDRO MAESTRO	390417		15/16"		312
			98-02	CILINDRO MAESTRO	390418		1"	C/ABS	312
			01-02	CILINDRO MAESTRO	390564		1"	S/ABS V6	318
			03-07	CILINDRO MAESTRO	390783		13/16"		328
			03-07	CILINDRO MAESTRO	390784		20.6 mm 13/16"	3 6 V	
			08-12	CILINDRO MAESTRO	391101		13/16"		342
			86-89	MANGUERA DE FRENOS	38855	DEL IZQ	26.25"	CHOCOLATE	399
		97-97	MANGUERA DE FRENOS	381008	TRAS	8.13"	CHOCOLATE	431	
CIVIC	COUPE	97-02	MANGUERA DE FRENOS	380062	DEL DER	18.5"		405	
	COUPE	97-00	MANGUERA DE FRENOS	380064	TRAS IZQ	19"		405	
	COUPE	03-05	MANGUERA DE FRENOS	381566	TRAS DER	18.62"		449	
	COUPE	03-05	MANGUERA DE FRENOS	381567	TRAS IZQ	18.62"		449	
	COUPE EX	06-10	CILINDRO DE RUEDA	370182	IZQ	3/4"		380	
	COUPE EX	06-10	CILINDRO MAESTRO	391002		3/4"		338	
	CX	93-96	CILINDRO DE RUEDA	37846	IZQ	3/4"		366	
	CX	93-96	CILINDRO DE RUEDA	37847	DER	3/4"		366	
	CX	96-96	CILINDRO MAESTRO	390328		13/16"	2 PTAS HATCHBACK	309	
	CX, COUPE, SEDAN	96-96	CILINDRO MAESTRO	390328		13/16"		309	
	CX, DX, HX	96-96	MANGUERA DE FRENOS	380754	IZQ	16"		427	
	CX	96-96	MANGUERA DE FRENOS	380756	DER	16.25"		427	
	CX	96-96	MANGUERA DE FRENOS	380758	IZQ	16.25"		427	
	CX, DX, HX	96-96	MANGUERA DE FRENOS	380785	DER	17.25"	CX	428	
	SEDAN	97-01	CILINDRO DE RUEDA	37846	IZQ	3/4"		366	
	SEDAN	97-01	CILINDRO DE RUEDA	37847	DER	3/4"		366	

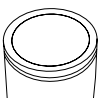



Modelo	Versión	Año	Descripción	Número Lusac	Posición	Diámetro	Notas	Foto Pág.	
CIVIC	SEDAN	03-06	CILINDRO DE RUEDA	370123	DER	13/16"		377	
	SEDAN	03-06	CILINDRO DE RUEDA	370127	IZQ	13/16"		377	
	SEDAN	02-02	CILINDRO DE RUEDA	370131	DER	3/4"		378	
	SEDAN	02-02	CILINDRO DE RUEDA	370132	IZQ	3/4"		378	
	SEDAN	99-06	CILINDRO DE RUEDA	370149	DER	3/4"		378	
	SEDAN	99-06	CILINDRO DE RUEDA	370152	IZQ	3/4"		379	
	SEDAN	07-13	CILINDRO DE RUEDA	370182	DER	3/4"		380	
	SEDAN	07-13	CILINDRO DE RUEDA	370182	IZQ	3/4"		380	
	SEDAN	97-01	CILINDRO MAESTRO	390323		7/8"	C/ABS EX, SI	308	
	SEDAN	97-01	CILINDRO MAESTRO	390328		13/16"	S/ABS 4 PTAS	309	
	SEDAN	99-01	CILINDRO MAESTRO	390550		15/16"	C/ABS EX, SI	318	
	SEDAN	02-02	CILINDRO MAESTRO	390722		7/8"	SEDAN LX Y EX C/ABS	324	
	SEDAN	03-06	CILINDRO MAESTRO	390746		13/16"	SEDAN LX S/ABS	325	
	SEDAN	02-06	CILINDRO MAESTRO	390746		13/16"	SEDAN LX Y EX S/ABS	325	
	SEDAN	02-04	CILINDRO MAESTRO	390807		7/8"		329	
	SEDAN	04-05	CILINDRO MAESTRO	390808		7/8"		329	
	SEDAN	07-13	CILINDRO MAESTRO	391002		3/4"		338	
	SEDAN	97-01	MANGUERA DE FRENOS	38218	TRAS DER	10.81"		389	
	SEDAN	97-01	MANGUERA DE FRENOS	38218	TRAS IZQ	10.81"		389	
	SEDAN	97-01	MANGUERA DE FRENOS	380756	DEL DER	16.25"		427	
	SEDAN	99-01	MANGUERA DE FRENOS	380758	DEL IZQ	16.25"		427	
	SEDAN	97-01	MANGUERA DE FRENOS	380758	DEL IZQ	16.25"	SI VIENE EQUIPADO CON TRANSMISIÓN ESTÁNDARDD LAS MANGUERAS SON 380754 DEL IZQ Y 380785 DEL DER	427	
	SEDAN	02-06	MANGUERA DE FRENOS	381466	DEL DER	21.88"		446	
	SEDAN	02-06	MANGUERA DE FRENOS	381467	DEL IZQ	21.88"		446	
	SEDAN	02-06	MANGUERA DE FRENOS	381499	TRAS DER	12.13"		447	
	SEDAN	02-06	MANGUERA DE FRENOS	381499	TRAS IZQ	12.13"		447	
	SEDAN	03-06	MANGUERA DE FRENOS	381566	TRAS DER	18.62"		449	
	SEDAN	03-06	MANGUERA DE FRENOS	381567	TRAS IZQ	18.62"		449	
	SEDAN	07-13	MANGUERA DE FRENOS	382549	DEL DER	12.5"		471	
	SEDAN	07-13	MANGUERA DE FRENOS	382550	DEL IZQ	22.25"		471	
	SEDAN	07-11	MANGUERA DE FRENOS	382551	DEL DER	14.56"		471	
	SEDAN	07-11	MANGUERA DE FRENOS	382551	DEL IZQ	14.56"		471	
	SEDAN	07-11	MANGUERA DE FRENOS	382551	TRAS DER	14.56"		471	
	SEDAN	07-11	MANGUERA DE FRENOS	382551	TRAS IZQ	14.56"		471	
	SEDAN	07-11	MANGUERA DE FRENOS	382552	TRAS DER	21.62"		471	
	SEDAN	07-11	MANGUERA DE FRENOS	382553	TRAS IZQ	21.06"		472	
	SEDAN	97-13	PISTÓN FRENO DE DISCO	85402	DEL	54.0 mm 2-1/8"		524	
	SEDAN	97-13	REPUESTO FRENO DE DISCO	1595	DEL	54.0 mm 2-1/8"		537	
	SEDAN	07-13	REPUESTO FRENO DE DISCO	2027	TRAS	34.0 mm			
			92-00	CILINDRO DE CLUTCH	39903		15.8 mm 5/8"	NACIONAL	
			92-00	CILINDRO DE CLUTCH	360025		19.0 mm 3/4"	NACIONAL	
			92-95	CILINDRO MAESTRO	390044		23.8 mm 15/16"	C/ABS	299
			96-98	CILINDRO MAESTRO	390331		22.2 mm 7/8"		309
			09-10	CILINDRO MAESTRO	391227		19.0 mm 3/4"	COUPE	
			07-11	CILINDRO MAESTRO	391227		19.0 mm 3/4"	SEDAN	
		89-91	MANGUERA DE FRENOS	38857	DEL IZQ	27"	CHOCOLATE	399	
		92-95	MANGUERA DE FRENOS	380055	DEL DER	26.25"	S/ABS CHOCOLATE	405	





Modelo	Versión	Año	Descripción	Número Lusac	Posición	Diámetro	Notas	Foto Pág.
HONDA								
CIVIC		92-95	MANGUERA DE FRENOS	380056	DEL DER	26.55"	C/ABS CHOCOLATE	405
		92-95	MANGUERA DE FRENOS	380058	DEL IZQ	26.25"	CHOCOLATE	405
		03-05	MANGUERA DE FRENOS	381554	DEL DER	17.62"	4 PTAS	448
		03-05	MANGUERA DE FRENOS	381555	DEL IZQ	23.13"	4 PTAS	448
		01-05	MANGUERA DE FRENOS	381556	DEL DER	23"	2 PTAS	449
		01-05	MANGUERA DE FRENOS	381557	DEL IZQ	23"		449
CR-V		02-04	MANGUERA DE FRENOS	382428	TRAS DER	19.25"		465
		02-04	MANGUERA DE FRENOS	382428	TRAS IZQ	19.25"		465
		05-06	MANGUERA DE FRENOS	382556	TRAS DER	20.38"		472
		05-06	MANGUERA DE FRENOS	382556	TRAS IZQ	20.38"		472
		07-11	MANGUERA DE FRENOS	382559	DEL IZQ	22.31"		472
		07-11	MANGUERA DE FRENOS	382560	DEL DER	18.44"		472
		07-11	PISTÓN FRENO DE DISCO	851029	DEL	N/D		532
		02-09	PISTÓN FRENO DE DISCO	851330	DEL	57.1 mm 2-1/4"		534
		02-09	PISTÓN FRENO DE DISCO	851340	TRAS	38.1 mm 1-1/2"		534
		07-11	REPUESTO FRENO DE DISCO	21041	DEL	45.5 mm		548
		02-09	REPUESTO FRENO DE DISCO	21330	DEL	57.1 mm 2-1/4"		551
		02-09	REPUESTO FRENO DE DISCO	21341	TRAS	38.1 mm 1-1/2"		551
		98-01	CILINDRO DE CLUTCH	360025		19.0 mm 3/4"		
		02-04	CILINDRO DE CLUTCH	360125		19.0 mm 3/4"	NACIONAL	
		97-01	CILINDRO DE RUEDA	37858	IZQ	13/16"		367
		97-01	CILINDRO DE RUEDA	37859	DER	13/16"		367
		02-04	CILINDRO MAESTRO	390721		15/16"		324
		02-04	CILINDRO MAESTRO	390730		15/16"		324
		07-11	CILINDRO MAESTRO	390997		7/8"		338
		05-06	CILINDRO MAESTRO	390998		1"		338
	07-10	KIT DE PISTÓN Y REPUESTO FD	742311	DEL	45.5 mm			
DEL SOL		93-97	CILINDRO DE CLUTCH	39903		15.8 mm 5/8"	CHOCOLATE	
		93-97	CILINDRO DE CLUTCH	360025		19.0 mm 3/4"	CHOCOLATE	
		95-97	CILINDRO MAESTRO	390044		23.8 mm 15/16"	CHOCOLATE	299
ELEMENT		03-08	CILINDRO DE CLUTCH	360125		19.0 mm 3/4"	CHOCOLATE	
FIT		06-08	MANGUERA DE FRENOS	381499	TRAS DER	12.13"		447
		06-08	MANGUERA DE FRENOS	381499	TRAS IZQ	12.13"		447
		06-14	CILINDRO DE RUEDA	370182	IZQ	3/4"		380
		07-08	CILINDRO MAESTRO	391000		7/8"		338
		09-11	CILINDRO MAESTRO	391228		3/4"		351
		12-14	CILINDRO MAESTRO	391363		19.0 mm 3/4"		
ODYSSEY		00-04	MANGUERA DE FRENOS	381248	TRAS DER	10.89"		438
		00-04	MANGUERA DE FRENOS	381248	TRAS IZQ	10.89"		438
		00-04	MANGUERA DE FRENOS	381261	DEL DER	17.75"		438
		00-04	MANGUERA DE FRENOS	381261	DEL IZQ	17.75"		438
		05-10	MANGUERA DE FRENOS	382557	DEL DER	18.5"		472
		05-10	MANGUERA DE FRENOS	382557	DEL IZQ	18.5"		472
		05-10	MANGUERA DE FRENOS	382558	TRAS DER	8.62"		472
		05-10	MANGUERA DE FRENOS	382558	TRAS IZQ	8.62"		472
		00-10	PISTÓN FRENO DE DISCO	85135	DEL	64.3 mm 2-17/32"		519
	09-10	PISTÓN FRENO DE DISCO	851029	DEL	N/D		532	

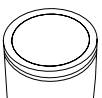



Modelo	Versión	Año	Descripción	Número Lusac	Posición	Diámetro	Notas	Foto Pág.
ODYSSEY		00-10	REPUESTO FRENO DE DISCO	2135	DEL	64.3 mm 2-17/32"		540
		09-10	REPUESTO FRENO DE DISCO	21041	DEL	45.5 mm		548
		99-01	CILINDRO DE RUEDA	370087	DER	7/8"		375
		99-01	V	370088	IZQ	7/8"		376
		00-04	CILINDRO MAESTRO	390551		26.9 mm 1-1/16"		
		00-04	CILINDRO MAESTRO	390556		1-1/16"		318
		05-10	CILINDRO MAESTRO	391004		7/8"		339
		09-10	KIT DE PISTÓN Y REPUESTO FD	742311	DEL	45.5 mm		
		99-99	MANGUERA DE FRENOS	381248	TRAS	10.89"		438
		99-99	MANGUERA DE FRENOS	381261	DEL IZQ	17.75"		438
PASSPORT		01-02	CILINDRO DE CLUTCH	37889		19.0 mm 3/4"	CHOCOLATE	
		94-97	CILINDRO DE CLUTCH	39804		15.8 mm 5/8"		
		98-00	CILINDRO DE CLUTCH	350123		15.8 mm 5/8"	CHOCOLATE	
		94-00	CILINDRO DE CLUTCH	360033		22.2 mm 7/8"	CHOCOLATE	
PILOT		03-08	MANGUERA DE FRENOS	381261	DEL DER	17.75"		438
		03-08	MANGUERA DE FRENOS	381261	DEL IZQ	17.75"		438
		03-08	MANGUERA DE FRENOS	381586	TRAS DER	14.45"		449
		03-08	MANGUERA DE FRENOS	381586	TRAS IZQ	14.45"		449
		03-08	PISTÓN FRENO DE DISCO	85476	TRAS	38.1 mm 1-1/2"		525 V
		03-08	PISTÓN FRENO DE DISCO	853220	DEL	63.5 mm 2-1/2"		534
		03-08	REPUESTO FRENO DE DISCO	2476	TRAS	38.1 mm 1-1/2"		
		03-08	REPUESTO FRENO DE DISCO	21072	DEL	63.5 mm 2-1/2"		550
		03-08	CILINDRO MAESTRO	391007		1-1/16"		339
		09-14	CILINDRO MAESTRO	391100		7/8"		342
	03-08	KIT DE PISTÓN Y REPUESTO FD	742396	TRAS	38.1 mm 1-1/2"	CUBREPOLVO SUAVE		
PRELUDE		92-01	CILINDRO DE CLUTCH	37889		19.0 mm 3/4"		
RIDGELINE		07-14	MANGUERA DE FRENOS	382426	DEL DER	18.63"		465
		07-14	MANGUERA DE FRENOS	382426	DEL IZQ	18.63"		465
		06-08	CILINDRO MAESTRO	391007		1-1/16"		339
		09-14	CILINDRO MAESTRO	391225		1"		350
		06-06	MANGUERA DE FRENOS	382426	DEL IZQ DER	18.63"		465
HUMMER								
H2	SUT	05-07	CILINDRO MAESTRO	390542		37mm	C/ABS, TCS, R-17"	318
	SUT	05-07	MANGUERA DE FRENOS	382417	DEL IZQ	31.25"		464
	SUT	05-07	MANGUERA DE FRENOS	382419	DEL DER	31.25"		465
	SUT	05-07	MANGUERA DE FRENOS	382608	TRAS IZQ	11.25"		476
	SUT	05-07	MANGUERA DE FRENOS	382696	TRAS DER	16.19"		483
	SUT	05-09	PISTÓN FRENO DE DISCO	851070	DEL Y TRAS	57.1 mm 2-1/4"	CALIPER DOBLE PISTON	533
	SUT	05-09	REPUESTO FRENO DE DISCO	2107	DEL Y TRAS	57.1 mm 2-1/4"	CALIPER DOBLE PISTON	539
	SUV	05-07	CILINDRO MAESTRO	390542		37mm	C/ABS, TCS, R-17"	318
	SUV	05-07	MANGUERA DE FRENOS	382417	DEL IZQ	31.25"		464
	SUV	05-07	MANGUERA DE FRENOS	382419	DEL DER	31.25"		465
	SUV	05-07	MANGUERA DE FRENOS	382608	TRAS IZQ	11.25"		476
	SUV	05-07	MANGUERA DE FRENOS	382696	TRAS DER	16.19"		483
	SUV	05-09	PISTÓN FRENO DE DISCO	851070	DEL Y TRAS	57.1 mm 2-1/4"	CALIPER DOBLE PISTON	533
	SUV	05-09	REPUESTO FRENO DE DISCO	2107	DEL Y TRAS	57.1 mm 2-1/4"	CALIPER DOBLE PISTON	539

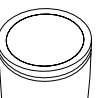



Modelo	Versión	Año	Descripción	Número Lusac	Posición	Diámetro	Notas	Foto Pág.
HYUNDAI								
ACCENT		07-07	CILINDRO DE RUEDA	3700922	TRAS IZQ	22.2 mm 7/8"	FABRICADO EN USA	
		07-07	CILINDRO DE RUEDA	3700922	TRAS DER	22.2 mm 7/8"	FABRICADO EN USA	
I10		12-14	CILINDRO DE RUEDA	3700922	TRAS IZQ	22.2 mm 7/8"		
		12-14	CILINDRO DE RUEDA	3700922	TRAS DER	22.2 mm 7/8"		
INFINITI								
I-30		95-01	CILINDRO DE CLUTCH	350081		15.8 mm 5/8"		
		00-01	KIT DE PISTÓN Y REPUESTO FD	742398	DEL	57.1 mm 2-1/4"		
QX4		02-03	CILINDRO MAESTRO	390774		25.4 mm 1"	FABRICADO EN USA	
QX56		04-10	CILINDRO MAESTRO	391072		1-3/16"		341
		04-06	MANGUERA DE FRENOS	382564	IZQ	18.88"		472
QX56		04-06	MANGUERA DE FRENOS	382565	DER	18.88"		473
		04-10	MANGUERA DE FRENOS	382567	DER	15"		473
INTERNACIONAL								
CF500		06-13	KIT DE PISTÓN Y REPUESTO FD	742350	DEL TRAS	59.5 mm 2-11/32"		
CF600		06-13	KIT DE PISTÓN Y REPUESTO FD	742350	DEL TRAS	59.5 mm 2-11/32"		
ISUZU								
AMIGO		89-01	CILINDRO DE CLUTCH	37833		22.2 mm 7/8"		
		89-95	CILINDRO DE CLUTCH	39804		15.8 mm 5/8"		
		98-01	CILINDRO DE CLUTCH	350123		15.8 mm 5/8"		
		98-99	CILINDRO DE CLUTCH	360033		22.2 mm 7/8"		
		00-00	CILINDRO DE RUEDA	37599	TRAS IZQ DER	7/8"		365
		93-93	CILINDRO MAESTRO	390161		23.8 mm 15/16"		301
		98-00	MANGUERA DE FRENOS	381096	DEL IZQ	16.31"		
ELF-200		09-12	KIT DE PISTÓN Y REPUESTO FD	742421	DEL	50.8 mm 2"		
		09-12	REPUESTO FRENO DE DISCO	21035	DEL	50.8 mm 2"		548
ELF-300		09-11	CILINDRO MAESTRO	39009916		34.9 mm 1-3/8"		361
		08-09	KIT DE PISTÓN Y REPUESTO FD	742405	DEL	57.1 mm 2-1/4"		
		08-09	REPUESTO FRENO DE DISCO	21016	DEL	57.1 mm 2-1/4"		546
ELF-400		07-11	CILINDRO DE RUEDA	370239	TRAS DER FRONTAL	30.1 mm 1-3/16"	DIESEL	382
		07-11	CILINDRO DE RUEDA	370240	TRAS DER POSTERIOR	30.1 mm 1-3/16"		382
		07-11	CILINDRO DE RUEDA	370247	TRAS IZQ POSTERIOR	30.1 mm 1-3/16"		382
		09-11	CILINDRO MAESTRO	39009916		34.9 mm 1-3/8"		361
		07-09	KIT DE PISTÓN Y REPUESTO FD	742405	DEL	57.1 mm 2-1/4"		
		07-11	REPUESTO FRENO DE DISCO	21016	DEL	57.1 mm 2-1/4"		546
ELF-450		06-08	CILINDRO MAESTRO	39009916		34.9 mm 1-3/8"		361
		07-09	KIT DE PISTÓN Y REPUESTO FD	742405	DEL	57.1 mm 2-1/4"	4 L DIESEL	
		07-09	REPUESTO FRENO DE DISCO	21016	DEL	57.1 mm 2-1/4"	4 L DIESEL	546
HOMBRE		96-00	CILINDRO DE RUEDA	37967	TRAS IZQ DER	13/16"		369
		98-00	MANGUERA DE FRENOS	38871	TRAS IZQ DER	18.88"	4X2	400
		98-00	MANGUERA DE FRENOS	38871	INT	18.88"	4X4	400
		98-00	MANGUERA DE FRENOS	380280	DEL IZQ DER	12.13"	4X2	411
		98-00	MANGUERA DE FRENOS	381032	IZQ	19.12"	4X4	431

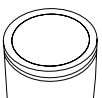

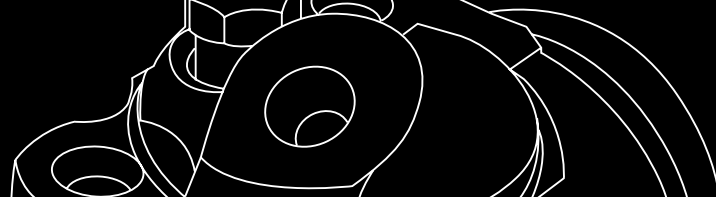

Modelo	Versión	Año	Descripción	Número Lusac	Posición	Diámetro	Notas	Foto Pág.	
HOMBRE		98-00	MANGUERA DE FRENOS	381033	DER	19.12"	4X4	431	
		98-00	MANGUERA DE FRENOS	381065	EXT	11.93"	4X4	433	
PICKUP ISUZU		88-95	CILINDRO DE CLUTCH	37833		22.2 mm 7/8"			
		91-94	CILINDRO DE CLUTCH	37834		22.2 mm 7/8"			
		88-95	CILINDRO DE CLUTCH	39804		15.8 mm 5/8"			
		93-95	CILINDRO MAESTRO	390161		23.8 mm 15/16"	CHOCOLATE	301	
		88-95	MANGUERA DE FRENOS	38679	DEL IZQ DER	18"		396	
RODEO		91-01	CILINDRO DE CLUTCH	37833		22.2 mm 7/8"			
		91-92	CILINDRO DE CLUTCH	37834		22.2 mm 7/8"			
		91-97	CILINDRO DE CLUTCH	39804		15.8 mm 5/8"			
		98-01	CILINDRO DE CLUTCH	350123		15.8 mm 5/8"	CHOCOLATE		
		93-01	CILINDRO DE CLUTCH	360033		22.2 mm 7/8"			
		00-04	CILINDRO DE RUEDA	37599	TRAS IZQ DER	7/8"		365	
		91-95	MANGUERA DE FRENOS	38679	DEL IZQ DER	18"	CHOCOLATE	396	
		96-97	MANGUERA DE FRENOS	380094	DEL	17.05"	CHOCOLATE	407	
		98-01	MANGUERA DE FRENOS	381096	DEL IZQ	16.31"			
	SPORT	01-03	CILINDRO DE RUEDA	37599	TRAS IZQ DER	7/8"		365	
TROOPER		88-91	CILINDRO DE CLUTCH	37833		22.2 mm 7/8"	CHOCOLATE		
		89-91	CILINDRO DE CLUTCH	37834		22.2 mm 7/8"	CHOCOLATE		
		92-97	CILINDRO DE CLUTCH	39804		15.8 mm 5/8"	CHOCOLATE		
		92-02	CILINDRO DE CLUTCH	360033		22.2 mm 7/8"	CHOCOLATE		
JAGUAR									
S	TYPE R	03-08	REPUESTO FRENO DE DISCO	2225	DEL	38.1 mm 1-1/2"		540	
S TYPE		01-08	REPUESTO FRENO DE DISCO	2225	DEL	38.1 mm 1-1/2"		540	
		00-05	CILINDRO MAESTRO	390555		1"	S/C DE ESTABILIDAD	318	
		00-02	MANGUERA DE FRENOS	381305	DER	18"		441	
X TYPE		02-08	MANGUERA DE FRENOS	382660	DEL DER	18.7"		480	
		02-08	MANGUERA DE FRENOS	382660	DEL IZQ	18.7"		480	
		02-08	REPUESTO FRENO DE DISCO	2225	DEL	38.1 mm 1-1/2"		540	
JEEP									
CHEROKEE	SPORT	94-94	CILINDRO DE RUEDA	37862	DER	13/16"		367	
	SPORT	98-01	CILINDRO DE RUEDA	37862	DER	13/16"		367	
	SPORT	94-94	CILINDRO DE RUEDA	37862	IZQ	13/16"		367	
	SPORT	98-01	CILINDRO DE RUEDA	37862	IZQ	13/16"		367	
	SPORT	94-94	CILINDRO MAESTRO	39981		15/16"	S/ABS	296	
	SPORT	98-01	CILINDRO MAESTRO	390303		1"	4X2	308	
	SPORT	94-94	MANGUERA DE FRENOS	38894	DEL DER	18.37"		401	
	SPORT	98-01	MANGUERA DE FRENOS	38894	DEL DER	18.37"		401	
	SPORT	94-94	MANGUERA DE FRENOS	38895	DEL IZQ	18.37"		401	
	SPORT	98-01	MANGUERA DE FRENOS	38895	DEL IZQ	18.37"		401	
	SPORT	94-94	MANGUERA DE FRENOS	380038	TRAS IZQ	15"		404	
	SPORT	98-01	MANGUERA DE FRENOS	380038	TRAS IZQ	15"		404	
	SPORT	94-94	PISTÓN FRENO DE DISCO	85392	DEL	66.0 mm		523	
	SPORT	98-01	PISTÓN FRENO DE DISCO	85392	DEL	66.0 mm		523	
	SPORT	98-01	REP. CIL. MAESTRO Y DE CLUTCH	90303		25.4 mm 1"		558	
	SPORT	94-94	REPUESTO FRENO DE DISCO	1473	DEL	66.0 mm		537	
	SPORT	98-01	REPUESTO FRENO DE DISCO	1473	DEL	66.0 mm		537	
			97-01	CILINDRO DE CLUTCH	350104		18.0 mm	NACIONAL	





Modelo	Versión	Año	Descripción	Número Lusac	Posición	Diámetro	Notas	Foto Pág.
JEEP								
CHEROKEE		92-92	CILINDRO DE CLUTCH	360089		Concentrico		
		91-93	CILINDRO DE RUEDA	17507	IZQ	7/8"		364
		95-97	CILINDRO DE RUEDA	17507	IZQ	7/8"		364
		91-93	CILINDRO DE RUEDA	17508	DER	7/8"		364
		95-97	CILINDRO DE RUEDA	17508	DER	7/8"		364
		97-97	CILINDRO DE RUEDA	37862	TRAS IZQ DER	13/16"		367
		95-97	CILINDRO MAESTRO	390303		1"		308
		94-94	KIT DE PISTÓN Y REPUESTO FD	742345	DEL	66.0 mm	CALIPER ATE	
		98-01	KIT DE PISTÓN Y REPUESTO FD	742345	DEL	66.0 mm	CALIPER ATE	
		90-91	MANGUERA DE FRENOS	38847	TRAS	14.38"		399
		91-93	MANGUERA DE FRENOS	38863	DEL DER	18.13"		399
		91-93	MANGUERA DE FRENOS	38864	DEL IZQ	18.13"		399
		95-97	MANGUERA DE FRENOS	38894	TRAS DER	18.37"		401
		95-97	MANGUERA DE FRENOS	38895	TRAS IZQ	18.37"		401
		92-93	MANGUERA DE FRENOS	380038	CTR	15"		404
		95-97	MANGUERA DE FRENOS	380038	CTR	15"		404
		93-93	REPUESTO CILINDRO DE RUEDA	101673		19.0 mm 3/4"		
	93-93	REPUESTO P/CILINDRO MAESTRO DE CLUTCH	730		22.2 mm 7/8"		556	
	93-93	REPUESTO P/CILINDRO MAESTRO DE CLUTCH	735		25.4 mm 1"		557	
CJ-5		78-78	KIT DE PISTÓN Y REPUESTO FD	742334	DEL	65.9 mm 2-19/32"		
COMANCHE		91-92	MANGUERA DE FRENOS	38863	DEL DER	18.13"	CHOCOLATE	399
		91-92	MANGUERA DE FRENOS	38864	DEL IZQ	18.13"	CHOCOLATE	399
COMMANDER		06-10	MANGUERA DE FRENOS	382570	DEL IZQ	20.5"		473
		06-10	MANGUERA DE FRENOS	382571	DEL DER	20.62"		473
		06-10	PISTÓN FRENO DE DISCO	850450	DEL Y TRAS	48.0 mm 1-57/64"		529
		06-10	PISTÓN FRENO DE DISCO	850460	DEL	47.6 mm 1-7/8"	CALIPER DOBLE PISTON	529
		06-10	REPUESTO FRENO DE DISCO	2045	DEL Y TRAS	48.0 mm 1-57/64"		539
		06-10	REPUESTO FRENO DE DISCO	20460	DEL	47.6 mm 1-7/8"	CALIPER DOBLE PISTON	545
	LIMITED PREMIUM, OVERLAND	06-10	CILINDRO MAESTRO	391001		1-1/16"		338
		06-10	KIT DE PISTÓN Y REPUESTO FD	742384	DEL	48.0 mm 1-57/64"		
COMPASS		07-14	PISTÓN FRENO DE DISCO	851330	DEL	57.1 mm 2-1/4"		534
		07-14	REPUESTO FRENO DE DISCO	21078	DEL	57.1 mm 2-1/4"		550
	SPORT, LIMITED PREMIUM	07-14	CILINDRO MAESTRO	391066		13/16"		341
		07-14	KIT DE PISTÓN Y REPUESTO FD	742399	DEL	57.1 mm 2-1/4"		
GRAND CHEROKEE		93-98	MANGUERA DE FRENOS	38894	DEL DER	18.37"		401
		93-98	MANGUERA DE FRENOS	38895	DEL IZQ	18.37"		401
		93-98	MANGUERA DE FRENOS	380189	TRAS DER	21.75"		407
		93-98	MANGUERA DE FRENOS	380189	TRAS IZQ	21.75"		407
		95-98	MANGUERA DE FRENOS	380225	TRAS DER	7.75"		409
		95-98	MANGUERA DE FRENOS	380226	TRAS IZQ	8.75"		409

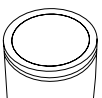

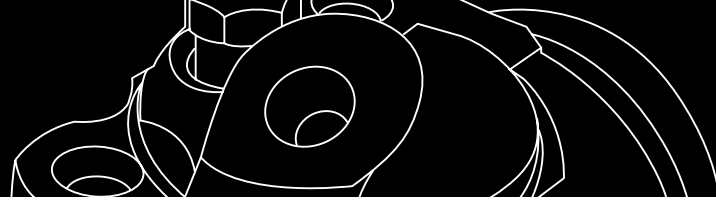

Modelo	Versión	Año	Descripción	Número Lusac	Posición	Diámetro	Notas	Foto Pág.	
GRAND CHEROKEE		99-05	MANGUERA DE FRENOS	381142	TRAS DER	8.1"		435	
		99-05	MANGUERA DE FRENOS	381143	TRAS IZQ	8.1"		435	
		99-05	MANGUERA DE FRENOS	382321	DEL DER	43"		456	
		99-05	MANGUERA DE FRENOS	382322	DEL IZQ	43"		456	
		06-10	MANGUERA DE FRENOS	382570	DEL IZQ	20.5"		473	
		06-10	MANGUERA DE FRENOS	382571	DEL DER	20.62"		473	
		06-10	MANGUERA DE FRENOS	382572	TRAS DER	19.12"		473	
		06-10	MANGUERA DE FRENOS	382573	TRAS IZQ	20.25"		473	
		93-98	PISTÓN FRENO DE DISCO	85392	DEL	66.0 mm		523	
		95-98	PISTÓN FRENO DE DISCO	85456	TRAS	48.0 mm 1-57/64"		524	
		99-10	PISTÓN FRENO DE DISCO	850450	DEL Y TRAS	48.0 mm 1-57/64"		529	
		99-10	PISTÓN FRENO DE DISCO	850460	DEL	47.6 mm 1-7/8"	CALIPER DOBLE PISTON	529	
		93-98	REPUESTO FRENO DE DISCO	1473	DEL	66.0 mm		537	
		99-10	REPUESTO FRENO DE DISCO	2045	DEL Y TRAS	48.0 mm 1-57/64"		539	
		95-98	REPUESTO FRENO DE DISCO	2477	TRAS	48.0 mm 1-57/64"		541	
		99-10	REPUESTO FRENO DE DISCO	20460	DEL	47.6 mm 1-7/8"	CALIPER DOBLE PISTON	545	
		SRT-8	06-10	CILINDRO MAESTRO	391001		1-1/16"		338
		SRT-8	06-10	MANGUERA DE FRENOS	382570	DEL IZQ	20.5"		473
		SRT-8	06-10	MANGUERA DE FRENOS	382571	DEL DER	20.62"		473
		SRT-8	06-10	MANGUERA DE FRENOS	382572	TRAS DER	19.12"		473
		SRT-8	06-10	MANGUERA DE FRENOS	382573	TRAS IZQ	20.25"		473
		SRT-8	06-10	PISTÓN FRENO DE DISCO	850450	DEL Y TRAS	48.0 mm 1-57/64"	CALIPER DOBLE PISTON	529
		SRT-8	06-10	PISTÓN FRENO DE DISCO	850460	DEL	47.6 mm 1-7/8"	CALIPER DOBLE PISTON	529
		SRT-8	06-10	REPUESTO FRENO DE DISCO	2045	DEL Y TRAS	48.0 mm 1-57/64"	CALIPER DOBLE PISTON	539
		SRT-8	06-10	REPUESTO FRENO DE DISCO	20460	DEL	47.6 mm 1-7/8"	CALIPER DOBLE PISTON	545
			93-98	CILINDRO DE RUEDA	17507	IZQ	7/8"		364
			93-98	CILINDRO DE RUEDA	17508	DER	7/8"		364
			93-94	CILINDRO MAESTRO	390071		1"	C/ABS	300
			95-98	CILINDRO MAESTRO	390303		1"		308
			06-10	CILINDRO MAESTRO	391001		1-1/16"		338
			05-05	CILINDRO MAESTRO	391020		1-1/16"	C/ DE TRACCIÓN PROGRAMA ELECTRONICA	339
			99-04	CILINDRO MAESTRO	5011260		25.4 mm 1"		359
			93-98	KIT DE PISTÓN Y REPUESTO FD	742345	DEL	66.0 mm	CALIPER ATE	
		95-98	KIT DE PISTÓN Y REPUESTO FD	742374	TRAS	48.0 mm 1-57/64"			
		99-10	KIT DE PISTÓN Y REPUESTO FD	742384	DEL	48.0 mm 1-57/64"			
		95-98	REP. CIL. MAESTRO Y DE CLUTCH	90303		25.4 mm 1"		558	
LIBERTY		02-08	MANGUERA DE FRENOS	382309	DEL IZQ	22.5"		455	
		02-08	MANGUERA DE FRENOS	382310	DEL DER	22.45"		455	
		02-13	PISTÓN FRENO DE DISCO	85153	DEL	66.0 mm		519	
		02-13	PISTÓN FRENO DE DISCO	85456	TRAS	48.0 mm 1-57/64"		524	





Modelo	Versión	Año	Descripción	Número Lusac	Posición	Diámetro	Notas	Foto Pág.
JEEP								
LIBERTY		02-13	REPUESTO FRENO DE DISCO	1473	DEL	66.0 mm		537
		02-13	REPUESTO FRENO DE DISCO	2477	TRAS	48.0 mm 1-57/64"		541
		02-02	CILINDRO DE RUEDA	370105	DER	13/16"		376
		02-02	CILINDRO DE RUEDA	370105	IZQ	13/16"		376
		02-06	CILINDRO MAESTRO	390712		1-1/16"		324
		06-07	CILINDRO MAESTRO	391012		26.9 mm 1-1/16"		339
		07-11	CILINDRO MAESTRO	391123		25.4 mm 1"		
		12-13	CILINDRO MAESTRO	391385		1-1/16"		357
		02-13	KIT DE PISTÓN Y REPUESTO FD	742373	DEL	66.0 mm		
		03-13	KIT DE PISTÓN Y REPUESTO FD	742374	TRAS	48.0 mm 1-57/64"		
		02-06	MANGUERA DE FRENOS	382311	TRAS CENTRAL	17.71"		455
	02-06	REP. CIL. MAESTRO Y DE CLUTCH	90711		26.9 mm 1-1/16"		560	
PATRIOT		07-14	PISTÓN FRENO DE DISCO	851330	DEL	57.1 mm 2-1/4"		534
		07-14	REPUESTO FRENO DE DISCO	21078	DEL	57.1 mm 2-1/4"		550
	SPORT, LIMITED	07-14	CILINDRO DE RUEDA	370197	IZQ	13/16"		381
	SPORT, LIMITED	07-14	CILINDRO MAESTRO	391066		13/16"		341
		07-14	KIT DE PISTÓN Y REPUESTO FD	742399	DEL	57.1 mm 2-1/4"		
WAGONEER		90-90	MANGUERA DE FRENOS	38847	TRAS	14.38"	CHOCOLATE	399
		93-93	REPUESTO P/CILINDRO MAESTRO DE CLUTCH	730		22.2 mm 7/8"		556
		93-93	REPUESTO P/CILINDRO MAESTRO DE CLUTCH	735		25.4 mm 1"		557
WRANGLER		93-95	MANGUERA DE FRENOS	38845	TRAS DER	17.31"		398
		93-96	MANGUERA DE FRENOS	38845	TRAS IZQ	17.31"		398
		93-96	MANGUERA DE FRENOS	38861	DEL DER	20.75"		399
		93-96	MANGUERA DE FRENOS	38862	DEL IZQ	20.75"		399
		97-06	MANGUERA DE FRENOS	38894	DEL DER	18.37"		401
		97-06	MANGUERA DE FRENOS	38895	DEL IZQ	18.37"		401
		96-96	MANGUERA DE FRENOS	380228	DEL DER	19 7/8"		409
		96-96	MANGUERA DE FRENOS	380229	DEL IZQ	21"		409
		03-06	MANGUERA DE FRENOS	380889	TRAS DER	17.85"		428
		96-06	MANGUERA DE FRENOS	380889	TRAS IZQ	17.85"		428
		07-10	PISTÓN FRENO DE DISCO	85153	DEL	66.0 mm		519
		93-06	PISTÓN FRENO DE DISCO	85392	DEL	66.0 mm		523
		03-06	PISTÓN FRENO DE DISCO	85456	TRAS	48.0 mm 1-57/64"		524
		93-06	REPUESTO FRENO DE DISCO	1473	DEL	66.0 mm		537
		03-06	REPUESTO FRENO DE DISCO	2477	TRAS	48.0 mm 1-57/64"		541
		07-10	REPUESTO FRENO DE DISCO	21998	DEL	66.0 mm		552
	SAHARA	97-99	CILINDRO DE RUEDA	37862	DER	13/16"		367
SAHARA	97-99	CILINDRO DE RUEDA	37862	IZQ	13/16"		367	
SAHARA	97-02	CILINDRO DE RUEDA	109532	DER	19.0 mm 3/4"		372	
SAHARA	97-02	CILINDRO DE RUEDA	109532	IZQ	19.0 mm 3/4"		372	

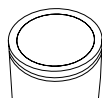



Modelo	Versión	Año	Descripción	Número Lusac	Posición	Diámetro	Notas	Foto Pág.
WRANGLER	SAHARA	97-02	CILINDRO MAESTRO	390378		1"		311
	SAHARA	07-14	CILINDRO MAESTRO	391385		1-1/16"		357
	UNLIMITED, RUBICON	03-06	CILINDRO DE RUEDA	109532	DER	19.0 mm 3/4"		372
	UNLIMITED, RUBICON	03-06	CILINDRO DE RUEDA	109532	IZQ	19.0 mm 3/4"		372
	UNLIMITED, RUBICON	03-06	CILINDRO MAESTRO	390378		1"		311
	UNLIMITED, RUBICON	07-14	CILINDRO MAESTRO	391385		1-1/16"		357
		97-01	CILINDRO DE CLUTCH	350104		18.0 mm	CHOCOLATE	
		92-92	CILINDRO DE CLUTCH	360089		Concentrico	CHOCOLATE	
		93-96	CILINDRO DE RUEDA	37862	DER	13/16"		367
		93-96	CILINDRO DE RUEDA	37862	IZQ	13/16"		367
		96-96	CILINDRO DE RUEDA	109532	DER	19.0 mm 3/4"		372
		96-96	CILINDRO DE RUEDA	109532	IZQ	19.0 mm 3/4"		372
		93-96	CILINDRO MAESTRO	39980		1"		296
		93-95	CILINDRO MAESTRO	390071		1"	C/ABS	300
		96-96	CILINDRO MAESTRO	390310		1"	4.0 LTS	
		07-14	CILINDRO MAESTRO	391068		25.4 mm 1"	DISCO (ROTOR) DE 11.89" DE DIÁMETRO	
		93-06	KIT DE PISTÓN Y REPUESTO FD	742345	DEL	66.0 mm	CALIPER ATE	
		03-06	KIT DE PISTÓN Y REPUESTO FD	742374	TRAS	48.0 mm 1-57/64"		
	07-10	KIT DE PISTÓN Y REPUESTO FD	742424	DEL	66.0 mm			
KIA								
SEPHIA		94-97	CILINDRO DE CLUTCH	37900		19.0 mm 3/4"	CHOCOLATE	
SPECTRA		01-04	CILINDRO DE RUEDA	37787	TRAS IZQ DER	11/16"	1.8 LTS	366
LAND ROVER								
DISCOVERY		00-04	MANGUERA DE FRENOS	382450	DEL DER	22.72"		465
		97-99	MANGUERA DE FRENOS	382670	DEL IZQ	10"		480
		97-99	MANGUERA DE FRENOS	382671	DEL DER	10"		480
LR2		08-13	MANGUERA DE FRENOS	382574	DEL DER	15.62"		473
		08-13	MANGUERA DE FRENOS	382574	DEL IZQ	15.62"		473
LINCOLN								
AVIATOR		03-05	MANGUERA DE FRENOS	382394	DEL IZQ	24"		463
		03-05	MANGUERA DE FRENOS	382395	DEL DER	24"		463
		03-05	MANGUERA DE FRENOS	382538	TRAS IZQ	20"		470
		03-05	PISTÓN FRENO DE DISCO	85456	TRAS	48.0 mm 1-57/64"		524
		03-05	PISTÓN FRENO DE DISCO	85491	TRAS	48.0 mm 1-57/64"		525
		03-05	REPUESTO FRENO DE DISCO	2477	TRAS	48.0 mm 1-57/64"		541
		03-05	CILINDRO MAESTRO	390398		1-1/16"		312
		03-05	CILINDRO MAESTRO	391045		1-1/16"		340
		03-05	KIT DE PISTÓN Y REPUESTO FD	742374	TRAS	48.0 mm 1-57/64"		
		03-05	REP. CIL. MAESTRO Y DE CLUTCH	90398		26.9 mm 1-1/16"		559
BLACKWOOD		03-03	KIT DE PISTÓN Y REPUESTO FD	742368	DEL	50.8 mm 2"	CON CALIPER DE DOBLE PISTON	
		03-03	MANGUERA DE FRENOS	380935	TRAS DER	21.78"		429
		03-03	MANGUERA DE FRENOS	380935	TRAS IZQ	21.78"		429
		03-03	MANGUERA DE FRENOS	381338	DEL DER	19.5"		442
	03-03	MANGUERA DE FRENOS	381338	DEL IZQ	19.5"		442	





Modelo	Versión	Año	Descripción	Número Lusac	Posición	Diámetro	Notas	Foto Pág.
LINCOLN								
BLACKWOOD		03-03	PISTÓN FRENO DE DISCO	85013	DEL	50.8 mm 2"	CALIPER DOBLE PISTON	518
		03-03	REPUESTO FRENO DE DISCO	2827	TRAS	50.8 mm 2"	CALIPER DOBLE PISTON	544
CONTINENTAL		97-97	MANGUERA DE FRENOS	380360	TRAS IZQ	15.25"		416
		97-99	MANGUERA DE FRENOS	380361	DEL DER	18.5"		416
		97-99	MANGUERA DE FRENOS	380362	DEL IZQ	18.5"		416
		98-99	MANGUERA DE FRENOS	380415	TRAS DER	15"		419
		98-99	MANGUERA DE FRENOS	380416	TRAS IZQ	15.5"		419
		97-97	MANGUERA DE FRENOS	381070	TRAS DER	16.5"		433
		97-99	PISTÓN FRENO DE DISCO	85438	DEL	65.9 mm 2-19/32"		524
		97-99	REPUESTO FRENO DE DISCO	2797	TRAS	54.0 mm 2-1/8"		543
		97-99	REPUESTO FRENO DE DISCO	83691	DEL	65.9 mm 2-19/32"		553
		97-99	KIT DE PISTÓN Y REPUESTO FD	742339	DEL	65.9 mm 2-19/32"		
LS		00-07	MANGUERA DE FRENOS	381303	TRAS IZQ	14.13"		441
		00-07	MANGUERA DE FRENOS	381305	DEL DER	18"		441
		00-07	REPUESTO FRENO DE DISCO	2225	DEL	38.1 mm 1-1/2"		540
		00-07	CILINDRO MAESTRO	390555		1"		318
MARK LT		06-07	MANGUERA DE FRENOS	382727	TRAS IZQ	11.62"		485
		06-08	CILINDRO MAESTRO	390811		1-1/8"		329
MARK VIII		94-96	MANGUERA DE FRENOS	38387	TRAS CTR	13.69"		391
		94-96	MANGUERA DE FRENOS	380193	TRAS DER	20"		408
		94-96	MANGUERA DE FRENOS	380194	TRAS IZQ	25.25"		408
		94-96	MANGUERA DE FRENOS	380378	DEL DER	16"		417
		94-96	MANGUERA DE FRENOS	380379	DEL IZQ	16"		417
		94-96	PISTÓN FRENO DE DISCO	85438	DEL	65.9 mm 2-19/32"		524
		94-96	REPUESTO FRENO DE DISCO	1967	TRAS	45.0 mm		538
		94-96	REPUESTO FRENO DE DISCO	83691	DEL	65.9 mm 2-19/32"		553
		94-96	CILINDRO MAESTRO	390126		1-1/16"		301
		94-96	KIT DE PISTÓN Y REPUESTO FD	742339	DEL	65.9 mm 2-19/32"		
MKZ		07-10	MANGUERA DE FRENOS	382575	DEL IZQ	25.62"		473
		07-08	MANGUERA DE FRENOS	382576	TRAS DER	11.62"		474
		07-08	MANGUERA DE FRENOS	382576	TRAS IZQ	11.62"		474
		07-08	CILINDRO MAESTRO	391069		13/16"		341
		09-10	CILINDRO MAESTRO	391134		13/16"		344
NAVIGATOR		01-02	MANGUERA DE FRENOS	380356	DEL DER	21.5"		416
		98-02	MANGUERA DE FRENOS	380554	DEL DER	21"		425
		98-00	MANGUERA DE FRENOS	380555	DEL IZQ	17.75"		425
		98-00	MANGUERA DE FRENOS	380556	DEL DER	43.25"		425
		98-02	MANGUERA DE FRENOS	380937	TRAS IZQ	19"		429
		98-02	MANGUERA DE FRENOS	380939	TRAS DER	20.98"		429
		98-02	MANGUERA DE FRENOS	381338	DEL IZQ	19.5"		442
		01-02	MANGUERA DE FRENOS	381365	DEL IZQ	18.85"		444
		03-06	MANGUERA DE FRENOS	382384	TRAS IZQ	21.5"		462
		03-06	MANGUERA DE FRENOS	382539	TRAS DER	19.5"		470
		03-06	MANGUERA DE FRENOS	382684	DEL IZQ	24.5"		481
		03-06	MANGUERA DE FRENOS	382685	DEL DER	24.5"		482
		03-06	PISTÓN FRENO DE DISCO	85810	DEL	54.0 mm 2-1/8"	CALIPER DOBLE PISTON	526

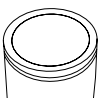



Modelo	Versión	Año	Descripción	Número Lusac	Posición	Diámetro	Notas	Foto Pág.
NAVIGATOR		98-02	PISTÓN FRENO DE DISCO	85826	DEL	50.8 mm 2"	CALIPER DOBLE PISTON	527
		98-02	PISTÓN FRENO DE DISCO	85827	TRAS	50.8 mm 2"		527
		03-06	PISTÓN FRENO DE DISCO	850790	TRAS	52.0 mm 2-3/64"		530
		03-06	REPUESTO FRENO DE DISCO	2079	TRAS	52.0 mm 2-3/64"		539
		03-06	REPUESTO FRENO DE DISCO	2810	DEL	54.0 mm 2-1/8"	CALIPER DOBLE PISTON	543
		98-02	REPUESTO FRENO DE DISCO	2826	DEL	50.8 mm 2"	CALIPER DOBLE PISTON	544
		98-02	REPUESTO FRENO DE DISCO	2827	TRAS	50.8 mm 2"		544
		98-02	CILINDRO MAESTRO	390336		1-1/4"	S/C DE VELOCIDAD, DISCO-DISCO 4X2	309
		98-02	CILINDRO MAESTRO	390337		1-1/4"	C/C DE VELOCIDAD, DISCO-DISCO 4X2	309
		03-06	CILINDRO MAESTRO	390762		1-1/8"		326
		98-02	KIT DE PISTÓN Y REPUESTO FD	742378	DEL	50.8 mm 2"	CON CALIPER DE DOBLE PISTON	
		98-02	KIT DE PISTÓN Y REPUESTO FD	742379	TRAS	50.8 mm 2"	CALIPER SENCILLO	
	98-02	REP. CIL. MAESTRO Y DE CLUTCH	90337		31.7 mm 1-1/4"		559	
TOWN CAR		95-96	MANGUERA DE FRENOS	38902	TRAS CTR	15.5"		402
		91-94	MANGUERA DE FRENOS	380041	DEL IZQ	11.75"		404
		91-94	MANGUERA DE FRENOS	380042	DEL DER	11.25"		404
		95-00	MANGUERA DE FRENOS	380296	DEL DER	11"		411
		95-00	MANGUERA DE FRENOS	380297	DEL IZQ	11"		411
		95-96	MANGUERA DE FRENOS	380380	TRAS DER	12.75"		417
		93-96	MANGUERA DE FRENOS	380381	TRAS IZQ	12.75"		418
		97-05	MANGUERA DE FRENOS	381071	TRAS IZQ	18"		433
		01-06	MANGUERA DE FRENOS	381072	TRAS DER	18"		433
		97-00	MANGUERA DE FRENOS	381073	TRAS DER	20.5"		433
		01-07	MANGUERA DE FRENOS	381141	DEL IZQ	11.15"		435
		91-00	PISTÓN FRENO DE DISCO	85424	TRAS	47.6 mm 1-7/8"		524
		95-00	PISTÓN FRENO DE DISCO	85438	DEL	65.9 mm 2-19/32"		524
		98-07	PISTÓN FRENO DE DISCO	85477	DEL	48.0 mm 1-57/64"	CALIPER DOBLE PISTON	525
		03-06	PISTÓN FRENO DE DISCO	85827	TRAS	50.8 mm 2"		527
		91-94	PISTÓN FRENO DE DISCO	98899	DEL	73.0 mm 2-7/8"		528
		95-00	REPUESTO FRENO DE DISCO	1837	DEL	65.9 mm 2-19/32"		538
		98-02	REPUESTO FRENO DE DISCO	2477	TRAS	48.0 mm 1-57/64"		541
		91-00	REPUESTO FRENO DE DISCO	2769	TRAS	47.6 mm 1-7/8"		543
		98-07	REPUESTO FRENO DE DISCO	2817	DEL	48.0 mm 1-57/64"	CALIPER DOBLE PISTON	544
	03-06	REPUESTO FRENO DE DISCO	2827	TRAS	50.8 mm 2"		544	
	91-94	REPUESTO FRENO DE DISCO	98948	DEL	73.0 mm 2-7/8"		553	
	81-02	CILINDRO DE RUEDA	101610	TRAS IZQ DER	23.8 mm 15/16"	EXECUTIVE	372	
	91-94	CILINDRO MAESTRO	390024		1"	C/ABS	299	
	95-96	CILINDRO MAESTRO	390245		1"	C/ABS	305	
	95-96	CILINDRO MAESTRO	390256		1"	S/ABS	305	

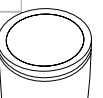



Modelo	Versión	Año	Descripción	Número Lusac	Posición	Diámetro	Notas	Foto Pág.
LINCOLN								
TOWN CAR		97-97	CILINDRO MAESTRO	390299		1"	C/ABS, S/C DE TRACCIÓN	307
		97-97	CILINDRO MAESTRO	390430		1"	C/ABS, C/C DE TRACCIÓN	313
		98-00	CILINDRO MAESTRO	390445		1"	C/ABS, S/C DE TRACCIÓN	314
		98-00	CILINDRO MAESTRO	390569		1"	C/ABS, C/C DE TRACCIÓN	319
		01-11	CILINDRO MAESTRO	390693		1"	C/ABS; S/C DE TRACCIÓN	323
		01-11	CILINDRO MAESTRO	390702		1"	CONTROL DE TRACCIÓN	323
		95-00	KIT DE PISTÓN Y REPUESTO FD	742339	DEL	65.9 mm 2-19/32"		
		95-00	KIT DE PISTÓN Y REPUESTO FD	742340	DEL	65.9 mm 2-19/32"	C/ABS	
		98-07	KIT DE PISTÓN Y REPUESTO FD	742376	DEL	48.0 mm 1-57/64"		
		03-06	KIT DE PISTÓN Y REPUESTO FD	742379	TRAS	50.8 mm 2"		
		98-05	MANGUERA DE FRENOS	381310	TRAS DER	13.07"		442
		98-05	MANGUERA DE FRENOS	381311	TRAS IZQ	13.07"		442
		08-11	MANGUERA DE FRENOS	382468	DER	20.5"		466
		08-11	MANGUERA DE FRENOS	382482	DER	20.25"	EXCEPTO LI-MOUSINE	467
		08-11	MANGUERA DE FRENOS	382483	IZQ	20.25"	EXCEPTO LI-MOUSINE	467
ZEPHYR		06-06	MANGUERA DE FRENOS	382575	DEL IZQ	25.62"		473
		06-06	MANGUERA DE FRENOS	382576	TRAS DER	11.62"		474
		06-06	MANGUERA DE FRENOS	382576	TRAS IZQ	11.62"		474
		06-06	CILINDRO MAESTRO	391069		13/16"		341
MAZDA								
626		88-02	CILINDRO DE RUEDA	37787	TRAS IZQ DER	11/16"		366
B2300		94-94	CILINDRO DE CLUTCH	350055		15.8 mm 5/8"		
		94-97	CILINDRO DE CLUTCH	360016		N/R		
		01-03	CILINDRO DE RUEDA	34876	TRAS IZQ DER	13/16"		364
		04-10	CILINDRO DE RUEDA	101604	TRAS IZQ DER	19.0 mm 3/4"		372
		01-10	CILINDRO DE RUEDA	370061	TRAS IZQ DER	13/16"		375
		01-10	CILINDRO MAESTRO	390398		1-1/16"	FRENOS DE PODER; C/C CRUCERO	312
		01-01	CILINDRO MAESTRO	390399		1-1/16"	S/C CRUCERO; HASTA 7/01	312
		01-08	CILINDRO MAESTRO	390696		1-1/16"	S/C CRUCERO	323
		01-10	MANGUERA DE FRENOS	38813	CTR	19.9"		397
		95-97	MANGUERA DE FRENOS	380389	DEL DER	22.75"		418
		97-97	MANGUERA DE FRENOS	380938	DEL IZQ	14.62"	CHOCOLATE	429
		01-10	MANGUERA DE FRENOS	381134	IZQ	16.35"		435
	06-10	MANGUERA DE FRENOS	381157	DER	11"		436	
B2500		98-99	CILINDRO DE CLUTCH	360016		N/R		
		98-01	CILINDRO DE RUEDA	34876	TRAS IZQ DER	13/16"		364
		98-01	CILINDRO DE RUEDA	370061	TRAS IZQ DER	13/16"		375
		98-01	CILINDRO MAESTRO	390398		1-1/16"	C/C CRUCERO	312
		98-01	CILINDRO MAESTRO	390399		1-1/16"	S/C CRUCERO	312
	98-01	MANGUERA DE FRENOS	38813	CTR	19.9"		397	

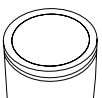

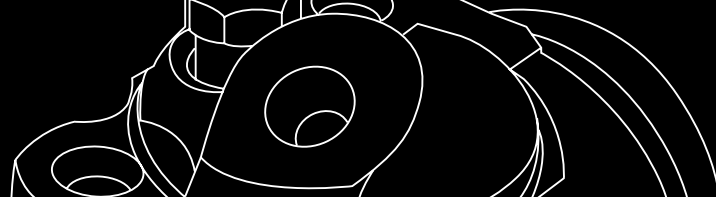

Modelo	Versión	Año	Descripción	Número Lusac	Posición	Diámetro	Notas	Foto Pág.
B2500		00-01	MANGUERA DE FRENOS	381134	IZQ	16.35"		435
B3000		94-94	CILINDRO DE CLUTCH	350055		15.8 mm 5/8"		
B3000		94-99	CILINDRO DE CLUTCH	360016		N/R		
		98-03	CILINDRO DE RUEDA	34876	TRAS IZQ DER	13/16"		364
		04-08	CILINDRO DE RUEDA	101604	TRAS IZQ DER	19.0 mm 3/4"		372
		98-08	CILINDRO DE RUEDA	370061	TRAS IZQ DER	13/16"		375
		01-08	CILINDRO MAESTRO	390398		1-1/16"	FRENOS DE PODER; C/C CRUCERO	312
		98-01	CILINDRO MAESTRO	390399		1-1/16"	S/C CRUCERO	312
		98-00	CILINDRO MAESTRO	390400		1-1/16"	C/C CRUCERO	312
		02-08	CILINDRO MAESTRO	390696		1-1/16"	S/C CRUCERO	323
		94-08	MANGUERA DE FRENOS	38813	CTR	19.9"		397
		95-97	MANGUERA DE FRENOS	380389	DEL DER	22.75"		418
		00-08	MANGUERA DE FRENOS	381134	IZQ	16.35"		435
		98-08	MANGUERA DE FRENOS	381157	DER	11"		436
		00-02	MANGUERA DE FRENOS	381158	IZQ	11"		436
	B4000		94-94	CILINDRO DE CLUTCH	350055		15.8 mm 5/8"	
		94-99	CILINDRO DE CLUTCH	360016		N/R		
		95-97	MANGUERA DE FRENOS	380389	DEL DER	22.75"	CHOCOLATE	418
CX-7		07-12	MANGUERA DE FRENOS	382579	DEL DER	18.88"		474
		07-12	MANGUERA DE FRENOS	382579	DEL IZQ	18.88"		474
CX-9		07-14	MANGUERA DE FRENOS	382579	DEL DER	18.88"		474
		07-14	MANGUERA DE FRENOS	382579	DEL IZQ	18.88"		474
MAZDA2		12-14	CILINDRO DE RUEDA	37866	TRAS DER	3/4"		368
		12-14	CILINDRO DE RUEDA	37866	TRAS IZQ	19.0 mm 3/4"		368
		12-14	KIT DE PISTÓN Y REPUESTO FD	742387	DEL	54.0 mm 2-1/8"		
MAZDA3		06-14	PISTÓN FRENO DE DISCO	851015	DEL	57.1 mm 2-1/4"		531
		06-14	REPUESTO FRENO DE DISCO	21015	DEL	57.1 mm 2-1/4"		546
		06-14	REPUESTO FRENO DE DISCO	21995	TRAS	54.0 mm 2-1/8"		552
		06-14	CILINDRO MAESTRO	391049		1"		341
		06-14	KIT DE PISTÓN Y REPUESTO FD	742400	DEL	57.1 mm 2-1/4"		
MAZDA5		06-12	KIT DE PISTÓN Y REPUESTO FD	742400	DEL	57.1 mm 2-1/4"		
		06-14	PISTÓN FRENO DE DISCO	851015	DEL	57.1 mm 2-1/4"		531
		06-14	REPUESTO FRENO DE DISCO	21015	DEL	57.1 mm 2-1/4"		546
		06-14	REPUESTO FRENO DE DISCO	21995	TRAS	54.0 mm 2-1/8"		552
		06-08	MANGUERA DE FRENOS	382575	DEL IZQ	25.62"		473
		06-08	MANGUERA DE FRENOS	382576	TRAS DER	11.62"		474
		06-08	MANGUERA DE FRENOS	382576	TRAS IZQ	11.62"		474
		06-08	CILINDRO MAESTRO	391069		13/16"		341
		06-08	CILINDRO MAESTRO	391129		13/16"		343
		06-10	KIT DE PISTÓN Y REPUESTO FD	742420	DEL	57.1 mm 2-1/4"		
		03-05	MANGUERA DE FRENOS	382575	IZQ	25.62"		473
NAVAJO		91-92	CILINDRO DE CLUTCH	39904		19.0 mm 3/4"	CHOCOLATE	
		91-91	CILINDRO DE CLUTCH	350041		19.0 mm 3/4"	CHOCOLATE	





Modelo	Versión	Año	Descripción	Número Lusac	Posición	Diámetro	Notas	Foto Pág.
MAZDA								
NAVAJO		93-94	CILINDRO DE CLUTCH	350055		15.8 mm 5/8"	CHOCOLATE	
		93-94	CILINDRO DE CLUTCH	360016		N/R	CHOCOLATE	
PROTEGE		90-95	CILINDRO DE CLUTCH	37900		19.0 mm 3/4"	CHOCOLATE	
		99-03	CILINDRO DE RUEDA	37787	TRAS IZQ DER	11/16"		366
TRIBUTE		08-08	CILINDRO MAESTRO	391202		26.9 mm 1-1/16"	FABRICADO EN USA	
MERCEDES BENZ								
C220		95-95	MANGUERA DE FRENOS	38514	TRAS IZQ	11.94"		392
C230	4MATIC	09-09	MANGUERA DE FRENOS	382586	DEL IZQ DER	17.12"		474
	KOMPRES-SOR	02-05	CILINDRO MAESTRO	390765		15/16" & 13/16"		327
		97-99	CILINDRO MAESTRO	390488		15/16"		315
		06-09	MANGUERA DE FRENOS	381658	DEL IZQ DER	16.38"		453
		06-07	MANGUERA DE FRENOS	382583	TRAS IZQ DER	12.12"		474
		09-09	MANGUERA DE FRENOS	382586	DEL IZQ DER	17.12"		474
C230 K		96-00	CILINDRO MAESTRO	390488		15/16"		315
C240		01-02	CILINDRO MAESTRO	390765		15/16" & 13/16"	C/ABS	327
C280		98-00	MANGUERA DE FRENOS	38514	TRAS IZQ	11.94"		392
	VAGONETA	98-99	CILINDRO MAESTRO	390488		15/16"		315
	VAGONETA	98-99	MANGUERA DE FRENOS	38514	TRAS IZQ	11.94"		392
		95-00	CILINDRO MAESTRO	390488		15/16"		315
C300	4MATIC	08-14	MANGUERA DE FRENOS	382586	DEL IZQ DER	17.12"		474
		08-11	MANGUERA DE FRENOS	381658	DEL DER	16.38"		453
		10-11	MANGUERA DE FRENOS	381658	DEL IZQ	16.38"		453
		08-11	MANGUERA DE FRENOS	382586	TRAS DER	17.12"		474
		10-11	MANGUERA DE FRENOS	382586	TRAS IZQ	17.12"		474
C350		06-14	MANGUERA DE FRENOS	381658	DEL DER	16.38"		453
		06-14	MANGUERA DE FRENOS	381658	DEL IZQ	16.38"		453
		06-07	MANGUERA DE FRENOS	382583	TRAS DER	12.12"		474
		06-07	MANGUERA DE FRENOS	382583	TRAS IZQ	12.12"		474
		08-14	MANGUERA DE FRENOS	382586	TRAS DER	17.12"		474
		08-14	MANGUERA DE FRENOS	382586	TRAS IZQ	17.12"		474
C43		98-00	MANGUERA DE FRENOS	38514	TRAS IZQ	11.94"		392
C55		05-07	MANGUERA DE FRENOS	382583	TRAS DER	12.12"		474
		05-07	MANGUERA DE FRENOS	382583	TRAS IZQ	12.12"		474
		03-05	MANGUERA DE FRENOS	382584	DEL DER	15.16"		474
		03-05	MANGUERA DE FRENOS	382584	DEL IZQ	15.16"		474
		03-07	CILINDRO MAESTRO	390698		13/16"		323
C55AMG		05-07	MANGUERA DE FRENOS	381658	DEL IZQ DER	16.38"		453
		05-07	MANGUERA DE FRENOS	382583	TRAS IZQ DER	12.12"		474
C63AMG	BASE COUPE <204.377>	08-11	MANGUERA DE FRENOS	382586	DEL IZQ DER	17.12"		474
CL500		01-06	MANGUERA DE FRENOS	382584	DEL DER	15.16"		474
		01-06	MANGUERA DE FRENOS	382584	DEL IZQ	15.16"		474
		07-09	MANGUERA DE FRENOS	382585	DEL DER	17"		474
		07-09	MANGUERA DE FRENOS	382585	DEL IZQ	17"		474
		99-06	CILINDRO MAESTRO	390698		13/16"		323
		00-00	MANGUERA DE FRENOS	382584	DEL IZQ DER	15.16"		474
CL600		03-06	MANGUERA DE FRENOS	382584	DEL DER	15.16"		474
		03-06	MANGUERA DE FRENOS	382584	DEL IZQ	15.16"		474
		07-13	MANGUERA DE FRENOS	382585	DEL DER	17"		474
		07-13	MANGUERA DE FRENOS	382585	DEL IZQ	17"		474
		99-06	CILINDRO MAESTRO	390698		13/16"		323

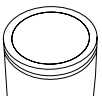



Modelo	Versión	Año	Descripción	Número Lusac	Posición	Diámetro	Notas	Foto Pág.
CLK320		98-05	MANGUERA DE FRENOS	381658	DEL DER	16.38"		453
		98-05	MANGUERA DE FRENOS	381658	DEL IZQ	16.38"		453
		98-05	MANGUERA DE FRENOS	382583	TRAS DER	12.12"		474
		98-05	MANGUERA DE FRENOS	382583	TRAS IZQ	12.12"		474
		98-03	CILINDRO MAESTRO	390624		15/16" & 3/4"		320
CLK350		06-09	MANGUERA DE FRENOS	381658	DEL DER	16.38"		453
		06-09	MANGUERA DE FRENOS	381658	DEL IZQ	16.38"		453
		06-09	MANGUERA DE FRENOS	382583	TRAS DER	12.12"		474
		06-09	MANGUERA DE FRENOS	382583	TRAS IZQ	12.12"		474
CLK500		03-06	MANGUERA DE FRENOS	381658	DEL DER	16.38"		453
		03-06	MANGUERA DE FRENOS	381658	DEL IZQ	16.38"		453
		03-06	MANGUERA DE FRENOS	382583	TRAS DER	12.12"		474
		03-06	MANGUERA DE FRENOS	382583	TRAS IZQ	12.12"		474
CLK55AMG		04-05	MANGUERA DE FRENOS	381658	DEL DER	16.38"		453
		04-05	MANGUERA DE FRENOS	381658	DEL IZQ	16.38"		453
		04-05	MANGUERA DE FRENOS	382583	TRAS DER	12.12"		474
		04-05	MANGUERA DE FRENOS	382583	TRAS IZQ	12.12"		474
		01-06	MANGUERA DE FRENOS	381658	DEL IZQ DER	16.38"		453
		01-06	MANGUERA DE FRENOS	382583	TRAS IZQ DER	12.12"		474
CLK63AMG		08-09	MANGUERA DE FRENOS	381658	DEL DER	16.38"		453
		08-09	MANGUERA DE FRENOS	381658	DEL IZQ	16.38"		453
		08-09	MANGUERA DE FRENOS	382583	TRAS DER	12.12"		474
		08-09	MANGUERA DE FRENOS	382583	TRAS IZQ	12.12"		474
E280		07-09	CILINDRO MAESTRO	390465		1-3/4"		315
		07-09	CILINDRO MAESTRO	390491		1" & 3/4"		315
E320		96-05	CILINDRO MAESTRO	390465		1-3/4"		315
		96-05	CILINDRO MAESTRO	390618		1" & 3/4"		320
E350		10-14	MANGUERA DE FRENOS	381658	DEL DER	16.38"	2 PTAS CON- VERTIBLE	453
		10-13	MANGUERA DE FRENOS	381658	DEL IZQ	16.38"		453
	CONVERTIBLE	10-13	MANGUERA DE FRENOS	382586	TRAS DER	17.12"		474
	COUPE	10-13	MANGUERA DE FRENOS	382586	TRAS IZQ	17.12"		474
E400		93-93	CILINDRO MAESTRO	39704		3/4" & 1"		
E420		93-97	CILINDRO MAESTRO	39704		3/4" & 1"		
E430		99-02	MANGUERA DE FRENOS	380009	DEL DER	14.5"		404
		99-02	MANGUERA DE FRENOS	380009	DEL IZQ	14.5"		404
		99-02	CILINDRO MAESTRO	390618		1" & 3/4"		320
E63AMG		10-14	MANGUERA DE FRENOS	382585	DEL DER	17"		474
		10-14	MANGUERA DE FRENOS	382585	DEL IZQ	17"		474
G55AMG		09-12	MANGUERA DE FRENOS	380009	DEL DER	14.5"		404
		09-12	MANGUERA DE FRENOS	380009	DEL IZQ	14.5"		404
GLK350		09-14	MANGUERA DE FRENOS	382586	TRAS DER	17.12"		474
		09-14	MANGUERA DE FRENOS	382586	TRAS IZQ	17.12"		474
S350	BLUETEC 4MATIC	12-13	MANGUERA DE FRENOS	382585	DEL IZQ DER	17"		474
		06-06	CILINDRO MAESTRO	390698		13/16"		323
S350L		11-13	MANGUERA DE FRENOS	382585	DEL DER	17"		474
		11-13	MANGUERA DE FRENOS	382585	DEL IZQ	17"		474
S430		00-05	CILINDRO MAESTRO	390698		13/16"		323
S500L		93-93	MANGUERA DE FRENOS	38514	TRAS IZQ	11.94"		392
		93-94	MANGUERA DE FRENOS	380009	DEL DER	14.5"		404
		93-94	MANGUERA DE FRENOS	380009	DEL IZQ	14.5"		404
		03-06	CILINDRO MAESTRO	390698		13/16"		323
S55AMG		01-06	CILINDRO MAESTRO	390698		13/16"		323
S55L		03-05	CILINDRO MAESTRO	390698		13/16"		323

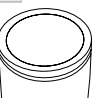



Modelo	Versión	Año	Descripción	Número Lusac	Posición	Diámetro	Notas	Foto Pág.
MERCEDES BENZ								
S600L		07-13	MANGUERA DE FRENOS	382585	DEL DER	17"		474
		07-13	MANGUERA DE FRENOS	382585	DEL IZQ	17"		474
		02-02	CILINDRO MAESTRO	390698		13/16"		323
SL320		95-97	MANGUERA DE FRENOS	380009	DEL DER	14.5"		404
		95-97	MANGUERA DE FRENOS	380009	DEL IZQ	14.5"		404
		95-97	CILINDRO MAESTRO	390491		1" & 3/4"		315
SL500		95-02	MANGUERA DE FRENOS	380009	DEL DER	14.5"		404
		95-02	MANGUERA DE FRENOS	380009	DEL IZQ	14.5"		404
		03-06	MANGUERA DE FRENOS	382586	TRAS DER	17.12"		474
		03-06	MANGUERA DE FRENOS	382586	TRAS IZQ	17.12"		474
SL55AMG		95-97	CILINDRO MAESTRO	390491		1" & 3/4"		315
		03-08	MANGUERA DE FRENOS	382586	TRAS DER	17.12"		474
		03-08	MANGUERA DE FRENOS	382586	TRAS IZQ	17.12"		474
SL600		95-02	MANGUERA DE FRENOS	380009	DEL DER	14.5"		404
		95-02	MANGUERA DE FRENOS	380009	DEL IZQ	14.5"		404
		04-10	MANGUERA DE FRENOS	382586	TRAS DER	17.12"		474
		04-10	MANGUERA DE FRENOS	382586	TRAS IZQ	17.12"		474
SL63AMG		09-12	MANGUERA DE FRENOS	382586	TRAS DER	17.12"		474
		09-12	MANGUERA DE FRENOS	382586	TRAS IZQ	17.12"		474
SL65AMG		05-11	MANGUERA DE FRENOS	382586	TRAS DER	17.12"		474
		06-11	MANGUERA DE FRENOS	382586	TRAS IZQ	17.12"		474
SLK230		97-05	CILINDRO MAESTRO	390488		15/16"		315
		97-05	CILINDRO MAESTRO	390624		15/16" & 3/4"		320
SLK320		01-05	CILINDRO MAESTRO	390624		15/16" & 3/4"		320
SLK350		05-14	MANGUERA DE FRENOS	381658	DEL DER	16.38"		453
		05-14	MANGUERA DE FRENOS	381658	DEL IZQ	16.38"		453
		05-11	MANGUERA DE FRENOS	382583	TRAS DER	12.12"		474
		05-11	MANGUERA DE FRENOS	382583	TRAS IZQ	12.12"		474
SLK55		08-14	MANGUERA DE FRENOS	381658	DEL DER	16.38"		453
		08-14	MANGUERA DE FRENOS	381658	DEL IZQ	16.38"		453
		08-10	MANGUERA DE FRENOS	382583	TRAS DER	12.12"		474
		08-10	MANGUERA DE FRENOS	382583	TRAS IZQ	12.12"		474
		08-10	CILINDRO MAESTRO	390766		1" & 13/16"		327
SLK55AMG		05-10	CILINDRO MAESTRO	390766		1" & 13/16"		327
		05-14	MANGUERA DE FRENOS	381658	DEL IZQ DER	16.38"		453
		05-10	MANGUERA DE FRENOS	382583	TRAS IZQ DER	12.12"		474
SPRINTER		04-06	PISTÓN FRENO DE DISCO	851053	DEL	48.0 mm 1-57/64"		533
		04-06	REPUESTO FRENO DE DISCO	21049	DEL	48.0 mm 1-57/64"		549
		04-06	REPUESTO FRENO DE DISCO	21053	TRAS	48.0 mm 1-57/64"		549
	311	12-14	MANGUERA DE FRENOS	382586	DEL DER	17.12"		474
	311	12-14	MANGUERA DE FRENOS	382586	DEL IZQ	17.12"		474
	311	12-14	MANGUERA DE FRENOS	382586	TRAS DER	17.12"		474
	311	12-14	MANGUERA DE FRENOS	382586	TRAS IZQ	17.12"		474
	311	12-14	MANGUERA DE FRENOS	382622	TRAS DER	19"		477
	311	12-14	MANGUERA DE FRENOS	382622	TRAS IZQ	19"		477
	315 CHASIS CABINA CDI	07-09	CILINDRO MAESTRO	390979		1-1/16"		337
315 CHASIS CABINA CDI	12-14	MANGUERA DE FRENOS	382586	DEL DER	17.12"		474	
315 CHASIS CABINA CDI	12-14	MANGUERA DE FRENOS	382586	DEL IZQ	17.12"		474	

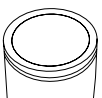



Modelo	Versión	Año	Descripción	Número Lusac	Posición	Diámetro	Notas	Foto Pág.
SPRINTER	315 CHASIS CABINA CDI	12-14	MANGUERA DE FRENOS	382586	TRAS DER	17.12"		474
	315 CHASIS CABINA CDI	12-14	MANGUERA DE FRENOS	382586	TRAS IZQ	17.12"		474
	315 CHASIS CABINA CDI	07-11	MANGUERA DE FRENOS	382622	DEL DER	19"		477
	315 CHASIS CABINA CDI	07-11	MANGUERA DE FRENOS	382622	DEL IZQ	19"		477
	315 CHASIS CABINA CDI	07-11	MANGUERA DE FRENOS	382622	TRAS DER	19"		477
	315 CHASIS CABINA CDI	07-11	MANGUERA DE FRENOS	382622	TRAS IZQ	19"		477
	315 CHASIS CABINA CDI	07-11	PISTÓN FRENO DE DISCO	851053	DEL	48.0 mm 1-57/64"		533
	315 CHASIS CABINA CDI	07-11	REPUESTO FRENO DE DISCO	21049	DEL	48.0 mm 1-57/64"		549
	315 CHASIS CABINA CDI	07-09	REPUESTO FRENO DE DISCO	21053	TRAS	48.0 mm 1-57/64"		549
	415 CHASIS CABINA CDI	04-09	CILINDRO MAESTRO	390979		1-1/16"		337
	415 CHASIS CABINA CDI	10-14	MANGUERA DE FRENOS	382586	DEL DER	17.12"		474
	415 CHASIS CABINA CDI	10-14	MANGUERA DE FRENOS	382586	DEL IZQ	17.12"		474
	415 CHASIS CABINA CDI	10-14	MANGUERA DE FRENOS	382586	TRAS DER	17.12"		474
	415 CHASIS CABINA CDI	10-14	MANGUERA DE FRENOS	382586	TRAS IZQ	17.12"		474
	415 CHASIS CABINA CDI	07-09	MANGUERA DE FRENOS	382622	DEL DER	19"		477
	415 CHASIS CABINA CDI	07-09	MANGUERA DE FRENOS	382622	DEL IZQ	19"		477
	415 CHASIS CABINA CDI	07-09	MANGUERA DE FRENOS	382622	TRAS DER	19"		477
	415 CHASIS CABINA CDI	07-09	MANGUERA DE FRENOS	382622	TRAS IZQ	19"		477
	415 CHASIS CABINA CDI	07-11	PISTÓN FRENO DE DISCO	851053	DEL	48.0 mm 1-57/64"		533
	415 CHASIS CABINA CDI	07-11	REPUESTO FRENO DE DISCO	21049	DEL	48.0 mm 1-57/64"		549
	415 CHASIS CABINA CDI	07-09	REPUESTO FRENO DE DISCO	21053	TRAS	48.0 mm 1-57/64"		549
	515 CREW CAB CHASIS CABINA CD	07-09	CILINDRO MAESTRO	390979		1-1/16"		337
	515 CREW CAB CHASIS CABINA CD	07-09	MANGUERA DE FRENOS	382622	DEL DER	19"		477
	515 CREW CAB CHASIS CABINA CD	07-09	MANGUERA DE FRENOS	382622	DEL IZQ	19"		477
	515 CREW CAB CHASIS CABINA CD	07-09	MANGUERA DE FRENOS	382622	TRAS DER	19"		477
	515 CREW CAB CHASIS CABINA CD	07-09	MANGUERA DE FRENOS	382622	TRAS IZQ	19"		477
		04-06	CILINDRO MAESTRO	390980		25.4 mm 1"		337
		04-11	CILINDRO MAESTRO	390988		26.9 mm 1-1/16"	AUTOMÁTICA	338
		04-11	KIT DE PISTÓN Y REPUESTO FD	742435	DEL	48.0 mm 1-57/64"		
		04-09	KIT DE PISTÓN Y REPUESTO FD	742436	DEL	48.0 mm 1-57/64"		





Modelo	Versión	Año	Descripción	Número Lusac	Posición	Diámetro	Notas	Foto Pág.
MERCURY								
MARINER		05-07	MANGUERA DE FRENOS	382387	TRAS DER	18.13"		462
		05-07	MANGUERA DE FRENOS	382388	TRAS IZQ	18.25"		462
		05-07	MANGUERA DE FRENOS	382460	DEL IZQ	11 9/16"		466
		05-07	MANGUERA DE FRENOS	382460	TRAS IZQ	11 9/16"		466
		05-07	MANGUERA DE FRENOS	382462	DEL DER	17.38"		466
		05-07	MANGUERA DE FRENOS	382462	DEL IZQ	17.38"		466
		08-11	MANGUERA DE FRENOS	382544	TRAS DER	10.62"		471
		08-11	MANGUERA DE FRENOS	382545	TRAS IZQ	11.56"		471
		05-09	PISTÓN FRENO DE DISCO	85800	DEL	60.0 mm		526
		05-09	REPUESTO FRENO DE DISCO	2844	DEL	60.0 mm		544
		05-09	CILINDRO DE RUEDA	370094	DER	15/16"		376
		05-09	CILINDRO DE RUEDA	370094	IZQ	15/16"		376
		10-11	CILINDRO DE RUEDA	370211	DER	15/16"		381
		10-11	CILINDRO DE RUEDA	370211	IZQ	15/16"		381
		05-07	CILINDRO MAESTRO	390909		1-1/16"		334
		05-07	CILINDRO MAESTRO	390910		1"		334
		07-09	CILINDRO MAESTRO	391202		26.9 mm 1-1/16"	CON TRANSEJE AUTOMÁTICO	
	08-11	CILINDRO MAESTRO	391203		1-1/16"		349	
	07-08	MANGUERA DE FRENOS	382582	TRAS IZQ	18.25"		474	
MILAN		07-08	MANGUERA DE FRENOS	382575	DEL IZQ	25.62"		473
		07-08	MANGUERA DE FRENOS	382576	TRAS DER	11.62"		474
		07-08	MANGUERA DE FRENOS	382576	TRAS IZQ	11.62"		474
		06-09	CILINDRO MAESTRO	391069		13/16"		341
		06-06	CILINDRO MAESTRO	391129		13/16"	S/ABS	343
		09-09	CILINDRO MAESTRO	391134		13/16"	INTERACTIVE VEHICLE DYNAMICS	344
		06-06	MANGUERA DE FRENOS	382575	IZQ	25.62"		473
		09-09	MANGUERA DE FRENOS	382575	IZQ	25.62"		473
		06-06	MANGUERA DE FRENOS	382576	TRAS IZQ DER	11.62"		474
		09-09	MANGUERA DE FRENOS	382576	TRAS IZQ DER	11.62"	FWD HASTA 11/11/08	474
SABLE		94-95	MANGUERA DE FRENOS	38382	DEL IZQ	16.69"		391
		94-95	MANGUERA DE FRENOS	38607	TRAS IZQ	19.56"		393
		94-95	MANGUERA DE FRENOS	38608	TRAS DER	19.44"		393
		94-95	MANGUERA DE FRENOS	38681	DEL DER	15.75"		396
		96-04	MANGUERA DE FRENOS	380415	TRAS DER	15"		419
		96-04	MANGUERA DE FRENOS	380416	TRAS IZQ	15.5"	DS DEL 96 AL 05 TAMBIÉN PUEDE LLEVAR LAS MANGUERAS 380417 TRAS DER Y 380418 TRAS IZQ	419
		96-04	MANGUERA DE FRENOS	380419	DEL DER	22.5"		419
		94-04	PISTÓN FRENO DE DISCO	85438	DEL	65.9 mm 2-19/32"		524
		94-04	REPUESTO FRENO DE DISCO	2797	TRAS	54.0 mm 2-1/8"		543
		94-04	REPUESTO FRENO DE DISCO	83691	DEL	65.9 mm 2-19/32"		553
	VAGONETA	94-95	CILINDRO DE RUEDA	37857	IZQ	1"		367
	VAGONETA	94-95	CILINDRO MAESTRO	122572		25.4 mm 1"		299
	VAGONETA	94-95	CILINDRO MAESTRO	390024		1"	C/ABS	299
VAGONETA	96-97	CILINDRO MAESTRO	390370		1"		311	

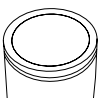



Modelo	Versión	Año	Descripción	Número Lusac	Posición	Diámetro	Notas	Foto Pág.
SABLE	VAGONETA	94-97	MANGUERA DE FRENOS	38382	DEL IZQ	16.69"		391
	VAGONETA	94-95	MANGUERA DE FRENOS	38607	TRAS IZQ	19.56"		393
	VAGONETA	94-95	MANGUERA DE FRENOS	38608	TRAS DER	19.44"		393
	VAGONETA	94-95	MANGUERA DE FRENOS	38666	TRAS IZQ	12.75"		396
	VAGONETA	94-95	MANGUERA DE FRENOS	38669	TRAS DER	11.5"		396
	VAGONETA	94-97	MANGUERA DE FRENOS	38681	DEL DER	15.75"		396
	VAGONETA	94-95	MANGUERA DE FRENOS	38961	TRAS DER	13.88"		403
	VAGONETA	94-97	PISTÓN FRENO DE DISCO	85438	DEL	65.9 mm 2-19/32"		524
	VAGONETA	94-95	REP. CIL. MAESTRO Y DE CLUTCH	120797		25.4 mm 1"		562
	VAGONETA	94-97	REPUESTO FRENO DE DISCO	2797	TRAS	54.0 mm 2-1/8"		543
	VAGONETA	94-97	REPUESTO FRENO DE DISCO	83691	DEL	65.9 mm 2-19/32"		553
		93-06	CILINDRO DE RUEDA	37857	IZQ	1"		367
		96-96	CILINDRO MAESTRO	390298		1"	V6, 3.0 LTS	307
		97-05	CILINDRO MAESTRO	390370		1"	S/C DE TRACCIÓN	311
		00-04	CILINDRO MAESTRO	390608		1"	C/C DE TRACCIÓN V6	320
		03-05	CILINDRO MAESTRO	390812		1"		329
		94-05	KIT DE PISTÓN Y REPUESTO FD	742339	DEL	65.9 mm 2-19/32"		
		05-05	MANGUERA DE FRENOS	380415	DER	15"	DISCO-DISCO	419
		05-05	MANGUERA DE FRENOS	380416	IZQ	15.5"	DISCO-DISCO	419
		05-05	MANGUERA DE FRENOS	380417	DER	15.5"	DISCO-TAMBOR	419
	05-05	MANGUERA DE FRENOS	380418	IZQ	15.5"	DISCO-TAMBOR	419	
	05-05	MANGUERA DE FRENOS	380419	DER	22.5"		419	
TRACER		91-96	CILINDRO DE CLUTCH	37900		19.0 mm 3/4"	CHOCOLATE	
VILLAGER		93-00	CILINDRO MAESTRO	390115		1"	C/ABS	300
		99-00	CILINDRO MAESTRO	390584		1"	S/ABS	319
		93-02	MANGUERA DE FRENOS	380103	DEL IZQ DER	21.25"		407
		00-02	MANGUERA DE FRENOS	381377	TRAS	14.05"		445
MINI COOPER								
COOPER		02-13	MANGUERA DE FRENOS	382669	DEL DER	23.25"		480
		02-13	MANGUERA DE FRENOS	382669	DEL IZQ	23.25"		480
		02-06	PISTÓN FRENO DE DISCO	85813	DEL	48.0 mm 1-57/64"		526
		02-06	REPUESTO FRENO DE DISCO	2813	DEL	48.0 mm 1-57/64"		543
	S	02-08	CILINDRO MAESTRO	391321		7/8"		355
	S	02-13	MANGUERA DE FRENOS	382669	DEL DER	23.25"		480
	S	02-13	MANGUERA DE FRENOS	382669	DEL IZQ	23.25"		480
		02-08	CILINDRO MAESTRO	391321		7/8"		355
MITSUBISHI								
ECLIPSE	GT	03-05	CILINDRO MAESTRO	390661		1-1/16"	S/ABS	322
	GT	10-12	CILINDRO MAESTRO	391321		7/8"		355
	GT	03-05	CILINDRO MAESTRO	475431		26.9 mm 1-1/16"	C/ABS	358
	GT	03-05	CILINDRO MAESTRO	475973		26.9 mm 1-1/16"	S/ABS, S/C DE TRACCIÓN	358
	GT	03-05	MANGUERA DE FRENOS	38328	TRAS DER	10.5"		390
	GT	03-05	MANGUERA DE FRENOS	38328	TRAS IZQ	10.5"		390
	GT	03-05	MANGUERA DE FRENOS	380545	DEL DER	22.25"		425
	GT	03-05	MANGUERA DE FRENOS	380545	DEL IZQ	22.25"		425
	GT	06-12	MANGUERA DE FRENOS	382646	TRAS IZQ	17.5"		479
	GT	06-12	MANGUERA DE FRENOS	382647	TRAS DER	17.5"		479
	GT	06-12	PISTÓN FRENO DE DISCO	851055	DEL	60.3 mm 2-3/8"		533





Modelo	Versión	Año	Descripción	Número Lusac	Posición	Diámetro	Notas	Foto Pág.
MITSUBISHI								
ECLIPSE	GT	06-12	PISTÓN FRENO DE DISCO	851470	TRAS	34.9 mm 1-3/8"		534
	GT	06-12	REPUESTO FRENO DE DISCO	642	DEL	60.3 mm 2-3/8"		536
		95-99	CILINDRO DE CLUTCH	350087		15.8 mm 5/8"	CHOCOLATE	
		01-02	CILINDRO DE CLUTCH	519868		15.8 mm 5/8"	CHOCOLATE	
		96-05	CILINDRO DE RUEDA	37376	TRAS IZQ DER	3/4"		365
		01-02	CILINDRO MAESTRO	390660		1-1/16"	C/ABS	322
		01-02	CILINDRO MAESTRO	390661		1-1/16"	S/ABS	322
		06-09	KIT DE PISTÓN Y REPUESTO FD	742347	DEL	60.3 mm 2-3/8"		
	95-02	MANGUERA DE FRENOS	38328	TRAS IZQ DER	10.5"		DISCO-DISCO	390
ENDEAVOR	LIMITED	04-11	CILINDRO MAESTRO	390886		1"	C/ABS	333
	LIMITED	04-11	REPUESTO FRENO DE DISCO	21041	DEL	45.5 mm		548
		04-08	CILINDRO MAESTRO	391222		1"	S/C DE TRACCIÓN	350
		04-11	KIT DE PISTÓN Y REPUESTO FD	742304	DEL	63.5 mm 2-1/2"		
GALANT		03-03	MANGUERA DE FRENOS	38328	TRAS DER	10.5"		390
		03-03	MANGUERA DE FRENOS	38328	TRAS IZQ	10.5"		390
		04-06	MANGUERA DE FRENOS	382646	TRAS IZQ	17.5"		479
		09-09	MANGUERA DE FRENOS	382646	TRAS IZQ	17.5"		479
		04-06	MANGUERA DE FRENOS	382647	TRAS DER	17.5"		479
		09-09	MANGUERA DE FRENOS	382647	TRAS DER	17.5"		479
		03-06	PISTÓN FRENO DE DISCO	851055	DEL	60.3 mm 2-3/8"		533
		09-09	PISTÓN FRENO DE DISCO	851055	DEL	60.3 mm 2-3/8"		533
		03-06	REPUESTO FRENO DE DISCO	642	DEL	60.3 mm 2-3/8"		536
		09-09	REPUESTO FRENO DE DISCO	642	DEL	60.3 mm 2-3/8"		536
	DE	94-03	CILINDRO DE RUEDA	37376	TRAS IZQ DER	3/4"		365
	DE	99-02	CILINDRO MAESTRO	390660		1-1/16"	4 CIL C/ABS	322
	DE	00-02	CILINDRO MAESTRO	390660		1-1/16"	V6 CIL S/C TRACCIÓN	322
	DE	99-02	CILINDRO MAESTRO	390661		1-1/16"	4 CIL S/ABS	322
	DE	99-02	MANGUERA DE FRENOS	38328	TRAS IZQ DER	10.5"	V6 CIL	390
	DE	10-12	MANGUERA DE FRENOS	382646	IZQ	17.5"		479
	DE	10-12	MANGUERA DE FRENOS	382647	DER	17.5"		479
	ES	04-05	CILINDRO MAESTRO	390897		1"	S/ABS	333
	ES	07-09	MANGUERA DE FRENOS	382646	TRAS IZQ	17.5"		479
	ES	07-09	MANGUERA DE FRENOS	382647	TRAS DER	17.5"		479
	ES	07-09	PISTÓN FRENO DE DISCO	851055	DEL	60.3 mm 2-3/8"		533
	ES	07-09	REPUESTO FRENO DE DISCO	642	DEL	60.3 mm 2-3/8"		536
	GTS	05-09	MANGUERA DE FRENOS	382646	TRAS IZQ	17.5"		479
	GTS	05-09	MANGUERA DE FRENOS	382647	TRAS DER	17.5"		479
	GTS	05-09	PISTÓN FRENO DE DISCO	851055	DEL	60.3 mm 2-3/8"		533
	GTS	05-09	REPUESTO FRENO DE DISCO	642	DEL	60.3 mm 2-3/8"		536
INC ES, GTS, RALLIART	07-08	MANGUERA DE FRENOS	382646	TRAS IZQ	17.5"		479	

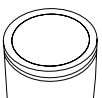

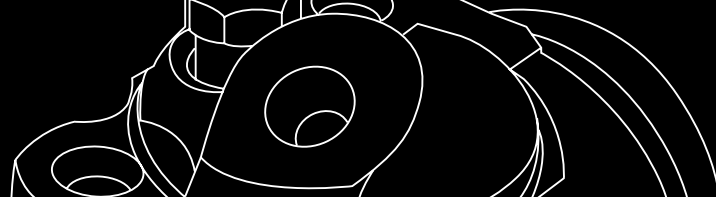

Modelo	Versión	Año	Descripción	Número Lusac	Posición	Diámetro	Notas	Foto Pág.
GALANT	INC ES, GTS, RALLIART	07-08	MANGUERA DE FRENOS	382647	TRAS DER	17.5"		479
	INC ES, GTS, RALLIART	07-08	PISTÓN FRENO DE DISCO	851055	DEL	60.3 mm 2-3/8"		533
	INC ES, GTS, RALLIART	07-08	REPUESTO FRENO DE DISCO	642	DEL	60.3 mm 2-3/8"		536
	RALLIART	07-08	MANGUERA DE FRENOS	382646	TRAS IZQ	17.5"		479
	RALLIART	07-08	MANGUERA DE FRENOS	382647	TRAS DER	17.5"		479
	RALLIART	07-08	PISTÓN FRENO DE DISCO	851055	DEL	60.3 mm 2-3/8"		533
	RALLIART	07-08	REPUESTO FRENO DE DISCO	642	DEL	60.3 mm 2-3/8"		536
		89-93	CILINDRO DE RUEDA	37969	TRAS IZQ DER	19.0 mm 3/4"		369
		03-03	CILINDRO MAESTRO	390661		1-1/16"	S/ABS	322
		04-09	CILINDRO MAESTRO	391014		25.4 mm 1"	3.8 6 V OHC	
L200		03-03	CILINDRO MAESTRO	475431		26.9 mm 1-1/16"	C/ABS	358
		03-03	CILINDRO MAESTRO	475973		26.9 mm 1-1/16"	S/ABS	358
LANCER		07-11	CILINDRO DE RUEDA	3700924	DER	22.23 mm 7/8		
		07-11	CILINDRO DE RUEDA	3700925	IZQ	22.23 mm 7/8		
		04-10	MANGUERA DE FRENOS	381501	TRAS DER	11.25"		447
		04-10	MANGUERA DE FRENOS	381501	TRAS IZQ	11.25"		447
		04-10	PISTÓN FRENO DE DISCO	85209	DEL	54.0 mm 2-1/8"		521
		04-10	REPUESTO FRENO DE DISCO	643	DEL	54.0 mm 2-1/8"		536
	DE ABS, ES	08-09	PISTÓN FRENO DE DISCO	85209	DEL	54.0 mm 2-1/8"		521
	DE ABS, ES	08-09	PISTÓN FRENO DE DISCO	851470	TRAS	34.9 mm 1-3/8"		534
	DE ABS, ES	08-09	REPUESTO FRENO DE DISCO	643	DEL	54.0 mm 2-1/8"		536
	EVOLUTION IX	06-06	PISTÓN FRENO DE DISCO	851470	TRAS	34.9 mm 1-3/8"		534
	RALLIART	05-06	CILINDRO MAESTRO	390760		7/8"	S/ABS	326
	RALLIART	05-06	PISTÓN FRENO DE DISCO	85209	DEL	54.0 mm 2-1/8"		521
	RALLIART	05-06	PISTÓN FRENO DE DISCO	851470	TRAS	34.9 mm 1-3/8"		534
	RALLIART	05-06	REPUESTO FRENO DE DISCO	643	DEL	54.0 mm 2-1/8"		536
		04-05	CILINDRO DE RUEDA	370155	DER	3/4"		379
		04-10	CILINDRO DE RUEDA	370155	IZQ	3/4"		379
		04-06	CILINDRO MAESTRO	390759		22.2 mm 7/8"	AUTOMÁTICO S/ABS	326
		04-05	CILINDRO MAESTRO	390760		7/8"	S/ABS	326
		04-04	CILINDRO MAESTRO	390874		1"	C/ABS	333
		04-07	CILINDRO MAESTRO	391013		22.2 mm 7/8"		339
	06-10	KIT DE PISTÓN Y REPUESTO FD	742307	DEL	57.1 mm 2-1/4"	5 BIRLOS		
	06-10	KIT DE PISTÓN Y REPUESTO FD	742399	DEL	57.1 mm 2-1/4"			
	04-09	KIT DE PISTÓN Y REPUESTO FD	742416	DEL	54.0 mm 2-1/8"	C/ABS		
MIRAGE		93-98	CILINDRO DE RUEDA	37969	TRAS IZQ DER	19.0 mm 3/4"	CHOCOLATE	369
MONTERO		92-00	CILINDRO MAESTRO	390156		23.8 mm 15/16"	S/ABS CHOCOLATE	301
		03-09	KIT DE PISTÓN Y REPUESTO FD	742301	DEL	42.8 mm 1-11/16"	CON CALIPER DE DOBLE PISTON	
		92-00	MANGUERA DE FRENOS	36824	EXT	8.88"		387
	SPORT	99-04	CILINDRO DE RUEDA	37708	IZQ	7/8"		366
	SPORT	99-04	CILINDRO DE RUEDA	37709	DER	7/8"		366

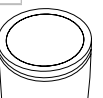



Modelo	Versión	Año	Descripción	Número Lusac	Posición	Diámetro	Notas	Foto Pág.
MITSUBISHI								
MONTERO	SPORT	93-03	CILINDRO MAESTRO	390156		23.8 mm 15/16"		301
	SPORT	00-04	CILINDRO MAESTRO	390654		1"	3.5 LTS C/ABS	321
	SPORT	00-03	CILINDRO MAESTRO	390655		1"	3.0 LTS.	321
	SPORT	00-04	CILINDRO MAESTRO	390655		1"	3.5 LTS.	321
	SPORT	97-04	MANGUERA DE FRENOS	36824	EXT	8.88"	DISCO-DISCO	387
OUTLANDER		04-08	MANGUERA DE FRENOS	381501	TRAS DER	11.25"		447
		04-08	MANGUERA DE FRENOS	381501	TRAS IZQ	11.25"		447
		04-10	PISTÓN FRENO DE DISCO	85476	TRAS	38.1 mm 1-1/2"		525
		07-10	PISTÓN FRENO DE DISCO	851007	DEL	42.8mm 1 11/16		530
		04-06	PISTÓN FRENO DE DISCO	851055	DEL	60.3 mm 2-3/8"		533
		04-06	REPUESTO FRENO DE DISCO	642	DEL	60.3 mm 2-3/8"		536
		04-10	REPUESTO FRENO DE DISCO	2476	TRAS	38.1 mm 1-1/2"		
		07-10	REPUESTO FRENO DE DISCO	21007	DEL	42.8 mm 1-11/16"		546
		03-06	CILINDRO DE RUEDA	370129	DER	13/16"		377
		04-06	CILINDRO DE RUEDA	370129	IZQ	13/16"		377
		09-10	CILINDRO MAESTRO	390781		1"		328
		03-08	CILINDRO MAESTRO	390781		1"	C/ABS	328
		07-10	KIT DE PISTÓN Y REPUESTO FD	742301	DEL	42.8 mm 1-11/16"	CON CALIPER DE DOBLE PISTON	
		04-06	KIT DE PISTÓN Y REPUESTO FD	742347	DEL	60.3 mm 2-3/8"		
		04-10	KIT DE PISTÓN Y REPUESTO FD	742396	TRAS	38.1 mm 1-1/2"	2.4 4 L	
		04-06	KIT DE PISTÓN Y REPUESTO FD	742417	DEL	60.3 mm 2-3/8"		
		03-03	MANGUERA DE FRENOS	381501	TRAS IZQ DER	11.25"		447
NISSAN								
240 SX		93-93	MANGUERA DE FRENOS	38697	DEL DER	21.75"		397
		98-98	MANGUERA DE FRENOS	381060	DEL DER	20.32"		432
		93-93	PISTÓN FRENO DE DISCO	85472	DEL	57.1 mm 2-1/4"		525
		98-98	PISTÓN FRENO DE DISCO	85472	DEL	57.1 mm 2-1/4"		525
		93-93	REPUESTO FRENO DE DISCO	1458	DEL	57.1 mm 2-1/4"		537
		98-98	REPUESTO FRENO DE DISCO	1458	DEL	57.1 mm 2-1/4"		537
		93-93	REPUESTO FRENO DE DISCO	2027	TRAS	34.0 mm		
		95-98	CILINDRO DE CLUTCH	350082		15.8 mm 5/8"	CHOCOLATE	
		93-93	CILINDRO MAESTRO	39810		7/8"	S/ABS	295
		98-98	CILINDRO MAESTRO	39810		7/8"	S/ABS	295
300ZX		93-98	KIT DE PISTÓN Y REPUESTO FD	742398	DEL	57.1 mm 2-1/4"		
		91-92	MANGUERA DE FRENOS	38688	DEL DER	23.38"		396
		96-96	MANGUERA DE FRENOS	38688	DEL DER	23.38"		396
		91-92	MANGUERA DE FRENOS	38688	DEL IZQ	23.38"		396
		96-96	MANGUERA DE FRENOS	38688	DEL IZQ	23.38"		396
		91-92	REPUESTO FRENO DE DISCO	2022R	TRAS	38.1 mm 1-1/2"		554
	96-96	REPUESTO FRENO DE DISCO	2022R	TRAS	38.1 mm 1-1/2"		554	

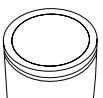



Modelo	Versión	Año	Descripción	Número Lusac	Posición	Diámetro	Notas	Foto Pág.
300ZX		91-92	REPUESTO FRENO DE DISCO	2024R	DEL	40.5 mm 1-19/32"	CALIPER DOBLE PISTON	555
		96-96	REPUESTO FRENO DE DISCO	2024R	DEL	40.5 mm 1-19/32"	CALIPER DOBLE PISTON	555
	INCLUYE CONVERTIBLE	93-95	CILINDRO MAESTRO	390038		1"		299
	INCLUYE CONVERTIBLE	93-95	MANGUERA DE FRENOS	38688	DEL DER	23.38"		396
	INCLUYE CONVERTIBLE	93-95	MANGUERA DE FRENOS	38688	DEL IZQ	23.38"		396
	INCLUYE CONVERTIBLE	93-95	REPUESTO FRENO DE DISCO	2022R	TRAS	38.1 mm 1-1/2"		554
	INCLUYE CONVERTIBLE	93-95	REPUESTO FRENO DE DISCO	2024R	DEL	40.5 mm 1-19/32"	CALIPER DOBLE PISTON	555
		84-96	CILINDRO DE CLUTCH	37627		19.0 mm 3/4"		
		91-92	CILINDRO MAESTRO	390038		1"		299
		96-96	CILINDRO MAESTRO	390038		1"		299
350Z		03-08	MANGUERA DE FRENOS	381650	TRAS DER	13.25"		452
		03-08	MANGUERA DE FRENOS	381651	TRAS IZQ	13.25"		452
ALMERA	COMFORT	01-05	PISTÓN FRENO DE DISCO	85218	DEL	57.1 mm 2-1/4"		522
	COMFORT	01-05	REPUESTO FRENO DE DISCO	1458	DEL	57.1 mm 2-1/4"		537
	COMFORT	01-05	REPUESTO FRENO DE DISCO	21640	TRAS	38.1 mm 1-1/2"		551
ALTIMA		96-97	MANGUERA DE FRENOS	380223	TRAS DER	13"		409
		00-01	MANGUERA DE FRENOS	380223	TRAS DER	13"		409
		96-97	MANGUERA DE FRENOS	380223	TRAS IZQ	13"		409
		00-01	MANGUERA DE FRENOS	380223	TRAS IZQ	13"		409
		96-01	MANGUERA DE FRENOS	380224	TRAS DER	19.88"		409
		96-01	MANGUERA DE FRENOS	380224	TRAS IZQ	19.88"		409
		96-01	MANGUERA DE FRENOS	380489	DEL IZQ	18.25"		422
		96-00	MANGUERA DE FRENOS	380490	DEL IZQ	18.25"		423
		96-01	MANGUERA DE FRENOS	380517	DEL DER	19.75"		423
		96-01	MANGUERA DE FRENOS	380517	DEL IZQ	19.75"		423
		02-07	MANGUERA DE FRENOS	381594	DEL DER	20.5"		450
		96-12	PISTÓN FRENO DE DISCO	85472	DEL	57.1 mm 2-1/4"		525
		02-12	PISTÓN FRENO DE DISCO	851470	TRAS	34.9 mm 1-3/8"		534
		96-12	REPUESTO FRENO DE DISCO	1458	DEL	57.1 mm 2-1/4"		537
		96-01	REPUESTO FRENO DE DISCO	2027	TRAS	34.0 mm		
		02-12	REPUESTO FRENO DE DISCO	21470	TRAS	34.9 mm 1-3/8"		551
	2.5	93-95	MANGUERA DE FRENOS	380517	DEL IZQ DER	19.75"		423
	SEDAN S, SEDAN SL, SEDAN SE	02-07	CILINDRO MAESTRO	390007		3/4"	C/ABS	299
		05-06	CILINDRO DE CLUTCH	360139		17.4 mm 11/16"		
		01-02	CILINDRO DE CLUTCH	306108J1		15.8 mm 5/8"		
		96-00	CILINDRO DE RUEDA	37693	DER	3/4"		366
		96-00	CILINDRO DE RUEDA	37693	IZQ	3/4"		366
	96-01	CILINDRO DE RUEDA	370106	DER	15/16"		376	
	96-01	CILINDRO DE RUEDA	370106	IZQ	15/16"		376	





Modelo	Versión	Año	Descripción	Número Lusac	Posición	Diámetro	Notas	Foto Pág.
NISSAN								
ALTIMA		01-01	CILINDRO MAESTRO	390007		3/4"	C/ABS	299
		96-00	CILINDRO MAESTRO	390139		15/16"	S/ABS	301
		96-00	CILINDRO MAESTRO	390140		15/16"	SE S/ABS, TOKIKO	301
		96-00	CILINDRO MAESTRO	390451		1"	TOKIKO C/ABS	314
		07-09	CILINDRO MAESTRO	391308		23.8 mm 15/16"	SEDAN 2.5 4 L DOHC AUTOMÁTICA	
		07-10	CILINDRO MAESTRO	391309		23.8 mm 15/16"	2.5	
		07-14	CILINDRO MAESTRO	391310		23.8 mm 15/16"	SEDAN 3.5 6 V DOHC AUTOMÁTICA	354
		07-14	CILINDRO MAESTRO	391311		23.8 mm 15/16"	SEDAN 3.5 6 V DOHC MANUAL	
		07-11	CILINDRO MAESTRO	391330		3/4"		355
		02-10	KIT DE PISTÓN Y REPUESTO FD	742395	TRAS	34.9 mm 1-3/8"		
	96-12	KIT DE PISTÓN Y REPUESTO FD	742398	DEL	57.1 mm 2-1/4"			
APRIO		08-10	KIT DE PISTÓN Y REPUESTO FD	742423	DEL	48.0 mm 1-5/7/64"		
		08-10	PISTÓN FRENO DE DISCO	85215	DEL	48.0 mm 1-5/7/64"		522
		08-10	REPUESTO FRENO DE DISCO	2215	DEL	48.0 mm 1-5/7/64"		540
ARMADA		04-10	MANGUERA DE FRENOS	382564	DEL IZQ	18.88"		472
		04-10	MANGUERA DE FRENOS	382565	DEL DER	18.88"		473
		04-13	MANGUERA DE FRENOS	382567	TRAS DER	15"		473
		04-13	CILINDRO MAESTRO	391072		1-3/16"	4X4	341
CABSTAR		08-12	KIT DE PISTÓN Y REPUESTO FD	742434	DEL	52.0 mm 2-3/64"		
		08-12	KIT DE PISTÓN Y REPUESTO FD	742435	DEL	48.0 mm 1-5/7/64"		
		85-13	PISTÓN FRENO DE DISCO	851048	DEL	52.0mm 2-3/64"		532
		85-13	PISTÓN FRENO DE DISCO	851053	DEL	48.0 mm 1-5/7/64"		533
		85-13	REPUESTO FRENO DE DISCO	21048	DEL	52.0mm 2-3/64"	CALIPER BREMBO	549
		85-13	REPUESTO FRENO DE DISCO	21049	DEL	48.0 mm 1-5/7/64"		549
DATSUN SEDAN		70-83	CILINDRO DE CLUTCH	6600		19.0 mm 3/4"	CIL ESCLAVO DE CLUTCH	
FRONTIER		01-01	MANGUERA DE FRENOS	381108	TRAS IZQ	21.13"		434
		01-04	MANGUERA DE FRENOS	381120	DEL DER	15.48"		434
		01-01	MANGUERA DE FRENOS	381121	DEL IZQ	15.48"		434
		03-03	MANGUERA DE FRENOS	381653	TRAS DER	20.25"		453
		02-04	MANGUERA DE FRENOS	382302	DEL IZQ	18"		454
		02-04	MANGUERA DE FRENOS	382674	DEL IZQ	16.75"		480
		02-04	MANGUERA DE FRENOS	382675	DEL DER	16.75"		480
		02-04	MANGUERA DE FRENOS	382675	DEL IZQ	16.75"	DS 2.4 LTS	480
		01-04	PISTÓN FRENO DE DISCO	85177	DEL	42.8 mm 1-11/16"	CALIPER DOBLE PISTON	521
		01-04	PISTÓN FRENO DE DISCO	85216	DEL	44.4 mm 1-3/4"	CALIPER DOBLE PISTON	522
		01-04	REPUESTO FRENO DE DISCO	1668	DEL	42.8 mm 1-11/16"	CALIPER DOBLE PISTON	537
		01-04	REPUESTO FRENO DE DISCO	2216	DEL	44.4 mm 1-3/4"	CALIPER DOBLE PISTON	540
		98-98	CILINDRO DE CLUTCH	37627		19.0 mm 3/4"		
		98-01	CILINDRO DE CLUTCH	306109Z4		15.8 mm 5/8"	4 L	
	99-01	CILINDRO DE CLUTCH	306109Z4		15.8 mm 5/8"	6		

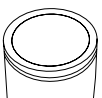



Modelo	Versión	Año	Descripción	Número Lusac	Posición	Diámetro	Notas	Foto Pág.
FRONTIER		98-00	CILINDRO DE RUEDA	37871	TRAS IZQ DER	13/16"	4X4	368
		98-02	CILINDRO DE RUEDA	370158	DER	7/8"		379
		01-02	CILINDRO DE RUEDA	370158	IZQ	7/8"		379
		03-04	CILINDRO DE RUEDA	441007Z0	IZQ	7/8"		
		03-04	CILINDRO DE RUEDA	441007Z8	DER	22.2 mm 7/8"		
		99-02	CILINDRO MAESTRO	390441		1"	2.4 LTS 4X2	314
		01-02	CILINDRO MAESTRO	390838		1"	3.3 LTS	331
		03-04	CILINDRO MAESTRO	390839		25.4 mm 1"	6 V 4X4 AUTOMÁTICA	331
		03-04	CILINDRO MAESTRO	390867		1"	4X2	332
		01-01	CILINDRO MAESTRO	390994		25.4 mm 1"	4X4	338
		99-00	CILINDRO MAESTRO	390995		1"	2.4 LTS 4X4 PICKUP (2 PTAS)	338
		05-11	CILINDRO MAESTRO	390996		1"	SE, XE 4X2, AUT	338
		05-11	CILINDRO MAESTRO	391008		1"	SE S/C DE TRACCIÓN; ESTÁNDAR	339
		08-11	CILINDRO MAESTRO	391096		1"	SE AUT	342
		08-11	CILINDRO MAESTRO	391097		1"	V6, AUTOMÁTICO	342
		01-02	CILINDRO MAESTRO	460107B7		25.4 mm 1"		362
		00-04	KIT DE PISTÓN Y REPUESTO FD	742327	DEL	42.8 mm 1-11/16"	4 L	
		98-00	MANGUERA DE FRENOS	381108	CTR	21.13"	4X4	434
	INFINITI	05-05	MANGUERA DE FRENOS	381650	TRAS DER	13.25"		452
	INFINITI	05-05	MANGUERA DE FRENOS	381651	TRAS IZQ	13.25"		452
HIKARI		88-92	MANGUERA DE FRENOS	380223	TRAS DER	13"		409
		88-92	MANGUERA DE FRENOS	380223	TRAS IZQ	13"		409
		88-92	MANGUERA DE FRENOS	380224	DEL DER	19.88"		409
		88-92	MANGUERA DE FRENOS	380224	DEL IZQ	19.88"		409
		88-92	MANGUERA DE FRENOS	380517	DEL DER	19.75"		423
		88-92	MANGUERA DE FRENOS	380517	DEL IZQ	19.75"		423
		88-92	PISTÓN FRENO DE DISCO	6000	DEL	48.0 mm 1-57/64"		518
		88-92	REPUESTO FRENO DE DISCO	641	DEL	48.0 mm 1-57/64"		536
		88-92	CILINDRO DE RUEDA	117345	DER	19.0 mm 3/4"		374
		88-92	CILINDRO DE RUEDA	117345	IZQ	19.0 mm 3/4"		374
		88-92	CILINDRO MAESTRO	39406		3/4" & 15/16"	CIL NABCO	294
		88-92	CILINDRO MAESTRO	39555		3/4" & 15/16"	CIL TOKICO	294
		88-92	KIT DE PISTÓN Y REPUESTO FD	742331	DEL	48.0 mm 1-57/64"		
		88-92	REP. CIL. MAESTRO Y DE CLUTCH	681		19.0 mm 3/4"		
		88-92	REP. CIL. MAESTRO Y DE CLUTCH	688		19.0 mm 3/4"		
	SAMURAI	84-87	MANGUERA DE FRENOS	1204	TRAS IZQ	11 11/16"		
	SAMURAI	84-87	MANGUERA DE FRENOS	4055	DEL DER	22 1/4"		
	SAMURAI	84-87	MANGUERA DE FRENOS	4055	DEL IZQ	22 1/4"		
	SAMURAI	84-87	PISTÓN FRENO DE DISCO	6000	DEL	48.0 mm 1-57/64"		518
	SAMURAI	84-87	REPUESTO FRENO DE DISCO	641	DEL	48.0 mm 1-57/64"		536
	SAMURAI	84-87	CILINDRO DE RUEDA	37407	DER	13/16"		365
	SAMURAI	84-87	CILINDRO DE RUEDA	37407	IZQ	13/16"		365
	SAMURAI	84-87	CILINDRO MAESTRO	39406		3/4" & 15/16"	CIL TOKICO	294
SAMURAI	84-87	REP. CIL. MAESTRO Y DE CLUTCH	688		19.0 mm 3/4"			
I-30	INFINITI	98-99	CILINDRO MAESTRO	390233		15/16"		304
	INFINITI	00-01	CILINDRO MAESTRO	390639		15/16"		321

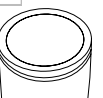



Modelo	Versión	Año	Descripción	Número Lusac	Posición	Diámetro	Notas	Foto Pág.
NISSAN								
I-30	INFINITI	98-01	MANGUERA DE FRENOS	380486	TRAS DER	23.25"		422
	INFINITI	98-01	MANGUERA DE FRENOS	380487	TRAS IZQ	23.25"		422
	INFINITI	98-01	PISTÓN FRENO DE DISCO	85472	DEL	57.1 mm 2-1/4"		525
	INFINITI	98-01	REPUESTO FRENO DE DISCO	1458	DEL	57.1 mm 2-1/4"		537
	INFINITI	98-01	REPUESTO FRENO DE DISCO	2027	TRAS	34.0 mm		
I-35	INFINITI	02-03	CILINDRO MAESTRO	390639		15/16"	NO SPORT	321
	INFINITI	02-03	CILINDRO MAESTRO	390764		15/16"	SPORT	327
	INFINITI	02-03	MANGUERA DE FRENOS	381588	TRAS IZQ	23.25"		449
	INFINITI	02-03	MANGUERA DE FRENOS	381589	TRAS DER	24.38"		450
ICHI VAN		87-94	PISTÓN FRENO DE DISCO	96542	DEL	60.3 mm 2-3/8"		527
		87-94	REPUESTO FRENO DE DISCO	642	DEL	60.3 mm 2-3/8"		536
		87-94	CILINDRO DE RUEDA	37407	DER	13/16"		365
		87-94	CILINDRO DE RUEDA	37407	IZQ	13/16"		365
		87-94	KIT DE PISTÓN Y REPUESTO FD	742347	DEL	60.3 mm 2-3/8"		
		87-94	KIT DE PISTÓN Y REPUESTO FD	742348	DEL	60.3 mm 2-3/8"		
		87-94	REP. CIL. MAESTRO Y DE CLUTCH	691		23.8 mm 15/16"		556
LUCINO	GSE	96-00	CILINDRO MAESTRO	390318		7/8"	S/ABS	308
	GSE	96-00	CILINDRO MAESTRO	390319		7/8"	C/ABS	308
	GSE	96-00	MANGUERA DE FRENOS	380489	DEL DER	18.25"		422
	GSE	96-00	MANGUERA DE FRENOS	380490	DEL IZQ	18.25"		423
	GSE	96-00	MANGUERA DE FRENOS	380507	TRAS DER	21.5"		423
	GSE	96-00	MANGUERA DE FRENOS	380508	TRAS IZQ	21.25"		423
	GSE	96-00	PISTÓN FRENO DE DISCO	85209	DEL	54.0 mm 2-1/8"		521
	GSE	96-00	REP. CIL. MAESTRO Y DE CLUTCH	90318		22.2 mm 7/8"		559
	GSE	96-00	REPUESTO FRENO DE DISCO	643	DEL	54.0 mm 2-1/8"		536
	GSE	96-00	REPUESTO FRENO DE DISCO	2020	DEL	54.0 mm 2-1/8"		538
	GSR	96-00	CILINDRO MAESTRO	390318		7/8"	S/ABS	308
	GSR	96-00	CILINDRO MAESTRO	390319		7/8"	C/ABS	308
	GSR	96-00	MANGUERA DE FRENOS	380489	DEL DER	18.25"		422
	GSR	96-00	MANGUERA DE FRENOS	380490	DEL IZQ	18.25"		423
	GSR	96-00	MANGUERA DE FRENOS	380507	TRAS DER	21.5"		423
	GSR	96-00	MANGUERA DE FRENOS	380508	TRAS IZQ	21.25"		423
	GSR	96-00	PISTÓN FRENO DE DISCO	85209	DEL	54.0 mm 2-1/8"		521
	GSR	96-00	REP. CIL. MAESTRO Y DE CLUTCH	90318		22.2 mm 7/8"		559
	GSR	96-00	REPUESTO FRENO DE DISCO	2020	DEL	54.0 mm 2-1/8"		538
	MARCH		12-14	CILINDRO DE RUEDA	370254	DER	N/D	
		12-14	CILINDRO DE RUEDA	370254	IZQ	N/D		382
MAXIMA		91-93	MANGUERA DE FRENOS	38683	DEL DER	12.25"		396
		91-93	MANGUERA DE FRENOS	38683	DEL IZQ	12.25"		396
		91-93	MANGUERA DE FRENOS	38689	TRAS DER	19.63"		396
		91-93	MANGUERA DE FRENOS	38689	TRAS IZQ	19.63"		396
		91-93	MANGUERA DE FRENOS	38701	DEL DER	21.5"		397
		91-93	MANGUERA DE FRENOS	38701	DEL IZQ	21.5"		397



Modelo	Versión	Año	Descripción	Número Lusac	Posición	Diámetro	Notas	Foto Pág.	
MAXIMA		95-01	MANGUERA DE FRENOS	380486	TRAS DER	23.25"		422	
		95-01	MANGUERA DE FRENOS	380487	TRAS IZQ	23.25"		422	
		02-03	MANGUERA DE FRENOS	381588	TRAS IZQ	23.25"		449	
		02-03	MANGUERA DE FRENOS	381589	TRAS DER	24.38"		450	
		91-93	PISTÓN FRENO DE DISCO	85472	DEL	57.1 mm 2-1/4"		525	
		95-03	PISTÓN FRENO DE DISCO	85472	DEL	57.1 mm 2-1/4"		525	
		02-03	PISTÓN FRENO DE DISCO	851470	TRAS	34.9 mm 1-3/8"		534	
		91-93	REPUESTO FRENO DE DISCO	1458	DEL	57.1 mm 2-1/4"		537	
		95-03	REPUESTO FRENO DE DISCO	1458	DEL	57.1 mm 2-1/4"		537	
		91-93	REPUESTO FRENO DE DISCO	2027	TRAS	34.0 mm			
		95-01	REPUESTO FRENO DE DISCO	2027	TRAS	34.0 mm			
		02-03	REPUESTO FRENO DE DISCO	21470	TRAS	34.9 mm 1-3/8"		551	
		SE	04-08	CILINDRO MAESTRO	390007		3/4"	C/ABS	299
		SE	04-08	CILINDRO MAESTRO	390858		15/16"	S/C DE ESTABILIDAD	332
		SE	04-08	CILINDRO MAESTRO	390859		15/16"	C/C DE ESTABILIDAD	332
		SE	04-08	MANGUERA DE FRENOS	381594	DEL DER	20.5"		450
		SE	04-14	PISTÓN FRENO DE DISCO	85472	DEL	57.1 mm 2-1/4"		525
		SE	04-08	PISTÓN FRENO DE DISCO	851470	TRAS	34.9 mm 1-3/8"		534
		SE	04-14	REPUESTO FRENO DE DISCO	1458	DEL	57.1 mm 2-1/4"		537
		SE	04-08	REPUESTO FRENO DE DISCO	21470	TRAS	34.9 mm 1-3/8"		551
			95-00	CILINDRO DE CLUTCH	350081		15.8 mm 5/8"		
			04-06	CILINDRO DE CLUTCH	360139		17.4 mm 11/16"		
			91-93	CILINDRO MAESTRO	39797		15/16"	S/ABS	295
			91-93	CILINDRO MAESTRO	39799		1"	C/ABS	295
			95-99	CILINDRO MAESTRO	390233		15/16"	C/ABS	304
			95-99	CILINDRO MAESTRO	390234		15/16"	NABCO S/ABS	304
			95-01	CILINDRO MAESTRO	390235		15/16"	TOKICO S/ABS	304
			00-03	CILINDRO MAESTRO	390639		15/16"		321
			04-08	KIT DE PISTÓN Y REPUESTO FD	742395	TRAS	34.9 mm 1-3/8"		
			00-14	KIT DE PISTÓN Y REPUESTO FD	742398	DEL	57.1 mm 2-1/4"		
			94-94	MANGUERA DE FRENOS	380486	DER	23.25"		422
			94-94	MANGUERA DE FRENOS	380487	IZQ	23.25"		422
			95-01	REP. CIL. MAESTRO Y DE CLUTCH	90234		23.8 mm 15/16"		558
MICRA		05-07	KIT DE PISTÓN Y REPUESTO FD	742407	DEL	54.0 mm 2-1/8"			
		05-07	PISTÓN FRENO DE DISCO	85860	DEL	54.0 mm 2-1/8"		527	
		05-07	REPUESTO FRENO DE DISCO	21994	DEL	54.0 mm 2-1/8"		551	
MURANO		04-08	MANGUERA DE FRENOS	382658	DEL IZQ	23.12"		480	
		04-08	MANGUERA DE FRENOS	382659	DEL DER	23"		480	
		04-10	PISTÓN FRENO DE DISCO	851001	DEL	63.5 mm 2-1/2"		530	
		04-10	REPUESTO FRENO DE DISCO	21001	DEL	63.5 mm 2-1/2"		545	





Modelo	Versión	Año	Descripción	Número Lusac	Posición	Diámetro	Notas	Foto Pág.
NISSAN								
MURANO		04-10	KIT DE PISTÓN Y REPUESTO FD	742403	DEL	63.5 mm 2-1/2"		
NINJA	TURBO	86-87	CILINDRO DE RUEDA	37407	DER	13/16"		365
	TURBO	86-87	CILINDRO DE RUEDA	37407	IZQ	13/16"		365
	TURBO	86-87	CILINDRO MAESTRO	39406		3/4" & 15/16"		294
	TURBO	86-87	MANGUERA DE FRENOS	4055	DEL DER	22 1/4"		
	TURBO	86-87	MANGUERA DE FRENOS	4055	DEL IZQ	22 1/4"		
	TURBO	86-87	MANGUERA DE FRENOS	2032M	TRAS IZQ	11"		516
	TURBO	86-87	PISTÓN FRENO DE DISCO	6000	DEL	48.0 mm 1-57/64"		518
	TURBO	86-87	REP. CIL. MAESTRO Y DE CLUTCH	688		19.0 mm 3/4"		
	TURBO	86-87	REPUESTO FRENO DE DISCO	641	DEL	48.0 mm 1-57/64"		536
		86-87	KIT DE PISTÓN Y REPUESTO FD	742331	DEL	48.0 mm 1-57/64"	TURBO	
NP300	PICK UP LARGO	09-12	CILINDRO DE RUEDA	37684	DER	15/16"	GASOLINA	365
	PICK UP LARGO	09-12	CILINDRO DE RUEDA	37684	IZQ	15/16"	GASOLINA	365
	PICK UP LARGO	09-12	CILINDRO DE RUEDA	441007Z0	IZQ	22.2 mm 7/8"	DIESEL	
	PICK UP LARGO	09-12	CILINDRO DE RUEDA	441007Z8	DER	22.2 mm 7/8"	DIESEL	
	PICK UP LARGO	09-12	CILINDRO DE RUEDA	44100F40	DER	23.8 mm 15/16"	GASOLINA	
	PICK UP LARGO	09-12	CILINDRO DE RUEDA	44100F40	IZQ	23.8 mm 15/16"	GASOLINA	
	PICK UP LARGO	09-14	PISTÓN FRENO DE DISCO	85177	DEL	42.8 mm 1-11/16"		521
	PICK UP LARGO	09-14	REPUESTO FRENO DE DISCO	1668	DEL	42.8 mm 1-11/16"		537
	PICK-UP, DOBLE CABINA	09-12	CILINDRO DE RUEDA	37684	DER	15/16"	GASOLINA	365
	PICK-UP, DOBLE CABINA	09-12	CILINDRO DE RUEDA	37684	IZQ	15/16"	GASOLINA	365
	PICK-UP, DOBLE CABINA	09-12	CILINDRO DE RUEDA	441007Z0	IZQ	22.2 mm 7/8"	DIESEL	
	PICK-UP, DOBLE CABINA	09-12	CILINDRO DE RUEDA	441007Z8	DER	22.2 mm 7/8"	DIESEL	
	PICK-UP, DOBLE CABINA	09-12	CILINDRO DE RUEDA	44100F40	DER	23.8 mm 15/16"	GASOLINA	
	PICK-UP, DOBLE CABINA	09-12	CILINDRO DE RUEDA	44100F40	IZQ	23.8 mm 15/16"	GASOLINA	
	PICK-UP, DOBLE CABINA	09-14	PISTÓN FRENO DE DISCO	85177	DEL	42.8 mm 1-11/16"		521
	PICK-UP, DOBLE CABINA	09-14	REPUESTO FRENO DE DISCO	1668	DEL	42.8 mm 1-11/16"		537
PATHFINDER		97-04	MANGUERA DE FRENOS	380716	TRAS IZQ	16.25"		426
		97-04	MANGUERA DE FRENOS	380761	DEL DER	22.25"		427
		97-04	MANGUERA DE FRENOS	380761	DEL IZQ	22.25"		427
		03-03	MANGUERA DE FRENOS	381652	TRAS DER	16.25"		453
		97-98	PISTÓN FRENO DE DISCO	85177	DEL	42.8 mm 1-11/16"	CALIPER DOBLE PISTON	521

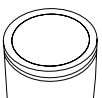

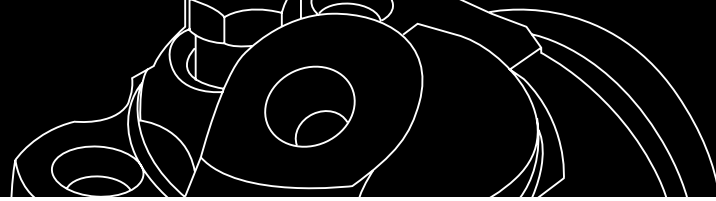

Modelo	Versión	Año	Descripción	Número Lusac	Posición	Diámetro	Notas	Foto Pág.
PATHFINDER		99-04	PISTÓN FRENO DE DISCO	85216	DEL	44.4 mm 1-3/4"	CALIPER DOBLE PISTON	522
		97-98	REPUESTO FRENO DE DISCO	1668	DEL	42.8 mm 1-11/16"	CALIPER DOBLE PISTON	537
		99-04	REPUESTO FRENO DE DISCO	2216	DEL	44.4 mm 1-3/4"	CALIPER DOBLE PISTON	540
	DOBLE CABINA	97-00	CILINDRO MAESTRO	390347		1"	CAL DOBLE PISTON	310
		96-98	CILINDRO DE CLUTCH	37627		19.0 mm 3/4"	CHOCOLATE	
		97-00	CILINDRO DE CLUTCH	350093		15.8 mm 5/8"		
		97-98	CILINDRO DE RUEDA	37871	DER	13/16"		368
		97-98	CILINDRO DE RUEDA	37871	IZQ	13/16"		368
		02-04	CILINDRO DE RUEDA	370154	DER	7/8"		379
		02-04	CILINDRO DE RUEDA	370154	IZQ	7/8"		379
		99-01	CILINDRO DE RUEDA	441007Z0	IZQ	22.2 mm 7/8"		
		99-01	CILINDRO DE RUEDA	441007Z8	DER	22.2 mm 7/8"		
		96-01	CILINDRO MAESTRO	390342		1"	4X4	310
		96-01	CILINDRO MAESTRO	390347		1"	4X2	310
		02-04	CILINDRO MAESTRO	390835		1"		331
		05-12	CILINDRO MAESTRO	391096		1"		342
		05-09	CILINDRO MAESTRO	391098		1"		342
		08-12	CILINDRO MAESTRO	391411		26.9 mm 1-1/16"	8 V	
		97-98	KIT DE PISTÓN Y REPUESTO FD	742327	DEL	42.8 mm 1-11/16"		
		96-96	MANGUERA DE FRENOS	380716	CTR	16.25"		426
	96-96	MANGUERA DE FRENOS	380761	DEL IZQ DER	22.25"		427	
PICKUP NISSAN	250	94-96	CILINDRO DE RUEDA	37872	DER	7/8"		368
	250	94-96	CILINDRO DE RUEDA	37872	IZQ	7/8"		368
	250	94-96	CILINDRO MAESTRO	39593		1"		294
	250	94-96	CILINDRO MAESTRO	46010F40		23.8 mm 15/16"		362
	D-21, INCLUYE ESTAQUITAS	91-96	CILINDRO DE RUEDA	37208	TRAS IZQ DER	3/4"		364
	D-21, INCLUYE ESTAQUITAS	84-94	CILINDRO DE RUEDA	37208	DER	3/4"		364
	D-21, INCLUYE ESTAQUITAS	84-96	CILINDRO DE RUEDA	37208	IZQ	3/4"		364
	D-21, INCLUYE ESTAQUITAS	84-86	CILINDRO DE RUEDA	37209	DER	13/16"		364
	D-21, INCLUYE ESTAQUITAS	95-03	CILINDRO DE RUEDA	37209	DER	13/16"		364
	D-21, INCLUYE ESTAQUITAS	84-86	CILINDRO DE RUEDA	37209	IZQ	13/16"		364
	D-21, INCLUYE ESTAQUITAS	95-03	CILINDRO DE RUEDA	37209	IZQ	13/16"		364
	D-21, INCLUYE ESTAQUITAS	84-86	CILINDRO DE RUEDA	37210	DER	13/16"		364
	D-21, INCLUYE ESTAQUITAS	84-86	CILINDRO DE RUEDA	37210	IZQ	13/16"		364
	D-21, INCLUYE ESTAQUITAS	87-11	CILINDRO DE RUEDA	37684	DER	15/16"		365





Modelo	Versión	Año	Descripción	Número Lusac	Posición	Diámetro	Notas	Foto Pág.
NISSAN								
PICKUP NISSAN	D-21, INCLUYE ESTAQUITAS	87-11	CILINDRO DE RUEDA	37684	IZQ	15/16"		365
	D-21, INCLUYE ESTAQUITAS	95-03	CILINDRO DE RUEDA	37871	IZQ	13/16"		368
	D-21, INCLUYE ESTAQUITAS	90-01	CILINDRO DE RUEDA	37872	DER	7/8"		368
	D-21, INCLUYE ESTAQUITAS	90-01	CILINDRO DE RUEDA	37872	IZQ	7/8"		368
	D-21, INCLUYE ESTAQUITAS	91-92	CILINDRO MAESTRO	39592		15/16"		294
	D-21, INCLUYE ESTAQUITAS	91-98	CILINDRO MAESTRO	39593		1"	CIL TOKIKO, CAL DOBLE PISTÓN	294
	D-21, INCLUYE ESTAQUITAS	97-01	CILINDRO MAESTRO	39791		15/16"	CAL DE UN PISTON	295
	D-21, INCLUYE ESTAQUITAS	99-01	CILINDRO MAESTRO	39791		15/16"	CAL DE UN PISTON	295
	D-21, INCLUYE ESTAQUITAS	92-00	CILINDRO MAESTRO	390118		1"		301
	D-21, INCLUYE ESTAQUITAS	99-01	CILINDRO MAESTRO	390343		1"	CALIPER DOBLE PISTON	310
	D-21, INCLUYE ESTAQUITAS	96-97	CILINDRO MAESTRO	390344		1"		310
	D-21, INCLUYE ESTAQUITAS	94-08	CILINDRO MAESTRO	46010F40		23.8 mm 15/16"	CIL TOKIKO	362
	D-21, INCLUYE ESTAQUITAS	84-94	MANGUERA DE FRENOS	1208	TRAS IZQ	17 1/4"		385
	D-21, INCLUYE ESTAQUITAS	84-86	MANGUERA DE FRENOS	1211	TRAS DER	12 7/8"		385
	D-21, INCLUYE ESTAQUITAS	84-86	MANGUERA DE FRENOS	1211	TRAS IZQ	12 7/8"		385
	D-21, INCLUYE ESTAQUITAS	95-03	MANGUERA DE FRENOS	38009	TRAS IZQ	22"		387
	D-21, INCLUYE ESTAQUITAS	92-98	MANGUERA DE FRENOS	38481	TRAS IZQ	20.94"		391
	D-21, INCLUYE ESTAQUITAS	84-03	MANGUERA DE FRENOS	38491	DEL IZQ	15.75"		391
	D-21, INCLUYE ESTAQUITAS	84-03	MANGUERA DE FRENOS	38494	DEL DER	15.75"		391
	D-21, INCLUYE ESTAQUITAS	96-97	MANGUERA DE FRENOS	380511	TRAS DER	19.06"		423
	D-21, INCLUYE ESTAQUITAS	97-00	MANGUERA DE FRENOS	380761	DEL DER	22.25"		427
D-21, INCLUYE ESTAQUITAS	97-00	MANGUERA DE FRENOS	380761	DEL IZQ	22.25"		427	

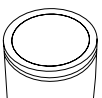



Modelo	Versión	Año	Descripción	Número Lusac	Posición	Diámetro	Notas	Foto Pág.	
PICKUP NISSAN	D-21, INCLUYE ESTAQUITAS	90-11	PISTÓN FRENO DE DISCO	85177	DEL	42.8 mm 1-11/16"		521	
	D-21, INCLUYE ESTAQUITAS	84-10	PISTÓN FRENO DE DISCO	85177	DEL	42.8 mm 1-11/16"	CALIPER DOBLE PISTON	521	
	D-21, INCLUYE ESTAQUITAS	84-03	PISTÓN FRENO DE DISCO	96542	DEL	60.3 mm 2-3/8"		527	
	D-21, INCLUYE ESTAQUITAS	84-03	REP. CIL. MAESTRO Y DE CLUTCH	686		22.2 mm 7/8"		556	
	D-21, INCLUYE ESTAQUITAS	87-03	REP. CIL. MAESTRO Y DE CLUTCH	687		22.2 mm 7/8"			
	D-21, INCLUYE ESTAQUITAS	84-03	REPUESTO FRENO DE DISCO	642	DEL	60.3 mm 2-3/8"		536	
	D-21, INCLUYE ESTAQUITAS	90-08	REPUESTO FRENO DE DISCO	1668	DEL	42.8 mm 1-11/16"		537	
	D-21, INCLUYE ESTAQUITAS	84-11	REPUESTO FRENO DE DISCO	1668	DEL	42.8 mm 1-11/16"	CALIPER DOBLE PISTON	537	
	D-22 - FRONTIER	09-11	CILINDRO DE RUEDA	37684	DER	15/16"		365	
	D-22 - FRONTIER	09-11	CILINDRO DE RUEDA	37684	IZQ	15/16"		365	
	D-22 - FRONTIER	09-11	PISTÓN FRENO DE DISCO	85177	DEL	42.8 mm 1-11/16"		521	
	D-22 - FRONTIER	09-11	REPUESTO FRENO DE DISCO	1668	DEL	42.8 mm 1-11/16"	CALIPER DOBLE PISTON	537	
	DOBLE CABINA	82-83	CILINDRO DE RUEDA	37208	DER	3/4"		364	
	DOBLE CABINA	82-83	CILINDRO DE RUEDA	37208	IZQ	3/4"		364	
	DOBLE CABINA	82-83	MANGUERA DE FRENOS	38491	DEL IZQ	15.75"		391	
	DOBLE CABINA	82-83	MANGUERA DE FRENOS	38494	DEL DER	15.75"		391	
	DOBLE CABINA	82-83	PISTÓN FRENO DE DISCO	96542	DEL	60.3 mm 2-3/8"		527	
	DOBLE CABINA	82-83	REP. CIL. MAESTRO Y DE CLUTCH	686		22.2 mm 7/8"		556	
	DOBLE CABINA	82-83	REPUESTO FRENO DE DISCO	642	DEL	60.3 mm 2-3/8"		536	
	INCLUYE ESTAQUITAS	72-83	CILINDRO DE RUEDA	37209	DER	13/16"		364	
	INCLUYE ESTAQUITAS	72-83	CILINDRO DE RUEDA	37209	IZQ	13/16"		364	
	INCLUYE ESTAQUITAS	72-83	CILINDRO DE RUEDA	37210	DER	13/16"		364	
	INCLUYE ESTAQUITAS	72-83	CILINDRO DE RUEDA	37210	IZQ	13/16"		364	
	NP300 CHASIS, CABINA, GASOLINA	09-12	CILINDRO MAESTRO	39009913			23.8 mm 15/16"		361
		80-86	CILINDRO DE CLUTCH	6600			19.0 mm 3/4"		
		86-97	CILINDRO DE CLUTCH	37680			17.4 mm 11/16"	ACERO	
		96-97	CILINDRO DE CLUTCH	350092			15.8 mm 5/8"		
		72-86	CILINDRO MAESTRO	39087			11/16"	CIL NABCO, CAL DOS PISTONES	294
		87-90	CILINDRO MAESTRO	39276			7/8"	CIL NABCO	294
		82-90	CILINDRO MAESTRO	39276			7/8"	CIL TOKIKO	294





Modelo	Versión	Año	Descripción	Número Lusac	Posición	Diámetro	Notas	Foto Pág.
NISSAN								
PICKUP NISSAN		72-10	KIT DE PISTÓN Y REPUESTO FD	742327	DEL	42.8 mm 1-11/16"		
		72-03	KIT DE PISTÓN Y REPUESTO FD	742347	DEL	60.3 mm 2-3/8"		
		72-03	KIT DE PISTÓN Y REPUESTO FD	742348	DEL	60.3 mm 2-3/8"		
		72-83	MANGUERA DE FRENOS	1208	TRAS IZQ	17 1/4"		385
		72-83	MANGUERA DE FRENOS	1211	TRAS DER	12 7/8"		385
		72-83	MANGUERA DE FRENOS	1211	TRAS IZQ	12 7/8"		385
		72-83	MANGUERA DE FRENOS	38491	DEL IZQ	15.75"		391
		72-83	MANGUERA DE FRENOS	38494	DEL DER	15.75"		391
		72-83	PISTÓN FRENO DE DISCO	85177	DEL	42.8 mm 1-11/16"	CALIPER DOBLE PISTON	521
		72-83	PISTÓN FRENO DE DISCO	96542	DEL	60.3 mm 2-3/8"		527
		72-83	REPUESTO FRENO DE DISCO	642	DEL	60.3 mm 2-3/8"		536
		72-83	REPUESTO FRENO DE DISCO	1668	DEL	42.8 mm 1-11/16"	CALIPER DOBLE PISTON	537
PLATINA		02-10	PISTÓN FRENO DE DISCO	85215	DEL	48.0 mm 1-57/64"		522
		02-10	REPUESTO FRENO DE DISCO	2215	DEL	48.0 mm 1-57/64"		540
		02-10	CILINDRO DE RUEDA	4410000Q	DER	17.4 mm 11/16"		
		02-10	CILINDRO DE RUEDA	4410000Q	IZQ	17.4 mm 11/16"		
		02-10	CILINDRO MAESTRO	4601000Q		20.6 mm 13/16"		362
		02-10	KIT DE PISTÓN Y REPUESTO FD	742423	DEL	48.0 mm 1-57/64"		
Q-45		02-10	REP. CIL. MAESTRO Y DE CLUTCH	904080		20.6 mm 13/16"		562
	INFINITI	97-01	CILINDRO MAESTRO	390483		1"	CIL TOKICO	315
	INFINITI	94-96	MANGUERA DE FRENOS	38982	DEL DER	21.63"		403
	INFINITI	94-96	MANGUERA DE FRENOS	38982	DEL IZQ	21.63"		403
	INFINITI	94-96	MANGUERA DE FRENOS	38983	TRAS DER	21.5"		403
	INFINITI	94-96	MANGUERA DE FRENOS	38983	TRAS IZQ	21.5"		403
	INFINITI	97-02	MANGUERA DE FRENOS	380108	DEL DER	22"		407
	INFINITI	97-02	MANGUERA DE FRENOS	380110	DEL IZQ	22"		407
	INFINITI	94-96	PISTÓN FRENO DE DISCO	85179	DEL	42.8 mm 1-11/16"	CALIPER DOBLE PISTON	521
	INFINITI	94-96	PISTÓN FRENO DE DISCO	85425	TRAS	N/D		524
	INFINITI	94-96	REPUESTO FRENO DE DISCO	1800	DEL	42.8 mm 1-11/16"	CALIPER DOBLE PISTON	537
INFINITI	94-96	REPUESTO FRENO DE DISCO	2783	TRAS	38.1 mm 1-1/2"		543	
QUEST		97-98	MANGUERA DE FRENOS	380103	DEL DER	21.25"		407
		97-98	MANGUERA DE FRENOS	380103	DEL IZQ	21.25"		407
		97-98	MANGUERA DE FRENOS	380104	TRAS DER	13.75"		407
		97-98	MANGUERA DE FRENOS	380104	TRAS IZQ	13.75"		407
		99-02	MANGUERA DE FRENOS	381377	TRAS DER	14.05"		445
		99-02	MANGUERA DE FRENOS	381377	TRAS IZQ	14.05"		445
		04-09	MANGUERA DE FRENOS	382456	DEL DER	23.25"		466
		04-09	MANGUERA DE FRENOS	382587	DEL IZQ	23.25"		474
		04-09	MANGUERA DE FRENOS	382588	TRAS DER	11.81"		474
		04-09	MANGUERA DE FRENOS	382589	TRAS IZQ	11.81"		475
		99-02	MANGUERA DE FRENOS	382627	DEL DER	23.44"		478
		99-02	MANGUERA DE FRENOS	382627	DEL IZQ	23.44"		478

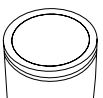



Modelo	Versión	Año	Descripción	Número Lusac	Posición	Diámetro	Notas	Foto Pág.
QUEST		04-09	PISTÓN FRENO DE DISCO	85486	DEL	47.6 mm 1-7/8"	CALIPER DOBLE PISTON	525
		97-02	PISTÓN FRENO DE DISCO	108159	DEL	60.0 mm		528
		04-09	REPUESTO FRENO DE DISCO	2486	DEL	47.6 mm 1-7/8"	CALIPER DOBLE PISTON	542
		97-02	REPUESTO FRENO DE DISCO	108241	DEL	60.0 mm		554
	S, SE, SL	04-09	CILINDRO MAESTRO	390854		1"	S/C DE TRACCIÓN	332
		97-98	CILINDRO DE RUEDA	37857	DER	1"		367
		97-98	CILINDRO DE RUEDA	37857	IZQ	1"		367
		01-02	CILINDRO DE RUEDA	370083	DER	1"		375
		99-02	CILINDRO DE RUEDA	370083	IZQ	1"		375
		97-02	CILINDRO MAESTRO	390115		1"	C/ABS, DEL 99 AL 03; C/ABS, PUEDE UTILIZAR EL CILINDRO MAESTRO 390615 O EL XF5Z2140 (1")	300
		97-98	CILINDRO MAESTRO	390116		1"	S/ABS	300
		99-02	CILINDRO MAESTRO	390584		1"	S/ABS	319
		01-02	CILINDRO MAESTRO	390615		25.4 mm 1"	C/ABS	320
		04-09	CILINDRO MAESTRO	390855		25.4 mm 1"		
		99-02	CILINDRO MAESTRO	390868		1"		332
		97-02	KIT DE PISTÓN Y REPUESTO FD	742324	DEL	60.0 mm		
		04-11	KIT DE PISTÓN Y REPUESTO FD	742377	DEL	47.6 mm 1-7/8"	3.5 6 V CON CALIPER DE DOBLE PISTON	
		93-96	MANGUERA DE FRENOS	380103	DEL IZQ DER	21.25"		407
ROGUE		08-14	CILINDRO MAESTRO	391267		23.8 mm 15/16"		353
SAKURA		85-86	MANGUERA DE FRENOS	4055	DEL DER	22 1/4"		
		85-86	MANGUERA DE FRENOS	4055	DEL IZQ	22 1/4"		
		85-86	MANGUERA DE FRENOS	2032M	TRAS IZQ	11"		516
		85-86	PISTÓN FRENO DE DISCO	6000	DEL	48.0 mm 1-57/64"		518
		85-86	REPUESTO FRENO DE DISCO	641	DEL	48.0 mm 1-57/64"		536
		85-86	CILINDRO DE RUEDA	37407	DER	13/16"		365
		85-86	CILINDRO DE RUEDA	37407	IZQ	13/16"		365
		85-86	KIT DE PISTÓN Y REPUESTO FD	742331	DEL	48.0 mm 1-57/64"		
SAMURAI		70-84	CILINDRO DE CLUTCH	6600		19.0 mm 3/4"		
		81-87	KIT DE PISTÓN Y REPUESTO FD	742331	DEL	48.0 mm 1-57/64"		
SENTRA		92-92	MANGUERA DE FRENOS	38011	TRAS DER	10.25"		388
		92-92	MANGUERA DE FRENOS	38011	TRAS IZQ	10.25"		388
		92-92	MANGUERA DE FRENOS	38865	DEL DER	20.13"		400
		92-92	MANGUERA DE FRENOS	380110	DEL IZQ	22"		407
		96-01	MANGUERA DE FRENOS	380489	DEL DER	18.25"		422
		96-01	MANGUERA DE FRENOS	380490	DEL IZQ	18.25"		423
		01-01	MANGUERA DE FRENOS	380507	TRAS DER	21.5"		423
		01-01	MANGUERA DE FRENOS	380508	TRAS IZQ	21.25"		423
		96-01	MANGUERA DE FRENOS	380512	TRAS IZQ	13.25"		423
		01-06	MANGUERA DE FRENOS	381580	TRAS DER	13.28"		449
		01-06	MANGUERA DE FRENOS	381581	TRAS IZQ	13.28"		449
		01-06	MANGUERA DE FRENOS	381591	DEL DER	19.5"		450
		00-06	MANGUERA DE FRENOS	381592	DEL DER	21.5"	DS 2.0 LTS	450
		92-92	PISTÓN FRENO DE DISCO	6000	DEL	48.0 mm 1-57/64"		518





Modelo	Versión	Año	Descripción	Número Lusac	Posición	Diámetro	Notas	Foto Pág.
NISSAN								
		96-00	PISTÓN FRENO DE DISCO	85209	DEL	54.0 mm 2-1/8"		521
		01-12	PISTÓN FRENO DE DISCO	85472	DEL	57.1 mm 2-1/4"		525
		92-92	REPUESTO FRENO DE DISCO	641	DEL	48.0 mm 1-57/64"		536
		96-00	REPUESTO FRENO DE DISCO	643	DEL	54.0 mm 2-1/8"		536
		96-00	REPUESTO FRENO DE DISCO	2020	DEL	54.0 mm 2-1/8"		538
		01-01	REPUESTO FRENO DE DISCO	2144	TRAS	30.1 mm 1-3/16"		
		01-12	REPUESTO FRENO DE DISCO	2472	DEL	57.1 mm 2-1/4"		541
	2	95-95	MANGUERA DE FRENOS	380489	DER	18.25"		422
	2	95-95	MANGUERA DE FRENOS	380490	IZQ	18.25"		423
	2	95-95	MANGUERA DE FRENOS	380507	DER	21.5"	DISCO-DISCO	423
	2	95-95	MANGUERA DE FRENOS	380508	IZQ	21.25"	DISCO-DISCO	423
	2	95-95	MANGUERA DE FRENOS	380512	TRAS	13.25"	DISCO-TAMBOR	423
	GSS	96-00	CILINDRO DE RUEDA	37869	DER	15.8 mm 5/8"	TAMBIÉN UTILIZAR 114197	368
	GSS	96-00	CILINDRO DE RUEDA	37869	IZQ	15.8 mm 5/8"	TAMBIÉN UTILIZAR 114197	368
	GSS	96-00	CILINDRO MAESTRO	390318		7/8"	S/ABS 4CIL 2.0 LTS	308
	GSS	96-00	CILINDRO MAESTRO	390319		7/8"	C/ABS 4CIL 2.0 LTS	308
	GSS	96-00	MANGUERA DE FRENOS	380489	DEL DER	18.25"		422
	GSS	96-00	MANGUERA DE FRENOS	380490	DEL IZQ	18.25"		423
	GSS	96-00	MANGUERA DE FRENOS	380507	TRAS DER	21.5"		423
	GSS	96-00	MANGUERA DE FRENOS	380508	TRAS IZQ	21.25"		423
	GSS	96-00	MANGUERA DE FRENOS	380512	TRAS IZQ	13.25"		423
	GSS	96-00	PISTÓN FRENO DE DISCO	85209	DEL	54.0 mm 2-1/8"		521
	GSS	96-00	REP. CIL. MAESTRO Y DE CLUTCH	90318		22.2 mm 7/8"	4CIL 2.0 LTS	559
	GSS	96-00	REPUESTO FRENO DE DISCO	2020	DEL	54.0 mm 2-1/8"		538
	GSS	96-00	REPUESTO FRENO DE DISCO	2144	TRAS	30.1 mm 1-3/16"		
	GST, GSX	00-09	CILINDRO DE RUEDA	37869	DER	15.8 mm 5/8"	TAMBIÉN UTILIZAR 114197	368
	GST, GSX	00-09	CILINDRO DE RUEDA	37869	IZQ	15.8 mm 5/8"	TAMBIÉN UTILIZAR 114197	368
	GST, GSX	00-00	CILINDRO DE RUEDA	441004Z0	DER	17.4 mm 11/16"		
	GST, GSX	00-00	CILINDRO DE RUEDA	441004Z0	IZQ	17.4 mm 11/16"		
	GST, GSX	96-00	CILINDRO MAESTRO	390317		13/16"	S/ABS, TOKIKO	308
	GST, GSX	96-00	CILINDRO MAESTRO	390319		7/8"	C/ABS	308
	GST, GSX	96-00	REP. CIL. MAESTRO Y DE CLUTCH	694		20.6 mm 13/16"		556
	SE	01-01	CILINDRO DE RUEDA	37869	DER	15.8 mm 5/8"	TAMBIÉN UTILIZAR 114197	368
	SE	01-01	CILINDRO DE RUEDA	37869	IZQ	15.8 mm 5/8"	TAMBIÉN UTILIZAR 114197	368
	SE	01-01	CILINDRO MAESTRO	390747		5/16"	C/ABS	325
	SE	01-01	MANGUERA DE FRENOS	380489	DEL DER	18.25"		422
	SE	01-01	MANGUERA DE FRENOS	380490	DEL IZQ	18.25"		423
	SE	01-01	MANGUERA DE FRENOS	380507	TRAS DER	21.5"		423
	SE	01-01	MANGUERA DE FRENOS	380508	TRAS IZQ	21.25"		423
	SE	01-01	MANGUERA DE FRENOS	380512	TRAS DER	13.25"		423
	SE	01-01	MANGUERA DE FRENOS	380512	TRAS IZQ	13.25"		423

SENTRA

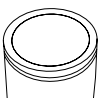



Modelo	Versión	Año	Descripción	Número Lusac	Posición	Diámetro	Notas	Foto Pág.	
SENTRA	SE	01-01	PISTÓN FRENO DE DISCO	85209	DEL	54.0 mm 2-1/8"		521	
	SE	01-01	REP. CIL. MAESTRO Y DE CLUTCH	90234		23.8 mm 15/16"		558	
	SE	01-01	REPUESTO FRENO DE DISCO	2020	DEL	54.0 mm 2-1/8"		538	
	SE	01-01	REPUESTO FRENO DE DISCO	2144	TRAS	30.1 mm 1-3/16"			
	SE-R	01-09	CILINDRO MAESTRO	390234		15/16"	S/ABS 4CIL 2.5 LTS	304	
	SE-R	02-09	CILINDRO MAESTRO	390747		5/16"	C/ABS 4CIL 2.5 LTS	325	
	SE-R	02-06	CILINDRO MAESTRO	390748		1-1/16"	C/ABS 4CIL 2.5 LTS	326	
	SE-R	02-06	CILINDRO MAESTRO	390749		1-1/16"	S/ABS 4CIL 2.5 LTS	326	
	SE-R	02-06	MANGUERA DE FRENOS	381591	DEL DER	19.5"		450	
	SE-R	02-06	MANGUERA DE FRENOS	381592	TRAS DER	21.5"		450	
	SE-R	02-06	PISTÓN FRENO DE DISCO	85472	DEL	57.1 mm 2-1/4"		525	
	SE-R	08-12	PISTÓN FRENO DE DISCO	85472	DEL	57.1 mm 2-1/4"		525	
	SE-R	02-06	REP. CIL. MAESTRO Y DE CLUTCH	90234		23.8 mm 15/16"	4CIL 2.5 LTS	558	
	SE-R	08-12	REP. CIL. MAESTRO Y DE CLUTCH	90234		23.8 mm 15/16"	4CIL 2.5 LTS	558	
	SE-R	02-06	REPUESTO FRENO DE DISCO	2144	TRAS	30.1 mm 1-3/16"			
	SE-R	02-06	REPUESTO FRENO DE DISCO	2472	DEL	57.1 mm 2-1/4"		541	
	SE-R	08-12	REPUESTO FRENO DE DISCO	2472	DEL	57.1 mm 2-1/4"		541	
	XE, GXE	01-01	CILINDRO DE RUEDA	WC370141	DER	11/16"	TAMBIÉN UTILIZAR 441004Z0		
	XE, GXE	01-01	CILINDRO DE RUEDA	WC370141	IZQ	11/16"	TAMBIÉN UTILIZAR 441004Z0		
	XE, GXE	02-02	CILINDRO DE RUEDA	370142	DER	15.8 mm 5/8"		378	
	XE, GXE	02-02	CILINDRO DE RUEDA	370142	IZQ	15.8 mm 5/8"		378	
	XE, GXE	01-06	CILINDRO DE RUEDA	370157	DER	15.8 mm 5/8"		379	
	XE, GXE	01-06	CILINDRO DE RUEDA	370157	IZQ	15.8 mm 5/8"		379	
	XE, GXE	07-12	CILINDRO DE RUEDA	370212	IZQ	3/4"		381	
	XE, GXE	01-09	CILINDRO MAESTRO	390234		15/16"	S/ABS	304	
	XE, GXE	01-09	CILINDRO MAESTRO	390747		5/16"	C/ABS	325	
	XE, GXE	01-06	REP. CIL. MAESTRO Y DE CLUTCH	90234		23.8 mm 15/16"		558	
	XE, GXE	01-01	REP. CIL. MAESTRO Y DE CLUTCH	90234		23.8 mm 15/16"	4CIL 1.8 LTS	558	
		92-92	CILINDRO DE RUEDA	37869	DER	15.8 mm 5/8"	TAMBIÉN UTILIZAR 114197	368	
		92-92	CILINDRO DE RUEDA	37869	IZQ	15.8 mm 5/8"	TAMBIÉN UTILIZAR 114197	368	
		07-11	CILINDRO DE RUEDA	370214	TRAS DER	15.8 mm 5/8"	C/ABS	382	
		07-11	CILINDRO DE RUEDA	370214	TRAS IZQ	15.8 mm 5/8"	C/ABS	382	
		92-92	CILINDRO MAESTRO	390004		13/16"	CIL TOKICO 4CIL 1.6 LTS	299	
		07-10	CILINDRO MAESTRO	391306		23.8 mm 15/16"		354	
		07-10	CILINDRO MAESTRO	391307		23.8 mm 15/16"		354	
		92-92	KIT DE PISTÓN Y REPUESTO FD	742331	DEL	48.0 mm 1-57/64"	1.6		
		92-92	MANGUERA DE FRENOS	38866	TRAS	18.75"		400	
	TIIDA		07-14	PISTÓN FRENO DE DISCO	85402	DEL	54.0 mm 2-1/8"		524
			07-14	REPUESTO FRENO DE DISCO	21017	DEL	54.0 mm 2-1/8"		546





Modelo	Versión	Año	Descripción	Número Lusac	Posición	Diámetro	Notas	Foto Pág.	
NISSAN									
TIIDA	SEDAN, HATCH BACK	07-12	CILINDRO DE RUEDA	370213	DER	11/16"		382	
	SEDAN, HATCH BACK	07-12	CILINDRO DE RUEDA	370213	IZQ	11/16"		382	
	SEDAN, HATCH BACK	10-12	CILINDRO MAESTRO	391155		15/16"	AUTOMATICO	345	
	SEDAN, HATCH BACK	10-12	CILINDRO MAESTRO	391156		15/16"	ESTÁNDAR	345	
	SEDAN, HATCH BACK	07-12	CILINDRO MAESTRO	391304		7/8"		353	
		07-11	CILINDRO DE RUEDA	370214	TRAS DER	15.8 mm 5/8"	C/ABS	382	
		07-11	CILINDRO DE RUEDA	370214	TRAS IZQ	15.8 mm 5/8"	C/ABS	382	
	07-13	KIT DE PISTÓN Y REPUESTO FD	742397	DEL	54.0 mm 2-1/8"				
TITAN		04-05	MANGUERA DE FRENOS	381653	DEL DER	20.25"		453	
		04-07	MANGUERA DE FRENOS	382564	DEL IZQ	18.88"		472	
		04-07	MANGUERA DE FRENOS	382565	DEL DER	18.88"		473	
		04-07	MANGUERA DE FRENOS	382567	TRAS DER	15"		473	
		04-07	CILINDRO MAESTRO	390879		28.5 mm 1-1/8"	4X2 S/CONTROL DINAMICO	333	
		04-14	CILINDRO MAESTRO	391072		1-3/16"		341	
TSUBAME		93-04	PISTÓN FRENO DE DISCO	6000	DEL	48.0 mm 1-57/64"		518	
		01-04	PISTÓN FRENO DE DISCO	6000	DEL	48.0 mm 1-57/64"		518	
		93-99	REPUESTO FRENO DE DISCO	641	DEL	48.0 mm 1-57/64"		536	
		01-04	REPUESTO FRENO DE DISCO	641	DEL	48.0 mm 1-57/64"		536	
		93-99	CILINDRO DE RUEDA	37358	DER	11/16"		365	
		01-04	CILINDRO DE RUEDA	37358	DER	11/16"		365	
		93-99	CILINDRO DE RUEDA	37358	IZQ	11/16"		365	
		01-04	CILINDRO DE RUEDA	37358	IZQ	11/16"		365	
		93-99	CILINDRO MAESTRO	390006		3/4"		299	
		01-04	CILINDRO MAESTRO	390006		3/4"		299	
		93-04	KIT DE PISTÓN Y REPUESTO FD	742331	DEL	48.0 mm 1-57/64"			
		93-99	REP. CIL. MAESTRO Y DE CLUTCH	694		20.6 mm 13/16"		556	
		GSR 2000	93-96	CILINDRO DE RUEDA	37869	DER	15.8 mm 5/8"		368
		GSR 2000	93-96	CILINDRO DE RUEDA	37869	IZQ	15.8 mm 5/8"		368
TSURU		GSR 2000	93-96	CILINDRO DE RUEDA	114197	DER	15.8 mm 5/8"		373
		GSR 2000	93-96	CILINDRO DE RUEDA	114197	IZQ	15.8 mm 5/8"		373
		GSR 2000	93-96	CILINDRO MAESTRO	390318		7/8"	2.0 LTS	308
		GSR 2000	93-96	MANGUERA DE FRENOS	38014	TRAS IZQ	11.16"		388
		GSR 2000	93-96	MANGUERA DE FRENOS	380489	DEL DER	18.25"		422
		GSR 2000	93-96	MANGUERA DE FRENOS	380490	DEL IZQ	18.25"		423
		GSR 2000	93-96	MANGUERA DE FRENOS	380507	TRAS DER	21.5"		423
		GSR 2000	93-96	MANGUERA DE FRENOS	380508	TRAS IZQ	21.25"		423
		GSR 2000	93-96	PISTÓN FRENO DE DISCO	85209	DEL	54.0 mm 2-1/8"		521
		GSR 2000	93-96	REP. CIL. MAESTRO Y DE CLUTCH	90318		22.2 mm 7/8"		559
		GSR 2000	93-96	REPUESTO FRENO DE DISCO	2020	DEL	54.0 mm 2-1/8"		538

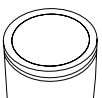

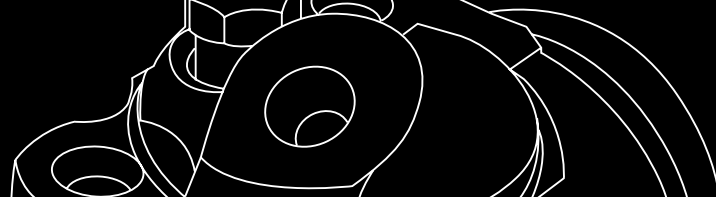

Modelo	Versión	Año	Descripción	Número Lusac	Posición	Diámetro	Notas	Foto Pág.
TSURU	GSR 2000	93-96	REPUESTO FRENO DE DISCO	2144	TRAS	30.1 mm 1-3/16"		
	I	84-87	CILINDRO DE RUEDA	117345	DER	19.0 mm 3/4"		374
	I	84-87	CILINDRO DE RUEDA	117345	IZQ	19.0 mm 3/4"		374
	I	84-87	CILINDRO MAESTRO	39406		3/4" & 15/16"	CIL NABCO	294
	I	84-87	CILINDRO MAESTRO	39555		3/4" & 15/16"	CIL TOKICO	294
	I	84-87	CILINDRO MAESTRO	46010A05		19.0mm/23.8mm		362
	I	84-87	MANGUERA DE FRENOS	38496	DEL DER	20.63"		391
	I	84-87	MANGUERA DE FRENOS	38496	DEL IZQ	20.63"		391
	I	84-87	MANGUERA DE FRENOS	2032M	TRAS IZQ	11"		516
	I	84-87	PISTÓN FRENO DE DISCO	6000	DEL	48.0 mm 1-57/64"		518
	I	84-87	REP. CIL. MAESTRO Y DE CLUTCH	681		19.0 mm 3/4"		
	I	84-87	REP. CIL. MAESTRO Y DE CLUTCH	688		19.0 mm 3/4"		
	I	84-87	REPUESTO FRENO DE DISCO	641	DEL	48.0 mm 1-57/64"		536
	I VAGONETA	84-87	CILINDRO DE RUEDA	117345	DER	19.0 mm 3/4"		374
	I VAGONETA	84-87	CILINDRO DE RUEDA	117345	IZQ	19.0 mm 3/4"		374
	I VAGONETA	84-87	CILINDRO MAESTRO	39406		3/4" & 15/16"	CIL NABCO	294
	I VAGONETA	84-87	CILINDRO MAESTRO	39555		3/4" & 15/16"	CIL TOKICO	294
	I VAGONETA	84-87	CILINDRO MAESTRO	46010A05		19.0mm/23.8mm		362
	I VAGONETA	84-87	MANGUERA DE FRENOS	38496	DEL DER	20.63"		391
	I VAGONETA	84-87	MANGUERA DE FRENOS	38496	DEL IZQ	20.63"		391
	I VAGONETA	84-87	MANGUERA DE FRENOS	2032M	TRAS IZQ	11"		516
	I VAGONETA	84-87	PISTÓN FRENO DE DISCO	6000	DEL	48.0 mm 1-57/64"		518
	I VAGONETA	84-87	REP. CIL. MAESTRO Y DE CLUTCH	681		19.0 mm 3/4"		
	I VAGONETA	84-87	REP. CIL. MAESTRO Y DE CLUTCH	688		19.0 mm 3/4"		
	I VAGONETA	84-87	REPUESTO FRENO DE DISCO	641	DEL	48.0 mm 1-57/64"		536
	II	88-92	CILINDRO DE RUEDA	117345	DER	19.0 mm 3/4"		374
	II	88-92	CILINDRO DE RUEDA	117345	IZQ	19.0 mm 3/4"		374
	II	88-92	CILINDRO MAESTRO	39406		3/4" & 15/16"	CIL NABCO	294
	II	88-92	CILINDRO MAESTRO	39555		3/4" & 15/16"	CIL TOKICO	294
	II	88-92	CILINDRO MAESTRO	46010A05		19.0mm/23.8mm		362
	II	88-92	MANGUERA DE FRENOS	38496	DEL DER	20.63"		391
	II	88-92	MANGUERA DE FRENOS	38496	DEL IZQ	20.63"		391
	II	88-92	MANGUERA DE FRENOS	2032M	TRAS IZQ	11"		516
	II	88-92	PISTÓN FRENO DE DISCO	6000	DEL	48.0 mm 1-57/64"		518
	II	88-92	REP. CIL. MAESTRO Y DE CLUTCH	681		19.0 mm 3/4"		
	II	88-92	REP. CIL. MAESTRO Y DE CLUTCH	688		19.0 mm 3/4"		
	II	88-92	REPUESTO FRENO DE DISCO	641	DEL	48.0 mm 1-57/64"		536
	III GS	93-15	CILINDRO DE RUEDA	114197	DER	15.8 mm 5/8"		373
	III GS	93-15	CILINDRO DE RUEDA	114197	IZQ	15.8 mm 5/8"		373
	III GS	93-15	CILINDRO MAESTRO	390006		3/4"	CIL NABCO	299
	III GS	93-15	MANGUERA DE FRENOS	38014	TRAS IZQ	11.16"		388
	III GS	93-15	MANGUERA DE FRENOS	38496	DEL DER	20.63"		391
	III GS	93-15	MANGUERA DE FRENOS	38496	DEL IZQ	20.63"		391
	III GS	93-15	PISTÓN FRENO DE DISCO	6000	DEL	48.0 mm 1-57/64"		518





Modelo	Versión	Año	Descripción	Número Lusac	Posición	Diámetro	Notas	Foto Pág.
NISSAN								
TSURU	III GS	93-15	REP. CIL. MAESTRO Y DE CLUTCH	693		19.0 mm 3/4"		556
	III GS	93-15	REPUESTO FRENO DE DISCO	641	DEL	48.0 mm 1-57/64"		536
		84-15	KIT DE PISTÓN Y REPUESTO FD	742331	DEL	48.0 mm 1-57/64"		
		93-96	REPUESTO CILINDRO DE RUEDA	114198		15.8 mm 5/8"		
URVAN	CARGA	00-11	CILINDRO DE RUEDA	37870	IZQ	13/16"		368
	CARGA	02-11	CILINDRO MAESTRO	39009908		1"	C/ABS	361
	CARGA	00-11	CILINDRO MAESTRO	39009910		1"	S/ABS	361
	CARGA	00-01	PISTÓN FRENO DE DISCO	85177	DEL	42.8 mm 1-11/16"	CALIPER DOBLE PISTON	521
	CARGA	00-11	PISTÓN FRENO DE DISCO	85486	DEL	47.6 mm 1-7/8"	CALIPER DOBLE PISTON	525
	CARGA	00-00	REP. CIL. MAESTRO Y DE CLUTCH	904086		24.5mm 1"		563
	CARGA	00-01	REP. CIL. MAESTRO Y DE CLUTCH	904086		24.5mm 1"		563
	CARGA	01-11	REP. CIL. MAESTRO Y DE CLUTCH	904086		24.5mm 1"		563
	CARGA	00-01	REPUESTO FRENO DE DISCO	1668	DEL	42.8 mm 1-11/16"	CALIPER DOBLE PISTON	537
	CARGA	00-11	REPUESTO FRENO DE DISCO	2486	DEL	47.6 mm 1-7/8"	CALIPER DOBLE PISTON	542
		02-06	CILINDRO DE CLUTCH	6600		19.0 mm 3/4"	NACIONAL	
		00-01	KIT DE PISTÓN Y REPUESTO FD	742327	DEL	42.8 mm 1-11/16"	CON CALIPER DE DOBLE PISTON	
VERSA		12-14	PISTÓN FRENO DE DISCO	851054	DEL	54.0 mm 2-1/8"		533
		12-14	REPUESTO FRENO DE DISCO	21054	DEL	54.0 mm 2-1/8"		549
		12-14	CILINDRO DE RUEDA	370254	DER	N/D		382
		12-14	CILINDRO DE RUEDA	370254	IZQ	N/D		382
X TERRA		00-04	MANGUERA DE FRENOS	381120	DEL DER	15.48"		434
		00-02	MANGUERA DE FRENOS	381121	DEL IZQ	15.48"		434
		03-04	MANGUERA DE FRENOS	382302	DEL IZQ	18"		454
		00-07	PISTÓN FRENO DE DISCO	85148	DEL	46.4 mm 1-53/64"		519
		00-07	REPUESTO FRENO DE DISCO	2148	DEL	46.4 mm 1-53/64"		540
		03-03	CILINDRO MAESTRO	390867		1"		332
		00-02	CILINDRO MAESTRO	390947		1"		336
		05-05	CILINDRO MAESTRO	390996		1"		338
		05-07	CILINDRO MAESTRO	391096		1"		342
		05-07	CILINDRO MAESTRO	391097		1"		342
		05-07	CILINDRO MAESTRO	391098		1"		342
		00-02	CILINDRO DE CLUTCH	306109Z4		15.8 mm 5/8"		
X-TRAIL		02-10	PISTÓN FRENO DE DISCO	85216	DEL	44.4 mm 1-3/4"	CALIPER DOBLE PISTON	522
		02-10	PISTÓN FRENO DE DISCO	851470	TRAS	34.9 mm 1-3/8"		534
		02-10	REPUESTO FRENO DE DISCO	2216	DEL	44.4 mm 1-3/4"	CALIPER DOBLE PISTON	540
		02-10	REPUESTO FRENO DE DISCO	21470	TRAS	34.9 mm 1-3/8"		551

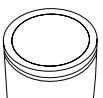



Modelo	Versión	Año	Descripción	Número Lusac	Posición	Diámetro	Notas	Foto Pág.
X-TRAIL		02-07	CILINDRO MAESTRO	39009915		N/D	AUTOMÁTICO	361
		02-10	KIT DE PISTÓN Y REPUESTO FD	742395	TRAS	34.9 mm 1-3/8"		
OLDSMOBILE								
BRAVADA		91-92	CILINDRO DE CLUTCH	37728		20.5 mm	CHOCOLATE	
		91-91	CILINDRO DE CLUTCH	37816		20.6 mm 13/16"	CHOCOLATE	
		98-01	CILINDRO MAESTRO	390427		1"	CILINDRO MAESTRO ESTAMPADO CON KT	313
		00-01	CILINDRO MAESTRO	390571		1"	CILINDRO MAESTRO ESTAMPADO CON DX	319
		02-04	CILINDRO MAESTRO	390697		1"		323
		96-01	MANGUERA DE FRENOS	38871	CTR	18.88"		400
		97-01	MANGUERA DE FRENOS	381065	EXT	11.93"		433
		02-04	MANGUERA DE FRENOS	382616	DER	24.88"		477
CUTLASS		02-04	MANGUERA DE FRENOS	382619	IZQ	13.38"		477
		87-96	MANGUERA DE FRENOS	2025	TRAS DER	8"		385
		87-96	MANGUERA DE FRENOS	2025	TRAS IZQ	8"		385
		87-96	MANGUERA DE FRENOS	4051	DEL IZQ	16 1/16"		386
		87-96	MANGUERA DE FRENOS	4068	DEL DER	17 5/8"		386
		90-96	PISTÓN FRENO DE DISCO	76033	DEL	63.5 mm 2-1/2"		518
		87-89	PISTÓN FRENO DE DISCO	100799	DEL	57.1 mm 2-1/4"		528
		90-96	REPUESTO FRENO DE DISCO	99024	DEL	63.5 mm 2-1/2"		553
		87-89	REPUESTO FRENO DE DISCO	100797	DEL	57.1 mm 2-1/4"		553
	EUROSPORT	87-89	CILINDRO DE RUEDA	104384	DER	17.4 mm 11/16"		372
	EUROSPORT	87-89	CILINDRO DE RUEDA	104384	IZQ	17.4 mm 11/16"		372
	EUROSPORT	93-96	CILINDRO DE RUEDA	112341	DER	22.2 mm 7/8"		373
	EUROSPORT	93-96	CILINDRO DE RUEDA	112341	IZQ	22.2 mm 7/8"		373
	EUROSPORT	90-92	CILINDRO DE RUEDA	0116366	DER	17.4 mm 11/16"		373
	EUROSPORT	90-92	CILINDRO DE RUEDA	0116366	IZQ	17.4 mm 11/16"		373
	EUROSPORT	87-91	CILINDRO MAESTRO	114192		24.0 mm		298
	EUROSPORT	92-93	CILINDRO MAESTRO	114195		24.0 mm		298
	EUROSPORT	94-96	CILINDRO MAESTRO	390179		24mm		302
	EUROSPORT	87-96	MANGUERA DE FRENOS	2025	TRAS DER	8"		385
	EUROSPORT	87-96	MANGUERA DE FRENOS	2025	TRAS IZQ	8"		385
	EUROSPORT	87-96	MANGUERA DE FRENOS	4051	DEL IZQ	16 1/16"		386
	EUROSPORT	87-96	MANGUERA DE FRENOS	4068	DEL DER	17 5/8"		386
	EUROSPORT	90-96	PISTÓN FRENO DE DISCO	76033	DEL	63.5 mm 2-1/2"		518
	EUROSPORT	87-89	PISTÓN FRENO DE DISCO	100799	DEL	57.1 mm 2-1/4"		528
	EUROSPORT	94-96	REP. CIL. MAESTRO Y DE CLUTCH	1831		24.0 mm		557
	EUROSPORT	87-93	REP. CIL. MAESTRO Y DE CLUTCH	114196		24.0 mm		561
	EUROSPORT	90-96	REPUESTO FRENO DE DISCO	99024	DEL	63.5 mm 2-1/2"		553
	EUROSPORT	87-89	REPUESTO FRENO DE DISCO	100797	DEL	57.1 mm 2-1/4"		553
		85-91	CILINDRO DE CLUTCH	360002	INF	31.7 mm 1-1/4"		
		87-89	CILINDRO DE RUEDA	104384	DER	17.4 mm 11/16"		372
		87-89	CILINDRO DE RUEDA	104384	IZQ	17.4 mm 11/16"		372
		93-96	CILINDRO DE RUEDA	112341	DER	22.2 mm 7/8"		373
	93-96	CILINDRO DE RUEDA	112341	IZQ	22.2 mm 7/8"		373	
	90-92	CILINDRO DE RUEDA	0116366	DER	17.4 mm 11/16"		373	





Modelo	Versión	Año	Descripción	Número Lusac	Posición	Diámetro	Notas	Foto Pág.
OLDSMOBILE								
CUTLASS		90-92	CILINDRO DE RUEDA	0116366	IZQ	17.4 mm 11/16"		373
		87-91	CILINDRO MAESTRO	114192		24.0 mm		298
		92-93	CILINDRO MAESTRO	114195		24.0 mm		298
		94-96	CILINDRO MAESTRO	390179		24mm		302
		90-96	KIT DE PISTÓN Y REPUESTO FD	742367	DEL	63.5 mm 2-1/2"		
		94-96	REP. CIL. MAESTRO Y DE CLUTCH	1831		24.0 mm		557
		87-93	REP. CIL. MAESTRO Y DE CLUTCH	114196		24.0 mm		561
	93-96	REPUESTO CILINDRO DE RUEDA	112342		22.2 mm 7/8"			
EUROSPORT		93-96	REPUESTO CILINDRO DE RUEDA	112342		22.2 mm 7/8"		
SILHOUETTE		91-92	MANGUERA DE FRENOS	2025	TRAS IZQ	8"		385
		94-95	MANGUERA DE FRENOS	2025	TRAS IZQ	8"		385
		91-91	MANGUERA DE FRENOS	4068	DEL DER	17 5/8"		386
		91-91	MANGUERA DE FRENOS	38637	DEL IZQ	16.38"		394
		92-92	MANGUERA DE FRENOS	380047	DEL DER	17.16"		405
		94-95	MANGUERA DE FRENOS	380047	DEL DER	17.16"		405
		92-92	MANGUERA DE FRENOS	380048	DEL IZQ	17.16"		405
		94-95	MANGUERA DE FRENOS	380048	DEL IZQ	17.16"		405
		91-91	PISTÓN FRENO DE DISCO	76033	DEL	63.5 mm 2-1/2"		518
		91-92	REPUESTO FRENO DE DISCO	99024	DEL	63.5 mm 2-1/2"		553
		94-95	REPUESTO FRENO DE DISCO	99024	DEL	63.5 mm 2-1/2"		553
		91-91	CILINDRO DE RUEDA	37779	DER	3/4"		366
		91-91	CILINDRO DE RUEDA	37779	IZQ	3/4"		366
		92-92	CILINDRO DE RUEDA	37855	DER	23.8 mm 15/16"		367
		94-95	CILINDRO DE RUEDA	37855	DER	23.8 mm 15/16"		367
		92-92	CILINDRO DE RUEDA	37855	IZQ	23.8 mm 15/16"		367
		94-95	CILINDRO DE RUEDA	37855	IZQ	23.8 mm 15/16"		367
		93-93	CILINDRO DE RUEDA	370190	TRAS IZQ DER	15/16"		381
		96-04	CILINDRO DE RUEDA	370190	TRAS IZQ DER	15/16"		381
		91-91	CILINDRO MAESTRO	39745		24mm	3.1 LTS	
		92-92	CILINDRO MAESTRO	390178		24mm	3.1 LTS	302
		94-95	CILINDRO MAESTRO	390178		24mm	C/ABS 3.8 LTS	302
		00-04	CILINDRO MAESTRO	390401		1"		312
		91-92	KIT DE PISTÓN Y REPUESTO FD	742367	DEL	63.5 mm 2-1/2"		
		94-95	KIT DE PISTÓN Y REPUESTO FD	742367	DEL	63.5 mm 2-1/2"		
		97-04	MANGUERA DE FRENOS	380581	DEL IZQ DER	15.5"		426
		97-04	MANGUERA DE FRENOS	380912	TRAS	7.4"		428
		97-04	MANGUERA DE FRENOS	380913	TRAS	15.33"		429
		02-04	MANGUERA DE FRENOS	382630	IZQ	30.25"	AWD	478
		02-04	MANGUERA DE FRENOS	382631	DER	11.22"	AWD	478
	91-92	REP. CIL. MAESTRO Y DE CLUTCH	114196		24.0 mm		561	
	94-95	REP. CIL. MAESTRO Y DE CLUTCH	114196		24.0 mm		561	
PEUGEOT								
206	INC XR, XT	03-07	PISTÓN FRENO DE DISCO	85860	DEL	54.0 mm 2-1/8"		527

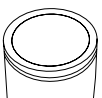



Modelo	Versión	Año	Descripción	Número Lusac	Posición	Diámetro	Notas	Foto Pág.
206	INC XR, XT	03-07	REPUESTO FRENO DE DISCO	2325	TRAS	30.1 mm 1-3/16"	CALIPER DOBLE PISTON (07)	541
	INC XR, XT	03-07	REPUESTO FRENO DE DISCO	2500	DEL	54.0 mm 2-1/8"		542
	INCLUYE XR	00-02	PISTÓN FRENO DE DISCO	85860	DEL	54.0 mm 2-1/8"		527
	INCLUYE XR	00-02	REPUESTO FRENO DE DISCO	2325	TRAS	30.1 mm 1-3/16"		541
	INCLUYE XR	00-02	REPUESTO FRENO DE DISCO	2500	DEL	54.0 mm 2-1/8"		542
	XR	00-02	CILINDRO MAESTRO	390700RL		20.6 mm 13/16"		362
	XR	03-07	PISTÓN FRENO DE DISCO	85860	DEL	54.0 mm 2-1/8"		527
	XR	03-07	REPUESTO FRENO DE DISCO	2325	TRAS	30.1 mm 1-3/16"		541
	XR	03-07	REPUESTO FRENO DE DISCO	2500	DEL	54.0 mm 2-1/8"		542
	XR, XT	03-07	CILINDRO MAESTRO	390700RL		20.6 mm 13/16"		362
	XT	03-07	PISTÓN FRENO DE DISCO	85860	DEL	54.0 mm 2-1/8"		527
	XT	03-08	REPUESTO FRENO DE DISCO	2325	TRAS	30.1 mm 1-3/16"		541
	XT	03-08	REPUESTO FRENO DE DISCO	2500	DEL	54.0 mm 2-1/8"		542
		00-09	CILINDRO DE RUEDA	3700928	TRAS DER	20.64 mm 13/16		
		00-09	CILINDRO DE RUEDA	3700929	TRAS IZQ	20.64 mm 13/16		
307		03-07	PISTÓN FRENO DE DISCO	85860	DEL	54.0 mm 2-1/8"		527
		03-07	REPUESTO FRENO DE DISCO	2103	TRAS	38.1 mm 1-1/2"		539
		03-07	REPUESTO FRENO DE DISCO	2500	DEL	54.0 mm 2-1/8"		542
PARTNER		04-09	PISTÓN FRENO DE DISCO	85860	DEL	54.0 mm 2-1/8"		527
		04-09	REPUESTO FRENO DE DISCO	1449	DEL	54.0 mm 2-1/8"		537
		04-09	CILINDRO DE RUEDA	3700913	DER	22.2 mm 7/8"		384
		04-09	CILINDRO DE RUEDA	3700913	IZQ	22.2 mm 7/8"		384
		04-08	KIT DE PISTÓN Y REPUESTO FD	742389	DEL	54.0 mm 2-1/8"		
PLYMOUTH								
BREEZE		96-96	KIT DE PISTÓN Y REPUESTO FD	742375	DEL	54.0 mm 2-1/8"		
PONTIAC								
AZTEK		01-05	MANGUERA DE FRENOS	381458	TRAS DER	8.15"		446
		01-05	MANGUERA DE FRENOS	381458	TRAS IZQ	8.15"		446
		01-05	MANGUERA DE FRENOS	381534	DEL DER	13.63"		448
		01-05	MANGUERA DE FRENOS	381534	DEL IZQ	13.63"		448
		01-05	PISTÓN FRENO DE DISCO	85152	DEL	64.0 mm		519
		01-05	PISTÓN FRENO DE DISCO	85476	TRAS	38.1 mm 1-1/2"		525
		01-05	REPUESTO FRENO DE DISCO	1759	TRAS	38.1 mm 1-1/2"		
		01-05	REPUESTO FRENO DE DISCO	2476	TRAS	38.1 mm 1-1/2"		
		01-05	REPUESTO FRENO DE DISCO	21160	DEL	64.0 mm		550
		01-05	CILINDRO DE RUEDA	370117	DER	7/8"		377
		01-05	CILINDRO DE RUEDA	370117	IZQ	7/8"		377
		01-05	KIT DE PISTÓN Y REPUESTO FD	742396	TRAS	38.1 mm 1-1/2"	4X4	





Modelo	Versión	Año	Descripción	Número Lusac	Posición	Diámetro	Notas	Foto Pág.
PONTIAC								
BONNEVILLE		94-99	MANGUERA DE FRENOS	38951	TRAS DER	12.5"		402
		94-99	MANGUERA DE FRENOS	38951	TRAS IZQ	12.5"		402
		94-99	MANGUERA DE FRENOS	380261	DEL IZQ	18.25"		410
		94-99	MANGUERA DE FRENOS	380271	DEL DER	12.5"		411
		94-99	REPUESTO FRENO DE DISCO	99024	DEL	63.5 mm 2-1/2"		553
		94-95	CILINDRO DE RUEDA	37855	DER	23.8 mm 15/16"		367
		94-95	CILINDRO DE RUEDA	37855	IZQ	23.8 mm 15/16"		367
		96-99	CILINDRO DE RUEDA	112341	DER	22.2 mm 7/8"		373
		96-99	CILINDRO DE RUEDA	112341	IZQ	22.2 mm 7/8"		373
		94-95	CILINDRO MAESTRO	390186		1"		303
		96-99	CILINDRO MAESTRO	390267		1"		306
	96-96	REPUESTO CILINDRO DE RUEDA	112342		22.2 mm 7/8"			
FIREBIRD		94-97	MANGUERA DE FRENOS	380406	DEL DER	12.5"		419
		94-97	MANGUERA DE FRENOS	380406	DEL IZQ	12.5"		419
		94-01	MANGUERA DE FRENOS	380483	TRAS DER	7.75"		422
		94-01	MANGUERA DE FRENOS	380483	TRAS IZQ	7.75"		422
		98-01	PISTÓN FRENO DE DISCO	85275	DEL	45.0 mm	CALIPER DOBLE PISTON	522
		98-01	PISTÓN FRENO DE DISCO	85488	TRAS	45.0 mm		525
		98-01	REPUESTO FRENO DE DISCO	2275	DEL	45.0 mm	CALIPER DOBLE PISTON	541
		94-97	REPUESTO FRENO DE DISCO	99024	DEL	63.5 mm 2-1/2"		553
		94-97	CILINDRO DE RUEDA	37973	DER	13/16"		369
		94-97	CILINDRO DE RUEDA	37973	IZQ	13/16"		369
	94-97	CILINDRO MAESTRO	390214		1"		303	
FIREBIRD TRANS AM		94-01	CILINDRO DE CLUTCH	350014		19.0 mm 3/4"		
		98-01	MANGUERA DE FRENOS	380289	TRAS IZQ	11.75"		411
G3		06-09	MANGUERA DE FRENOS	381621	TRAS IZQ	9"		451
		06-09	MANGUERA DE FRENOS	382507	DEL DER	14 1/16"		468
		06-09	MANGUERA DE FRENOS	382507	DEL IZQ	14 1/16"		468
		06-09	CILINDRO DE RUEDA	370103	DER	13/16"		376
		06-09	CILINDRO DE RUEDA	370103	IZQ	13/16"		376
		06-08	CILINDRO MAESTRO	390881		7/8"	C/ABS, TRANSMISIÓN ESTÁNDARDD	333
		06-08	CILINDRO MAESTRO	390888		7/8"	S/ABS TRANSMISIÓN AUTOMÁTICA	333
		09-09	CILINDRO MAESTRO	391170		7/8"	S/ABS TRANSMISIÓN AUTOMÁTICA	346
		09-10	CILINDRO MAESTRO	391331		7/8"	C/ABS, TRANSMISIÓN AUTOMÁTICA	355
		09-09	CILINDRO MAESTRO	391332		7/8"	C/ABS, TRANSMISIÓN ESTÁNDARDD	355
		09-09	CILINDRO MAESTRO	391333		7/8"	S/ABS TRANSMISIÓN ESTÁNDARDD	356
G4		05-06	MANGUERA DE FRENOS	381634	TRAS IZQ	9.7"		451
		05-06	PISTÓN FRENO DE DISCO	851034	DEL	54.0 mm 2-1/8"		532
		05-06	REPUESTO FRENO DE DISCO	21034	DEL	54.0 mm 2-1/8"		548
		05-06	CILINDRO MAESTRO	390981		7/8"	ESTÁNDAR	337
		05-06	CILINDRO MAESTRO	390985		7/8"	AUTOMÁTICO	338
		05-06	KIT DE PISTÓN Y REPUESTO FD	742427	DEL	54.0 mm 2-1/8"		
G5		07-09	MANGUERA DE FRENOS	381634	DEL IZQ	9.7"		451

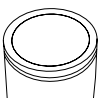



Modelo	Versión	Año	Descripción	Número Lusac	Posición	Diámetro	Notas	Foto Pág.
G5		07-09	MANGUERA DE FRENOS	381634	TRAS IZQ	9.7"		451
		07-09	PISTÓN FRENO DE DISCO	851013	DEL	54.0 mm 2-1/8"		531
		07-09	REPUESTO FRENO DE DISCO	21013	DEL	54.0 mm 2-1/8"		546
	SEDAN, LS	07-09	CILINDRO MAESTRO	390981		7/8"	ESTÁNDAR	337
	SEDAN, LS	07-09	CILINDRO MAESTRO	390985		7/8"	AUTOMÁTICO	338
		07-09	KIT DE PISTÓN Y REPUESTO FD	742418	DEL	54.0 mm 2-1/8"		
G6		05-09	MANGUERA DE FRENOS	382508	TRAS DER	14"		468
		05-09	MANGUERA DE FRENOS	382508	TRAS IZQ	14"		468
		05-09	MANGUERA DE FRENOS	382677	DEL DER	16"		481
		05-09	MANGUERA DE FRENOS	382678	DEL IZQ	15.25"		481
		05-09	PISTÓN FRENO DE DISCO	851013	DEL	54.0 mm 2-1/8"		531
		05-09	REPUESTO FRENO DE DISCO	21013	DEL	54.0 mm 2-1/8"		546
		07-07	CILINDRO MAESTRO	390885		23.8 mm 15/16"	S/C DE ESTABILIDAD	
		05-06	CILINDRO MAESTRO	390885		23.8 mm 15/16"		
		05-07	CILINDRO MAESTRO	390933		15/16"		336
		05-07	CILINDRO MAESTRO	390985		7/8"	AUTOMÁTICO	338
		08-08	CILINDRO MAESTRO	391185		15/16"		347
		09-09	CILINDRO MAESTRO	391186		15/16"		347
GRAND AM		05-09	KIT DE PISTÓN Y REPUESTO FD	742418	DEL	54.0 mm 2-1/8"		
		99-04	MANGUERA DE FRENOS	380467	DEL DER	12.5"		421
		99-04	MANGUERA DE FRENOS	380467	DEL IZQ	12.5"		421
		99-04	MANGUERA DE FRENOS	380580	TRAS IZQ	10.75"		426
		99-00	MANGUERA DE FRENOS	380580	TRAS IZQ	10.75"	DS GT	426
		99-05	PISTÓN FRENO DE DISCO	853940	DEL	60.3 mm 2-3/8"		535
		99-05	REPUESTO FRENO DE DISCO	2394	DEL	60.3 mm 2-3/8"		541
		99-05	REPUESTO FRENO DE DISCO	2493	TRAS	38.1 mm 1-1/2"		542
		02-04	CILINDRO DE CLUTCH	360111		N.R.		
		99-05	CILINDRO DE RUEDA	370055	DER	7/8"		375
		99-05	CILINDRO DE RUEDA	370055	IZQ	7/8"		375
		99-00	CILINDRO MAESTRO	390386		1"		311
		01-05	CILINDRO MAESTRO	390676		24mm		322
		99-00	REP. CIL. MAESTRO Y DE CLUTCH	90386		25.4 mm 1"		559
GRAND PRIX		97-98	MANGUERA DE FRENOS	380580	TRAS DER	10.75"		426
		97-98	MANGUERA DE FRENOS	380580	TRAS IZQ	10.75"		426
		97-01	MANGUERA DE FRENOS	380581	DEL DER	15.5"		426
		97-01	MANGUERA DE FRENOS	380581	DEL IZQ	15.5"		426
		99-01	MANGUERA DE FRENOS	381271	TRAS DER	10.88"		439
		99-01	MANGUERA DE FRENOS	381271	TRAS IZQ	10.88"		439
		97-01	PISTÓN FRENO DE DISCO	85088	DEL	63.5 mm 2-1/2"		519
		97-01	PISTÓN FRENO DE DISCO	85476	TRAS	38.1 mm 1-1/2"		525
		97-01	REPUESTO FRENO DE DISCO	1759	TRAS	38.1 mm 1-1/2"		
		97-01	REPUESTO FRENO DE DISCO	2476	TRAS	38.1 mm 1-1/2"		
		97-01	REPUESTO FRENO DE DISCO	99024	DEL	63.5 mm 2-1/2"		553
	GT, GTP, SE	97-98	CILINDRO MAESTRO	390176		24mm		302

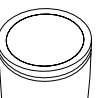



Modelo	Versión	Año	Descripción	Número Lusac	Posición	Diámetro	Notas	Foto Pág.
PONTIAC								
MONTANA	GT, GTP, SE	99-01	CILINDRO MAESTRO	390401		1"		312
		97-01	KIT DE PISTÓN Y REPUESTO FD	742396	TRAS	38.1 mm 1-1/2"		
		05-05	MANGUERA DE FRENOS	380483	TRAS DER	7.75"		422
		05-05	MANGUERA DE FRENOS	380581	DEL DER	15.5"		426
		05-05	MANGUERA DE FRENOS	380581	DEL IZQ	15.5"		426
		05-09	MANGUERA DE FRENOS	382591	TRAS IZQ	13.5"		475
		05-09	PISTÓN FRENO DE DISCO	85088	DEL	63.5 mm 2-1/2"		519
		05-07	PISTÓN FRENO DE DISCO	85476	TRAS	38.1 mm 1-1/2"		525
		05-07	REPUESTO FRENO DE DISCO	2476	TRAS	38.1 mm 1-1/2"		
		05-09	REPUESTO FRENO DE DISCO	99024	DEL	63.5 mm 2-1/2"		553
	SV6	05-06	CILINDRO MAESTRO	391010		1"		339
	SV6	05-06	MANGUERA DE FRENOS	382591	IZQ	13.5"	S/SUSPENSIÓN TRASERA INDEPENDIENTE	475
		99-05	CILINDRO DE RUEDA	370190	TRAS IZQ DER	15/16"		381
		00-05	CILINDRO MAESTRO	390401		1"		312
		05-09	CILINDRO MAESTRO	391010		1"		339
		05-07	KIT DE PISTÓN Y REPUESTO FD	742396	TRAS	38.1 mm 1-1/2"		
		99-04	MANGUERA DE FRENOS	380581	DEL IZQ DER	15.5"		426
		99-04	MANGUERA DE FRENOS	380912	TRAS	7.4"		428
		99-04	MANGUERA DE FRENOS	380913	TRAS	15.33"		429
		02-04	MANGUERA DE FRENOS	382630	IZQ	30.25"	AWD	478
	02-04	MANGUERA DE FRENOS	382631	DER	11.22"	AWD	478	
SOLSTICE		06-09	MANGUERA DE FRENOS	382590	DEL DER	15.75"		475
		06-09	MANGUERA DE FRENOS	382590	DEL IZQ	15.75"		475
		06-09	PISTÓN FRENO DE DISCO	851051	N/D	N/D		533
		06-09	REPUESTO FRENO DE DISCO	642	DEL	60.3 mm 2-3/8"		536
SUNFIRE		97-02	MANGUERA DE FRENOS	38081	TRAS DER	7.5"		388
		04-05	MANGUERA DE FRENOS	38081	TRAS DER	7.5"		388
		97-02	MANGUERA DE FRENOS	38081	TRAS IZQ	7.5"		388
		04-05	MANGUERA DE FRENOS	38081	TRAS IZQ	7.5"		388
		97-02	MANGUERA DE FRENOS	380467	DEL DER	12.5"		421
		04-05	MANGUERA DE FRENOS	380467	DEL DER	12.5"		421
		97-02	MANGUERA DE FRENOS	380467	DEL IZQ	12.5"		421
		04-05	MANGUERA DE FRENOS	380467	DEL IZQ	12.5"		421
		97-02	PISTÓN FRENO DE DISCO	85389	DEL	57.1 mm 2-1/4"		523
		04-05	PISTÓN FRENO DE DISCO	85389	DEL	57.1 mm 2-1/4"		523
		97-02	REPUESTO FRENO DE DISCO	100797	DEL	57.1 mm 2-1/4"		553
		04-05	REPUESTO FRENO DE DISCO	100797	DEL	57.1 mm 2-1/4"		553
		02-02	CILINDRO DE CLUTCH	360111		N.R.	NACIONAL	
		95-02	CILINDRO DE RUEDA	0116366	DER	17.4 mm 11/16"		373
		97-02	CILINDRO DE RUEDA	0116366	IZQ	17.4 mm 11/16"		373
		03-05	CILINDRO DE RUEDA	370133	TRAS IZQ DER	11/16"		378
	97-99	CILINDRO MAESTRO	390277		7/8"		307	
	00-05	CILINDRO MAESTRO	390646		7/8"		321	



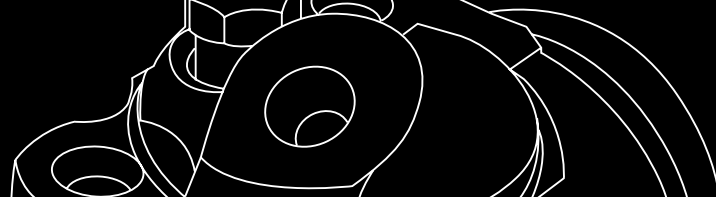

Modelo	Versión	Año	Descripción	Número Lusac	Posición	Diámetro	Notas	Foto Pág.
SUNFIRE		95-96	MANGUERA DE FRENOS	38081	TRAS IZQ DER	7.5"		388
		03-03	MANGUERA DE FRENOS	38081	TRAS IZQ DER	7.5"	FABRICADOS EN USA	388
		95-96	MANGUERA DE FRENOS	380467	DEL IZQ DER	12.5"		421
		03-03	MANGUERA DE FRENOS	380467	DEL IZQ DER	12.5"		421
		97-02	REP. CIL. MAESTRO Y DE CLUTCH	114191		22.2 mm 7/8"		561
		04-05	REP. CIL. MAESTRO Y DE CLUTCH	114191		22.2 mm 7/8"		561
TORRENT		06-09	MANGUERA DE FRENOS	381639	TRAS IZQ	10.87"		452
		06-09	MANGUERA DE FRENOS	381640	TRAS DER	10.87"		452
		06-09	MANGUERA DE FRENOS	382700	DEL IZQ	18.81"		483
		06-09	MANGUERA DE FRENOS	382701	DEL DER	18.81"		483
		06-06	PISTÓN FRENO DE DISCO	85088	DEL	63.5 mm 2-1/2"		519
		06-06	PISTÓN FRENO DE DISCO	85476	TRAS	38.1 mm 1-1/2"		525
		06-06	REPUESTO FRENO DE DISCO	2476	TRAS	38.1 mm 1-1/2"		
		06-06	REPUESTO FRENO DE DISCO	99024	DEL	63.5 mm 2-1/2"		553
		06-06	CILINDRO DE RUEDA	370130	DER	7/8"		377
		06-06	CILINDRO DE RUEDA	370130	IZQ	7/8"		377
		06-09	CILINDRO MAESTRO	390739		1"		325
		07-09	CILINDRO MAESTRO	391145		1"		344
TRANS-AM		94-97	MANGUERA DE FRENOS	380406	DEL DER	12.5"		419
		94-97	MANGUERA DE FRENOS	380406	DEL IZQ	12.5"		419
		94-01	MANGUERA DE FRENOS	380483	TRAS DER	7.75"		422
		94-01	MANGUERA DE FRENOS	380483	TRAS IZQ	7.75"		422
		98-01	PISTÓN FRENO DE DISCO	85275	DEL	45.0 mm	CALIPER DOBLE PISTON	522
		98-01	PISTÓN FRENO DE DISCO	85488	TRAS	45.0 mm		525
		98-01	REPUESTO FRENO DE DISCO	2275	DEL	45.0 mm	CALIPER DOBLE PISTON	541
		94-97	REPUESTO FRENO DE DISCO	99024	DEL	63.5 mm 2-1/2"		553
		94-97	CILINDRO DE RUEDA	37973	DER	13/16"		369
		94-97	CILINDRO DE RUEDA	37973	IZQ	13/16"		369
	94-97	CILINDRO MAESTRO	390214		1"		303	
PORSCHE								
911	CARRERA	97-98	CILINDRO MAESTRO	390636		15/16"	S/C DE TRACCIÓN	321
	CARRERA	98-06	CILINDRO MAESTRO	390636		15/16"	S/C DE TRACCIÓN	321
RENAULT								
ALLIANCE		84-86	MANGUERA DE FRENOS	38258	DEL DER	15.5"		
		84-86	MANGUERA DE FRENOS	38258	DEL IZQ	15.5"		
		84-86	CILINDRO DE RUEDA	37573	DER	13/16"		
		84-86	CILINDRO DE RUEDA	37573	IZQ	13/16"		
		84-86	REP. CIL. MAESTRO Y DE CLUTCH	471		21.0 mm 53/64"		
CLIO		02-10	PISTÓN FRENO DE DISCO	85215	DEL	48.0 mm 1-57/64"		522
		02-10	REPUESTO FRENO DE DISCO	2215	DEL	48.0 mm 1-57/64"		540
	ENERGY	07-07	CILINDRO MAESTRO	4601000Q		20.6 mm 13/16"	SEDAN 1.6 LTS	362
	ENERGY	07-07	PISTÓN FRENO DE DISCO	85215	DEL	48.0 mm 1-57/64"		522





Modelo	Versión	Año	Descripción	Número Lusac	Posición	Diámetro	Notas	Foto Pág.
RENAULT								
CLIO	ENERGY	07-07	REP. CIL. MAESTRO Y DE CLUTCH	904080		20.6 mm 13/16"		562
	ENERGY	07-07	REPUESTO FRENO DE DISCO	2215	DEL	48.0 mm 1-57/64"		540
	EXPRES- SION	04-08	CILINDRO MAESTRO	4601000Q		20.6 mm 13/16"		362
	EXPRES- SION	04-08	PISTÓN FRENO DE DISCO	85215	DEL	48.0 mm 1-57/64"		522
	EXPRES- SION	04-08	REP. CIL. MAESTRO Y DE CLUTCH	904080		20.6 mm 13/16"		562
	EXPRES- SION	04-08	REPUESTO FRENO DE DISCO	2215	DEL	48.0 mm 1-57/64"		540
	SPORT	02-04	PISTÓN FRENO DE DISCO	85215	DEL	48.0 mm 1-57/64"		522
	SPORT	02-04	REPUESTO FRENO DE DISCO	2215	DEL	48.0 mm 1-57/64"		540
		02-08	CILINDRO DE RUEDA	4410000Q	IZQ	17.4 mm 11/16"		
		02-08	CILINDRO DE RUEDA	4410000Q	DER	17.4 mm 11/16"		
		02-10	CILINDRO MAESTRO	4601000Q		20.6 mm 13/16"		362
		02-10	KIT DE PISTÓN Y REPUESTO FD	742423	DEL	48.0 mm 1-57/64"		
		02-10	REP. CIL. MAESTRO Y DE CLUTCH	904080		20.6 mm 13/16"		562
ENCORE		85-86	MANGUERA DE FRENOS	38258	DEL DER	15.5"		
		85-86	MANGUERA DE FRENOS	38258	DEL IZQ	15.5"		
		85-86	CILINDRO DE RUEDA	37573	DER	13/16"		
		85-86	CILINDRO DE RUEDA	37573	IZQ	13/16"		
		85-86	REP. CIL. MAESTRO Y DE CLUTCH	471		21.0 mm 53/64"		
EURO CLIO	AUTEN- TIQUE	07-08	PISTÓN FRENO DE DISCO	85215	DEL	48.0 mm 1-57/64"		522
	AUTEN- TIQUE	07-08	REPUESTO FRENO DE DISCO	2215	DEL	48.0 mm 1-57/64"		540
KANGOO	EXPRESS	04-10	CILINDRO DE RUEDA	3700912	DER	22.2 mm 7/8"		383
	EXPRESS	04-10	CILINDRO DE RUEDA	3700912	IZQ	22.2 mm 7/8"		383
	EXPRESS	04-10	PISTÓN FRENO DE DISCO	851050	DEL	54.0 mm 2-1/8"		
	EXPRESS	04-10	REPUESTO FRENO DE DISCO	2500	DEL	54.0 mm 2-1/8"		542
MASCOTT		06-09	KIT DE PISTÓN Y REPUESTO FD	742434	DEL	52.0 mm 2-3/64"		
MEGANE	II	03-06	PISTÓN FRENO DE DISCO	85860	DEL	54.0 mm 2-1/8"		527
	II	08-10	PISTÓN FRENO DE DISCO	85860	DEL	54.0 mm 2-1/8"		527
	II	04-06	REPUESTO FRENO DE DISCO	1449	DEL	54.0 mm 2-1/8"		537
	II	08-10	REPUESTO FRENO DE DISCO	1449	DEL	54.0 mm 2-1/8"		537
	II	03-10	REPUESTO FRENO DE DISCO	2325	TRAS	30.1 mm 1-3/16"		541
	II	03-10	REPUESTO FRENO DE DISCO	2500	DEL	54.0 mm 2-1/8"		542
	II COUPE CONVER- TIBLE	05-07	PISTÓN FRENO DE DISCO	85860	DEL	54.0 mm 2-1/8"		527
	II COUPE CONVER- TIBLE	05-07	REPUESTO FRENO DE DISCO	1449	DEL	54.0 mm 2-1/8"		537
	II SEDAN	04-07	PISTÓN FRENO DE DISCO	85860	DEL	54.0 mm 2-1/8"		527

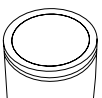



Modelo	Versión	Año	Descripción	Número Lusac	Posición	Diámetro	Notas	Foto Pág.
MEGANE	II SEDAN	04-07	REPUESTO FRENO DE DISCO	1449	DEL	54.0 mm 2-1/8"		537
	II SEDAN	04-07	REPUESTO FRENO DE DISCO	2325	TRAS	30.1 mm 1-3/16"		541
	II SPORT	07-07	PISTÓN FRENO DE DISCO	85860	DEL	54.0 mm 2-1/8"		527
	II SPORT	07-07	REPUESTO FRENO DE DISCO	1449	DEL	54.0 mm 2-1/8"		537
	II, INC SEDAN, SPORT, COUPE, CONVERTIBLE	07-07	PISTÓN FRENO DE DISCO	85860	DEL	54.0 mm 2-1/8"		527
	II, INC SEDAN, SPORT, COUPE, CONVERTIBLE	07-07	REPUESTO FRENO DE DISCO	1449	DEL	54.0 mm 2-1/8"		537
		01-07	KIT DE PISTÓN Y REPUESTO FD	742389	DEL	54.0 mm 2-1/8"		
		01-03	PISTÓN FRENO DE DISCO	85860	DEL	54.0 mm 2-1/8"		527
		01-03	REPUESTO FRENO DE DISCO	1449	DEL	54.0 mm 2-1/8"		537
R-18		84-86	PISTÓN FRENO DE DISCO	4019	DEL	48.0 mm 1-57/64"		
		84-84	REPUESTO FRENO DE DISCO	447	DEL	48.0 mm 1-57/64"	CALIPER GIRLING	
R-5		81-85	MANGUERA DE FRENOS	6037	DEL DER	N/D		
		81-85	MANGUERA DE FRENOS	6037	DEL IZQ	N/D		
		81-85	PISTÓN FRENO DE DISCO	4005	DEL	45.0 mm		
		81-85	REPUESTO FRENO DE DISCO	445	DEL	45.0 mm		
		81-85	REP. CIL. MAESTRO Y DE CLUTCH	490		19.0 mm 3/4"		
SANDERO		10-12	KIT DE PISTÓN Y REPUESTO FD	742406	DEL	48.0 mm 1-57/64"		
		10-12	PISTÓN FRENO DE DISCO	85215	DEL	48.0 mm 1-57/64"		522
		10-12	REPUESTO FRENO DE DISCO	124	DEL	48.0 mm 1-57/64"		536
SCENIC	II	06-09	PISTÓN FRENO DE DISCO	85860	DEL	54.0 mm 2-1/8"		527
	II	06-09	REPUESTO FRENO DE DISCO	1449	DEL	54.0 mm 2-1/8"		537
	II	06-09	REPUESTO FRENO DE DISCO	2048	TRAS	34.0 mm		539
		01-09	KIT DE PISTÓN Y REPUESTO FD	742389	DEL	54.0 mm 2-1/8"		
		01-09	PISTÓN FRENO DE DISCO	85860	DEL	54.0 mm 2-1/8"		527
		01-09	REPUESTO FRENO DE DISCO	1449	DEL	54.0 mm 2-1/8"		537
		01-09	REPUESTO FRENO DE DISCO	2048	TRAS	34.0 mm		539
TRAFIC		07-09	PISTÓN FRENO DE DISCO	85860	DEL	54.0 mm 2-1/8"		527
		07-09	REPUESTO FRENO DE DISCO	2500	DEL	54.0 mm 2-1/8"		542
SAAB								
9-3		99-03	MANGUERA DE FRENOS	38657	DEL DER	13.75"		395
		01-03	MANGUERA DE FRENOS	38657	DEL IZQ	13.75"		395





Modelo	Versión	Año	Descripción	Número Lusac	Posición	Diámetro	Notas	Foto Pág.
SAAB								
9-3		01-03	MANGUERA DE FRENOS	380552	TRAS DER	9.25"		425
		01-03	MANGUERA DE FRENOS	380552	TRAS IZQ	9.25"		425
		01-03	MANGUERA DE FRENOS	381136	TRAS IZQ	10.88"		435
		06-09	CILINDRO MAESTRO	93172089		25.4 mm 1"		361
		99-00	MANGUERA DE FRENOS	380552	DER	9.25"		425
		99-00	MANGUERA DE FRENOS	381136	IZQ	10.88"		435
9-5		10-11	CILINDRO MAESTRO	391154		1"		345
SATURN								
TODOS		91-02	MANGUERA DE FRENOS	38884	DEL DER	17.63"	CHOCOLATE	400
VUE		02-05	CILINDRO DE CLUTCH	360111		N.R.	CHOCOLATE	
SEAT								
ALHAMBRA		02-03	KIT DE PISTÓN Y REPUESTO FD	742391	DEL	54.0 mm 2-1/8"		
		02-03	KIT DE PISTÓN Y REPUESTO FD	742393	DEL	54.0 mm 2-1/8"		
		02-03	PISTÓN FRENO DE DISCO	2902	DEL	54.0 mm 2-1/8"		517
		02-03	PISTÓN FRENO DE DISCO	85860	DEL	54.0 mm 2-1/8"		527
		02-03	REPUESTO FRENO DE DISCO	1449	DEL	54.0 mm 2-1/8"		537
		02-03	REPUESTO FRENO DE DISCO	2103	TRAS	38.1 mm 1-1/2"		539
		02-03	REPUESTO FRENO DE DISCO	2801	DEL	54.0 mm 2-1/8"		
CORDOBA		01-09	PISTÓN FRENO DE DISCO	2902	DEL	54.0 mm 2-1/8"		517
		03-09	PISTÓN FRENO DE DISCO	85860	DEL	54.0 mm 2-1/8"		527
		01-09	REPUESTO FRENO DE DISCO	1449	DEL	54.0 mm 2-1/8"		537
		01-09	REPUESTO FRENO DE DISCO	2048	TRAS	34.0 mm		539
		01-09	REPUESTO FRENO DE DISCO	2103	TRAS	38.1 mm 1-1/2"		539
		01-06	CILINDRO DE RUEDA	37986	DER	3/4"		369
		01-06	CILINDRO DE RUEDA	37986	IZQ	3/4"		369
		01-09	CILINDRO MAESTRO	390921RL		22.2 mm 7/8"		362
IBIZA		01-09	PISTÓN FRENO DE DISCO	2902	DEL	54.0 mm 2-1/8"		517
		01-09	PISTÓN FRENO DE DISCO	85860	DEL	54.0 mm 2-1/8"		527
		01-09	REPUESTO FRENO DE DISCO	1449	DEL	54.0 mm 2-1/8"		537
		01-09	REPUESTO FRENO DE DISCO	2048	TRAS	34.0 mm		539
		01-09	REPUESTO FRENO DE DISCO	2103	TRAS	38.1 mm 1-1/2"	CALIPER LUCAS	539
		01-07	CILINDRO DE RUEDA	37986	DER	3/4"		369
		01-07	CILINDRO DE RUEDA	37986	IZQ	3/4"		369
		05-09	CILINDRO MAESTRO	390060		13/16"		300
		01-02	CILINDRO MAESTRO	390271		7/8"		307
		01-09	CILINDRO MAESTRO	390911RL		20.6 mm 13/16"		362
		01-09	KIT DE PISTÓN Y REPUESTO FD	742389	DEL	54.0 mm 2-1/8"		
		01-08	KIT DE PISTÓN Y REPUESTO FD	742393	DEL	54.0 mm 2-1/8"		
LEON		01-09	PISTÓN FRENO DE DISCO	2902	DEL	54.0 mm 2-1/8"		517





Modelo	Versión	Año	Descripción	Número Lusac	Posición	Diámetro	Notas	Foto Pág.
LEON		01-09	REPUESTO FRENO DE DISCO	1449	DEL	54.0 mm 2-1/8"		537
		01-07	CILINDRO MAESTRO	390921RL		22.2 mm 7/8"	TURBO 1.8 LTS	362
		03-10	KIT DE PISTÓN Y REPUESTO FD	742393	DEL	54.0 mm 2-1/8"		
TOLEDO		01-06	PISTÓN FRENO DE DISCO	2902	DEL	54.0 mm 2-1/8"		517
		01-03	PISTÓN FRENO DE DISCO	85860	DEL	54.0 mm 2-1/8"		527
		01-06	REPUESTO FRENO DE DISCO	1449	DEL	54.0 mm 2-1/8"		537
		01-03	REPUESTO FRENO DE DISCO	2103	TRAS	38.1 mm 1-1/2"		539
	TURBO	01-05	CILINDRO MAESTRO	390060		13/16"		300
	TURBO	01-05	CILINDRO MAESTRO	390911RL		20.6 mm 13/16"	4CIL 1.8 LTS, TURBO	362
	TURBO	01-05	PISTÓN FRENO DE DISCO	2902	DEL	54.0 mm 2-1/8"		517
	TURBO	01-05	REPUESTO FRENO DE DISCO	1449	DEL	54.0 mm 2-1/8"		537
		01-06	CILINDRO MAESTRO	390060		13/16"		300
		01-06	CILINDRO MAESTRO	390911RL		20.6 mm 13/16"	1.8 LTS	362
		01-03	KIT DE PISTÓN Y REPUESTO FD	742389	DEL	54.0 mm 2-1/8"		
	01-03	KIT DE PISTÓN Y REPUESTO FD	742393	DEL	54.0 mm 2-1/8"			
SUBARU								
FORESTER		09-13	CILINDRO MAESTRO	391324		15/16"		355
		03-08	MANGUERA DE FRENOS	381350	DER	21.35"		443
IMPREZA		07-14	CILINDRO MAESTRO	391324		15/16"		355
LEGACY	2.5 GT	07-09	CILINDRO MAESTRO	391324		15/16"		355
	2.5 GT	99-05	MANGUERA DE FRENOS	381349	INT	10.85"		443
	2.5 GT	99-01	MANGUERA DE FRENOS	381350	DER	21.35"	DISCO-DISCO	443
	2.5 GT	99-10	MANGUERA DE FRENOS	381351	DEL DER	19.75"	DISCO-TAMBOR	443
	2.5 GT	99-01	MANGUERA DE FRENOS	381352	IZQ	21.35"	DISCO-DISCO	443
	2.5 GT	99-10	MANGUERA DE FRENOS	381353	DEL IZQ	19.75"	DISCO-TAMBOR	443
	2.5 GT	02-05	MANGUERA DE FRENOS	381388	EXT	11.6"		445
	2.5 GT	99-01	MANGUERA DE FRENOS	381388	EXT	11.6"	DISCO-DISCO	445
		05-09	CILINDRO MAESTRO	391324		15/16"		355
		00-10	MANGUERA DE FRENOS	381350	DEL DER	21.35"		443
		00-10	MANGUERA DE FRENOS	381352	DEL IZQ	21.35"		443
		00-04	MANGUERA DE FRENOS	381388	EXT	11.6"		445
		05-05	MANGUERA DE FRENOS	382648	INT	12.44"		479
		05-10	MANGUERA DE FRENOS	382649	TRAS IZQ	11.19"		479
	05-10	MANGUERA DE FRENOS	382650	TRAS DER	11.19"		479	
SUZUKI								
AERIO	GL, GLS	06-07	CILINDRO DE RUEDA	37962	DER	11/16"		368
ESTEEM		96-02	CILINDRO DE RUEDA	37962	IZQ	11/16"		368
GRAND VITARA	GL, GLS	06-11	CILINDRO DE RUEDA	370153	IZQ	7/8"		379
	GL, GLS	06-11	CILINDRO DE RUEDA	370159	DER	7/8"		379
		99-05	CILINDRO DE RUEDA	370153	IZQ	7/8"		379
		99-05	CILINDRO DE RUEDA	370159	DER	7/8"		379
		06-11	CILINDRO MAESTRO	391215		15/16"	TRANSMISIÓN AUTOMÁTICA	350
		06-11	CILINDRO MAESTRO	391216		23.8 mm 15/16"	MANUAL	350
		06-10	KIT DE PISTÓN Y REPUESTO FD	742302	DEL	57.1 mm 2-1/4"		
		06-12	KIT DE PISTÓN Y REPUESTO FD	742428	DEL	60.3 mm 2-3/8"	DISCO DISCO	





Modelo	Versión	Año	Descripción	Número Lusac	Posición	Diámetro	Notas	Foto Pág.
SUZUKI								
GRAND VITARA		06-08	MANGUERA DE FRENOS	38618	TRAS IZQ DER	11.94"		393
		06-11	REPUESTO FRENO DE DISCO	1458	DEL	57.1 mm 2-1/4"		537
		06-12	REPUESTO FRENO DE DISCO	21036	DEL	60.3 mm 2-3/8"	DISCO DISCO	548
SWIFT	SWIFT+	04-10	CILINDRO DE RUEDA	370103	TRAS IZQ DER	13/16"		376
		07-09	KIT DE PISTÓN Y REPUESTO FD	742416	DEL	54.0 mm 2-1/8"		
		95-01	MANGUERA DE FRENOS	38672	TRAS	14.5"		
		95-01	MANGUERA DE FRENOS	38985	DEL IZQ DER	18"		
SX4		07-09	KIT DE PISTÓN Y REPUESTO FD	742302	DEL	57.1 mm 2-1/4"		
		07-11	MANGUERA DE FRENOS	382651	DEL DER	16.54"		479
		07-11	MANGUERA DE FRENOS	382651	DEL IZQ	16.54"		479
		08-10	REPUESTO FRENO DE DISCO	1458	DEL	57.1 mm 2-1/4"		537
		08-10	REPUESTO FRENO DE DISCO	2027	TRAS	34.0 mm		
XL7		07-09	MANGUERA DE FRENOS	382700	DEL IZQ	18.81"		483
		07-09	MANGUERA DE FRENOS	382701	DEL DER	18.81"		483
TOYOTA								
4 RUNNER		03-09	MANGUERA DE FRENOS	381613	DEL DER	11.25"		451
		03-09	MANGUERA DE FRENOS	381613	DEL IZQ	11.25"		451
		03-09	PISTÓN FRENO DE DISCO	851002	DEL	45.5 mm		530
		03-09	REPUESTO FRENO DE DISCO	21028	DEL	45.5 mm		547
		96-01	CILINDRO DE CLUTCH	360055		20.6 mm 13/16"		
		94-95	CILINDRO MAESTRO	390236		26.9 mm 1-1/16"		305
		96-01	CILINDRO MAESTRO	390367		25.4 mm 1"	C/ABS CHOCOLATE	310
		96-01	CILINDRO MAESTRO	390368		25.4 mm 1"	S/ABS CHOCOLATE	310
CAMRY		03-09	KIT DE PISTÓN Y REPUESTO FD	742414	DEL	45.5 mm		
		05-06	MANGUERA DE FRENOS	381468	TRAS DER	15.75"		446
		05-06	MANGUERA DE FRENOS	381469	TRAS IZQ	15.75"		446
		05-06	MANGUERA DE FRENOS	381646	DEL DER	18.5"		452
		05-06	MANGUERA DE FRENOS	381647	DEL IZQ	18.75"		452
		05-06	MANGUERA DE FRENOS	381649	TRAS IZQ	23.12"		452
		07-11	MANGUERA DE FRENOS	382365	DEL IZQ	19.38"		460
		07-11	MANGUERA DE FRENOS	382592	DEL DER	19.25"		475
		07-11	MANGUERA DE FRENOS	382593	TRAS IZQ	20.19"		475
		07-11	MANGUERA DE FRENOS	382594	TRAS DER	23.38"		475
		07-11	MANGUERA DE FRENOS	382595	DEL IZQ	19.25"		475
		07-11	MANGUERA DE FRENOS	382596	DEL DER	19.5"		475
		07-11	MANGUERA DE FRENOS	382627	TRAS DER	23.44"		478
		05-11	PISTÓN FRENO DE DISCO	85476	TRAS	38.1 mm 1-1/2"		525
		07-11	PISTÓN FRENO DE DISCO	851030	DEL	N/D		532
		05-08	PISTÓN FRENO DE DISCO	853220	DEL	63.5 mm 2-1/2"		534
		05-11	REPUESTO FRENO DE DISCO	2476	TRAS	38.1 mm 1-1/2"		
		07-11	REPUESTO FRENO DE DISCO	21030	DEL	63.5 mm 2-1/2"		548
	05-08	REPUESTO FRENO DE DISCO	23220	DEL	63.5 mm 2-1/2"		552	

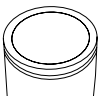



Modelo	Versión	Año	Descripción	Número Lusac	Posición	Diámetro	Notas	Foto Pág.
CAMRY	LE	02-04	CILINDRO DE RUEDA	370111	IZQ	7/8"		376
	LE	00-04	CILINDRO DE RUEDA	370111	IZQ	7/8"	FABRICADO EN JAPÓN	376
	LE	02-04	CILINDRO DE RUEDA	370174	DER	7/8"		379
	LE	00-01	CILINDRO DE RUEDA	370174	DER	7/8"	FABRICADO EN JAPÓN	379
	LE	00-01	CILINDRO MAESTRO	390291		1"	4 CIL S/ABS	
	LE	02-04	CILINDRO MAESTRO	390753		7/8"	C/C ESTABILIDAD	326
	LE	02-04	CILINDRO MAESTRO	390754		7/8"	S/ABS	326
	LE	02-04	CILINDRO MAESTRO	390898		7/8"	3.0 LTS	334
	LE	05-06	CILINDRO MAESTRO	390966		7/8"		336
	LE	09-09	CILINDRO MAESTRO	390967		7/8"	NO FABRICADO EN JAPON	336
	LE	09-09	CILINDRO MAESTRO	390969		7/8"	TRANSEJE AUTOMÁTICO; NO FABRICADO EN JAPÓN; S/C DE ESTABILIDAD	337
	LE	09-11	CILINDRO MAESTRO	390971		7/8"	FABRICADO EN JAPÓN	337
	LE	09-11	CILINDRO MAESTRO	391337		3/4"	HYBRID	356
	LE	02-04	MANGUERA DE FRENOS	381468	TRAS DER	15.75"		446
	LE	02-04	MANGUERA DE FRENOS	381469	TRAS IZQ	15.75"		446
	LE	02-04	MANGUERA DE FRENOS	381646	DEL DER	18.5"		452
	LE	02-04	MANGUERA DE FRENOS	381647	DEL IZQ	18.75"		452
	LE	02-04	MANGUERA DE FRENOS	381649	TRAS IZQ	23.12"		452
	LE	02-04	PISTÓN FRENO DE DISCO	85476	TRAS	38.1 mm 1-1/2"		525
	LE	02-04	PISTÓN FRENO DE DISCO	853220	DEL	63.5 mm 2-1/2"		534
	LE	02-04	REPUESTO FRENO DE DISCO	2476	TRAS	38.1 mm 1-1/2"		
	LE	02-04	REPUESTO FRENO DE DISCO	23220	DEL	63.5 mm 2-1/2"		552
	LE, XLE	05-06	CILINDRO DE RUEDA	370111	IZQ	7/8"		376
	LE, XLE	05-06	CILINDRO DE RUEDA	370174	DER	7/8"		379
	LE, XLE	05-06	CILINDRO MAESTRO	390754		7/8"	S/ABS	326
	LE, XLE	05-06	CILINDRO MAESTRO	390857		7/8"	C/C ESTABILIDAD	332
	LE, XLE	05-06	CILINDRO MAESTRO	390898		7/8"	3.0 LTS	334
	LE, XLE	05-06	CILINDRO MAESTRO	390899		15/16"	2.4 LTS	334
	LE, XLE	07-08	CILINDRO MAESTRO	390971		7/8"	Fabricado en Japón	337
	LE, XLE	07-08	CILINDRO MAESTRO	391337		3/4"		356
	SE	09-09	CILINDRO MAESTRO	390969		7/8"	TRANSEJE AUTOMÁTICO; NO FABRICADO EN JAPÓN; S/C DE ESTABILIDAD	337
	SE	09-11	CILINDRO MAESTRO	390971		7/8"	FABRICADO EN JAPÓN	337
	XLE	09-09	CILINDRO MAESTRO	390969		7/8"	TRANSEJE AUTOMÁTICO; NO FABRICADO EN JAPÓN; S/C DE ESTABILIDAD	337
	XLE	09-11	CILINDRO MAESTRO	390971		7/8"	FABRICADO EN JAPÓN	337
		09-09	CILINDRO MAESTRO	390969		7/8"	TRANSEJE AUTOMÁTICO; NO FABRICADO EN JAPÓN; S/C DE ESTABILIDAD	337
		07-11	CILINDRO MAESTRO	390970		22.2 mm 7/8"	C/C DE ESTABILIDAD CON TRANSEJE AUTOMÁTICO EXCEPTO FABRICADO EN JAPÓN	





Modelo	Versión	Año	Descripción	Número Lusac	Posición	Diámetro	Notas	Foto Pág.
TOYOTA								
CAMRY		09-11	CILINDRO MAESTRO	390971		7/8"	FABRICADO EN JAPÓN	337
		07-11	KIT DE PISTÓN Y REPUESTO FD	742310	TRAS	38.1 mm 1-1/2"		
		02-11	KIT DE PISTÓN Y REPUESTO FD	742396	TRAS	38.1 mm 1-1/2"		
		07-12	KIT DE PISTÓN Y REPUESTO FD	742425	DEL	63.5 mm 2-1/2"		
		05-05	REPUESTO FRENO DE DISCO	2005	DEL	74.6 mm 2-15/16"		538
COROLLA		03-08	MANGUERA DE FRENOS	381455	TRAS IZQ	10.55"		446
		03-08	MANGUERA DE FRENOS	382422	DEL DER	24.38"		465
		03-08	MANGUERA DE FRENOS	382423	DEL IZQ	24.38"		465
		03-11	PISTÓN FRENO DE DISCO	851330	DEL	57.1 mm 2-1/4"		534
		03-11	REPUESTO FRENO DE DISCO	21330	DEL	57.1 mm 2-1/4"		551
	CE, LE	03-08	CILINDRO DE RUEDA	370139	DER	3/4"		378
	CE, LE	03-08	CILINDRO DE RUEDA	370146	IZQ	3/4"		378
	CE, LE	03-08	CILINDRO MAESTRO	390735		20.6 mm 13/16"	AUTOMÁTICO	325
	S	05-08	CILINDRO MAESTRO	390735		20.6 mm 13/16"	AUTOMÁTICO	325
	S	10-10	CILINDRO MAESTRO	391274		7/8"		353
	S	05-08	MANGUERA DE FRENOS	381455	TRAS IZQ	10.55"		446
	S	05-08	MANGUERA DE FRENOS	381673	DEL DER	24.31"		453
	S	05-08	PISTÓN FRENO DE DISCO	851330	DEL	57.1 mm 2-1/4"		534
	S	10-10	PISTÓN FRENO DE DISCO	851330	DEL	57.1 mm 2-1/4"		534
	S	05-08	REPUESTO FRENO DE DISCO	21330	DEL	57.1 mm 2-1/4"		551
	XRS	98-02	CILINDRO DE RUEDA	37635	DER	3/4"	C/ABS	
	XRS	98-02	CILINDRO DE RUEDA	37637	IZQ	11/16"	S/ABS	
	XRS	98-02	CILINDRO DE RUEDA	37646	DER	11/16"	S/ABS	
	XRS	97-01	MANGUERA DE FRENOS	380516	TRAS IZQ DER	12.75"		423
	XRS, CE, LE, S	02-02	MANGUERA DE FRENOS	381455	TRAS	10.55"	CE	446
		09-14	CILINDRO MAESTRO	391274		7/8"		353
FJ CRUISER	PREMIUM	07-14	MANGUERA DE FRENOS	381613	DEL DER	11.25"		451
	PREMIUM	07-14	MANGUERA DE FRENOS	381613	DEL IZQ	11.25"		451
		08-14	MANGUERA DE FRENOS	381613	DEL DER	11.25"		451
		08-14	MANGUERA DE FRENOS	381613	DEL IZQ	11.25"		451
		07-07	MANGUERA DE FRENOS	381614	INT	12.88"		451
HIACE		06-13	PISTÓN FRENO DE DISCO	851075	DEL	66.7 mm 2-5/8"		534
		06-13	REPUESTO FRENO DE DISCO	21075	DEL	66.7 mm 2-5/8"		550
		06-13	CILINDRO DE RUEDA	370032	IZQ	15/16"		374
		06-13	CILINDRO DE RUEDA	370143	IZQ	7/8"		378
		06-13	CILINDRO MAESTRO	39009909		13/16"		361
HIGHLANDER		08-14	CILINDRO MAESTRO	391138		7/8"		344
HILUX		06-12	CILINDRO DE RUEDA	3700926	Tras	22.2 mm 7/8"		
		04-10	PISTÓN FRENO DE DISCO	851076	DEL	42.8 mm 1-11/16"		534
		04-10	REPUESTO FRENO DE DISCO	21076	DEL	42.8 mm 1-11/16"		550
LAND CRUISER		98-07	MANGUERA DE FRENOS	381292	TRAS IZQ	9.95"		440

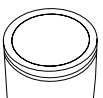

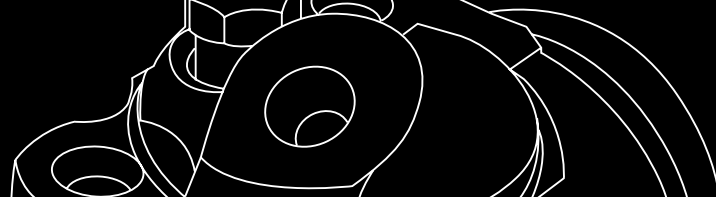

Modelo	Versión	Año	Descripción	Número Lusac	Posición	Diámetro	Notas	Foto Pág.
MATRIX		98-07	MANGUERA DE FRENOS	381295	DEL DER	15.85"		440
		98-07	MANGUERA DE FRENOS	381296	DEL IZQ	15.85"		440
		04-14	MANGUERA DE FRENOS	381612	TRAS IZQ	14"		451
	AWD	11-13	CILINDRO MAESTRO	391173		7/8"	2.4 LTS	346
	AWD	11-13	CILINDRO MAESTRO	391274		7/8"	1.8 LTS	353
	XR	03-08	CILINDRO MAESTRO	390735		20.6 mm 13/16"		325
	XR	09-10	CILINDRO MAESTRO	391173		7/8"		346
	XR	09-10	CILINDRO MAESTRO	391274		7/8"		353
	XR	03-08	MANGUERA DE FRENOS	381455	TRAS IZQ	10.55"		446
	XR	03-08	MANGUERA DE FRENOS	381673	DEL DER	24.31"		453
	XR	09-10	PISTÓN FRENO DE DISCO	851031	DEL	60.3 mm 2-3/8"		532
	XR	03-08	PISTÓN FRENO DE DISCO	851330	DEL	57.1 mm 2-1/4"		534
	XR	09-10	REPUESTO FRENO DE DISCO	21031	DEL	60.3 mm 2-3/8"		548
	XR	03-08	REPUESTO FRENO DE DISCO	21330	DEL	57.1 mm 2-1/4"		551
	XR	09-10	REPUESTO FRENO DE DISCO	21980	TRAS	38.1 mm 1-1/2"		551
	09-10	KIT DE PISTÓN Y REPUESTO FD	742426	DEL	60.3 mm 2-3/8"			
MR2	SPYDER	05-06	MANGUERA DE FRENOS	381610	DEL DER	15.12"		450
PICKUP TOYOTA		93-98	CILINDRO DE CLUTCH	39934		15.8 mm 5/8"	CHOCOLATE	
		95-98	CILINDRO DE CLUTCH	360055		20.6 mm 13/16"		
		94-94	CILINDRO MAESTRO	390236		26.9 mm 1-1/16"	CHOCOLATE	305
PRIUS		04-09	CILINDRO DE RUEDA	370139	DER	3/4"		378
		04-09	CILINDRO DE RUEDA	370146	IZQ	3/4"		378
		01-06	MANGUERA DE FRENOS	381455	TRAS	10.55"		446
		04-09	MANGUERA DE FRENOS	382422	DER	24.38"		465
		04-09	MANGUERA DE FRENOS	382423	IZQ	24.38"		465
RAV 4		04-05	MANGUERA DE FRENOS	380516	TRAS DER	12.75"		423
		04-05	MANGUERA DE FRENOS	380516	TRAS IZQ	12.75"		423
		04-05	MANGUERA DE FRENOS	380901	DEL DER	17.98"		428
		04-05	MANGUERA DE FRENOS	380902	DEL IZQ	17.98"		428
		06-13	MANGUERA DE FRENOS	382597	DEL IZQ	29.06"		475
		06-13	MANGUERA DE FRENOS	382598	DEL DER	28.06"		476
		06-13	MANGUERA DE FRENOS	382643	TRAS DER	13.5"		479
		06-13	MANGUERA DE FRENOS	382643	TRAS IZQ	13.5"		479
		06-13	PISTÓN FRENO DE DISCO	853220	DEL	63.5 mm 2-1/2"		534
		04-13	PISTÓN FRENO DE DISCO	853271	TRAS	32.1 mm 1-17/64"		534
		04-05	PISTÓN FRENO DE DISCO	853940	DEL	60.3 mm 2-3/8"		535
		06-13	REPUESTO FRENO DE DISCO	2476	TRAS	38.1 mm 1-1/2"		
		06-13	REPUESTO FRENO DE DISCO	21019	DEL	65.9 mm 2-19/32"		547
		06-13	REPUESTO FRENO DE DISCO	23220	DEL	63.5 mm 2-1/2"		552
		04-05	REPUESTO FRENO DE DISCO	23270	DEL	60.3 mm 2-3/8"		552
		04-13	REPUESTO FRENO DE DISCO	23271	TRAS	32.1 mm 1-17/64"		552
		04-05	CILINDRO MAESTRO	390825		7/8"	C/C DE ESTABILIDAD ESTÁNDAR	330
	04-05	CILINDRO MAESTRO	390832		7/8"	AUTO C/C DE ESTABILIDAD	331	





Modelo	Versión	Año	Descripción	Número Lusac	Posición	Diámetro	Notas	Foto Pág.
TOYOTA								
RAV 4		04-05	CILINDRO MAESTRO	390833		13/16"	AUTO S/C DE ESTABILIDAD	331
		08-10	KIT DE PISTÓN Y REPUESTO FD	742310	TRAS	38.1 mm 1-1/2"		
		04-10	KIT DE PISTÓN Y REPUESTO FD	742401	TRAS	32.1 mm 1-17/64"		
SEQUOIA		08-14	CILINDRO MAESTRO	391085		15/16"		342
		01-07	MANGUERA DE FRENOS	38986	DEL IZQ DER	11.5"		403
SIENNA		04-06	MANGUERA DE FRENOS	381607	DEL CTR	9.35"		450
		04-10	PISTÓN FRENO DE DISCO	853220	DEL	63.5 mm 2-1/2"		534
		04-10	REPUESTO FRENO DE DISCO	21051	DEL	63.5 mm 2-1/2"		549
		04-10	REPUESTO FRENO DE DISCO	23220	DEL	63.5 mm 2-1/2"		552
		04-10	CILINDRO DE RUEDA	370143	TRAS IZQ DER	7/8"		378
		04-10	CILINDRO MAESTRO	390870		3/4" & 15/16"	C/C DE TRACCIÓN	333
		11-14	CILINDRO MAESTRO	391138		7/8"		344
		98-03	MANGUERA DE FRENOS	380516	TRAS IZQ DER	12.75"		423
	SOLARA		05-06	MANGUERA DE FRENOS	381646	DEL DER	18.5"	
		05-06	MANGUERA DE FRENOS	381647	DEL IZQ	18.75"		452
		05-06	MANGUERA DE FRENOS	381649	TRAS IZQ	23.12"		452
		05-06	PISTÓN FRENO DE DISCO	85476	TRAS	38.1 mm 1-1/2"		525
		05-06	PISTÓN FRENO DE DISCO	853220	DEL	63.5 mm 2-1/2"		534
		05-06	REPUESTO FRENO DE DISCO	2476	TRAS	38.1 mm 1-1/2"		
		05-06	REPUESTO FRENO DE DISCO	21051	DEL	63.5 mm 2-1/2"		549
		05-06	REPUESTO FRENO DE DISCO	23220	DEL	63.5 mm 2-1/2"		552
		04-04	CILINDRO MAESTRO	390754		7/8"	TRANSEJE MANUAL	326
		07-08	CILINDRO MAESTRO	390754		7/8"	TRANSEJE MANUAL	326
		04-08	CILINDRO MAESTRO	390898		7/8"	TRANSEJE AUTOMÁTICO; S/C TRACCIÓN	334
		04-08	CILINDRO MAESTRO	390899		15/16"	TRANSEJE AUTOMÁTICO; C/C TRACCIÓN	334
		05-07	KIT DE PISTÓN Y REPUESTO FD	742396	TRAS	38.1 mm 1-1/2"		
		04-04	MANGUERA DE FRENOS	381646	DER	18.5"		452
		04-08	MANGUERA DE FRENOS	381647	IZQ	18.75"		452
		07-08	MANGUERA DE FRENOS	381646	DER	18.5"		452
		04-04	MANGUERA DE FRENOS	381649	IZQ	23.12"		452
	07-08	MANGUERA DE FRENOS	382627	DER	23.44"		478	
TACOMA		06-11	MANGUERA DE FRENOS	38986	DEL DER	11.5"		403
		06-11	MANGUERA DE FRENOS	38986	DEL IZQ	11.5"		403
		06-14	PISTÓN FRENO DE DISCO	851002	DEL	45.5 mm		530
		06-14	REPUESTO FRENO DE DISCO	21022	TRAS	54.0 mm 2-1/8"		547
	LIMITED	98-04	CILINDRO DE RUEDA	370032	IZQ	15/16"	4X2	374
	LIMITED	98-04	CILINDRO DE RUEDA	370032	DER	15/16"	4X2	374
TACOMA	PRE RUNNER SR5	98-04	CILINDRO DE RUEDA	37841	DER	7/8"	4X2	

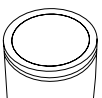



Modelo	Versión	Año	Descripción	Número Lusac	Posición	Diámetro	Notas	Foto Pág.	
TACOMA	PRE RUNNER	05-05	CILINDRO MAESTRO	390964		13/16"	TRANSMISIÓN AUTOMÁTICA	336	
	PRE RUNNER	05-05	MANGUERA DE FRENOS	38986	DEL IZQ DER	11.5"		403	
	PRE RUNNER TRD SPORT	05-05	CILINDRO MAESTRO	390964		13/16"	TRANSMISIÓN AUTOMÁTICA	336	
	SR5	98-04	CILINDRO DE RUEDA	370032	IZQ	15/16"	4X2	374	
	SR5	98-04	CILINDRO DE RUEDA	370032	DER	15/16"	4X2	374	
	S-RUNNER	01-04	CILINDRO DE RUEDA	370032	IZQ	15/16"	4X2	374	
	S-RUNNER	01-04	CILINDRO DE RUEDA	370032	DER	15/16"	4X2	374	
	TRD	05-05	MANGUERA DE FRENOS	38986	DEL IZQ DER	11.5"		403	
	TRD	05-05	MANGUERA DE FRENOS	38986	DEL IZQ DER	11.5"		403	
		95-02	CILINDRO DE CLUTCH	39934			15.8 mm 5/8"		
		95-04	CILINDRO DE CLUTCH	360055			20.6 mm 13/16"		
		95-04	CILINDRO DE RUEDA	37841	TRAS IZQ DER	7/8"	4X4		
		01-04	CILINDRO DE RUEDA	370032	TRAS IZQ DER	15/16"	4X2		374
		06-14	CILINDRO DE RUEDA	370133	DER	11/16"			378
		05-14	CILINDRO DE RUEDA	370143	DER	7/8"			378
		06-14	CILINDRO DE RUEDA	370143	IZQ	7/8"			378
		05-14	CILINDRO DE RUEDA	370183	IZQ	15/16"			380
		95-00	CILINDRO MAESTRO	390285			1"	S/ABS	307
		95-01	CILINDRO MAESTRO	390289			25.4 mm 1"	4X4 C/ABS CHOCOLATE	307
		01-04	CILINDRO MAESTRO	390824			20.6 mm 13/16"	FABRICADO EN USA	330
		05-08	CILINDRO MAESTRO	390964			13/16"	4X2	336
		06-08	CILINDRO MAESTRO	390965			13/16"	4X4	336
		06-14	KIT DE PISTÓN Y REPUESTO FD	742411	DEL		45.5 mm	CALIPER DE 4 PISTONES	
		05-05	MANGUERA DE FRENOS	38986	DEL IZQ DER	11.5"			403
		05-05	MANGUERA DE FRENOS	38986	DEL IZQ DER	11.5"			403
		06-14	REPUESTO FRENO DE DISCO	21002	DEL		45.5 mm	CALIPER DE 4 PISTONES	545
TUNDRA		00-04	CILINDRO DE CLUTCH	360055			20.6 mm 13/16"	CHOCOLATE	
		00-06	CILINDRO DE RUEDA	37690	TRAS IZQ DER	1"			366
		07-13	CILINDRO MAESTRO	391085			15/16"		342
		00-06	MANGUERA DE FRENOS	38986	DEL IZQ DER	11.5"			403
YARIS	HATCH BACK	04-07	CILINDRO DE RUEDA	370139	DER	3/4"		378	
	HATCH BACK	04-07	CILINDRO DE RUEDA	370146	IZQ	3/4"		378	
	HATCH BACK	06-07	CILINDRO MAESTRO	391005			13/16"	ESTÁNDAR	339
	HATCH BACK	06-07	CILINDRO MAESTRO	391006			13/16"	AUTOMÁTICO	339
	HATCH BACK	04-07	PISTÓN FRENO DE DISCO	853260	DEL		50.8 mm 2"		534
	HATCH BACK	04-07	REPUESTO FRENO DE DISCO	23260	DEL		50.8 mm 2"		552
	SEDAN	06-14	CILINDRO DE RUEDA	370139	DER	3/4"			378
	SEDAN	06-14	CILINDRO DE RUEDA	370146	IZQ	3/4"			378
	SEDAN	06-11	CILINDRO MAESTRO	391005			13/16"	ESTÁNDAR	339
	SEDAN	06-11	CILINDRO MAESTRO	391006			13/16"	AUTOMÁTICO	339
	SEDAN	10-14	MANGUERA DE FRENOS	38986	TRAS DER	11.5"			403
	SEDAN	06-14	PISTÓN FRENO DE DISCO	851014	DEL		54.0 mm 2-1/8"		531





Modelo	Versión	Año	Descripción	Número Lusac	Posición	Diámetro	Notas	Foto Pág.
TOYOTA								
YARIS	SEDAN	06-14	REPUESTO FRENO DE DISCO	21014	DEL	54.0 mm 2-1/8"		546
		01-05	CILINDRO DE RUEDA	3700927	TRAS	N/D	HATCHBACK	
		12-14	CILINDRO MAESTRO	391376		20.6 mm 13/16"	SEDAN	
VAM								
AMERICAN		77-83	KIT DE PISTÓN Y REPUESTO FD	742334	DEL	65.9 mm 2-19/32"		
CLASSIC		76-76	KIT DE PISTÓN Y REPUESTO FD	742334	DEL	65.9 mm 2-19/32"	S/BOOSTER	
JEEPCJ-5	JEEP	84-86	CILINDRO DE RUEDA	17507	IZQ	7/8"		364
	JEEP	84-86	CILINDRO DE RUEDA	17508	DER	7/8"		364
	JEEP	84-86	MANGUERA DE FRENOS	4016	DEL DER	16 3/16"		
	JEEP	84-86	MANGUERA DE FRENOS	4016	DEL IZQ	16 3/16"		
	JEEP	84-86	MANGUERA DE FRENOS	38129	TRAS IZQ	18.75"		
	JEEP	84-86	REPUESTO FRENO DE DISCO	1473	DEL	66.0 mm		537
RALLY		76-83	KIT DE PISTÓN Y REPUESTO FD	742334	DEL	65.9 mm 2-19/32"		
WAGONEER		85-86	MANGUERA DE FRENOS	38158	DEL DER	15.38"		
		85-86	MANGUERA DE FRENOS	38158	DEL IZQ	15.38"		
		85-86	PISTÓN FRENO DE DISCO	76008	DEL	74.6 mm 2-15/16"		518
		85-86	REPUESTO FRENO DE DISCO	59176	DEL	74.6 mm 2-15/16"		552
		85-86	CILINDRO DE RUEDA	17507	IZQ	7/8"		364
		85-86	CILINDRO DE RUEDA	17508	DER	7/8"		364
		85-86	CILINDRO MAESTRO	104516		28.5 & 40.0 mm		297
		85-86	REP. CIL. MAESTRO Y DE CLUTCH	104459		28.5 mm 1-1/8"		560
VOLKSWAGEN								
ATLANTIC		81-87	MANGUERA DE FRENOS	6031	DEL DER	13 1/4"		387
		81-87	MANGUERA DE FRENOS	6031	DEL IZQ	13 1/4"		387
		81-87	MANGUERA DE FRENOS	38164	DEL DER	11.5"		
		81-87	MANGUERA DE FRENOS	38164	DEL IZQ	11.5"		
		81-87	MANGUERA DE FRENOS	7007M	TRAS IZQ	7 1/4"		516
		81-87	PISTÓN FRENO DE DISCO	96388	DEL	44.0 mm		
		81-87	PISTÓN FRENO DE DISCO	98726	DEL	44.0 mm		
		81-87	REPUESTO FRENO DE DISCO	128	DEL	44.0 mm	CALIPER GIRLING	
		81-87	REPUESTO FRENO DE DISCO	129	DEL	44.0 mm	CALIPER ATE	
		81-87	CILINDRO DE RUEDA	96399	DER	17.4 mm 11/16"		371
		81-87	CILINDRO DE RUEDA	96399	IZQ	17.4 mm 11/16"		371
		81-87	CILINDRO MAESTRO	96409		20.6 mm 13/16"	CIL FAG	
		81-87	REP. CIL. MAESTRO Y DE CLUTCH	196		20.6 mm 13/16"		
	81-87	REP. CIL. MAESTRO Y DE CLUTCH	197		20.6 mm 13/16"			
BEETLE	CABRIOLET, GLX SPORT	06-10	CILINDRO MAESTRO	390925		15/16"	2.5 LTS	335
	CABRIOLET, GLX SPORT	06-10	CILINDRO MAESTRO	391092		15/16"		342
	CABRIOLET, GLX SPORT	11-14	CILINDRO MAESTRO	391232		7/8"	2.5 LTS	351
	GL, GLS, GLX, CABRIOLET TURBO	98-05	CILINDRO MAESTRO	390500		15/16"	2.0 LTS	316

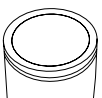



Modelo	Versión	Año	Descripción	Número Lusac	Posición	Diámetro	Notas	Foto Pág.
BORA	GL, GLS, GLX, CABRIOLET TURBO	98-10	CILINDRO MAESTRO	390925		15/16"	CALIPER LUCAS	335
	GL, GLS, GLX, CABRIOLET TURBO	02-10	CILINDRO MAESTRO	391092		15/16"	2.0 LTS	342
	GL, GLS, GLX, CABRIOLET TURBO	11-14	CILINDRO MAESTRO	391232		7/8"	2.0 LTS	351
	GL, GLS, GLX, CABRIOLET TURBO	98-05	CILINDRO MAESTRO	IJ1614019		23.8 mm 15/16"	CALIPER LUCAS	363
	GLS GLX TURBO	00-05	CILINDRO MAESTRO	390500		15/16"	1.8 LTS	316
	GLS GLX TURBO	00-05	CILINDRO MAESTRO	390925		15/16"	FTE C/C DE ESTABILIDAD	335
	GLS GLX TURBO	02-05	CILINDRO MAESTRO	391092		15/16"	C/C DE ESTABILIDAD	342
	GLS GLX TURBO	00-05	CILINDRO MAESTRO	IJ1614019		23.8 mm 15/16"	RFD CALIPER LUCAS	363
	GLS GLX TURBO	00-05	MANGUERA DE FRENOS	381103	TRAS DER	6.58"		433
	GLS GLX TURBO	00-05	MANGUERA DE FRENOS	381103	TRAS IZQ	6.58"		433
	GLS GLX TURBO	98-10	PISTÓN FRENO DE DISCO	2902	DEL	54.0 mm 2-1/8"		517
	GLS GLX TURBO	98-10	REPUESTO FRENO DE DISCO	1449	DEL	54.0 mm 2-1/8"		537
	GLS GLX TURBO	98-10	REPUESTO FRENO DE DISCO	2103	TRAS	38.1 mm 1-1/2"		539
		98-14	REPUESTO FRENO DE DISCO	2810	DEL	54.0 mm 2-1/8"		543
		98-10	KIT DE PISTÓN Y REPUESTO FD	742393	DEL	54.0 mm 2-1/8"		
		06-10	MANGUERA DE FRENOS	382497	TRAS IZQ	10.08"		467
		06-10	PISTÓN FRENO DE DISCO	85810	DEL	54.0 mm 2-1/8"		526
		06-10	REPUESTO FRENO DE DISCO	2183	TRAS	40.0 mm		
		06-10	REPUESTO FRENO DE DISCO	2810	DEL	54.0 mm 2-1/8"		543
	ACTIVE, STYLE PRESTIGE EXCLUSIVE SPORT SPORTWAGEN	06-10	CILINDRO MAESTRO	391232		7/8"	2.5 LTS	351
	ACTIVE, STYLE PRESTIGE EXCLUSIVE SPORT SPORTWAGEN	06-10	CILINDRO MAESTRO	391390		N/D	CIL TEVES	358
	TDI, GLI FHARENHEIT TURBO	06-10	CILINDRO MAESTRO	391232		7/8"	FTE 1.9 LTS	351
	TDI, GLI FHARENHEIT TURBO	06-10	CILINDRO MAESTRO	391390		N/D	CIL TEVES	358
GLI, TURBO	06-10	MANGUERA DE FRENOS	382497	TRAS IZQ	10.08"		467	





Modelo	Versión	Año	Descripción	Número Lusac	Posición	Diámetro	Notas	Foto Pág.
VOLKSWAGEN								
BORA	GLI, TURBO	06-10	PISTÓN FRENO DE DISCO	85810	DEL	54.0 mm 2-1/8"		526
	GLI, TURBO	06-10	REPUESTO FRENO DE DISCO	2183	TRAS	40.0 mm		
	GLI, TURBO	06-10	REPUESTO FRENO DE DISCO	2810	DEL	54.0 mm 2-1/8"		543
	GLI, TURBO	06-10	CILINDRO MAESTRO	391232		7/8"	2.0 LTS	351
	GLI, TURBO	06-10	CILINDRO MAESTRO	391390		N/D	CIL TEVES	358
CARIBE		78-87	MANGUERA DE FRENOS	6031	DEL DER	13 1/4"		387
		78-87	MANGUERA DE FRENOS	6031	DEL IZQ	13 1/4"		387
		78-87	MANGUERA DE FRENOS	6032M	DEL DER	N/D		
		78-87	MANGUERA DE FRENOS	6032M	DEL IZQ	N/D		
		78-87	MANGUERA DE FRENOS	7007M	TRAS IZQ	7 1/4"		516
		78-87	PISTÓN FRENO DE DISCO	96388	DEL	44.0 mm		
		78-87	PISTÓN FRENO DE DISCO	98726	DEL	44.0 mm		
		78-87	REPUESTO FRENO DE DISCO	128	DEL	44.0 mm	CALIPER GIRLING	
		78-87	REPUESTO FRENO DE DISCO	129	DEL	44.0 mm	CALIPER ATE	
	GT	83-86	CILINDRO DE RUEDA	96399	DER	17.4 mm 11/16"		371
	GT	83-86	CILINDRO DE RUEDA	96399	IZQ	17.4 mm 11/16"		371
	GT	83-86	CILINDRO MAESTRO	96409		20.6 mm 13/16"	CIL FAG	
	GT	83-86	MANGUERA DE FRENOS	38164	DEL DER	11.5"		
	GT	83-86	MANGUERA DE FRENOS	38164	DEL IZQ	11.5"		
	GT	83-86	MANGUERA DE FRENOS	7007M	TRAS IZQ	7 1/4"		516
	GT	83-86	PISTÓN FRENO DE DISCO	96388	DEL	44.0 mm		
	GT	83-86	PISTÓN FRENO DE DISCO	98726	DEL	44.0 mm		
	GT	83-86	REP. CIL. MAESTRO Y DE CLUTCH	196		20.6 mm 13/16"		
	GT	83-86	REP. CIL. MAESTRO Y DE CLUTCH	197		20.6 mm 13/16"		
	GT	83-86	REPUESTO FRENO DE DISCO	128	DEL	44.0 mm		
	GT	83-86	REPUESTO FRENO DE DISCO	129	DEL	44.0 mm		
		78-87	CILINDRO DE RUEDA	96399	DER	17.4 mm 11/16"		371
		78-87	CILINDRO DE RUEDA	96399	IZQ	17.4 mm 11/16"		371
		78-87	CILINDRO MAESTRO	96409		20.6 mm 13/16"	CIL FAG	
		78-87	REP. CIL. MAESTRO Y DE CLUTCH	196		20.6 mm 13/16"		
	78-87	REP. CIL. MAESTRO Y DE CLUTCH	197		20.6 mm 13/16"			
COMBI		73-01	CILINDRO DE RUEDA	96387	DER	23.8 mm 15/16"		371
		73-01	CILINDRO DE RUEDA	96387	IZQ	23.8 mm 15/16"		371
		73-88	CILINDRO MAESTRO	390951RL		20.6 mm 13/16"		
		88-01	MANGUERA DE FRENOS	6024	TRAS IZQ	11"		387
		73-88	MANGUERA DE FRENOS	7006	DEL DER	13 1/4"		
		73-88	MANGUERA DE FRENOS	7006	DEL IZQ	13 1/4"		
		88-01	MANGUERA DE FRENOS	7010	DEL DER	13 1/4"		387
		88-01	MANGUERA DE FRENOS	7010	DEL IZQ	13 1/4"		387
		73-88	MANGUERA DE FRENOS	7005M	TRAS IZQ	10 3/4"		516
		73-01	PISTÓN FRENO DE DISCO	96373	DEL	54.0 mm 2-1/8"		527
		73-88	REP. CIL. MAESTRO Y DE CLUTCH	151		20.5 mm		

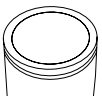



Modelo	Versión	Año	Descripción	Número Lusac	Posición	Diámetro	Notas	Foto Pág.
COMBI		88-01	REP. CIL. MAESTRO Y DE CLUTCH	152		23.8 mm 15/16"		556
		73-01	REPUESTO FRENO DE DISCO	126	DEL	54.0 mm 2-1/8"		536
CORRADO		94-94	CILINDRO DE CLUTCH	350071		19.0 mm 3/4"	CHOCOLATE	
CORSAR		84-88	MANGUERA DE FRENOS	6031	DEL DER	13 1/4"		387
		84-88	MANGUERA DE FRENOS	6031	DEL IZQ	13 1/4"		387
		84-88	MANGUERA DE FRENOS	7007M	TRAS IZQ	7 1/4"		516
		84-84	PISTÓN FRENO DE DISCO	96388	DEL	44.0 mm		
		84-84	PISTÓN FRENO DE DISCO	98726	DEL	44.0 mm		
		84-88	PISTÓN FRENO DE DISCO	98728	DEL	48.0 mm 1-57/64"		527
		84-88	REPUESTO FRENO DE DISCO	124	DEL	48.0 mm 1-57/64"		536
		84-86	REPUESTO FRENO DE DISCO	128	DEL	44.0 mm	CALIPER GIRLING	
		84-84	REPUESTO FRENO DE DISCO	129	DEL	44.0 mm	CALIPER ATE	
	VARIANT	86-88	CILINDRO DE RUEDA	96399	DER	17.4 mm 11/16"		371
	VARIANT	86-88	CILINDRO DE RUEDA	96399	IZQ	17.4 mm 11/16"		371
	VARIANT	86-88	MANGUERA DE FRENOS	6031	DEL DER	13 1/4"		387
	VARIANT	86-88	MANGUERA DE FRENOS	6031	DEL IZQ	13 1/4"		387
	VARIANT	86-88	MANGUERA DE FRENOS	7007M	TRAS IZQ	7 1/4"		516
	VARIANT	86-88	PISTÓN FRENO DE DISCO	98728	DEL	48.0 mm 1-57/64"		527
	VARIANT	86-88	REP. CIL. MAESTRO Y DE CLUTCH	191		48.0mm		
	VARIANT	86-88	REPUESTO FRENO DE DISCO	124	DEL	48.0 mm 1-57/64"		536
		84-88	CILINDRO DE RUEDA	96399	DER	17.4 mm 11/16"		371
		84-88	CILINDRO DE RUEDA	96399	IZQ	17.4 mm 11/16"		371
		85-88	KIT DE PISTÓN Y REPUESTO FD	742386	DEL	48.0 mm 1-57/64"		
	84-86	REP. CIL. MAESTRO Y DE CLUTCH	191		48.0mm			
CRAFTER		08-12	KIT DE PISTÓN Y REPUESTO FD	742434	DEL	52.0 mm 2-3/64"	CON CALIPER DE DOBLE PISTON CUBREPOLVO SUAVE	
		08-12	KIT DE PISTÓN Y REPUESTO FD	742435	DEL	48.0 mm 1-57/64"	CON CALIPER DE DOBLE PISTON CUBREPOLVO SUAVE	
		08-12	KIT DE PISTÓN Y REPUESTO FD	742436	DEL	48.0 mm 1-57/64"	CON CALIPER DE DOBLE PISTON CUBREPOLVO DURO	
		08-12	PISTÓN FRENO DE DISCO	851048	DEL	52.0mm 2-3/64"		532
		08-12	REPUESTO FRENO DE DISCO	21048	DEL	52.0mm 2-3/64"		549
		08-12	REPUESTO FRENO DE DISCO	21049	DEL	48.0 mm 1-57/64"		549
		08-12	REPUESTO FRENO DE DISCO	21053	TRAS	48.0 mm 1-57/64"		549
CROSS FOX		07-09	PISTÓN FRENO DE DISCO	2902	DEL	54.0 mm 2-1/8"		517
		11-11	PISTÓN FRENO DE DISCO	2902	DEL	54.0 mm 2-1/8"		517
		07-09	REPUESTO FRENO DE DISCO	1449	DEL	54.0 mm 2-1/8"		537
		11-11	REPUESTO FRENO DE DISCO	1449	DEL	54.0 mm 2-1/8"		537

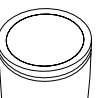



Modelo	Versión	Año	Descripción	Número Lusac	Posición	Diámetro	Notas	Foto Pág.
VOLKSWAGEN								
CROSS FOX		11-14	CILINDRO MAESTRO	39009912		3/4"	C/ABS	361
		07-11	KIT DE PISTÓN Y REPUESTO FD	742393	DEL	54.0 mm 2-1/8"		
DERBY		95-09	MANGUERA DE FRENOS	381103	TRAS IZQ	6.58"		433
		95-97	MANGUERA DE FRENOS	7007M	TRAS IZQ	7 1/4"		516
		01-09	PISTÓN FRENO DE DISCO	85860	DEL	54.0 mm 2-1/8"		527
		95-00	PISTÓN FRENO DE DISCO	98728	DEL	48.0 mm 1-57/64"		527
		95-00	REPUESTO FRENO DE DISCO	124	DEL	48.0 mm 1-57/64"		536
		01-09	REPUESTO FRENO DE DISCO	1449	DEL	54.0 mm 2-1/8"		537
		95-09	CILINDRO DE RUEDA	37986	DER	3/4"		369
		95-09	CILINDRO DE RUEDA	37986	IZQ	3/4"		369
		95-97	CILINDRO DE RUEDA	96399	DER	17.4 mm 11/16"		371
		95-97	CILINDRO DE RUEDA	96399	IZQ	17.4 mm 11/16"		371
		03-09	CILINDRO DE RUEDA	370113	TRAS DER	19.0 mm 3/4"		377
		03-09	CILINDRO DE RUEDA	370113	TRAS IZQ	19.0 mm 3/4"		377
		95-00	KIT DE PISTÓN Y REPUESTO FD	742386	DEL	48.0 mm 1-57/64"		
		01-09	KIT DE PISTÓN Y REPUESTO FD	742389	DEL	54.0 mm 2-1/8"		
EOS		07-13	CILINDRO MAESTRO	391231		7/8"		351
		10-10	CILINDRO MAESTRO	391390		N/D		358
EUROVAN	5L, 2.5 LTS	01-04	MANGUERA DE FRENOS	380455	DEL DER	14.25"		420
	5L, 2.5 LTS	01-04	MANGUERA DE FRENOS	380455	DEL IZQ	14.25"		420
	5L, 2.5 LTS	01-04	MANGUERA DE FRENOS	7007M	TRAS DER	7 1/4"		516
	5L, 2.5 LTS	01-04	MANGUERA DE FRENOS	7007M	TRAS IZQ	7 1/4"		516
	5L, 2.5 LTS	01-04	PISTÓN FRENO DE DISCO	85860	DEL	54.0 mm 2-1/8"		527
	5L, 2.5 LTS	01-04	REPUESTO FRENO DE DISCO	1449	DEL	54.0 mm 2-1/8"		537
	5L, 2.5 LTS	01-04	REPUESTO FRENO DE DISCO	2103	TRAS	38.1 mm 1-1/2"		539
	DIESEL	06-09	PISTÓN FRENO DE DISCO	851047	DEL	60.0 mm		532
	DIESEL	06-09	REPUESTO FRENO DE DISCO	2183	TRAS	40.0 mm		
	DIESEL	06-09	REPUESTO FRENO DE DISCO	21018	DEL	60.0 mm		547
	VR6, 2.8 LTS	00-04	MANGUERA DE FRENOS	380455	DEL DER	14.25"		420
	VR6, 2.8 LTS	00-04	MANGUERA DE FRENOS	380455	DEL IZQ	14.25"		420
	VR6, 2.8 LTS	00-04	MANGUERA DE FRENOS	7007M	TRAS DER	7 1/4"		516
	VR6, 2.8 LTS	00-04	MANGUERA DE FRENOS	7007M	TRAS IZQ	7 1/4"		516
	VR6, 2.8 LTS	00-04	PISTÓN FRENO DE DISCO	85860	DEL	54.0 mm 2-1/8"		527
	VR6, 2.8 LTS	00-04	REPUESTO FRENO DE DISCO	1449	DEL	54.0 mm 2-1/8"		537
	VR6, 2.8 LTS	00-04	REPUESTO FRENO DE DISCO	2103	TRAS	38.1 mm 1-1/2"		539
		00-03	CILINDRO MAESTRO	391130		25.4 mm 1"	C/ABS	344
		00-02	KIT DE PISTÓN Y REPUESTO FD	742389	DEL	54.0 mm 2-1/8"	2.8 6 VR	
		06-10	KIT DE PISTÓN Y REPUESTO FD	742413	DEL	60.0 mm	DIESEL	
GOL		09-14	PISTÓN FRENO DE DISCO	851005	DEL	48.0 mm 1-57/64"		530

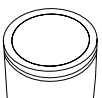

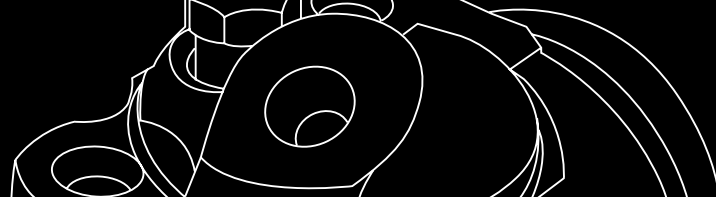

Modelo	Versión	Año	Descripción	Número Lusac	Posición	Diámetro	Notas	Foto Pág.	
GOL		09-14	REPUESTO FRENO DE DISCO	2901	DEL	48.0 mm 1-57/64"		545	
		09-14	CILINDRO DE RUEDA	37576	DER	5/8"		365	
		09-14	CILINDRO DE RUEDA	37576	IZQ	5/8"		365	
		09-14	CILINDRO MAESTRO	39009911		13/16"	S/ABS 1.6 LTS	361	
		09-14	CILINDRO MAESTRO	39009912		3/4"	C/ABS 1.6 LTS	361	
GOLF		87-92	MANGUERA DE FRENOS	6031	DEL DER	13 1/4"		387	
		87-92	MANGUERA DE FRENOS	6031	DEL IZQ	13 1/4"		387	
		93-94	MANGUERA DE FRENOS	380457	DEL DER	19"		420	
		99-99	MANGUERA DE FRENOS	380457	DEL DER	19"		420	
		93-94	MANGUERA DE FRENOS	380457	DEL IZQ	19"		420	
		99-99	MANGUERA DE FRENOS	380457	DEL IZQ	19"		420	
		87-99	MANGUERA DE FRENOS	7007M	TRAS IZQ	7 1/4"		516	
		87-99	PISTÓN FRENO DE DISCO	98728	DEL	48.0 mm 1-57/64"		527	
		87-99	REPUESTO FRENO DE DISCO	124	DEL	48.0 mm 1-57/64"		536	
		A2 C, A2 CL, A2 GL	87-92	CILINDRO DE RUEDA	96399	DER	17.4 mm 11/16"		371
		A2 C, A2 CL, A2 GL	87-92	CILINDRO DE RUEDA	96399	IZQ	17.4 mm 11/16"		371
		A2 C, A2 CL, A2 GL	87-92	CILINDRO MAESTRO	110983		20.6 mm 13/16"	1.8 LTS	298
		A2 C, A2 CL, A2 GL	87-92	CILINDRO MAESTRO	390921RL		22.2 mm 7/8"		362
		A2 C, A2 CL, A2 GL	87-92	REP. CIL. MAESTRO Y DE CLUTCH	194		20.6 mm 13/16"		556
		A2 GTI	89-90	CILINDRO MAESTRO	110983		20.6 mm 13/16"	S/ABS 2.0 LTS	298
		A2 GTI	91-92	CILINDRO MAESTRO	390060		13/16"		300
		A2 GTI	89-90	CILINDRO MAESTRO	390921RL		22.2 mm 7/8"		362
		A2 GTI	89-92	MANGUERA DE FRENOS	6031	DEL DER	13 1/4"		387
		A2 GTI	89-92	MANGUERA DE FRENOS	6031	DEL IZQ	13 1/4"		387
		A2 GTI	89-92	MANGUERA DE FRENOS	38168	TRAS DER	7.38"		389
		A2 GTI	89-92	MANGUERA DE FRENOS	38168	TRAS IZQ	7.38"		389
		A2 GTI	89-92	PISTÓN FRENO DE DISCO	98728	DEL	48.0 mm 1-57/64"		527
		A2 GTI	89-90	REP. CIL. MAESTRO Y DE CLUTCH	194		20.6 mm 13/16"		556
		A2 GTI	89-92	REPUESTO FRENO DE DISCO	124	DEL	48.0 mm 1-57/64"		536
		A2 GTI	89-92	REPUESTO FRENO DE DISCO	1785	TRAS	36.0 mm		
		A3	95-98	MANGUERA DE FRENOS	380457	DEL DER	19"		420
		A3	95-98	MANGUERA DE FRENOS	380457	DEL IZQ	19"		420
		A3 CABRIO	96-99	CILINDRO DE RUEDA	37986	DER	3/4"		369
		A3 CABRIO	96-99	CILINDRO DE RUEDA	37986	IZQ	3/4"		369
		A3 CABRIO	96-96	CILINDRO MAESTRO	390060		13/16"	S/ABS 2.0 LTS	300
		A3 CABRIO	97-99	CILINDRO MAESTRO	390931		2"	S/ABS 2.0 LTS	336
		A3 CABRIO	96-99	MANGUERA DE FRENOS	380457	DEL DER	19"		420
	A3 CABRIO	96-99	MANGUERA DE FRENOS	380457	DEL IZQ	19"		420	
	A3 CABRIO	96-99	MANGUERA DE FRENOS	381103	TRAS IZQ	6.58"		433	
	A3 CABRIO	96-99	PISTÓN FRENO DE DISCO	98728	DEL	48.0 mm 1-57/64"		527	
	A3 CABRIO	96-99	REPUESTO FRENO DE DISCO	124	DEL	48.0 mm 1-57/64"		536	
	A3 CL, A3 GL	93-99	CILINDRO DE RUEDA	37986	DER	3/4"		369	
	A3 CL, A3 GL	93-99	CILINDRO DE RUEDA	37986	IZQ	3/4"		369	





Modelo	Versión	Año	Descripción	Número Lusac	Posición	Diámetro	Notas	Foto Pág.
VOLKSWAGEN								
GOLF	A3 CL, A3 GL	95-96	CILINDRO MAESTRO	390060		13/16"	1.8 LTS	300
	A3 CL, A3 GL	93-94	CILINDRO MAESTRO	390271		7/8"	1.8 LTS	307
	A3 CL, A3 GL	93-94	CILINDRO MAESTRO	390931		2"		336
	A3 CL, A3 GL	97-99	CILINDRO MAESTRO	390931		2"	1.8 LTS	336
	A3 CL, A3 GL	93-94	CILINDRO MAESTRO	390921RL		22.2 mm 7/8"		362
	A3 CL, A3 GL	93-94	REP. CIL. MAESTRO Y DE CLUTCH	90271		22.2 mm 7/8"		558
	A3 GLS	93-99	CILINDRO DE RUEDA	37986	DER	3/4"		369
	A3 GLS	93-99	CILINDRO DE RUEDA	37986	IZQ	3/4"		369
	A3 GLS	93-96	CILINDRO MAESTRO	390060		13/16"	2.0 LTS	300
	A3 GLS	93-94	CILINDRO MAESTRO	390271		7/8"	2.0 LTS	307
	A3 GLS	93-94	CILINDRO MAESTRO	390931		2"	1.8 LTS	336
	A3 GLS	97-99	CILINDRO MAESTRO	390931		2"	2.0 LTS	336
	A3 GLS	93-99	MANGUERA DE FRENOS	380457	DEL DER	19"		420
	A3 GLS	93-99	MANGUERA DE FRENOS	380457	DEL IZQ	19"		420
	A3 GLS	93-99	MANGUERA DE FRENOS	7007M	TRAS IZQ	7 1/4"		516
	A3 GLS	93-99	PISTÓN FRENO DE DISCO	98728	DEL	48.0 mm 1-57/64"		527
	A3 GLS	93-94	REP. CIL. MAESTRO Y DE CLUTCH	90271		22.2 mm 7/8"		558
	A3 GLS	93-99	REPUESTO FRENO DE DISCO	124	DEL	48.0 mm 1-57/64"		536
	A3 GTI	93-96	CILINDRO MAESTRO	390060		13/16"	S/ABS 2.0 LTS	300
	A3 GTI	93-96	CILINDRO MAESTRO	390271		7/8"		307
	A3 GTI	95-99	CILINDRO MAESTRO	390432		7/8"	C/ABS	313
	A3 GTI	93-94	CILINDRO MAESTRO	390931		2"		336
	A3 GTI	97-99	CILINDRO MAESTRO	390931		2"	S/ABS 2.0 LTS	336
	A3 GTI	07-08	CILINDRO MAESTRO	391231		7/8"		351
	A3 GTI	93-98	MANGUERA DE FRENOS	38168	TRAS DER	7.38"		389
	A3 GTI	93-98	MANGUERA DE FRENOS	380457	DEL DER	19"		420
	A3 GTI	93-98	MANGUERA DE FRENOS	380457	DEL IZQ	19"		420
	A3 GTI	93-98	MANGUERA DE FRENOS	381103	TRAS DER	6.58"		433
	A3 GTI	93-98	MANGUERA DE FRENOS	381103	TRAS IZQ	6.58"		433
	A3 GTI	07-08	MANGUERA DE FRENOS	382497	TRAS DER	10.08"		467
	A3 GTI	07-08	MANGUERA DE FRENOS	382497	TRAS IZQ	10.08"		467
	A3 GTI	99-99	PISTÓN FRENO DE DISCO	2902	DEL	54.0 mm 2-1/8"		517
	A3 GTI	07-08	PISTÓN FRENO DE DISCO	85810	DEL	54.0 mm 2-1/8"		526
	A3 GTI	93-98	PISTÓN FRENO DE DISCO	85860	DEL	54.0 mm 2-1/8"		527
	A3 GTI	93-98	REP. CIL. MAESTRO Y DE CLUTCH	193		20.6 mm 13/16"		556
	A3 GTI	93-96	REP. CIL. MAESTRO Y DE CLUTCH	90271		22.2 mm 7/8"		558
	A3 GTI	93-99	REPUESTO FRENO DE DISCO	1449	DEL	54.0 mm 2-1/8"		537
	A3 GTI	93-98	REPUESTO FRENO DE DISCO	2103	TRAS	38.1 mm 1-1/2"		539
	A3 GTI	07-08	REPUESTO FRENO DE DISCO	2810	DEL	54.0 mm 2-1/8"		543
	A3 GTI VR6	95-99	CILINDRO MAESTRO	390271		7/8"	VIN 1HS087670 2.8 LTS	307
	A3 GTI VR6	95-99	CILINDRO MAESTRO	390432		7/8"	C/ABS	313

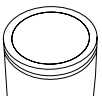



Modelo	Versión	Año	Descripción	Número Lusac	Posición	Diámetro	Notas	Foto Pág.
GOLF	A3 GTI VR6	96-98	MANGUERA DE FRENOS	38168	TRAS DER	7.38"		389
	A3 GTI VR6	95-95	MANGUERA DE FRENOS	380457	DEL DER	19"		420
	A3 GTI VR6	95-95	MANGUERA DE FRENOS	380457	DEL IZQ	19"		420
	A3 GTI VR6	96-98	MANGUERA DE FRENOS	381019	DEL DER	19.33"		431
	A3 GTI VR6	96-98	MANGUERA DE FRENOS	381019	DEL IZQ	19.33"		431
	A3 GTI VR6	96-98	MANGUERA DE FRENOS	381103	TRAS DER	6.58"		433
	A3 GTI VR6	96-98	MANGUERA DE FRENOS	381103	TRAS IZQ	6.58"		433
	A3 GTI VR6	95-99	PISTÓN FRENO DE DISCO	2902	DEL	54.0 mm 2-1/8"		517
	A3 GTI VR6	95-99	PISTÓN FRENO DE DISCO	85860	DEL	54.0 mm 2-1/8"		527
	A3 GTI VR6	95-99	REP. CIL. MAESTRO Y DE CLUTCH	90271		22.2 mm 7/8"		558
	A3 GTI VR6	95-99	REPUESTO FRENO DE DISCO	1449	DEL	54.0 mm 2-1/8"		537
	A3 GTI VR6	95-99	REPUESTO FRENO DE DISCO	2103	TRAS	38.1 mm 1-1/2"		539
	A4	00-07	CILINDRO MAESTRO	390500		15/16"	S/ABS 2.0 LTS	316
	A4	00-07	CILINDRO MAESTRO	390925		15/16"		335
	A4	00-07	CILINDRO MAESTRO	IJ1614019		23.8 mm 15/16"		363
	A4	00-07	MANGUERA DE FRENOS	381103	TRAS IZQ	6.58"		433
	A4	00-05	PISTÓN FRENO DE DISCO	2902	DEL	54.0 mm 2-1/8"		517
	A4	06-07	PISTÓN FRENO DE DISCO	85810	DEL	54.0 mm 2-1/8"		526
	A4	00-05	REPUESTO FRENO DE DISCO	1449	DEL	54.0 mm 2-1/8"		537
	A4	06-07	REPUESTO FRENO DE DISCO	2810	DEL	54.0 mm 2-1/8"		543
	A4 CABRIO	02-02	CILINDRO MAESTRO	390271		7/8"	2.0 LTS	307
	A4 CABRIO	00-01	CILINDRO MAESTRO	390663		15/16"	ESP	322
	A4 CABRIO	00-02	CILINDRO MAESTRO	390931		2"		336
	A4 CABRIO	00-01	MANGUERA DE FRENOS	380457	DEL DER	19"		420
	A4 CABRIO	00-01	MANGUERA DE FRENOS	380457	DEL IZQ	19"		420
	A4 CABRIO	00-01	MANGUERA DE FRENOS	381103	TRAS DER	6.58"		433
	A4 CABRIO	00-01	MANGUERA DE FRENOS	381103	TRAS IZQ	6.58"		433
	A4 CABRIO	00-02	PISTÓN FRENO DE DISCO	85860	DEL	54.0 mm 2-1/8"		527
	A4 CABRIO	02-02	REP. CIL. MAESTRO Y DE CLUTCH	90271		22.2 mm 7/8"		558
	A4 CABRIO	00-02	REPUESTO FRENO DE DISCO	1449	DEL	54.0 mm 2-1/8"		537
	A4 CABRIO	00-02	REPUESTO FRENO DE DISCO	2103	TRAS	38.1 mm 1-1/2"		539
	A4 GTI	00-05	CILINDRO MAESTRO	390500		15/16"	S/ABS 2.0 LTS	316
	A4 GTI	00-05	CILINDRO MAESTRO	IJ1614019		23.8 mm 15/16"	S/ABS 2.0 LTS	363
	A4 GTI	00-05	MANGUERA DE FRENOS	381103	TRAS IZQ	6.58"		433
	A4 GTI	00-05	PISTÓN FRENO DE DISCO	2902	DEL	54.0 mm 2-1/8"		517
	A4 GTI	00-05	REPUESTO FRENO DE DISCO	1449	DEL	54.0 mm 2-1/8"		537
	A5 GTI	07-13	CILINDRO MAESTRO	391231		7/8"		351
	A5 GTI	07-13	CILINDRO MAESTRO	391390		N/D		358
	A5 GTI	07-13	MANGUERA DE FRENOS	382497	TRAS DER	10.08"		467
	A5 GTI	07-13	MANGUERA DE FRENOS	382497	TRAS IZQ	10.08"		467
	A5 GTI	07-13	PISTÓN FRENO DE DISCO	85810	DEL	54.0 mm 2-1/8"		526
	A5 GTI	07-13	REPUESTO FRENO DE DISCO	2810	DEL	54.0 mm 2-1/8"		543

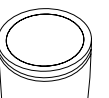



Modelo	Versión	Año	Descripción	Número Lusac	Posición	Diámetro	Notas	Foto Pág.
VOLKSWAGEN								
GOLF	SPORT WAGEN	14-14	CILINDRO MAESTRO	390921RL		22.2 mm 7/8"		362
		93-95	CILINDRO MAESTRO	390167		23.8 mm 15/16"		301
		87-99	KIT DE PISTÓN Y REPUESTO FD	742386	DEL	48.0 mm 1-57/64"		
		95-02	KIT DE PISTÓN Y REPUESTO FD	742389	DEL	54.0 mm 2-1/8"	6 VR	
		99-05	KIT DE PISTÓN Y REPUESTO FD	742393	DEL	54.0 mm 2-1/8"	2.0 S/ABS	
JETTA		93-99	MANGUERA DE FRENOS	6031	DEL DER	13 1/4"		387
		93-99	MANGUERA DE FRENOS	6031	DEL IZQ	13 1/4"		387
		93-98	MANGUERA DE FRENOS	38168	TRAS DER	7.38"		389
		93-98	MANGUERA DE FRENOS	380457	DEL DER	19"		420
		93-98	MANGUERA DE FRENOS	380457	DEL IZQ	19"		420
		93-99	MANGUERA DE FRENOS	381103	TRAS DER	6.58"		433
		93-99	MANGUERA DE FRENOS	381103	TRAS IZQ	6.58"		433
		93-99	PISTÓN FRENO DE DISCO	85860	DEL	54.0 mm 2-1/8"		527
		93-99	PISTÓN FRENO DE DISCO	98728	DEL	48.0 mm 1-57/64"		527
		93-99	REPUESTO FRENO DE DISCO	124	DEL	48.0 mm 1-57/64"		536
		93-99	REPUESTO FRENO DE DISCO	1449	DEL	54.0 mm 2-1/8"		537
		93-99	REPUESTO FRENO DE DISCO	2103	TRAS	38.1 mm 1-1/2"		539
	A2	87-92	CILINDRO DE RUEDA	96399	DER	17.4 mm 11/16"		371
	A2	87-92	CILINDRO DE RUEDA	96399	IZQ	17.4 mm 11/16"		371
	A2	87-91	CILINDRO MAESTRO	110983		20.6 mm 13/16"	1.8 LTS, GLI	298
	A2	88-92	CILINDRO MAESTRO	390060		13/16"		300
	A2	88-92	CILINDRO MAESTRO	390921RL		22.2 mm 7/8"		362
	A2	88-92	MANGUERA DE FRENOS	6031	DEL DER	13 1/4"		387
	A2	88-92	MANGUERA DE FRENOS	6031	DEL IZQ	13 1/4"		387
	A2	87-87	MANGUERA DE FRENOS	38300	DEL DER	13.88"		
	A2	87-87	MANGUERA DE FRENOS	38300	DEL IZQ	13.88"		
	A2	87-92	MANGUERA DE FRENOS	7007M	TRAS IZQ	7 1/4"		516
	A2	87-92	PISTÓN FRENO DE DISCO	98728	DEL	48.0 mm 1-57/64"		527
	A2	87-91	REP. CIL. MAESTRO Y DE CLUTCH	194		20.6 mm 13/16"		556
	A2	87-92	REPUESTO FRENO DE DISCO	124	DEL	48.0 mm 1-57/64"		536
	A3 CL, A3 GL	93-99	CILINDRO DE RUEDA	37986	DER	3/4"		369
	A3 CL, A3 GL	93-99	CILINDRO DE RUEDA	37986	IZQ	3/4"		369
	A3 CL, A3 GL	97-99	CILINDRO MAESTRO	110983		20.6 mm 13/16"	CIL ATE 1.8 LTS, CIL ATE	298
	A3 CL, A3 GL	93-96	CILINDRO MAESTRO	390271		7/8"	CIL ATE 1.8 LTS	307
	A3 CL, A3 GL	93-99	REP. CIL. MAESTRO Y DE CLUTCH	193		20.6 mm 13/16"		556
	A3 CL, A3 GL	97-99	REP. CIL. MAESTRO Y DE CLUTCH	194		20.6 mm 13/16"		556
	A3 CL, A3 GL	93-96	REP. CIL. MAESTRO Y DE CLUTCH	90271		22.2 mm 7/8"		558
A3 GLS, A3 EUROPA	93-98	CILINDRO DE RUEDA	37986	DER	3/4"		369	
A3 GLS, A3 EUROPA	93-98	CILINDRO DE RUEDA	37986	IZQ	3/4"		369	

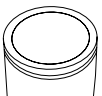



Modelo	Versión	Año	Descripción	Número Lusac	Posición	Diámetro	Notas	Foto Pág.
JETTA	A3 GLS, A3 EUROPA	94-96	CILINDRO MAESTRO	390060		13/16"	2.0 LTS	300
	A3 GLS, A3 EUROPA	93-93	CILINDRO MAESTRO	390271		7/8"		307
	A3 GLS, A3 EUROPA	93-93	CILINDRO MAESTRO	390931		2"	2.0 LTS	336
	A3 GLS, A3 EUROPA	97-99	CILINDRO MAESTRO	390931		2"	2.0 LTS	336
	A3 GLS, A3 EUROPA	93-93	CILINDRO MAESTRO	390921RL		22.2 mm 7/8"		362
	A3 GLS, A3 EUROPA	93-98	REP. CIL. MAESTRO Y DE CLUTCH	193		20.6 mm 13/16"		556
	A3 GLS, A3 EUROPA	93-93	REP. CIL. MAESTRO Y DE CLUTCH	90271		22.2 mm 7/8"		558
	A3 VR6	95-99	CILINDRO MAESTRO	390271		7/8"	2.8 LTS	307
	A3 VR6	95-99	CILINDRO MAESTRO	390432		7/8"	C/ABS	313
	A3 VR6	96-98	MANGUERA DE FRENOS	38168	TRAS DER	7.38"		389
	A3 VR6	96-98	MANGUERA DE FRENOS	381019	DEL DER	19.33"		431
	A3 VR6	96-98	MANGUERA DE FRENOS	381019	DEL IZQ	19.33"		431
	A3 VR6	96-98	MANGUERA DE FRENOS	381103	TRAS IZQ	6.58"		433
	A3 VR6	95-99	PISTÓN FRENO DE DISCO	2902	DEL	54.0 mm 2-1/8"		517
	A3 VR6	99-99	PISTÓN FRENO DE DISCO	85810	DEL	54.0 mm 2-1/8"		526
	A3 VR6	95-99	REP. CIL. MAESTRO Y DE CLUTCH	90271		22.2 mm 7/8"		558
	A3 VR6	95-99	REPUESTO FRENO DE DISCO	1449	DEL	54.0 mm 2-1/8"		537
	A3 VR6	95-99	REPUESTO FRENO DE DISCO	2103	TRAS	38.1 mm 1-1/2"		539
	A3 VR6	99-99	REPUESTO FRENO DE DISCO	2810	DEL	54.0 mm 2-1/8"		543
	A4	08-10	CILINDRO DE RUEDA	370115	IZQ	13/16"		377
	A4	08-10	CILINDRO DE RUEDA	370115	DER	13/16"		377
	A4	00-05	CILINDRO MAESTRO	390500		15/16"	2.0 LTS	316
	A4	09-13	CILINDRO MAESTRO	390925		15/16"		335
	A4	00-05	CILINDRO MAESTRO	390925		15/16"	C/C DE ESTABILIDAD (ESP)	335
	A4	08-13	CILINDRO MAESTRO	391092		15/16"		342
	A4	00-07	CILINDRO MAESTRO	IJ1614019		23.8 mm 15/16"		363
	A4	00-13	PISTÓN FRENO DE DISCO	2902	DEL	54.0 mm 2-1/8"		517
	A4	00-05	PISTÓN FRENO DE DISCO	85810	DEL	54.0 mm 2-1/8"		526
	A4	09-13	PISTÓN FRENO DE DISCO	85810	DEL	54.0 mm 2-1/8"		526
	A4	00-13	REPUESTO FRENO DE DISCO	1449	DEL	54.0 mm 2-1/8"		537
	A4	00-05	REPUESTO FRENO DE DISCO	2183	TRAS	40.0 mm		
	A4	09-13	REPUESTO FRENO DE DISCO	2183	TRAS	40.0 mm		
	A4	00-05	REPUESTO FRENO DE DISCO	2810	DEL	54.0 mm 2-1/8"		543
	A4	09-13	REPUESTO FRENO DE DISCO	2810	DEL	54.0 mm 2-1/8"		543
	A4 EUROPA	02-08	CILINDRO MAESTRO	390500		15/16"		316
	A4 EUROPA	02-10	CILINDRO MAESTRO	390925		15/16"		335
	A4 EUROPA	09-10	CILINDRO MAESTRO	391092		15/16"		342
	A4 EUROPA	02-10	PISTÓN FRENO DE DISCO	85810	DEL	54.0 mm 2-1/8"		526





Modelo	Versión	Año	Descripción	Número Lusac	Posición	Diámetro	Notas	Foto Pág.
VOLKSWAGEN								
JETTA	A4 EUROPA	02-10	REPUESTO FRENO DE DISCO	2183	TRAS	40.0 mm		
	A4 EUROPA	02-10	REPUESTO FRENO DE DISCO	2810	DEL	54.0 mm 2-1/8"		543
	A4 TDI	06-08	CILINDRO MAESTRO	390500		15/16"		316
	A4 TDI	06-08	CILINDRO MAESTRO	390925		15/16"		335
	A4 TDI	06-08	PISTÓN FRENO DE DISCO	85810	DEL	54.0 mm 2-1/8"		526
	A4 TDI	06-08	REPUESTO FRENO DE DISCO	2183	TRAS	40.0 mm		
	A4 TDI	06-08	REPUESTO FRENO DE DISCO	2810	DEL	54.0 mm 2-1/8"		543
	A4 TRENDLINE	02-08	CILINDRO MAESTRO	390500		15/16"		316
	A4 TRENDLINE	02-08	CILINDRO MAESTRO	390925		15/16"		335
	A4 TRENDLINE	02-08	PISTÓN FRENO DE DISCO	85810	DEL	54.0 mm 2-1/8"		526
	A4 TRENDLINE	02-08	REPUESTO FRENO DE DISCO	2183	TRAS	40.0 mm		
	A4 TRENDLINE	02-08	REPUESTO FRENO DE DISCO	2810	DEL	54.0 mm 2-1/8"		543
	A4, BASE, EURO-PA, TDI, TRENDLINE	06-07	CILINDRO MAESTRO	390500		15/16"	2.0 LTS	316
	A4, BASE, EURO-PA, TDI, TRENDLINE	06-08	CILINDRO MAESTRO	390925		15/16"		335
	A4, BASE, EURO-PA, TDI, TRENDLINE	06-08	PISTÓN FRENO DE DISCO	85810	DEL	54.0 mm 2-1/8"		526
	A4, BASE, EURO-PA, TDI, TRENDLINE	06-08	REPUESTO FRENO DE DISCO	2183	TRAS	40.0 mm		
	A4, BASE, EURO-PA, TDI, TRENDLINE	06-08	REPUESTO FRENO DE DISCO	2810	DEL	54.0 mm 2-1/8"		543
	A6	11-13	CILINDRO MAESTRO	391232		7/8"		351
	CLASICO	10-14	CILINDRO DE RUEDA	370115	IZQ	13/16"		377
	CLASICO	10-14	CILINDRO MAESTRO	390925		15/16"		335
	CLASICO	10-14	CILINDRO MAESTRO	391092		15/16"		342
	CLASICO	10-14	PISTÓN FRENO DE DISCO	85810	DEL	54.0 mm 2-1/8"		526
	CLASICO	10-14	REPUESTO FRENO DE DISCO	2810	DEL	54.0 mm 2-1/8"		543
	10-14	CILINDRO DE RUEDA	370113	TRAS DER	19.0 mm 3/4"		377	

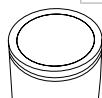



Modelo	Versión	Año	Descripción	Número Lusac	Posición	Diámetro	Notas	Foto Pág.
LUPO		10-14	CILINDRO DE RUEDA	370113	TRAS IZQ	19.0 mm 3/4"		377
		93-95	CILINDRO MAESTRO	390167		23.8 mm 15/16"	AUTOMÁTICA	301
		87-99	KIT DE PISTÓN Y REPUESTO FD	742386	DEL	48.0 mm 1-57/64"		
		93-99	KIT DE PISTÓN Y REPUESTO FD	742389	DEL	54.0 mm 2-1/8"		
		95-10	KIT DE PISTÓN Y REPUESTO FD	742393	DEL	54.0 mm 2-1/8"	2.8 6 VR	
		05-09	PISTÓN FRENO DE DISCO	2902	DEL	54.0 mm 2-1/8"		517
		05-09	REPUESTO FRENO DE DISCO	1449	DEL	54.0 mm 2-1/8"		537
		05-09	CILINDRO DE RUEDA	37986	IZQ	3/4"		369
		08-09	CILINDRO MAESTRO	39009912		3/4"	C/ABS 1.6 LTS	361
		05-07	KIT DE PISTÓN Y REPUESTO FD	742393	DEL	54.0 mm 2-1/8"		
NEW BEETLE		98-05	CILINDRO MAESTRO	390500		15/16"	SISTEMA BOSCH; S/C DE ESTABILIDAD	316
		02-10	CILINDRO MAESTRO	390925		15/16"	C/C DE ESTABILIDAD	335
		02-10	CILINDRO MAESTRO	391092		15/16"	S/C DE ESTABILIDAD; SISTEMA ATE	342
		12-13	CILINDRO MAESTRO	391232		7/8"		351
PANEL		73-01	CILINDRO DE RUEDA	96387	DER	23.8 mm 15/16"		371
		73-01	CILINDRO DE RUEDA	96387	IZQ	23.8 mm 15/16"		371
		73-88	CILINDRO MAESTRO	390951RL		20.6 mm 13/16"		
		88-01	MANGUERA DE FRENOS	6024	TRAS IZQ	11"		387
		73-88	MANGUERA DE FRENOS	7006	DEL DER	13 1/4"		
		73-88	MANGUERA DE FRENOS	7006	DEL IZQ	13 1/4"		
		88-01	MANGUERA DE FRENOS	7010	DEL DER	13 1/4"		387
		88-01	MANGUERA DE FRENOS	7010	DEL IZQ	13 1/4"		387
		73-88	MANGUERA DE FRENOS	7005M	TRAS IZQ	10 3/4"		516
		73-01	PISTÓN FRENO DE DISCO	96373	DEL	54.0 mm 2-1/8"		527
		73-88	REP. CIL. MAESTRO Y DE CLUTCH	151		20.5 mm		
		88-01	REP. CIL. MAESTRO Y DE CLUTCH	152		23.8 mm 15/16"		556
		73-01	REPUESTO FRENO DE DISCO	126	DEL	54.0 mm 2-1/8"		536
PASSAT		91-93	MANGUERA DE FRENOS	38168	TRAS DER	7.38"		389
		99-05	MANGUERA DE FRENOS	380452	TRAS DER	8.75"		420
		99-05	MANGUERA DE FRENOS	380452	TRAS IZQ	8.75"		420





Modelo	Versión	Año	Descripción	Número Lusac	Posición	Diámetro	Notas	Foto Pág.	
VOLKSWAGEN									
PASSAT		91-93	MANGUERA DE FRENOS	380456	DEL DER	14"		420	
		91-93	MANGUERA DE FRENOS	380456	DEL IZQ	14"		420	
		96-97	MANGUERA DE FRENOS	381116	DEL DER	12.75"		434	
		99-05	MANGUERA DE FRENOS	381116	DEL DER	12.75"		434	
		96-97	MANGUERA DE FRENOS	381116	DEL IZQ	12.75"		434	
		99-05	MANGUERA DE FRENOS	381116	DEL IZQ	12.75"		434	
		02-05	MANGUERA DE FRENOS	381503	TRAS DER	7.82"		447	
		02-05	MANGUERA DE FRENOS	381503	TRAS IZQ	7.82"		447	
		06-11	MANGUERA DE FRENOS	382497	TRAS DER	10.08"		467	
		06-11	MANGUERA DE FRENOS	382497	TRAS IZQ	10.08"		467	
		06-10	PISTÓN FRENO DE DISCO	85391	DEL	57.1 mm 2-1/4"		523	
		91-93	PISTÓN FRENO DE DISCO	85860	DEL	54.0 mm 2-1/8"		527	
		96-97	PISTÓN FRENO DE DISCO	85860	DEL	54.0 mm 2-1/8"		527	
		99-05	PISTÓN FRENO DE DISCO	85860	DEL	54.0 mm 2-1/8"		527	
		91-93	REPUESTO FRENO DE DISCO	1449	DEL	54.0 mm 2-1/8"		537	
		96-97	REPUESTO FRENO DE DISCO	1449	DEL	54.0 mm 2-1/8"		537	
		99-01	REPUESTO FRENO DE DISCO	1449	DEL	54.0 mm 2-1/8"		537	
		91-93	REPUESTO FRENO DE DISCO	2103	TRAS	38.1 mm 1-1/2"		539	
		96-97	REPUESTO FRENO DE DISCO	2103	TRAS	38.1 mm 1-1/2"		539	
		99-05	REPUESTO FRENO DE DISCO	2103	TRAS	38.1 mm 1-1/2"		539	
		96-97	REPUESTO FRENO DE DISCO	2801	DEL	54.0 mm 2-1/8"			
		99-05	REPUESTO FRENO DE DISCO	2801	DEL	54.0 mm 2-1/8"			
		CC	12-13	MANGUERA DE FRENOS	382497	TRAS DER	10.08"		467
		CC	12-13	MANGUERA DE FRENOS	382497	TRAS IZQ	10.08"		467
		V6	06-08	MANGUERA DE FRENOS	382497	TRAS DER	10.08"		467
		V6	06-08	MANGUERA DE FRENOS	382497	TRAS IZQ	10.08"		467
		V6	06-08	PISTÓN FRENO DE DISCO	85391	DEL	57.1 mm 2-1/4"		523
		VAGONETA	91-92	CILINDRO MAESTRO	390931		2"		336
		VAGONETA	91-92	MANGUERA DE FRENOS	38168	TRAS DER	7.38"		389

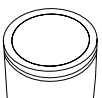

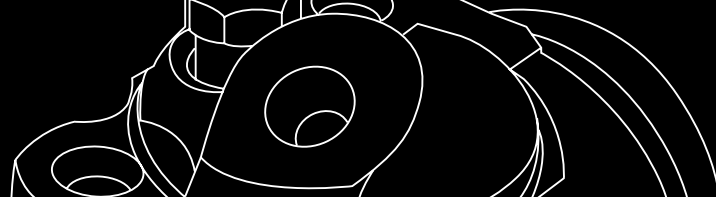

Modelo	Versión	Año	Descripción	Número Lusac	Posición	Diámetro	Notas	Foto Pág.
PASSAT	VAGONETA	91-92	MANGUERA DE FRENOS	380456	DEL DER	14"		420
	VAGONETA	91-92	MANGUERA DE FRENOS	380456	DEL IZQ	14"		420
	VAGONETA	91-92	PISTÓN FRENO DE DISCO	85860	DEL	54.0 mm 2-1/8"		527
	VAGONETA	91-92	REPUESTO FRENO DE DISCO	1449	DEL	54.0 mm 2-1/8"		537
	VAGONETA	91-92	REPUESTO FRENO DE DISCO	2103	TRAS	38.1 mm 1-1/2"		539
	VAGONE-TA VR6	96-97	CILINDRO MAESTRO	390271		7/8"		307
	VAGONE-TA VR6	96-97	CILINDRO MAESTRO	390433		1"		313
	VAGONE-TA VR6	96-97	CILINDRO MAESTRO	390931		2"		336
	VAGONE-TA VR6	96-97	MANGUERA DE FRENOS	38168	TRAS DER	7.38"		389
	VAGONE-TA VR6	96-97	MANGUERA DE FRENOS	381389	DEL DER	16.35"		446
	VAGONE-TA VR6	96-97	MANGUERA DE FRENOS	381389	DEL IZQ	16.35"		446
	VAGONE-TA VR6	96-97	MANGUERA DE FRENOS	7007M	TRAS IZQ	7 1/4"		516
	VAGONE-TA VR6	96-97	PISTÓN FRENO DE DISCO	2902	DEL	54.0 mm 2-1/8"		517
	VAGONE-TA VR6	96-97	REP. CIL. MAESTRO Y DE CLUTCH	90271		22.2 mm 7/8"		558
	VAGONE-TA VR6	96-97	REPUESTO FRENO DE DISCO	1449	DEL	54.0 mm 2-1/8"		537
	VAGONE-TA VR6	96-97	REPUESTO FRENO DE DISCO	2103	TRAS	38.1 mm 1-1/2"		539
	VR6	96-97	CILINDRO MAESTRO	390271		7/8"		307
	VR6	96-97	CILINDRO MAESTRO	390433		1"	C/ABS	313
	VR6	96-97	CILINDRO MAESTRO	390931		2"		336
	VR6	96-97	MANGUERA DE FRENOS	38168	TRAS DER	7.38"		389
	VR6	96-97	MANGUERA DE FRENOS	381389	DEL DER	16.35"		446
	VR6	96-97	MANGUERA DE FRENOS	381389	DEL IZQ	16.35"		446
	VR6	96-97	MANGUERA DE FRENOS	7007M	TRAS IZQ	7 1/4"		516
	VR6	96-97	PISTÓN FRENO DE DISCO	2902	DEL	54.0 mm 2-1/8"		517
	VR6	96-97	REP. CIL. MAESTRO Y DE CLUTCH	90271		22.2 mm 7/8"		558
	VR6	96-97	REPUESTO FRENO DE DISCO	1449	DEL	54.0 mm 2-1/8"		537
VR6	96-97	REPUESTO FRENO DE DISCO	2103	TRAS	38.1 mm 1-1/2"		539	

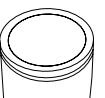



Modelo	Versión	Año	Descripción	Número Lusac	Posición	Diámetro	Notas	Foto Pág.
VOLKSWAGEN								
PASSAT	W8	03-05	CILINDRO MAESTRO	390778		1"	4-MOTION	327
	W8	03-05	MANGUERA DE FRENOS	382497	TRAS DER	10.08"		467
	W8	03-05	MANGUERA DE FRENOS	382497	TRAS IZQ	10.08"		467
		95-97	CILINDRO DE CLUTCH	350071		19.0 mm 3/4"	NACIONAL	
		95-95	CILINDRO MAESTRO	390167		23.8 mm 15/16"		301
		00-01	CILINDRO MAESTRO	390613		1"		320
		02-05	CILINDRO MAESTRO	390778		1"		327
		91-93	CILINDRO MAESTRO	390931		2"		336
	2.0 LTS.	09-11	CILINDRO MAESTRO	391233		7/8"	2.0 LTS	351
	3.6 LTS.	08-10	CILINDRO MAESTRO	391233		7/8"	3.6 LTS	351
	4-MOTION	06-07	CILINDRO MAESTRO	391233		7/8"	4-MOTION	351
		12-14	CILINDRO MAESTRO	391390		N/D	CIL TEVES	358
		91-93	CILINDRO MAESTRO	390921RL		22.2 mm 7/8"	IMPORTADO	362
		91-93	KIT DE PISTÓN Y REPUESTO FD	742389	DEL	54.0 mm 2-1/8"		
		99-05	KIT DE PISTÓN Y REPUESTO FD	742391	DEL	54.0 mm 2-1/8"		
		96-97	KIT DE PISTÓN Y REPUESTO FD	742393	DEL	54.0 mm 2-1/8"	6 VR	
		98-98	MANGUERA DE FRENOS	381116	DEL IZQ DER	12.75"		434
POINTER		98-99	PISTÓN FRENO DE DISCO	2900	DEL	48.0 mm 1-57/64"		517
		98-99	PISTÓN FRENO DE DISCO	2904	DEL	54.0 mm 2-1/8"		517
		03-09	PISTÓN FRENO DE DISCO	2904	DEL	54.0 mm 2-1/8"		517
		98-99	REPUESTO FRENO DE DISCO	2901	DEL	48.0 mm 1-57/64"		545
		98-99	REPUESTO FRENO DE DISCO	102443	DEL	54.0 mm 2-1/8"		554
		03-09	REPUESTO FRENO DE DISCO	102443	DEL	54.0 mm 2-1/8"		554
	CITY	00-02	CILINDRO DE RUEDA	370301	DER	19.0 mm 3/4"		382
	CITY	00-02	CILINDRO DE RUEDA	370301	IZQ	19.0 mm 3/4"		382
	CITY	00-02	CILINDRO MAESTRO	390901RL		20.6 mm 13/16"		362
	CITY	00-02	PISTÓN FRENO DE DISCO	2900	DEL	48.0 mm 1-57/64"		517
	CITY	00-02	PISTÓN FRENO DE DISCO	2904	DEL	54.0 mm 2-1/8"		517
	CITY	00-02	REP. CIL. MAESTRO Y DE CLUTCH	90901		20.6 mm 13/16"		560

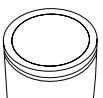



Modelo	Versión	Año	Descripción	Número Lusac	Posición	Diámetro	Notas	Foto Pág.	
POINTER	CITY	00-02	REPUESTO FRENO DE DISCO	2901	DEL	48.0 mm 1-57/64"		545	
	CITY	00-02	REPUESTO FRENO DE DISCO	102443	DEL	54.0 mm 2-1/8"		554	
	GTI	00-03	PISTÓN FRENO DE DISCO	2904	DEL	54.0 mm 2-1/8"		517	
	GTI	00-03	REPUESTO FRENO DE DISCO	102443	DEL	54.0 mm 2-1/8"		554	
	INC CITY, GTI, VAGONETA	00-02	PISTÓN FRENO DE DISCO	2904	DEL	54.0 mm 2-1/8"		517	
	INC CITY, GTI, VAGONETA	00-02	REPUESTO FRENO DE DISCO	102443	DEL	54.0 mm 2-1/8"		554	
	INC CITY, PICK UP, VAGONETA	00-02	PISTÓN FRENO DE DISCO	2900	DEL	48.0 mm 1-57/64"		517	
	INC CITY, PICK UP, VAGONETA	00-02	REPUESTO FRENO DE DISCO	2901	DEL	48.0 mm 1-57/64"		545	
	MI, CITY	03-08	CILINDRO DE RUEDA	370301	DER	19.0 mm 3/4"		382	
	MI, CITY	03-08	CILINDRO DE RUEDA	370301	IZQ	19.0 mm 3/4"		382	
	PICKUP	99-07	PISTÓN FRENO DE DISCO	2900	DEL	48.0 mm 1-57/64"		517	
	PICKUP	99-07	REPUESTO FRENO DE DISCO	2901	DEL	48.0 mm 1-57/64"		545	
	PICKUP TRENDLINE	02-10	PISTÓN FRENO DE DISCO	2900	DEL	48.0 mm 1-57/64"		517	
	PICKUP TRENDLINE	02-10	REPUESTO FRENO DE DISCO	2901	DEL	48.0 mm 1-57/64"		545	
	VAGONETA	99-05	CILINDRO DE RUEDA	370301	DER	19.0 mm 3/4"		382	
	VAGONETA	99-05	CILINDRO DE RUEDA	370301	IZQ	19.0 mm 3/4"		382	
	VAGONETA	99-02	CILINDRO MAESTRO	390901RL		20.6 mm 13/16"		362	
	VAGONETA	99-02	PISTÓN FRENO DE DISCO	2900	DEL	48.0 mm 1-57/64"		517	
	VAGONETA	99-05	PISTÓN FRENO DE DISCO	2904	DEL	54.0 mm 2-1/8"		517	
	VAGONETA	99-02	PISTÓN FRENO DE DISCO	85812	DEL	54.0 mm 2-1/8"		526	
	VAGONETA	99-02	REP. CIL. MAESTRO Y DE CLUTCH	90901		20.6 mm 13/16"		560	
	VAGONETA	99-02	REPUESTO FRENO DE DISCO	2901	DEL	48.0 mm 1-57/64"		545	
	VAGONETA	98-00	REPUESTO FRENO DE DISCO	21067	DEL	54.0 mm 2-1/8"		550	
	VAGONETA	99-05	REPUESTO FRENO DE DISCO	102443	DEL	54.0 mm 2-1/8"		554	
			98-09	CILINDRO DE RUEDA	96399	DER	17.4 mm 11/16"		371





Modelo	Versión	Año	Descripción	Número Lusac	Posición	Diámetro	Notas	Foto Pág.
VOLKSWAGEN								
POLO		98-09	CILINDRO DE RUEDA	96399	IZQ	17.4 mm 11/16"		371
		98-09	CILINDRO DE RUEDA	370301	DER	19.0 mm 3/4"		382
		98-09	CILINDRO DE RUEDA	370301	IZQ	19.0 mm 3/4"		382
		98-02	CILINDRO MAESTRO	390901RL		20.6 mm 13/16"	1.8 LTS	362
		03-10	KIT DE PISTÓN Y REPUESTO FD	742388	DEL	54.0 mm 2-1/8"	2	
		98-02	REP. CIL. MAESTRO Y DE CLUTCH	90901		20.6 mm 13/16"		560
	PICKUP	99-07	KIT DE PISTÓN Y REPUESTO FD	742394	DEL	48.0 mm 1-57/64"		
		03-07	CILINDRO DE RUEDA	37986	DER	3/4"		369
		03-07	CILINDRO DE RUEDA	37986	IZQ	3/4"		369
		03-07	KIT DE PISTÓN Y REPUESTO FD	742393	DEL	54.0 mm 2-1/8"		
		03-07	PISTÓN FRENO DE DISCO	2902	DEL	54.0 mm 2-1/8"		517
		03-07	REPUESTO FRENO DE DISCO	1449	DEL	54.0 mm 2-1/8"		537
R32		04-04	CILINDRO MAESTRO	390925		15/16"	3.2 LTS	335
ROUTAN		09-13	MANGUERA DE FRENOS	382519	DER	17.5"		469
		09-13	MANGUERA DE FRENOS	382520	IZQ	17.5"		469
		09-10	MANGUERA DE FRENOS	382521	TRAS IZQ	17.5"		469
		09-10	MANGUERA DE FRENOS	382522	TRAS DER	17.5"		469
SAVEIRO		10-14	PISTÓN FRENO DE DISCO	851005	DEL	48.0 mm 1-57/64"		530
		10-14	REPUESTO FRENO DE DISCO	2901	DEL	48.0 mm 1-57/64"		545
		10-14	CILINDRO MAESTRO	39009911		13/16"	S/ABS	361
		10-14	CILINDRO MAESTRO	39009912		3/4"	C/ABS	361
SEDAN		95-04	MANGUERA DE FRENOS	6027	DEL DER	15 1/16"		387
		73-04	MANGUERA DE FRENOS	6027	DEL IZQ	15 1/16"		387
		73-94	MANGUERA DE FRENOS	6027	DEL IZQ	15 1/16"		387
		73-04	MANGUERA DE FRENOS	7005M	TRAS IZQ	10 3/4"		516
		95-04	PISTÓN FRENO DE DISCO	96363	DEL	40.0 mm		527
		95-04	REPUESTO FRENO DE DISCO	127	DEL	40.0 mm		536
		73-94	CILINDRO DE RUEDA	90549	DER	22.2 mm 7/8"		371
		73-94	CILINDRO DE RUEDA	90549	IZQ	22.2 mm 7/8"		371
		73-04	CILINDRO DE RUEDA	93356	DER	17.4 mm 11/16"		371
		73-04	CILINDRO DE RUEDA	93356	IZQ	17.4 mm 11/16"		371





Modelo	Versión	Año	Descripción	Número Lusac	Posición	Diámetro	Notas	Foto Pág.
SEDAN		73-91	CILINDRO MAESTRO	90547		17.4 mm 11/16"		296
		92-04	CILINDRO MAESTRO	96415		19.0 mm 3/4"		297
		07-09	KIT DE PISTÓN Y REPUESTO FD	742418	DEL	54.0 mm 2-1/8"		
		73-91	REP. CIL. MAESTRO Y DE CLUTCH	130		17.4 mm 11/16"		556
		92-04	REP. CIL. MAESTRO Y DE CLUTCH	96404-LC		19.0 mm 3/4"		563
SHARAN		02-08	KIT DE PISTÓN Y REPUESTO FD	742400	DEL	57.1 mm 2-1/4"		
		02-08	PISTÓN FRENO DE DISCO	851015	DEL	57.1 mm 2-1/4"		531
		02-08	REPUESTO FRENO DE DISCO	2103	TRAS	38.1 mm 1-1/2"		539
		02-08	REPUESTO FRENO DE DISCO	21015	DEL	57.1 mm 2-1/4"		546
TOUAREG	2	10-10	CILINDRO MAESTRO	391036		27mm		340
VW VAN		03-09	KIT DE PISTÓN Y REPUESTO FD	742386	DEL	48.0 mm 1-57/64"		
		03-09	KIT DE PISTÓN Y REPUESTO FD	742389	DEL	54.0 mm 2-1/8"		
VOLVO								
C70		99-01	MANGUERA DE FRENOS	38002	TRAS DER	8.88"		387
		99-01	MANGUERA DE FRENOS	38002	TRAS IZQ	8.88"		387
		99-01	MANGUERA DE FRENOS	380227	DEL DER	14.13"		409
		99-01	MANGUERA DE FRENOS	380227	DEL IZQ	14.13"		409
		90-00	CILINDRO MAESTRO	390325		50.8 mm 2"		309
		98-01	CILINDRO MAESTRO	390594		1"	C/C DE TRACCIÓN	320
		98-98	MANGUERA DE FRENOS	38002	DEL IZQ DER	8.88"		387
		02-04	MANGUERA DE FRENOS	38002	DEL IZQ DER	8.88"		387
S40		08-10	MANGUERA DE FRENOS	382623	DEL IZQ	12.95"	AWD	477
		08-10	MANGUERA DE FRENOS	382623	DEL DER	12.95"		477
S60	2.4	01-02	MANGUERA DE FRENOS	38514	TRAS	11.94"		392
	2.4	07-07	MANGUERA DE FRENOS	38514	TRAS	11.94"	2.5T AWD	392
	2.4	07-07	MANGUERA DE FRENOS	38514	TRAS	11.94"	2.5T AWD	392
S70		99-00	MANGUERA DE FRENOS	38002	TRAS DER	8.88"		387
		99-00	MANGUERA DE FRENOS	38002	TRAS IZQ	8.88"		387
		99-00	MANGUERA DE FRENOS	380227	DEL DER	14.13"		409
		99-00	MANGUERA DE FRENOS	380227	DEL IZQ	14.13"		409
		99-00	CILINDRO MAESTRO	390594		1"	C/C DE TRACCIÓN	320
S80		99-06	MANGUERA DE FRENOS	38514	TRAS	11.94"		392





Modelo	Versión	Año	Descripción	Número Lusac	Posición	Diámetro	Notas	Foto Pág.
VOLVO								
V70		99-04	MANGUERA DE FRENOS	38002	TRAS DER	8.88"		387
		99-04	MANGUERA DE FRENOS	38002	TRAS IZQ	8.88"		387
		99-04	MANGUERA DE FRENOS	380227	DEL DER	14.13"		409
		99-04	MANGUERA DE FRENOS	380227	DEL IZQ	14.13"		409
		99-04	CILINDRO MAESTRO	390594		1"	C/C DE TRACCIÓN	320
		98-98	MANGUERA DE FRENOS	38002	DEL IZQ DER	8.88"		387
		06-07	MANGUERA DE FRENOS	38514	TRAS	11.94"	2.4	392
		06-07	MANGUERA DE FRENOS	38514	TRAS	11.94"	2.5T	392
		06-06	MANGUERA DE FRENOS	38514	TRAS	11.94"	2.5T AWD	392
		06-06	MANGUERA DE FRENOS	38514	TRAS	11.94"	T5	392
		98-98	MANGUERA DE FRENOS	380227	DEL IZQ DER	14.13"		409
XC70		03-07	MANGUERA DE FRENOS	38514	TRAS	11.94"		392

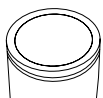



Lusac[®]







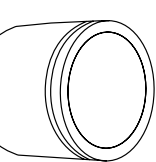



Imágenes por número de parte



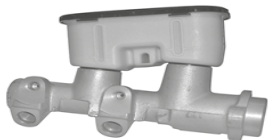

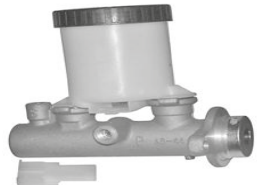
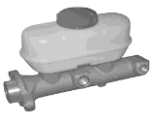
Fotografías de producto y especificaciones

No. Lusac: 39087 Producto: CILINDRO MAESTRO 		No. Lusac: 39276 Producto: CILINDRO MAESTRO 		No. Lusac: 39308 Producto: CILINDRO MAESTRO 	
DIAMETRO	11/16"	DIAMETRO	7/8"	DIAMETRO	30mm
NISSAN PICKUP NISSAN C/CILINDRO NABCO 80-86		NISSAN PICKUP NISSAN C/CILINDRO NABCO 87-90 PICKUP NISSAN C/CILINDRO TOKICO 87-90		CHEVROLET CHEVY VAN 95-95	
No. Lusac: 39406 Producto: CILINDRO MAESTRO 		No. Lusac: 39555 Producto: CILINDRO MAESTRO 		No. Lusac: 39566 Producto: CILINDRO MAESTRO 	
DIAMETRO	3/4" & 15/16"	DIAMETRO	3/4" & 15/16"	DIAMETRO	28.6mm & 40mm
NISSAN HIKARI C/CILINDRO NABCO 88-92 TSURU II C/CILINDRO NABCO 88-92		NISSAN HIKARI C/CILINDRO TOKICO 88-92 TSURU II C/CILINDRO TOKICO 88-92		CADILLAC DEVILLE CONCOURS S/ABS 94-96 DEVILLE S/ABS 91-93	
No. Lusac: 39571 Producto: CILINDRO MAESTRO 		No. Lusac: 39592 Producto: CILINDRO MAESTRO 		No. Lusac: 39593 Producto: CILINDRO MAESTRO 	
DIAMETRO	24mm & 36mm	DIAMETRO	15/16"	DIAMETRO	1"
CHEVROLET BLAZER 4X2 95-95 S-10 95-95 BLAZER 4X4 95-95		NISSAN PICKUP NISSAN 92-92 PICKUP NISSAN 91-91		NISSAN PICKUP NISSAN 94-96 PICKUP (TOKICO) 91-97	
No. Lusac: 39635 Producto: CILINDRO MAESTRO 		No. Lusac: 39646 Producto: CILINDRO MAESTRO 		No. Lusac: 39649 Producto: CILINDRO MAESTRO 	
DIAMETRO	1-1/8"	DIAMETRO	28.6mm & 40mm	DIAMETRO	1-1/4"
FORD F250 C/C DE VELOCIDAD 96-96 F250 94-94 P350 MICROBUS 96-96		CHEVROLET C1500 94-94 C2500 CHEYENNE 94-94 C2500 89-94		DODGE RAM 1500 4X2 94-94 RAM 1500 4X4 94-94 D250 INLUYE CLUB CAB 91-92	
		CHEVROLET C3500 92-94 C3500 91-91		C3500 89-90	

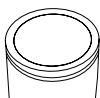

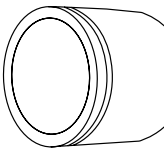

<p>No. Lusac: 39703 Producto: CILINDRO MAESTRO</p> 		<p>No. Lusac: 39716 Producto: CILINDRO MAESTRO</p> 		<p>No. Lusac: 39736 Producto: CILINDRO MAESTRO</p> 	
DIAMETRO	3/4" & 15/16"	DIAMETRO	7/8"	DIAMETRO	7/8"
<p>MERCEDES-BENZ B200 06-09 MERCEDEZ BENZ C220 95-97</p>		<p>CHEVROLET CORVETTE 91-91</p>		<p>DODGE SPIRIT 90-95 SHADOW GTS TURBO 89-89</p>	
<p>No. Lusac: 39772 Producto: CILINDRO MAESTRO</p> 		<p>No. Lusac: 39791 Producto: CILINDRO MAESTRO</p> 		<p>No. Lusac: 39797 Producto: CILINDRO MAESTRO</p> 	
DIAMETRO	15/16"	DIAMETRO	15/16"	DIAMETRO	15/16"
<p>FORD TAURUS 90-90</p>		<p>NISSAN PICKUP NISSAN 97-97</p>		<p>NISSAN MAXIMA 3.6 V S/ABS 92-93 MAXIMA S/ABS 91-91</p>	
<p>No. Lusac: 39799 Producto: CILINDRO MAESTRO</p> 		<p>No. Lusac: 39800 Producto: CILINDRO MAESTRO</p> 		<p>No. Lusac: 39810 Producto: CILINDRO MAESTRO</p> 	
DIAMETRO	1"	DIAMETRO	15/16"	DIAMETRO	7/8"
<p>NISSAN MAXIMA C/ABS 91-93</p>		<p>NISSAN 240SX S/ABS 93-93</p>		<p>NISSAN 240SX S/ABS 98-98 93-93</p>	
<p>No. Lusac: 39862 Producto: CILINDRO MAESTRO</p> 		<p>No. Lusac: 39882 Producto: CILINDRO MAESTRO</p> 		<p>No. Lusac: 39953 Producto: CILINDRO MAESTRO</p> 	
DIAMETRO	1-1/8"	DIAMETRO	15/16"	DIAMETRO	1"
<p>DODGE RAM 3500 MAXI WAGON 95-97 RAM VAN 3500 95-97</p>		<p>HONDA ACCORD 2.2 4 L OHC S/ABS 96-97</p>		<p>FORD EXPLORER SPORT 94-95 EXPLORER 91-94</p>	

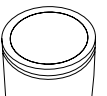

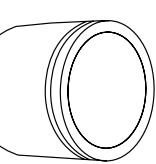





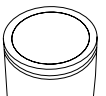

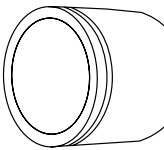
Fotografías de producto y especificaciones

No. Lusac: 39954 Producto: CILINDRO MAESTRO 		No. Lusac: 39955 Producto: CILINDRO MAESTRO 		No. Lusac: 39956 Producto: CILINDRO MAESTRO 	
DIAMETRO	1"	DIAMETRO	1"	DIAMETRO	1"
OLDSMOBILE EIGHTY EIGHT 92-92		CADILLAC DEVILLE CONCOURS C/ABS 94-96 DEVILLE C/ABS 91-93		OLDSMOBILE EIGHTY EIGHT C/ABS 92-92	
				FORD GRAND MARQUIS 92-94 LINCOLN TOWN CAR S/ABS 92-94	
No. Lusac: 39960 Producto: CILINDRO MAESTRO 		No. Lusac: 39962 Producto: CILINDRO MAESTRO 		No. Lusac: 39970 Producto: CILINDRO MAESTRO 	
DIAMETRO	7/8"	DIAMETRO	1"	DIAMETRO	1"
CHEVROLET TRACKER 93-95		CADILLAC DEVILLE 94-94		HONDA ACCORD C/ABS 96-97	
No. Lusac: 39980 Producto: CILINDRO MAESTRO 		No. Lusac: 39981 Producto: CILINDRO MAESTRO 		No. Lusac: 90547 Producto: CILINDRO MAESTRO 	
DIAMETRO	1"	DIAMETRO	15/16"	DIAMETRO	17.4 mm 11/16"
JEEP WRANGLER S/ABS 93-95		JEEP CHEROKEE SPORT S/ABS 94-94		VOLKSWAGEN SEDAN 83-91	

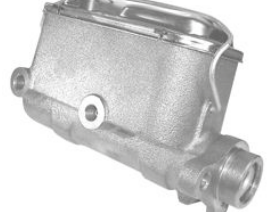

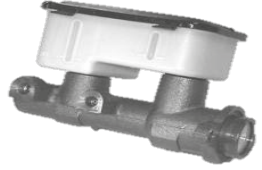
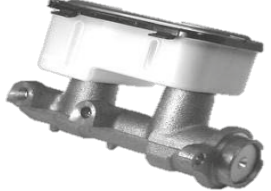
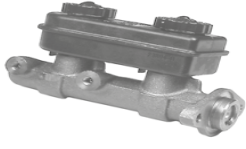
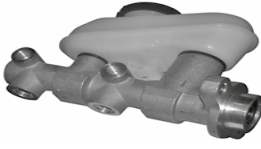



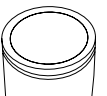

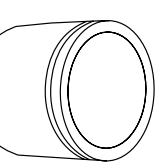



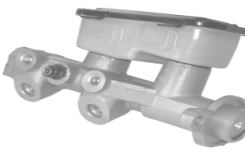
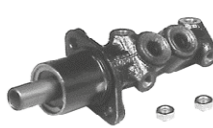

<p>No. Lusac: 96415</p> <p>Producto: CILINDRO MAESTRO</p> 		<p>No. Lusac: 98895</p> <p>Producto: CILINDRO MAESTRO</p> 		<p>No. Lusac: 98896</p> <p>Producto: CILINDRO MAESTRO</p> 			
DIAMETRO	19.0 mm 3/4"	DIAMETRO	28.5 mm 1-1/8"	DIAMETRO	28.5 mm 1-1/8"		
<p>VOLKSWAGEN</p> <p>SEDAN 92-04</p>		<p>DODGE</p> <p>RAM CHARGER 4X2 95-96 W250 4X4 LARGO 86-88</p> <p>RAM VAN 1500 95-95 W150 4X4 85-87</p> <p>RAM WAGON 1500 95-95 D150 83-93</p> <p>B350 INCLUYE MICROBUS 88-90 D350 81-87</p> <p>D250 86-93</p> <p>RAM CHARGER 4X2 86-93</p>		<p>DODGE</p> <p>W250 4X4 86-93</p>			
<p>No. Lusac: 98953</p> <p>Producto: CILINDRO MAESTRO</p> 		<p>No. Lusac: 104466</p> <p>Producto: CILINDRO MAESTRO</p> 		<p>No. Lusac: 104516</p> <p>Producto: CILINDRO MAESTRO</p> 			
DIAMETRO	33.3 mm 1-5/16"	DIAMETRO	25.4 & 36.0mm	DIAMETRO	28.5 & 40.0 mm		
<p>CHEVROLET</p> <p>P30 PANEL CON BARRA DE 1 5/16 DE DIAMETRO 87.08 88.02 C3500 89-89 C30 84-86</p>		<p>CHEVROLET</p> <p>C1500 88-91</p>		<p>CHEVROLET JEEP</p> <p>C15 82-86 WAGONEER 85-86</p> <p>C20 79-86</p>			
<p>No. Lusac: 108134</p> <p>Producto: CILINDRO MAESTRO</p> 		<p>No. Lusac: 108151</p> <p>Producto: CILINDRO MAESTRO</p> 		<p>No. Lusac: 108168</p> <p>Producto: CILINDRO MAESTRO</p> 			
DIAMETRO	21.0 mm	DIAMETRO	20.0 mm	DIAMETRO	24.0 mm		
<p>CHRYSLER</p> <p>PHANTOM 87-89 SHADOW 89-94</p> <p>NEW YORKER 85-89 SERIE 600K 84-85</p> <p>LE BARON K 83-87</p>		<p>FORD</p> <p>TOPAZ 94-94 93-94 92-93 TOPAZ 91-92 90-91 89-90 88-89 84-88</p> <p>GHIA 91-94</p>		<p>CHRYSLER</p> <p>GRAND VOYAGER S/ABS 95-95 NEW YORKER 90-94</p> <p>VOYAGER 95-95 PHANTOM 90-94</p> <p>TOWN & COUNTRY C/ABS 93-95 DODGE</p> <p>LE BARON 92-95 SPIRIT RT 91-92</p> <p>IMPERIAL C/ABS 91-91</p>			

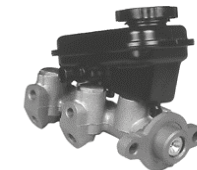

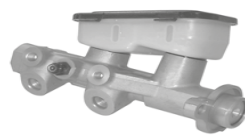

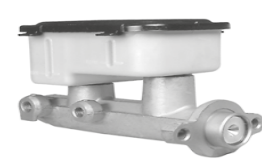





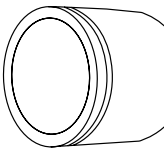

Fotografías de producto y especificaciones

No. Lusac: 108700 Producto: CILINDRO MAESTRO 		No. Lusac: 110983 Producto: CILINDRO MAESTRO 		No. Lusac: 112590 Producto: CILINDRO MAESTRO 	
DIAMETRO	24.0 mm	DIAMETRO	20.6 mm 13/16"	DIAMETRO	22.2 mm 7/8"
CHEVROLET CELEBRITY VAGONETA 85-86		VOLKSWAGEN JETTA A3 CL, A3 GL 97-98 JETTA A2 1.8 4 L 88-88		FORD TAURUS 88-89	
No. Lusac: 112591 Producto: CILINDRO MAESTRO 		No. Lusac: 114079 Producto: CILINDRO MAESTRO 		No. Lusac: 114190 Producto: CILINDRO MAESTRO 	
DIAMETRO	22.2 mm 7/8"	DIAMETRO	28.5 mm 1-1/8"	DIAMETRO	22.2 mm 7/8"
FORD TAURUS VAGONETA 88-89		FORD F250 92-93 F200 87-87 F200 2* 88-91		BUICK CHEVROLET CENTURY 87-89 CAVALIER 3.1 6 V 90-91	
No. Lusac: 114192 Producto: CILINDRO MAESTRO 		No. Lusac: 114195 Producto: CILINDRO MAESTRO 		No. Lusac: 116403 Producto: CILINDRO MAESTRO 	
DIAMETRO	24.0 mm	DIAMETRO	24.0 mm	DIAMETRO	22.2 mm 7/8"
BUICK OLDSMOBILE CENTURY 90-91 EUROSPOORT 91-91 CHEVROLET CUTLASS 87-91 CELEBRITY 87-89		BUICK OLDSMOBILE CENTURY 92-93 EUROSPOORT 92-93 CUTLASS 92-93		BUICK CHEVROLET CENTURY 83-86 CITATION 82-85	
No. Lusac: 120369 Producto: CILINDRO MAESTRO 		No. Lusac: 120590 Producto: CILINDRO MAESTRO 		No. Lusac: 120794 Producto: CILINDRO MAESTRO 	
DIAMETRO	26.9 mm 1-1/16"	DIAMETRO	31.7 mm 1-1/4"	DIAMETRO	23.8 mm 15/16"
FORD F150 C/ABS S/C DE VELOCIDAD 97-99 E150 ECONLINE WAGON S/C DE VELOCIDAD 95-96 E150 ECONLINE VAN 95-96 F150 6 V 94-99 F250 92-92		CHEVROLET MICROBUS 92-93 C3500 91-94		FORD TAURUS 90-90 THUNDERBIRD 89-89	







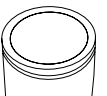

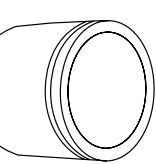
<p>No. Lusac: 122572 Producto: CILINDRO MAESTRO</p> 		<p>No. Lusac: 390004 Producto: CILINDRO MAESTRO</p> 		<p>No. Lusac: 390006 Producto: CILINDRO MAESTRO</p> 	
DIAMETRO	25.4 mm 1"	DIAMETRO	13/16"	DIAMETRO	3/4"
<p>FORD COUGAR S/ABS 95-95 THUNDERBIRD SUPERCARGADO 94-94 COUGAR 90-94 THUNDERBIRD SUPERCARGADO 90-92</p>		<p>MERCURY SABLE VAGONETA 94-95</p>		<p>NISSAN SENTRA 1.6 4 L C/CILINDRO TOKICO 92-92</p>	
<p>NISSAN TSUBAME 93-04 TSURU III GS C/CILINDRO NABCO 93-09 11-13</p>		<p>No. Lusac: 390007 Producto: CILINDRO MAESTRO</p> 		<p>No. Lusac: 390024 Producto: CILINDRO MAESTRO</p> 	
DIAMETRO	3/4"	DIAMETRO	1"	DIAMETRO	1"
<p>NISSAN MAXIMA SE C/ABS 07-08 ALTIMA S, SL, SE SEDAN C/ABS 02-07</p>		<p>FORD GRAND MARQUIS C/ABS 92-94</p> <p>MERCURY SABLE VAGONETA 94-95</p> <p>LINCOLN TOWN CAR C/ABS 92-94 91-94</p>		<p>NISSAN 300ZX 96-96 300ZX INCLUYE CONVERTIBLE 93-95</p> <p>300ZX 91-92</p>	
<p>No. Lusac: 390044 Producto: CILINDRO MAESTRO</p> 		<p>No. Lusac: 390049 Producto: CILINDRO MAESTRO</p> 		<p>No. Lusac: 390056 Producto: CILINDRO MAESTRO</p> 	
DIAMETRO	23.8 mm 15/16"	DIAMETRO	1"	DIAMETRO	1"
<p>HONDA DEL SOL 95-97 CIVIC C/ABS 92-95</p>		<p>MERCURY SABLE S/ABS 94-95</p>		<p>CHEVROLET TRACKER S/ABS 98-99</p>	



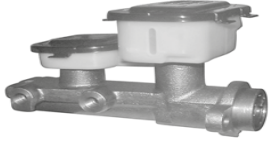

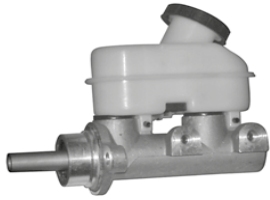
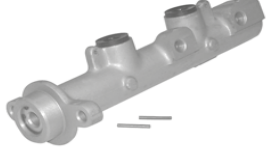
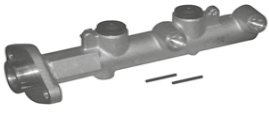

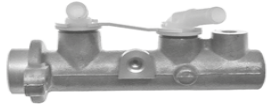

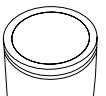

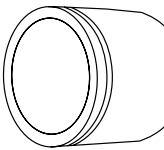



Fotografías de producto y especificaciones

No. Lusac: 390060 Producto: CILINDRO MAESTRO 		No. Lusac: 390063 Producto: CILINDRO MAESTRO 		No. Lusac: 390071 Producto: CILINDRO MAESTRO 	
DIAMETRO	13/16"	DIAMETRO	28.6 y 40.0 mm	DIAMETRO	1"
SEAT IBIZA 05-09 GOLF A3 CL, A3 GL 1.8 4L 95-96 TOLEDO TURBO 02-04 GOLF A3 GTI 93-94 TOLEDO 01-06 GOLF A2 GTI 91-92 VOLKSWAGEN CABRIO A3 2 4 L OHC S/ABS 96-96 JETTA A2 88-92		CHEVROLET ASTRO 90-94		GMC SAFARI 90-94	
				JEEP WRANGLER C/ABS 93-95 GRAND CHEROKEE C/ABS 93-94	
No. Lusac: 390073 Producto: CILINDRO MAESTRO 		No. Lusac: 390096 Producto: CILINDRO MAESTRO 		No. Lusac: 390110 Producto: CILINDRO MAESTRO 	
DIAMETRO	15/16"	DIAMETRO	1-1/16"	DIAMETRO	15/16"
CHEVROLET CORVETTE 92-94		DODGE VIPER 93-93		FORD AEROSTAR 92-95	
				CHRYSLER NEW YORKER LH S/ABS 95-95 CONCORDE S/ABS S/C DE TRACCIÓN 93-97	
No. Lusac: 390111 Producto: CILINDRO MAESTRO 		No. Lusac: 390115 Producto: CILINDRO MAESTRO 		No. Lusac: 390116 Producto: CILINDRO MAESTRO 	
DIAMETRO	15/16"	DIAMETRO	1"	DIAMETRO	1"
CHRYSLER NEW YORKER LH C/ABS 95-95 NEW YORKER LHS C/ABS 94-96 CONCORDE C/ABS C/C DE TRACCIÓN 93-97		DODGE INTREPID C/ABS 94-97		MERCURY VILLAGER C/ABS 93-00	
				NISSAN QUEST C/ABS 97-02	
				NISSAN QUEST S/ABS 97-98	







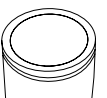

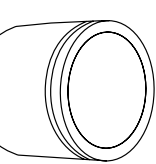



No. Lusac: 390118 Producto: CILINDRO MAESTRO 		No. Lusac: 390121 Producto: CILINDRO MAESTRO 		No. Lusac: 390126 Producto: CILINDRO MAESTRO 	
DIAMETRO	1"	DIAMETRO	15/16"	DIAMETRO	1-1/16"
NISSAN PICKUP NISSAN 93-97 PICKUP NISSAN 3 C/CILINDRO TOKICO DESDE 92-92		NISSAN MAXIMA 3 6 V S/ABS 92-93 MAXIMA S/ABS 91-91		FORD THUNDERBIRD C/ABS 96-96 COUGAR C/ABS 95-95	
No. Lusac: 390139 Producto: CILINDRO MAESTRO 		No. Lusac: 390140 Producto: CILINDRO MAESTRO 		No. Lusac: 390141 Producto: CILINDRO MAESTRO 	
DIAMETRO	15/16"	DIAMETRO	15/16"	DIAMETRO	1"
NISSAN ALTIMA S/ABS 96-00		NISSAN ALTIMA SE S/ABS C/CILINDRO TOKICO 96-99 ALTIMA S/ABS 00-00		NISSAN ALTIMA C/ABS 96-00	
No. Lusac: 390156 Producto: CILINDRO MAESTRO 		No. Lusac: 390161 Producto: CILINDRO MAESTRO 		No. Lusac: 390167 Producto: CILINDRO MAESTRO 	
DIAMETRO	23.8 mm 15/16"	DIAMETRO	23.8 mm 15/16"	DIAMETRO	23.8 mm 15/16"
MITSUBISHI MONTERO SPORT 93-03 MONTERO S/ABS 92-00		CHEVROLET LUV 2.3 97-05 AMIGO 93-93 ISUZU PICKUP ISUZU 93-95		VOLKSWAGEN JETTA AUTOMÁTICA 95-95 PASSAT 95-95 JETTA MANUAL 94-94 GOLF 93-95 JETTA 93-93	









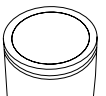

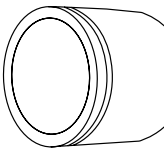



Fotografías de producto y especificaciones

No. Lusac: 390170 Producto: CILINDRO MAESTRO 		No. Lusac: 390174 Producto: CILINDRO MAESTRO 		No. Lusac: 390175 Producto: CILINDRO MAESTRO 	
DIAMETRO	1"	DIAMETRO	7/8"	DIAMETRO	24mm
INFINITI Q45 94-96		CHEVROLET CAVALIER 3.1 6 V 92-94		BUICK REGAL 94-96	
				CHEVROLET LUMINA C/ABS 97-01	
No. Lusac: 390176 Producto: CILINDRO MAESTRO 		No. Lusac: 390178 Producto: CILINDRO MAESTRO 		No. Lusac: 390179 Producto: CILINDRO MAESTRO 	
DIAMETRO	24mm	DIAMETRO	24mm	DIAMETRO	24mm
CHEVROLET LUMINA S/ABS 97-01		CHEVROLET LUMINA 95-96		BUICK CENTURY 94-96	
PONTIAC GRAND PRIX GT, GTP, SE 97-98		CHEVROLET SILHOUETTE 3.1 6 V 92-92		OLDSMOBILE CUTLASS 94-96	
		OLDSMOBILE SILHOUETTE 3.8 6 V C/ABS 94-95			
No. Lusac: 390182 Producto: CILINDRO MAESTRO 		No. Lusac: 390183 Producto: CILINDRO MAESTRO 		No. Lusac: 390184 Producto: CILINDRO MAESTRO 	
DIAMETRO	1-1/8"	DIAMETRO	1-1/8"	DIAMETRO	1-1/8"
FORD E150 ECONLINE WAGON 97-97		FORD F150 6 V C/C DE VELOCIDAD 97-99		FORD P350 MICROBUS C/C DE VELOCIDAD MICROBUS 96-96	
E350 ECONOLINE CLUB WAGON C/ABS S/C DE VELOCIDAD 95-96		F150 C/C DE VELOCIDAD 94-95			
E150 ECONOLINE VAN 97-97		F150 C/C DE VELOCIDAD 97-99		F250 C/C DE VELOCIDAD 95-95	
		E150 ECONOLINE WAGON 6 V C/C DE VELOCIDAD 95-96			







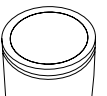

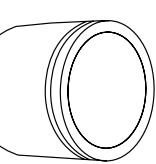

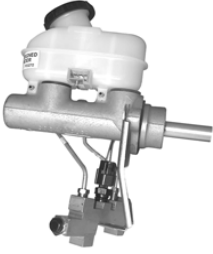

<p>No. Lusac: 390185 Producto: CILINDRO MAESTRO</p> 		<p>No. Lusac: 390186 Producto: CILINDRO MAESTRO</p> 		<p>No. Lusac: 390188 Producto: CILINDRO MAESTRO</p> 	
DIAMETRO	1-1/16"	DIAMETRO	1"	DIAMETRO	24mm
<p>FORD MUSTANG GT 94-95</p>		<p>OLDSMOBILE EIGHTY EIGHT 94-95</p>		<p>PONTIAC BONNEVILLE 94-95</p>	
<p>No. Lusac: 390190 Producto: CILINDRO MAESTRO</p> 		<p>No. Lusac: 390204 Producto: CILINDRO MAESTRO</p> 		<p>No. Lusac: 390205 Producto: CILINDRO MAESTRO</p> 	
DIAMETRO	1-1/4"	DIAMETRO	21mm	DIAMETRO	21mm
<p>DODGE RAM 3500 4X2 94-94 RAM 3500 4X4 94-94</p>		<p>CHRYSLER NEON R S/ABS 95-96</p>		<p>CHRYSLER NEON C/ABS 95-96</p>	
<p>No. Lusac: 390213 Producto: CILINDRO MAESTRO</p> 		<p>No. Lusac: 390214 Producto: CILINDRO MAESTRO</p> 		<p>No. Lusac: 390215 Producto: CILINDRO MAESTRO</p> 	
DIAMETRO	7/8"	DIAMETRO	1"	DIAMETRO	7/8"
<p>CHRYSLER NEON S/ABS 97-99 97-97</p>		<p>CHEVROLET CAMARO 95-97</p>		<p>PONTIAC FIREBIRD TRANS AM 94-97</p>	
				<p>CHRYSLER NEON C/ABS 97-99</p>	









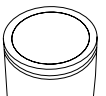

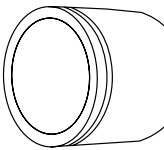

Fotografías de producto y especificaciones

No. Lusac: 390216 Producto: CILINDRO MAESTRO 		No. Lusac: 390217 Producto: CILINDRO MAESTRO 		No. Lusac: 390224 Producto: CILINDRO MAESTRO 	
DIAMETRO	1-1/16"	DIAMETRO	23.8 mm 15/16"	DIAMETRO	15/16"
FORD AEROSTAR 91-91		FORD MUSTANG COBRA 94-95 GHIA 94-94		FORD ESCORT ATM 94-96 ESCORT VAGONETA 94-96 ESCORT GT ATM 94-95	
No. Lusac: 390225 Producto: CILINDRO MAESTRO 		No. Lusac: 390226 Producto: CILINDRO MAESTRO 		No. Lusac: 390231 Producto: CILINDRO MAESTRO 	
DIAMETRO	15/16"	DIAMETRO	1"	DIAMETRO	15/16"
FORD ESCORT MANUAL 94-96 ESCORT VAGONETA 94-96 ESCORT GT MANUAL 94-95		FORD CONTOUR S/ABS 96-96		MERCURY MYSTIQUE S/ABS 95-96	
				NISSAN 240SX C/ABS 98-98 93-93	
No. Lusac: 390233 Producto: CILINDRO MAESTRO 		No. Lusac: 390234 Producto: CILINDRO MAESTRO 		No. Lusac: 390235 Producto: CILINDRO MAESTRO 	
DIAMETRO	15/16"	DIAMETRO	15/16"	DIAMETRO	15/16"
INFINITI I30 98-99		NISSAN MAXIMA S/ABS C/CILINDRO NABCO 95-99 SENTRA SE-R 2.5 4 L S/ABS 02-04 SENTRA SE-R 2.5 4 L S/ABS 08-09 SENTRA SE, XE, GXE S/ABS 06-06 SENTRA SE, XE, GXE S/ABS 01-01 SENTRA SE-R 2.5 4 L S/ABS 05-06 SENTRA SE, XE, GXE S/ABS 05-06 04-05 03-04		NISSAN MAXIMA S/ABS C/CILINDRO TOKICO 95-01	

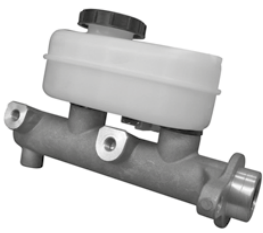

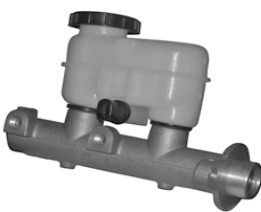



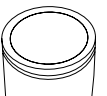

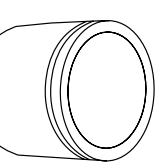

<p>No. Lusac: 390236 Producto: CILINDRO MAESTRO</p> 		<p>No. Lusac: 390239 Producto: CILINDRO MAESTRO</p> 		<p>No. Lusac: 390244 Producto: CILINDRO MAESTRO</p> 	
DIAMETRO	26.9 mm 1-1/16"	DIAMETRO	15/16"	DIAMETRO	1" & 13/16"
<p>TOYOTA 4RUNNER 94-95 PICKUP TOYOTA 94-94</p>		<p>BMW 325i 95-97</p>		<p>BMW M3 95-99</p>	
<p>No. Lusac: 390245 Producto: CILINDRO MAESTRO</p> 		<p>No. Lusac: 390248 Producto: CILINDRO MAESTRO</p> 		<p>No. Lusac: 390251 Producto: CILINDRO MAESTRO</p> 	
DIAMETRO	1"	DIAMETRO	1-1/16"	DIAMETRO	7/8"
<p>FORD GRAND MARQUIS C/ABS 95-95</p>		<p>FORD WINDSTAR S/C DE TRACCIÓN 95-97</p>		<p>CHRYSLER SEBRING CONVERTIBLE S/ABS 98-00 SEBRING RT S/ABS 97-97 STRATUS S/ABS 97-02 STRATUS 96-00 STRATUS S/ABS 96-97</p>	
<p>LINCOLN TOWN CAR C/ABS 95-96</p>				<p>SEBRING CONVERTIBLE S/ABS 96-96 STRATUS S/ABS 96-96 CIRRUS S/ABS 96-00 STRATUS 95-96</p>	
<p>No. Lusac: 390254 Producto: CILINDRO MAESTRO</p> 		<p>No. Lusac: 390255 Producto: CILINDRO MAESTRO</p> 		<p>No. Lusac: 390256 Producto: CILINDRO MAESTRO</p> 	
DIAMETRO	7/8"	DIAMETRO	15/16"	DIAMETRO	1"
<p>CHRYSLER SEBRING RT C/ABS 97-97 STRATUS C/ABS 97-97 CIRRUS C/ABS 96-97</p>		<p>CHEVROLET CORVETTE 95-96</p>		<p>FORD GRAND MARQUIS S/ABS 95-96</p>	
<p>LINCOLN TOWN CAR S/ABS 95-96</p>				<p>LINCOLN TOWN CAR S/ABS 95-96</p>	



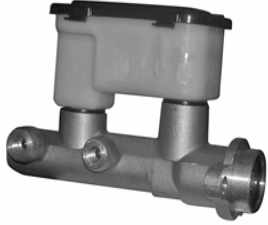





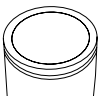

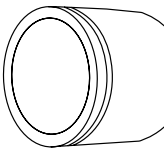

Fotografías de producto y especificaciones

No. Lusac: 390257		No. Lusac: 390258		No. Lusac: 390259					
Producto: CILINDRO MAESTRO		Producto: CILINDRO MAESTRO		Producto: CILINDRO MAESTRO					
									
DIAMETRO	1-1/4"	DIAMETRO	1-1/4"	DIAMETRO	40mm & 1/8"				
CHEVROLET C2500 CLASSIC K2500 4X4 99-99 RAM 1500 4X2 97-97 C2500 SILVERADO CLASSIC 99-99 RAM 1500 4X4 97-97 C1500 95-99 RAM 2500 94-97 C2500 CHEYENNE 95-99 C2500 95-99 C2500 CLASSIC 4X4 00-00 SIERRA K2500 CLASSIC 99-00		DODGE RAM 3500 4X2 95-97 RAM 4000 95-97 RAM 3500 4X4 95-97		CADILLAC ESCALADE 99-00 TAHOE 5.7 8 V 00-00					
DODGE RAM 2500 98-99				CHEVROLET C2500 CLASSIC K2500 4X4 99-99 RAM 2500 97-97 C2500 SILVERADO CLASSIC 99-99 RAM 1500 4X2 95-96 C1500 95-99 RAM 1500 4X4 95-96 C2500 95-99 RAM 2500 95-96 C2500 CHEYENNE 94-99 RAM 2500 INCLUYE CLUB CAB 94 C1500 94-94 SONORA 01-02 C2500 CLASSIC 4X4 00-00 SONORA 2000 SONORA 2000 SUBURBAN 1500 2000				DODGE SIERRA 2500 99-00 SIERRA K2500 CLASSIC 99-00	
GMC SIERRA 2500 99-00				GMC SIERRA 2500 99-00 SIERRA K2500 CLASSIC 99-00					
No. Lusac: 390267		No. Lusac: 390268		No. Lusac: 390269					
Producto: CILINDRO MAESTRO		Producto: CILINDRO MAESTRO		Producto: CILINDRO MAESTRO					
									
DIAMETRO	1"	DIAMETRO	1-1/16"	DIAMETRO	1-1/16"				
CADILLAC SEVILLE STS 98-01 SEVILLE 02-02 DEVILLE 95-99 ELDORADO 95-02 SEVILLE 94-97 SEVILLE STS 03-04		FORD RANGER C/ABS 96-97 EXPLORER C/C DE VELOCIDAD 95-97		FORD RANGER 96-97 EXPLORER S/C DE VELOCIDAD 95-97					
PONTIAC BONNEVILLE 96-99									



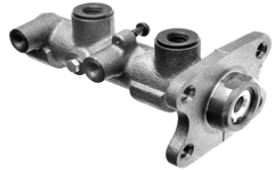
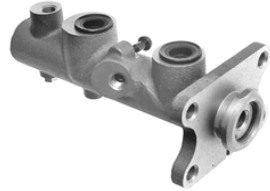



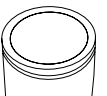

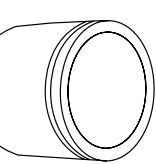





<p>No. Lusac: 390271 Producto: CILINDRO MAESTRO</p> 		<p>No. Lusac: 390275 Producto: CILINDRO MAESTRO</p> 		<p>No. Lusac: 390277 Producto: CILINDRO MAESTRO</p> 	
DIAMETRO	7/8"	DIAMETRO	15/16"	DIAMETRO	7/8"
<p>SEAT</p> <p>IBIZA 01-02 GOLF A3 GTI 95-96</p>		<p>CHRYSLER DODGE</p> <p>VOYAGER 97-00 CARAVAN FLEX FUEL S/C DE TRACCIÓN 98-00</p>		<p>CHEVROLET PONTIAC</p> <p>CAVALIER Z24 2.4 L 96-96 SUNFIRE 97-99</p>	
<p>VOLKSWAGEN</p> <p>JETTA A3 CL, A3 GL 1.8 4 L 95</p> <p>JETTA A3 GLS, A3 EUROPA 2 S/ABS 93-93</p> <p>PASSAT 2.8 6 VR 96-97 JETTA A3 VR6 2.8 6 VR 95-98</p> <p>PASSAT VAGONETA 96-97 CABRIO A4 2.4 L OHC 02</p> <p>GOLF A3 GTI VR6 95-98</p> <p>JETTA A3 VR6 2.8 6 VR 95-98</p>		<p>GRAND VOYAGER C/ABS S/C DE TRACCIÓN 96-96 CARAVAN GASOLINA S/C DE TRACCIÓN 97-00</p> <p>TOWN & COUNTRY S/C DE TRACCIÓN 96-96 GRAND CARAVAN FWD S/C DE TRACCIÓN 97-00</p> <p>VOYAGER 96-96</p>		<p>CAVALIER 95-99</p> <p>CAVALIER 2.2 4 L 95-99</p>	
<p>No. Lusac: 390278 Producto: CILINDRO MAESTRO</p> 		<p>No. Lusac: 390279 Producto: CILINDRO MAESTRO</p> 		<p>No. Lusac: 390285 Producto: CILINDRO MAESTRO</p> 	
DIAMETRO	40mm	DIAMETRO	1-1/4"	DIAMETRO	1"
<p>CHEVROLET</p> <p>C3500HD 96-99 P30 PANEL 01-01</p> <p>SILVERADO 3500 01-02</p>		<p>CHEVROLET</p> <p>C3500 SILVERADO CLASSIC 99-99 C3500 95-99 95-95</p> <p>C3500HD 96-99</p> <p>P30 PANEL 96-00</p>		<p>TOYOTA</p> <p>TACOMA S/ABS 95-01</p>	
<p>No. Lusac: 390289 Producto: CILINDRO MAESTRO</p> 		<p>No. Lusac: 390298 Producto: CILINDRO MAESTRO</p> 		<p>No. Lusac: 390299 Producto: CILINDRO MAESTRO</p> 	
DIAMETRO	25.4 mm 1"	DIAMETRO	1"	DIAMETRO	1"
<p>TOYOTA</p> <p>TACOMA 4X4 C/ABS 95-01</p>		<p>MERCURY</p> <p>SABLE 3.6 V 96-96</p>		<p>FORD LINCOLN</p> <p>GRAND MARQUIS C/ABS 96-96 TOWN CAR C/ABS S/C DE TRACCIÓN 97-97</p>	







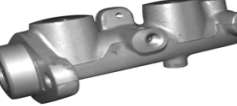

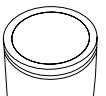

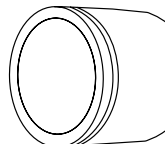

Fotografías de producto y especificaciones

No. Lusac: 390303		No. Lusac: 390306		No. Lusac: 390308	
Producto: CILINDRO MAESTRO		Producto: CILINDRO MAESTRO		Producto: CILINDRO MAESTRO	
					
DIAMETRO	1"	DIAMETRO	25.4 mm 1"	DIAMETRO	1"
JEEP CHEROKEE SPORT 98-99 CHEROKEE SPORT 4X2 00-01 GRAND CHEROKEE 95-98 CHEROKEE 95-97		LINCOLN CONTINENTAL C/ABS 97-97		FORD MUSTANG GT 96-97	
No. Lusac: 390309		No. Lusac: 390313		No. Lusac: 390314	
Producto: CILINDRO MAESTRO		Producto: CILINDRO MAESTRO		Producto: CILINDRO MAESTRO	
					
DIAMETRO	1"	DIAMETRO	1-1/16"	DIAMETRO	1-1/16"
FORD MUSTANG COBRA 4.6 8 V 97-97		FORD EXPLORER S/C DE VELOCIDAD 97-97 95-96		FORD EXPLORER C/C DE VELOCIDAD 97-97 95-96	
No. Lusac: 390317		No. Lusac: 390318		No. Lusac: 390319	
Producto: CILINDRO MAESTRO		Producto: CILINDRO MAESTRO		Producto: CILINDRO MAESTRO	
					
DIAMETRO	13/16"	DIAMETRO	7/8"	DIAMETRO	7/8"
NISSAN SENTRA GST, GSX S/ABS96-00		NISSAN LUCINO GSE S/ABS 96-00 TSURU GSR 2000 95-96 LUCINO GSR S/ABS 96-00		NISSAN LUCINO GSE C/ABS 96-00 SENTRA GST, GSX C/ABS 96-00 LUCINO GSR C/ABS 96-00	
No. Lusac: 390320		No. Lusac: 390321		No. Lusac: 390323	
Producto: CILINDRO MAESTRO		Producto: CILINDRO MAESTRO		Producto: CILINDRO MAESTRO	
					
DIAMETRO	36mm & 24mm	DIAMETRO	1-1/4"	DIAMETRO	7/8"
CHEVROLET BLAZER 4X2 96-97 S-10 96-97 BLAZER 4X4 96-97		CHEVROLET GMC ASTRO 96-03 SAFARI 96-03		HONDA CIVIC EX, SI SEDAN C/ABS 99-99 CIVIC EX, SI SEDAN C/ABS 01-01 00-01 CIVIC EX SEDAN C/ABS 97-98	

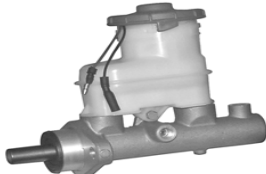





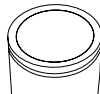

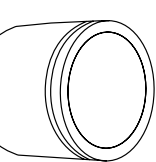



<p>No. Lusac: 390325 Producto: CILINDRO MAESTRO</p> 		<p>No. Lusac: 390326 Producto: CILINDRO MAESTRO</p> 		<p>No. Lusac: 390328 Producto: CILINDRO MAESTRO</p> 	
DIAMETRO	50.8 mm 2"	DIAMETRO	15/16"	DIAMETRO	13/16"
<p>CHEVROLET C70 88-89 90-00</p>		<p>CHEVROLET TRACKER S/ABS 98-99</p>		<p>HONDA CIVIC SEDAN S/ABS 97-01 CIVIC CX, DX SEDAN 96-96 CIVIC CX, DX COUPE 96-96</p>	
<p>No. Lusac: 390329 Producto: CILINDRO MAESTRO</p> 		<p>No. Lusac: 390331 Producto: CILINDRO MAESTRO</p> 		<p>No. Lusac: 390335 Producto: CILINDRO MAESTRO</p> 	
DIAMETRO	1-1/16"	DIAMETRO	22.2 mm 7/8"	DIAMETRO	15/16"
<p>FORD WINDSTAR C/C DE TRACCIÓN 96-98</p>		<p>HONDA CIVIC 1.5 96-98 CIVIC LX 1.6 96-98 CIVIC GX 1.6 96-98</p>		<p>CHEVROLET TRACKER C/ABS 98-99</p>	
<p>No. Lusac: 390336 Producto: CILINDRO MAESTRO</p> 		<p>No. Lusac: 390337 Producto: CILINDRO MAESTRO</p> 		<p>No. Lusac: 390338 Producto: CILINDRO MAESTRO</p> 	
DIAMETRO	1-1/4"	DIAMETRO	1-1/4"	DIAMETRO	1-1/4"
<p>FORD EXPEDITION INLCUYE EDDIE BAUER 97-99 EXPEDITION INLCUYE EDDIE BAUER 4X2 97-01 LOBO 03-04 LOBO 01-02 F150 6 V 00-03</p>		<p>FORD F350 SUPER DUTY, XL, XLT 5.4 8 V 99-99 F350 SUPER DUTY, XL, XLT 5.4 8 V 99-00 F350 SUPER DUTY, XL, XLT 99-00 F250 XL 98-99 F350 98-98 F250 4X4 97-97 P350 MICROBUS 97-97 EXPEDITION INLCUYE EDDIE BAUER 4X2 97-02 EXPEDITION INLCUYE EDDIE BAUER 4X4 97-02 F250 96-96 F350 SUPER DUTY, XL, XLT 06-07 F350 SUPER DUTY, XL, XLT 05-06 04-05 F350 SUPER DUTY, XL, XLT 5.4 8 V OHC 04-04</p>		<p>FORD EXPEDITION XLT, EDDIE BAUER 4X2 03-06 F350 SUPER DUTY, XL, XLT 03-04 F350 SUPER DUTY, XL, XLT 5.4 8 V 02-03 LOBO 01-04 F350 SUPER DUTY, XL, XLT 5.4 8 V OHC 01-02 F350 SUPER DUTY, XL, XLT 01-02 F150 00-01 F350 SUPER DUTY, XL, XLT 5.4 8 V 00-01 F350 SUPER DUTY, XL, XLT 00-01 LINCOLN NAVIGATOR 4X2 99-02 NAVIGATOR 4X4 98-02</p>	
<p>LINCOLN NAVIGATOR 4X2 99-02 NAVIGATOR 4X4 98-02</p>		<p>LINCOLN NAVIGATOR 4X2 99-02 NAVIGATOR 4X4 98-02</p>		<p>F250 01-02 F250 SUPER DUTY 01-02</p>	





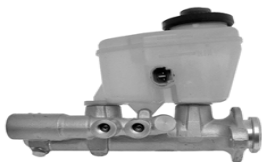



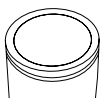

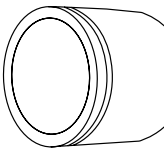

Fotografías de producto y especificaciones

No. Lusac: 390339 Producto: CILINDRO MAESTRO 		No. Lusac: 390342 Producto: CILINDRO MAESTRO 		No. Lusac: 390343 Producto: CILINDRO MAESTRO 	
DIAMETRO	1-1/4"	DIAMETRO	1"	DIAMETRO	1"
FORD F250 XL 4.6 8 V OHC S/C DE VELOCIDAD 98-99 F350 S/C DE VELOCIDAD 98-98 F250 XL S/C DE VELOCIDAD 97-99 F250 S/C DE VELOCIDAD 97-97 P350 MICROBUS S/C DE VELOCIDAD MICROBUS 97-97		NISSAN PATHFINDER 4X4 96-01		NISSAN PICKUP NISSAN D-21 99-01	
No. Lusac: 390344 Producto: CILINDRO MAESTRO 		No. Lusac: 390347 Producto: CILINDRO MAESTRO 		No. Lusac: 390363 Producto: CILINDRO MAESTRO 	
DIAMETRO	1"	DIAMETRO	1"	DIAMETRO	1-1/8"
NISSAN PICKUP NISSAN 96-97		NISSAN PATHFINDER DOBLE CABINA 97-00 PATHFINDER 4X2 96-01		CHEVROLET GMC EXPRESS 2500 98-99 SAVANA 1500 96-02 EXPRESS 1500 98-02 96-96 SAVANA 2500 EXT 96-02 EXPRESS 2500 EXT 96-96	
No. Lusac: 390364 Producto: CILINDRO MAESTRO 		No. Lusac: 390367 Producto: CILINDRO MAESTRO 		No. Lusac: 390368 Producto: CILINDRO MAESTRO 	
DIAMETRO	1-1/4"	DIAMETRO	25.4 mm 1"	DIAMETRO	25.4 mm 1"
CHEVROLET EXPRESS 3500 CARGO VAN 97-03 EXPRESS 3500 VAN 03-03 EXPRESS 2500 EXT 96-96 EXPRESS 3500 96-96 EXPRESS 3500 VAN 04-06 GMC SAVANA 2500 EXT 96-02		TOYOTA 4RUNNER C/ABS 96-01		TOYOTA 4RUNNER S/ABS 96-01	



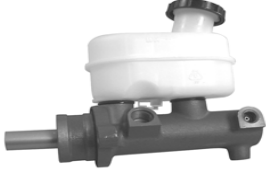

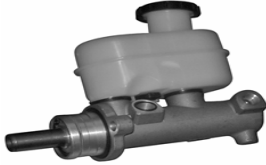

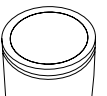

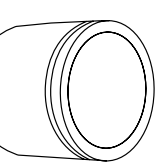

<p>No. Lusac: 390370</p> <p>Producto: CILINDRO MAESTRO</p> 		<p>No. Lusac: 390371</p> <p>Producto: CILINDRO MAESTRO</p> 		<p>No. Lusac: 390377</p> <p>Producto: CILINDRO MAESTRO</p> 	
DIAMETRO	1"	DIAMETRO	1"	DIAMETRO	15/16"
<p>MERCURY</p> <p>SABLE 3.6 V 97-99 SABLE VAGONETA 96-97</p> <p>SABLE S/C DE TRACCIÓN 05-05 00-03</p>		<p>CHEVROLET</p> <p>VENTURE APV C/ABS 97-99</p>		<p>CHRYSLER</p> <p>GRAND VOYAGER C/C DE TRACCIÓN 97-00 VOYAGER C/C DE TRACCIÓN 97-00 TOWN & COUNTRY C/C DE TRACCIÓN 96-00</p> <p>DODGE</p> <p>CARAVAN FLEX FUEL C/C DE TRACCIÓN 98-00</p> <p>CARAVAN GASOLINA C/C DE TRACCIÓN 97-00 GRAND CARAVAN FWD C/C DE TRACCIÓN 97-00 RAM 4000 C/C DE TRACCIÓN 05-06</p>	
<p>No. Lusac: 390378</p> <p>Producto: CILINDRO MAESTRO</p> 		<p>No. Lusac: 390386</p> <p>Producto: CILINDRO MAESTRO</p> 		<p>No. Lusac: 390389</p> <p>Producto: CILINDRO MAESTRO</p> 	
DIAMETRO	1"	DIAMETRO	1"	DIAMETRO	1-1/4"
<p>JEEP</p> <p>WRANGLER SAHARA 97-02 WRANGLER UNLIMITED RUBICON 05-06</p>		<p>CHEVROLET</p> <p>MALIBU LX, LS 3.1 6 V C/ABS 97-01</p> <p>PONTIAC</p> <p>GRAND AM 99-00</p>		<p>FORD</p> <p>E250 ECONOLINE VAN C/ABS 98-99 E350 ECONOLINE VAN S/C DE VELOCIDAD 98-98</p>	
<p>No. Lusac: 390392</p> <p>Producto: CILINDRO MAESTRO</p> 		<p>No. Lusac: 390393</p> <p>Producto: CILINDRO MAESTRO</p> 		<p>No. Lusac: 390394</p> <p>Producto: CILINDRO MAESTRO</p> 	
DIAMETRO	1-1/8"	DIAMETRO	1-1/8"	DIAMETRO	1-1/4"
<p>FORD</p> <p>E150 ECONLINE WAGON 97-99 E150 ECONOLINE VAN 97-98 01-01</p>		<p>FORD</p> <p>E150 ECONLINE WAGON C/C DE VELOCIDAD 97-99 E150 ECONOLINE VAN 97-01</p>		<p>FORD</p> <p>E150 ECONLINE WAGON 99-99 E150 ECONOLINE VAN 99-00 E250 ECONOLINE VAN 98-99</p> <p>E350 ECONOLINE VAN 98-98 E350 ECONOLINE CLUB WAGON C/C DE VELOCIDAD 95-98</p>	



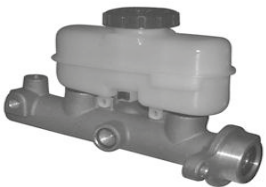

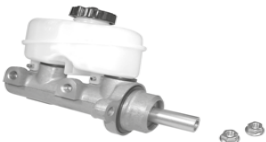



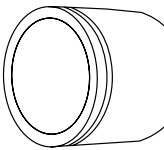

Fotografías de producto y especificaciones

No. Lusac: 390395 Producto: CILINDRO MAESTRO		No. Lusac: 390398 Producto: CILINDRO MAESTRO		No. Lusac: 390399 Producto: CILINDRO MAESTRO	
					
DIAMETRO	1"	DIAMETRO	1-1/16"	DIAMETRO	1-1/16"
FORD WINDSTAR S/C DE TRACCIÓN 97-98		FORD LINCOLN EXPLORER EDDIE BAUER 5 8 V 98-98 AVIATOR 03-05 EXPLORER SPORT 98-00 EXPLORER EDDIE BAUER EXCEPTO 06-08 RANGER 01-06 EXPLORER EDDIE BAUER 5 8 V 01-01 RANGER 01-01		FORD EXPLORER SPORT 99-00 EXPLORER EDDIE BAUER 4 8 6 V S/C DE VELOCIDAD 98-98 EXPLORER SPORT 4 8 6 V 98-98 EXPLORER EDDIE BAUER 98-02 RANGER S/C DE VELOCIDAD 98-00 EXPLORER SPORT 03-03 RANGER S/C DE VELOCIDAD 02-05	
MAZDA B2500 C/C DE VELOCIDAD 98-01		MAZDA B2300 01-10 B3000 01-08		MAZDA B2500 S/C DE VELOCIDAD 98-01 B3000 S/C DE VELOCIDAD 98-01 B2300 S/C DE VELOCIDAD HASTA 7/01 01-01	
No. Lusac: 390400 Producto: CILINDRO MAESTRO		No. Lusac: 390401 Producto: CILINDRO MAESTRO		No. Lusac: 390406 Producto: CILINDRO MAESTRO	
					
DIAMETRO	1-1/16"	DIAMETRO	1"	DIAMETRO	15/16"
FORD EXPLORER SPORT C/C DE VELOCIDAD 98-03 EXPLORER EDDIE BAUER C/C DE VELOCIDAD 98-02 RANGER 4X4 C/C DE VELOCIDAD 98-00 RANGER 4X4 S/C DE VELOCIDAD 98-00		MAZDA B3000 C/C DE VELOCIDAD 98-00		BUICK LACROSSE 05-09	
OLDSMOBILE SILHOUETTE 00-04		HONDA CIVIC EX SEDAN C/ABS 97-98		CHEVROLET VENTURE 05-05 IMPALA C/ABS 00-04 VENTURE APV 00-04	
PONTIAC GRAND PRIX GT, GTP, SE 99-99 99-99 99-00 MONTANA SV6 C/ABS 05-05 GRAND PRIX GT, GTP, SE 01-01 01-01 00-01 00-00					
No. Lusac: 390408 Producto: CILINDRO MAESTRO		No. Lusac: 390417 Producto: CILINDRO MAESTRO		No. Lusac: 390418 Producto: CILINDRO MAESTRO	
					
DIAMETRO	1-1/16"	DIAMETRO	15/16"	DIAMETRO	1"
DODGE DURANGO 98-98		HONDA ACCORD 2.3 4 L OHC S/ABS 98-02 ACCORD 3 6 V S/ABS 98-00		HONDA ACCORD 3 6 V C/ABS 98-02 ACCORD C/ABS 98-02	

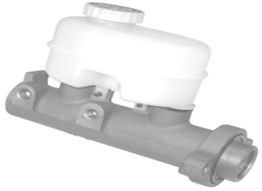

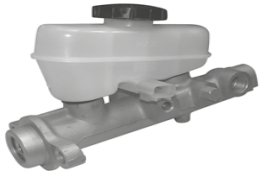
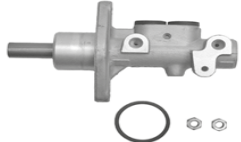
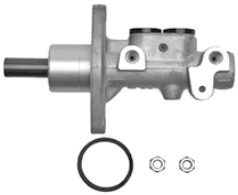

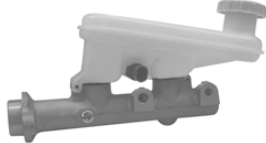

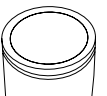

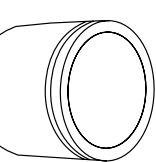



No. Lusac: 390419 Producto: CILINDRO MAESTRO		No. Lusac: 390425 Producto: CILINDRO MAESTRO		No. Lusac: 390426 Producto: CILINDRO MAESTRO	
					
DIAMETRO	1"	DIAMETRO	7/8"	DIAMETRO	1-1/4"
CADILLAC CATERA 97-01		CHRYSLER STRATUS C/ABS 98-02 SEBRING CONVERTIBLE C/ABS 98-00 CIRRUS C/ABS 98-00		DODGE RAM 4000 99-01 RAM 3500 4X2 00-02 RAM 2500 INCLUYE QUAD CAB INCLUYE QUAD CAB 98-99 RAM 3500 4X4 C/ABS 00-02 RAM 3500 98-99 RAM 1500 4X4 C/ABS 00-01 RAM 1500 4X4 98-01 RAM 2500 INCLUYE QUAD CAB INCLUYE QUAD CAB 00-00 RAM 1500 4X2 97-01 RAM 3500 HASTA 7/4/00 00-00 RAM 2500 INCLUYE QUAD CAB INCLUYE QUAD CAB 01-01 RAM 3500 01-01	
No. Lusac: 390427 Producto: CILINDRO MAESTRO		No. Lusac: 390430 Producto: CILINDRO MAESTRO		No. Lusac: 390432 Producto: CILINDRO MAESTRO	
					
DIAMETRO	1"	DIAMETRO	1"	DIAMETRO	7/8"
CHEVROLET BLAZER 4X4 98-99 JIMMY C/CILINDRO 99-00 S-10 98-99 OLDSMOBILE BLAZER 4X2 98-01 BRAVADA C/CILINDRO 98-01		FORD GRAND MARQUIS C/ABS 97-97		LINCOLN TOWN CAR C/ABS C/C DE TRACCIÓN 97-97	
VOLKSWAGEN GOLF A3 GTI C/ABS 95-99 JETTA A3 VR6 2.8 6 VR C/ABS 95-98 GOLF A3 GTI VR6 C/ABS 95-98					
No. Lusac: 390433 Producto: CILINDRO MAESTRO		No. Lusac: 390439 Producto: CILINDRO MAESTRO		No. Lusac: 390440 Producto: CILINDRO MAESTRO	
					
DIAMETRO	1"	DIAMETRO	23.8 mm 15/16"	DIAMETRO	15/16"
VOLKSWAGEN PASSAT VAGONETA 96-97		AUDI A4 AVANT 98-01 BOXSTER S/C DE ESTABILIDAD 01-04 A4 QUATTRO 97-01 BOXSTER 00-00 A4 97-00 VOLKSWAGEN PASSAT 96-97, 99		CHRYSLER 300M 99-01 INTREPID 98-00 CONCORDE 98-00 INTREPID C/ABS 01-01 CONCORDE C/ABS 03-04 300M EXCEPTO HEAVY DUTY 02-04 CONCORDE C/ABS 01-02	
PORSCHE 911 CARRERA 4X4 98-98 06-06 01-04					









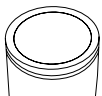

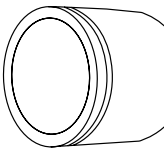

Fotografías de producto y especificaciones

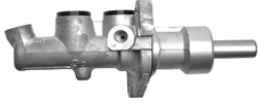
No. Lusac: 390441 Producto: CILINDRO MAESTRO 		No. Lusac: 390445 Producto: CILINDRO MAESTRO 		No. Lusac: 390446 Producto: CILINDRO MAESTRO 	
DIAMETRO	1"	DIAMETRO	1"	DIAMETRO	1.00"
NISSAN FRONTIER 2.4 01-02		FORD GRAND MARQUIS S/C DE TRACCIÓN 97-00		LINCOLN TOWN CAR C/ABS S/C DE TRACCIÓN 98-00	
LINCOLN CONTINENTAL 98-99					
No. Lusac: 390447 Producto: CILINDRO MAESTRO 		No. Lusac: 390448 Producto: CILINDRO MAESTRO 		No. Lusac: 390449 Producto: CILINDRO MAESTRO 	
DIAMETRO	15/16"	DIAMETRO	15/16"	DIAMETRO	15/16"
FORD ESCORT AUTOMÁTICA S/ABS 97-97 ESCORT AUTOMÁTICO S/ABS 01-02		FORD ESCORT VAGONETA 97-99 ESCORT AUTOMÁTICO C/ABS 97-02		FORD ESCORT MANUAL S/ABS 97-97 01-02	
No. Lusac: 390450 Producto: CILINDRO MAESTRO 		No. Lusac: 390451 Producto: CILINDRO MAESTRO 		No. Lusac: 390455 Producto: CILINDRO MAESTRO 	
DIAMETRO	15/16"	DIAMETRO	1"	DIAMETRO	1"
FORD ESCORT MANUAL C/ABS 97-02		NISSAN ALTIMA C/ABS C/CILINDRO TOKICO 96-00		CHEVROLET CAMARO Z28 98-02	
				PONTIAC FIREBIRD TRANS AM 98-01	

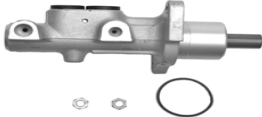



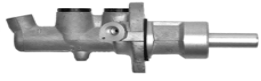

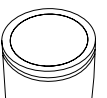

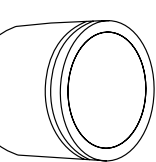

<p>No. Lusac: 390463</p> <p>Producto: CILINDRO MAESTRO</p> 		<p>No. Lusac: 390465</p> <p>Producto: CILINDRO MAESTRO</p> 		<p>No. Lusac: 390468</p> <p>Producto: CILINDRO MAESTRO</p> 	
DIAMETRO	1"	DIAMETRO	1-3/4"	DIAMETRO	25.4 mm 1"
<p>FORD</p> <p>CONTOUR S/ABS 97-00</p>		<p>MERCURY</p> <p>MYSTIQUE S/ABS 97-00</p>		<p>MERCEDEZ BENZ</p> <p>E320 96-05 E280 CON FRENSOS DE TAMBOR 07-09</p>	
				<p>SUBARU</p> <p>IMPREZA WRX LIMITED, 2.5 GT C/ABS 06-06 IMPREZA WRX TR, 2.5 GT C/ABS 06-06 IMPREZA WRX, 2.5 GT C/ABS 06-06</p> <p>FORESTER 03-08 IMPREZA WRX, 2.5 GT AUTOMÁTICO 03-03</p>	
<p>No. Lusac: 390472</p> <p>Producto: CILINDRO MAESTRO</p> 		<p>No. Lusac: 390479</p> <p>Producto: CILINDRO MAESTRO</p> 		<p>No. Lusac: 390480</p> <p>Producto: CILINDRO MAESTRO</p> 	
DIAMETRO	1"	DIAMETRO	15/16"	DIAMETRO	13/16" & 3/4"
<p>CHEVROLET</p> <p>CORVETTE 97-04</p>		<p>BMW</p> <p>Z3 96-02 328i 96-00</p>		<p>BMW</p> <p>540i 97-97 528iA 96-97</p>	
<p>No. Lusac: 390483</p> <p>Producto: CILINDRO MAESTRO</p> 		<p>No. Lusac: 390488</p> <p>Producto: CILINDRO MAESTRO</p> 		<p>No. Lusac: 390491</p> <p>Producto: CILINDRO MAESTRO</p> 	
DIAMETRO	1"	DIAMETRO	15/16"	DIAMETRO	1" & 3/4"
<p>INFINITI</p> <p>Q45 C/CILINDRO TOKICO 97-01</p>		<p>MERCEDEZ BENZ</p> <p>C230K 99-00 C280 VAGONETA 98-99 C230 97-98 SLK230K KOMPRESSOR 97-04</p> <p>C230K 96-96 C280 95-00</p>		<p>MERCEDEZ BENZ</p> <p>SL320 95-97 SL500 95-97</p> <p>E280 07-09</p>	



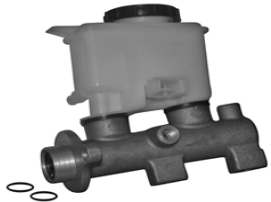
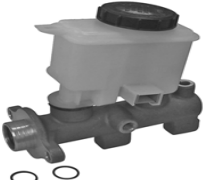
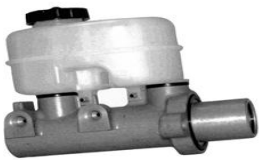

Fotografías de producto y especificaciones

No. Lusac: 390500 Producto: CILINDRO MAESTRO		No. Lusac: 390508 Producto: CILINDRO MAESTRO		No. Lusac: 390514 Producto: CILINDRO MAESTRO	
					
DIAMETRO	15/16"	DIAMETRO	15/16"	DIAMETRO	15/16"
AUDI A3 1.8 4 L TURBO 02-03 JETTA A4 TDI DIESEL 06-07 TT COUPE 00-06 JETTA A4 EUROPA S/C DE ESTABILIDAD 02-08 TT COUPE S/C DE ESTABILIDAD 00-06 JETTA A4 TRENDLINE S/C DE ESTABILIDAD 02-08 TT QUATTRO S/C DE ESTABILIDAD 00-02 NEW BEETLE S/C DE ESTABILIDAD 02-05 TT ROADSTER S/C DE ESTABILIDAD 00-02 BEETLE GLS GLX 1.8 4 L TURBO 01-03 VOLKSWAGEN NEW BEETLE 98-01 GOLF A4 GTI 2 4 L OHC S/ABS S/C DE ESTABILIDAD 00-05 JETTA A4 TDI DIESEL S/C DE ESTABILIDAD 08-08 BEETLE GLS GLX 1.8 4 L TURBO 00-01 00-00		DODGE DAKOTA 99-04 VIPER 08-10 04-06 DURANGO 99-04		FORD ESCORT MANUAL S/ABS 97-99 01-02	
No. Lusac: 390515 Producto: CILINDRO MAESTRO		No. Lusac: 390516 Producto: CILINDRO MAESTRO		No. Lusac: 390521 Producto: CILINDRO MAESTRO	
					
DIAMETRO	15/16"	DIAMETRO	1-1/4"	DIAMETRO	1"
FORD ESCORT AUTOMÁTICA S/ABS 97-99 ESCORT AUTOMÁTICO S/ABS 01-02 ESCORT VAGONETA AUTOMÁTICA S/ABS 97-97		CHRYSLER GRAND VOYAGER S/C DE TRACCIÓN 97-00 RAM VAN 1500 96-03 TOWN & COUNTRY S/C DE TRACCIÓN 97-00 RAM VAN 2500 96-03 VOYAGER 97-00 RAM WAGON 1500 96-03 DODGE RAM 3500 MAXI WAGON 98-02 RAM WAGON 2500 96-02 RAM VAN 3500 98-02		INFINITI Q45 C/CILINDRO NABCO 97-01	
No. Lusac: 390525 Producto: CILINDRO MAESTRO		No. Lusac: 390526 Producto: CILINDRO MAESTRO		No. Lusac: 390527 Producto: CILINDRO MAESTRO	
					
DIAMETRO	1"	DIAMETRO	1-5/16"	DIAMETRO	1-1/16"
FORD MUSTANG GT 6 V S/C DE TRACCIÓN 99-04		FORD E150 ECONOLINE VAN 05-07 ESCAPE 05-06 E250 ECONOLINE VAN S/C DE VELOCIDAD 03-03 01-01		FORD MUSTANG GT 8 V S/C DE TRACCIÓN 99-04 MUSTANG GT S/ABS 98-98	

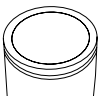

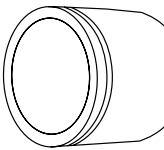



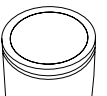

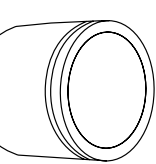



<p>No. Lusac: 390528 Producto: CILINDRO MAESTRO</p> 		<p>No. Lusac: 390530 Producto: CILINDRO MAESTRO</p> 		<p>No. Lusac: 390531 Producto: CILINDRO MAESTRO</p> 	
DIAMETRO	1-1/16"	DIAMETRO	1-3/8"	DIAMETRO	1-3/8"
<p>FORD</p> <p>MUSTANG GT C/C DE TRACCIÓN 99-04</p>		<p>FORD</p> <p>F350 SUPER DUTY, XL, XLT 5.4 8 V OHC C/C DE VELOCIDAD 05-07</p> <p>F450 03-08</p> <p>F550 C/C DE VELOCIDAD 01-07</p> <p>EXCURSION 4X2 S/C DE VELOCIDAD 01-05</p> <p>EXCURSION C/C DE VELOCIDAD 00</p>		<p>FORD</p> <p>F250 XL 4X2 S/C DE VELOCIDAD 99-99</p> <p>F350 SUPER DUTY, XL, XLT S/C DE VELOCIDAD 03-04</p> <p>F350 SUPER DUTY, XL, XLT 5.4 8 V OHC S/C DE VELOCIDAD 99-99</p> <p>F350 SUPER DUTY, XL, XLT S/C DE VELOCIDAD 99-99</p> <p>F350 SUPER DUTY, XL, XLT 5.4 8 V OHC S/C DE VELOCIDAD 99-00</p> <p>F350 SUPER DUTY, XL, XLT S/C DE VELOCIDAD 99-00</p> <p>F350 SUPER DUTY, XL, XLT 5.4 8 V OHC S/C DE VELOCIDAD 07-07 06-07 05-06 04-05</p> <p>F350 SUPER DUTY, XL, XLT S/C DE VELOCIDAD 04-04</p> <p>F450 S/C DE VELOCIDAD 03-08</p> <p>F350 SUPER DUTY, XL, XLT 5.4 8 V OHC S/C DE VELOCIDAD 03-04</p> <p>F350 SUPER DUTY, XL, XLT 5.4 8 V OHC S/C DE VELOCIDAD 02-03</p> <p>F350 SUPER DUTY, XL, XLT S/C DE VELOCIDAD 02-03</p> <p>F550 S/C DE VELOCIDAD 01-07</p> <p>F350 SUPER DUTY, XL, XLT 5.4 8 V OHC S/C DE VELOCIDAD 01-02</p> <p>F350 SUPER DUTY, XL, XLT S/C DE VELOCIDAD 01-02</p> <p>F350 SUPER DUTY, XL, XLT 5.4 8 V OHC S/C DE VELOCIDAD 00-01</p> <p>F350 SUPER DUTY, XL, XLT S/C DE VELOCIDAD 00-01</p>	
<p>No. Lusac: 390534 Producto: CILINDRO MAESTRO</p> 		<p>No. Lusac: 390536 Producto: CILINDRO MAESTRO</p> 		<p>No. Lusac: 390541 Producto: CILINDRO MAESTRO</p> 	
DIAMETRO	1"	DIAMETRO	1-5/16"	DIAMETRO	34mm
<p>CHRYSLER</p> <p>GRAND VOYAGER 97-00</p> <p>TOWN & COUNTRY C/C DE TRACCIÓN 97-00</p> <p>VOYAGER S/C DE TRACCIÓN 97-00</p>		<p>DODGE</p> <p>GRAND CARAVAN S/C DE TRACCIÓN 98-00</p>		<p>FORD</p> <p>E350 ECONOLINE CLUB WAGON 97-98</p> <p>E250 ECONOLINE VAN C/C DE VELOCIDAD 03-03 01-01</p>	
<p>CADILLAC</p> <p>ESCALADE 03-03 03-03 02-03 02-02</p>		<p>CHEVROLET</p> <p>C1500 99-99</p> <p>C2500 4X2 96-99</p> <p>K2500 4X4 96-99</p> <p>SILVERADO 1500 4X2 03-06</p> <p>SILVERADO 1500 4X4 03-06</p> <p>SILVERADO 2500 CHEYENNE 02-04</p> <p>SILVERADO 1500 02-02</p>		<p>SILVERADO 1500HD 02-02</p> <p>TAHOE 01-02</p> <p>SILVERADO 1500 4X2 00-01</p> <p>SILVERADO 1500 4X4 00-01</p> <p>TAHOE 4.8 8 V 00-00</p> <p>TAHOE 5.3 8 V OHV 00-00</p> <p>GMC</p> <p>SIERRA 1500HD 01-02</p>	



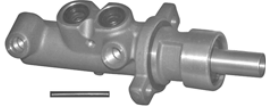





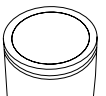

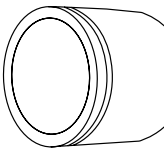



Fotografías de producto y especificaciones

No. Lusac: 390542 Producto: CILINDRO MAESTRO		No. Lusac: 390546 Producto: CILINDRO MAESTRO		No. Lusac: 390550 Producto: CILINDRO MAESTRO	
					
DIAMETRO	37mm	DIAMETRO	23.8 mm 15/16"	DIAMETRO	15/16"
CHEVROLET C1500 99-99 SONORA 01-02 C3500 99-99 TAHOE 01-02 C3500HD 99-99 SUBURBAN 2500 00-02 C2500 4X2 96-99 SILVERADO 1500 4X2 00-01 K2500 4X4 96-99 SILVERADO 1500 4X4 00-01 SILVERADO 1500 4X2 04-06 SILVERADO 1500 4X4 04-06 SILVERADO 2500 CHEYENNE 02-04 SILVERADO 1500 02-02 SILVERADO 1500HD 02 SILVERADO 2500HD 02 SILVERADO 3500 01-06 SUBURBAN 1500 01-03		CHEVROLET TRACKER 99-04 TRACKER S/ABS 00-04		HONDA CIVIC EX, SI SEDAN C/ABS 99-01	
GMC SIERRA 2500 99-02 SIERRA 1500HD 01-02 SIERRA 2500HD 01-02					
HUMMER H2 SUT C/ABS C/C DE TRACCIÓN 05-07 H2 SUV C/ABS C/C DE TRACCIÓN 05-05					
No. Lusac: 390551 Producto: CILINDRO MAESTRO		No. Lusac: 390552 Producto: CILINDRO MAESTRO		No. Lusac: 390553 Producto: CILINDRO MAESTRO	
					
DIAMETRO	26.9 mm 1-1/16"	DIAMETRO	1"	DIAMETRO	1"
ACURA MDX 01-02		BUICK LESABRE 00-03		FORD CONTOUR C/ABS C/C DE TRACCIÓN 96-00	
HONDA ODYSSEY 00-04		CADILLAC DEVILLE 00-04			
No. Lusac: 390555 Producto: CILINDRO MAESTRO		No. Lusac: 390556 Producto: CILINDRO MAESTRO		No. Lusac: 390564 Producto: CILINDRO MAESTRO	
					
DIAMETRO	1"	DIAMETRO	1-1/16"	DIAMETRO	1"
FORD THUNDERBIRD 02-05		HONDA ODYSSEY 00-04		ACURA 3.2TL 99-03	
JAGUAR S TYPE S/C DE ESTABILIDAD 00-05				HONDA ACCORD 3.6 V S/ABS 01-02	
LINCOLN LS 00-06					

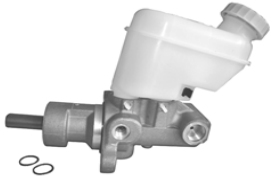





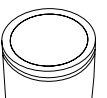

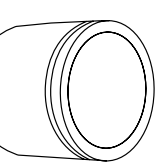





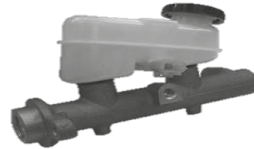

No. Lusac: 390569 Producto: CILINDRO MAESTRO		No. Lusac: 390570 Producto: CILINDRO MAESTRO		No. Lusac: 390571 Producto: CILINDRO MAESTRO	
					
DIAMETRO	1"	DIAMETRO	1-1/16"	DIAMETRO	1"
FORD GRAND MARQUIS C/C DE TRACCIÓN 98-00		LINCOLN TOWN CAR C/ABS C/C DE TRACCIÓN 98-00		CHEVROLET BLAZER C/CILINDRO MARCHADO DX 00-05 S-10 00-04	
		FORD WINDSTAR S/C DE TRACCIÓN 99-00		SONOMA 00-04 OLDSMOBILE BRAVADA C/CILINDRO MARCHADO DX 00-01	
No. Lusac: 390573 Producto: CILINDRO MAESTRO		No. Lusac: 390577 Producto: CILINDRO MAESTRO		No. Lusac: 390579 Producto: CILINDRO MAESTRO	
					
DIAMETRO	1-1/16"	DIAMETRO	15/16"	DIAMETRO	7/8"
FORD WINDSTAR C/C DE TRACCIÓN 99-01		CHRYSLER PT CRUISER CONVERTIBLE C/ABS 05-05 NEON SRT4 C/ABS 04-05 NEON SEDAN C/ABS INCLUYE R/T 03-05 PT CRUISER TURBO C/ABS 03-05		CHRYSLER PT CRUISER C/ABS 01-05 NEON SEDAN C/ABS INCLUYE 00-02 NEON SEDAN INCLUYE R/T 00-05	
No. Lusac: 390581 Producto: CILINDRO MAESTRO		No. Lusac: 390582 Producto: CILINDRO MAESTRO		No. Lusac: 390584 Producto: CILINDRO MAESTRO	
					
DIAMETRO	1"	DIAMETRO	1"	DIAMETRO	1"
FORD WINDSTAR C/ABS C/C DE TRACCIÓN 00-03		FORD WINDSTAR S/C DE TRACCIÓN 99-03		MERCURY VILLAGER S/ABS 99-00	
				NISSAN QUEST S/ABS 99-02	





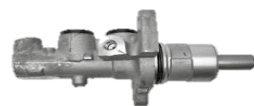

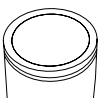

Fotografías de producto y especificaciones

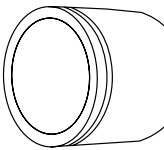
<p>No. Lusac: 390590 Producto: CILINDRO MAESTRO</p> 	<p>No. Lusac: 390592 Producto: CILINDRO MAESTRO</p> 	<p>No. Lusac: 390593 Producto: CILINDRO MAESTRO</p> 
<p>DIAMETRO 2"</p>	<p>DIAMETRO 34mm</p>	<p>DIAMETRO 1"</p>
<p>FORD EXCURSION 4X2 S/C DE VELOCIDAD 01-04 EXCURSION S/C DE VELOCIDAD 00-00</p>	<p>CADILLAC DEVILLE 00-05</p>	<p>VOLVO V70 S/C DE TRACCIÓN 99-04 C70 S/C DE TRACCIÓN 98-01 S70 S/C DE TRACCIÓN 99-00</p>
<p>No. Lusac: 390594 Producto: CILINDRO MAESTRO</p> 	<p>No. Lusac: 390608 Producto: CILINDRO MAESTRO</p> 	<p>No. Lusac: 390613 Producto: CILINDRO MAESTRO</p> 
<p>DIAMETRO 1"</p>	<p>DIAMETRO 1"</p>	<p>DIAMETRO 1"</p>
<p>VOLVO V70 C/C DE TRACCIÓN 99-04 C70 C/C DE TRACCIÓN 98-01 S70 C/C DE TRACCIÓN 99-00</p>	<p>MERCURY SABLE 3 6 V C/C DE TRACCIÓN 00-04</p>	<p>AUDI A4 AVANT S/C DE ESTABILIDAD 98-01 A4 QUATTRO S/C DE ESTABILIDAD 01-01 A6 C/C DE TRACCIÓN 98-01 A4 00-01 A6 QUATTRO C/C DE TRACCIÓN 98-01 S4 00-01 A4 QUATTRO S/C DE ESTABILIDAD 97-99 A8 QUATTRO 97-10 S8 QUATTRO S/C DE ESTABILIDAD 01-02</p> <p>VOLKSWAGEN PASSAT 00-01</p>
<p>No. Lusac: 390615 Producto: CILINDRO MAESTRO</p> 	<p>No. Lusac: 390618 Producto: CILINDRO MAESTRO</p> 	<p>No. Lusac: 390621 Producto: CILINDRO MAESTRO</p> 
<p>DIAMETRO 25.4 mm 1"</p>	<p>DIAMETRO 1" & 3/4"</p>	<p>DIAMETRO 1 1/6 & 1"</p>
<p>NISSAN QUEST XE C/ABS 01-02</p>	<p>MERCEDEZ BENZ E430 99-02 E320 96-05</p>	<p>MERCEDEZ BENZ S420L 96-97 S420 94-95</p>
<p>No. Lusac: 390624 Producto: CILINDRO MAESTRO</p> 	<p>No. Lusac: 390632 Producto: CILINDRO MAESTRO</p> 	<p>No. Lusac: 390633 Producto: CILINDRO MAESTRO</p> 
<p>DIAMETRO 15/16" & 3/4"</p>	<p>DIAMETRO 1"</p>	<p>DIAMETRO 1" & 13/16"</p>
<p>MERCEDEZ BENZ CLK320 98-03 SLK320 01-04 SLK230K KOMPRESSOR 97-04</p>	<p>BMW 540i S/ABS 98-03 525i 01-01 528iA C/ABS 98-00 530i C/ABS 01-03</p>	<p>BMW 740i 99-01 M5 02-03 M5 99-00 530i S/ABS 01-03 740iLA 98-01 540i C/ABS 01-03 528iA S/ABS 98-00 X5 00-01 525i 02-03</p>

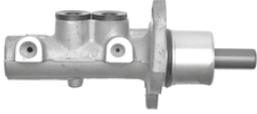
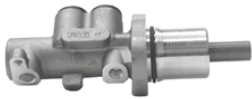

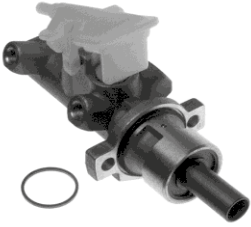
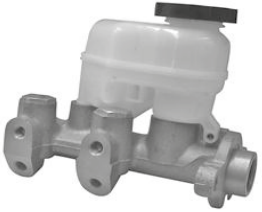
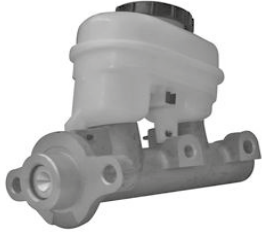



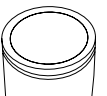

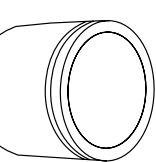



<p>No. Lusac: 390636</p> <p>Producto: CILINDRO MAESTRO</p> 		<p>No. Lusac: 390637</p> <p>Producto: CILINDRO MAESTRO</p> 		<p>No. Lusac: 390638</p> <p>Producto: CILINDRO MAESTRO</p> 	
DIAMETRO	15/16"	DIAMETRO	1"	DIAMETRO	15/16"
<p>PORSCHE</p> <p>911 CARRERA S/C DE TRACCIÓN 98-06 BOXSTER BASE 01-04</p> <p>BOXSTER 97-99 BOXSTER 01-04</p> <p>911 CARRERA 97-97</p>		<p>AUDI</p> <p>A8 QUATTRO S/C DE TRACCIÓN 98-10 S8 QUATTRO 01-02</p> <p>A8 S/C DE TRACCIÓN 97-97</p> <p>ALLROAD 01-04</p>		<p>CHRYSLER</p> <p>PT CRUISER S/ABS 05-05 PT CRUISER S/ABS 01-03</p> <p>NEON SRT4 S/ABS 04-04 NEON SEDAN S/ABS INCLUYE R/T 00-05</p> <p>PT CRUISER S/ABS 04-04</p>	
<p>No. Lusac: 390639</p> <p>Producto: CILINDRO MAESTRO</p> 		<p>No. Lusac: 390643</p> <p>Producto: CILINDRO MAESTRO</p> 		<p>No. Lusac: 390645</p> <p>Producto: CILINDRO MAESTRO</p> 	
DIAMETRO	15/16"	DIAMETRO	15/16"	DIAMETRO	1"
<p>INFINITI</p> <p>I35 02-03 NISSAN</p> <p>I30 00-00 MAXIMA 00-03</p>		<p>FORD</p> <p>FOCUS EUROPA S/ABS 07 FOCUS S/ABS 00-04</p> <p>FOCUS LX S/ABS 05-07</p>		<p>CHEVROLET</p> <p>IMPALA S/ABS 00-04</p>	
<p>No. Lusac: 390646</p> <p>Producto: CILINDRO MAESTRO</p> 		<p>No. Lusac: 390654</p> <p>Producto: CILINDRO MAESTRO</p> 		<p>No. Lusac: 390655</p> <p>Producto: CILINDRO MAESTRO</p> 	
DIAMETRO	7/8"	DIAMETRO	1"	DIAMETRO	1"
<p>CHEVROLET</p> <p>CAVALIER 00-02 PONTIAC</p> <p>CAVALIER 2.2 4 L 00-02 SUNFIRE 00-05</p>		<p>FORD</p> <p>MONDEO SPORT XLS C/ABS 03-04 MITSUBISHI</p> <p>MONTERO SPORT 3.5 6 V OHC C/ABS 03-04</p>		<p>FORD</p> <p>MONDEO SPORT XLS S/ABS 03-04 MITSUBISHI</p> <p>MONTERO SPORT 3.5 6 V OHC S/ABS 03-04</p>	





Fotografías de producto y especificaciones

No. Lusac: 390657 Producto: CILINDRO MAESTRO 		No. Lusac: 390660 Producto: CILINDRO MAESTRO 		No. Lusac: 390661 Producto: CILINDRO MAESTRO 	
DIAMETRO	1-1/16"	DIAMETRO	1-1/16"	DIAMETRO	1-1/16"
CHRYSLER STRATUS C/ABS C/C DE TRACCIÓN 02-05		CHRYSLER STRATUS C/ABS 05-05 ECLIPSE C/ABS 01-02 STRATUS C/ABS S/C DE TRACCIÓN 02-04 GALANT DE 6 V 01-01 SEBRING COUPE C/ABS S/C DE TRACCIÓN 01-05 GALANT DE 2.4 L C/ABS 00-02 MITSUBISHI GALANT DE S/C DE TRACCIÓN 02-02 GALANT DE 6 V 00-01		CHRYSLER STRATUS S/ABS 03-06 GALANT 4 L S/ABS 03-03 SEBRING COUPE S/ABS S/C DE TRACCIÓN 01-05 ECLIPSE S/ABS 01-02 MITSUBISHI GALANT DE 2.4 L S/ABS 00-02 ECLIPSE GT S/ABS 03-05	
No. Lusac: 390663 Producto: CILINDRO MAESTRO 		No. Lusac: 390666 Producto: CILINDRO MAESTRO 		No. Lusac: 390676 Producto: CILINDRO MAESTRO 	
DIAMETRO	15/16"	DIAMETRO	22.2 mm 7/8"	DIAMETRO	24mm
AUDI TT QUATTRO 00-02 TT ROADSTER 00-02		TOYOTA MR2 05-06		CHEVROLET PONTIAC MALIBU LX, LS 3.1 6 V C/ABS 02-03 GRAND AM 01-05	
No. Lusac: 390678 Producto: CILINDRO MAESTRO 		No. Lusac: 390690 Producto: CILINDRO MAESTRO 		No. Lusac: 390691 Producto: CILINDRO MAESTRO 	
DIAMETRO	15/16"	DIAMETRO	1"	DIAMETRO	1"
FORD FOCUS SVT C/ABS S/C DE TRACCIÓN 02-02 FOCUS ZX3 C/ABS S/C DE TRACCIÓN 00-04 FOCUS C/ABS S/C DE TRACCIÓN 00-04		FORD ESCAPE 4X2 AUTOMÁTICA 01-04		FORD ESCAPE 4X4 MANUAL 01-04	

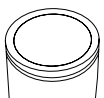

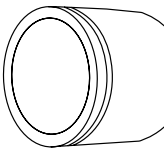



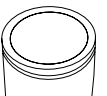

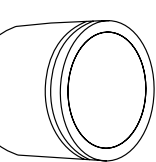

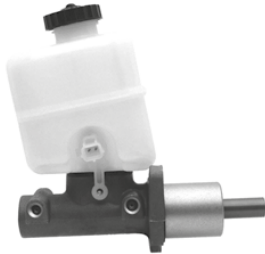
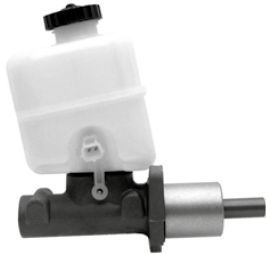

No. Lusac: 390693 Producto: CILINDRO MAESTRO		No. Lusac: 390695 Producto: CILINDRO MAESTRO		No. Lusac: 390696 Producto: CILINDRO MAESTRO	
					
DIAMETRO	1"	DIAMETRO	1-1/16"	DIAMETRO	1-1/16"
FORD GRAND MARQUIS S/C DE TRACCIÓN 01-04 LINCOLN TOWN CAR S/C DE TRACCIÓN 10-11		FORD F150 S/C DE VELOCIDAD 00-03		FORD RANGER S/C DE VELOCIDAD 01-01 01-01 MAZDA B2300 C/C DE VELOCIDAD 08-08 B2300 S/C DE VELOCIDAD 01-01 B3000 S/C DE VELOCIDAD 02-07 B3000 C/C DE VELOCIDAD 02-07 B2300 S/C DE VELOCIDAD 01-01 B3000 C/C DE VELOCIDAD 08-08	
No. Lusac: 390697 Producto: CILINDRO MAESTRO		No. Lusac: 390698 Producto: CILINDRO MAESTRO		No. Lusac: 390702 Producto: CILINDRO MAESTRO	
					
DIAMETRO	1"	DIAMETRO	13/16"	DIAMETRO	1"
CHEVROLET TRAILBLAZER LS, LT 4X2 06-06 05-06 04-05 03-04 02-03 02-02		OLDSMOBILE BRAVADA 02-04		MERCEDEZ BENZ CL600 99-99 CL600 01-06 CL500 99-06 S55AMG 01-06 S350 06-06 S430 00-05 S500L 03-06 S600L 02-02	
FORD GRAND MARQUIS C/C DE TRACCIÓN 01-04		LINCOLN TOWN CAR C/C DE TRACCIÓN 01-11			
No. Lusac: 390707 Producto: CILINDRO MAESTRO		No. Lusac: 390708 Producto: CILINDRO MAESTRO		No. Lusac: 390709 Producto: CILINDRO MAESTRO	
					
DIAMETRO	23.8 mm 15/16"	DIAMETRO	15/16"	DIAMETRO	1-1/16"
CHEVROLET TRACKER C/ABS 00-04		CHRYSLER TOWN & COUNTRY S/C DE TRACCIÓN 07-07 TOWN & COUNTRY S/C DE TRACCIÓN 05-06 TOWN & COUNTRY S/C DE TRACCIÓN 03-04 VOYAGER 01-08 TOWN & COUNTRY S/C DE TRACCIÓN 01-02		DODGE CARAVAN S/ABS 06-07 CARAVAN 01-05 GRAND CARAVAN 01-05	
		CHRYSLER VOYAGER EXCEPTO CONTROL DE TRACCIÓN 01-04 GRAND VOYAGER S/C DE TRACCIÓN 01-02 TOWN & COUNTRY S/C DE TRACCIÓN 01-02		DODGE CARAVAN S/C DE TRACCIÓN 01-02 GRAND CARAVAN S/C DE TRACCIÓN 01-02	

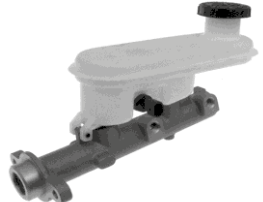







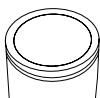

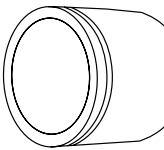

Fotografías de producto y especificaciones

No. Lusac: 390710 Producto: CILINDRO MAESTRO 		No. Lusac: 390711 Producto: CILINDRO MAESTRO 		No. Lusac: 390712 Producto: CILINDRO MAESTRO 	
DIAMETRO	1-1/16"	DIAMETRO	1-1/16"	DIAMETRO	1-1/16"
CHRYSLER TOWN & COUNTRY C/C DE TRACCIÓN 01-06 GRAND VOYAGER C/C DE TRACCIÓN 01-02 VOYAGER 01-02		DODGE CARAVAN C/C DE TRACCIÓN 01-02 GRAND CARAVAN 01-02		JEEP LIBERTY CON MANEJO DE LADO DERECHO 02-06	
No. Lusac: 390713 Producto: CILINDRO MAESTRO 		No. Lusac: 390714 Producto: CILINDRO MAESTRO 		No. Lusac: 390719 Producto: CILINDRO MAESTRO 	
DIAMETRO	25.4 mm 1"	DIAMETRO	25.4 mm 1"	DIAMETRO	15/16"
SAAB 9-5 SEDAN 01-02 9-5 WAGON 01-02		PONTIAC AZTEK 01-05		CHRYSLER 300M 01-04 CONCORDE S/ABS 01-04	
DODGE INTREPID S/ABS 01-01		No. Lusac: 390720 Producto: CILINDRO MAESTRO 		No. Lusac: 390721 Producto: CILINDRO MAESTRO 	
DIAMETRO	25.4 mm 1"	DIAMETRO	15/16"	DIAMETRO	7/8"
CHRYSLER STRATUS SEDAN 02-06		ACURA RSX 02-06		HONDA CR-V 02-04	
No. Lusac: 390724 Producto: CILINDRO MAESTRO 		No. Lusac: 390730 Producto: CILINDRO MAESTRO 		No. Lusac: 390732 Producto: CILINDRO MAESTRO 	
DIAMETRO	7/8"	DIAMETRO	15/16"	DIAMETRO	1-5/16"
DODGE VERNA 04-06		HONDA CR-V 02-04		DODGE RAM 4000 02-02 RAM 2500 01-02	
				DODGE RAM 3500 00-02	

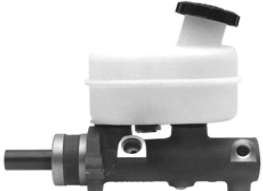

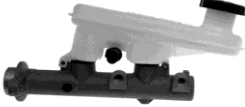



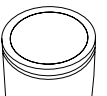

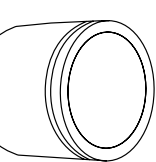



No. Lusac: 390734 Producto: CILINDRO MAESTRO 		No. Lusac: 390735 Producto: CILINDRO MAESTRO 		No. Lusac: 390739 Producto: CILINDRO MAESTRO 	
DIAMETRO	13/16"	DIAMETRO	20.6 mm 13/16"	DIAMETRO	1"
TOYOTA COROLLA CE, LE MANUAL 08-08 07-08 06-07 COROLLA S MANUAL 05-08 COROLLA CE, LE MANUAL 05-06 04-05 MATRIX XR 03-08 COROLLA CE, LE MANUAL 03-04 03-03		PONTIAC VIBE 05-08 TOYOTA COROLLA CE, LE AUTOMÁTICA 08 08 07-08 06-07 COROLLA S AUTOMÁTICA 05-08 COROLLA CE, LE AUTOMÁTICA 05 06 04-05 04-04 MATRIX XR 03-08 COROLLA CE, LE AUTOMÁTICA 03 03 03-03		CHEVROLET EQUINOX 05-06 PONTIAC TORRENT 06-06	
No. Lusac: 390740 Producto: CILINDRO MAESTRO 		No. Lusac: 390741 Producto: CILINDRO MAESTRO 		No. Lusac: 390742 Producto: CILINDRO MAESTRO 	
DIAMETRO	1-1/4"	DIAMETRO	1-1/8"	DIAMETRO	1-5/16"
FORD EXPEDITION INLCUYE EDDIE BAUER 4X2 02 EXPEDITION INLCUYE EDDIE BAUER 4X4 02		FORD E150 ECONOLINE VAN 02-03		DODGE RAM 2500 11 RAM 2500 HD 08-10 RAM 1500 07-08 RAM 1500 05-06 RAM 1500 4X4 03-04	
No. Lusac: 390745 Producto: CILINDRO MAESTRO 		No. Lusac: 390746 Producto: CILINDRO MAESTRO 		No. Lusac: 390747 Producto: CILINDRO MAESTRO 	
DIAMETRO	1"	DIAMETRO	13/16"	DIAMETRO	5/16"
CHRYSLER 300M 02-04 CONCORDE C/ABS 02-04		HONDA CIVIC LX SEDAN S/ABS 03-06 CIVIC LX, EX SEDAN S/ABS 02-06 02-02		NISSAN SENTRA SE-R 2.5 4 L C/ABS 08-09 SENTRA SE, GXE C/ABS SENTRA SE-R 2.5 4 L C/ABS 02-06 SENTRA SE, GXE C/ABS 02-03 01-02 SENTRA SE C/ABS 01-01 SENTRA SE, GXE C/ABS 01-01	

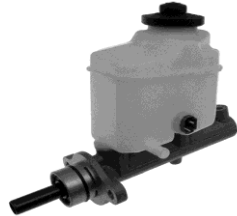







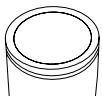

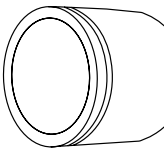

Fotografías de producto y especificaciones

No. Lusac: 390748 Producto: CILINDRO MAESTRO 		No. Lusac: 390749 Producto: CILINDRO MAESTRO 		No. Lusac: 390753 Producto: CILINDRO MAESTRO 	
DIAMETRO	1-1/16"	DIAMETRO	1-1/16"	DIAMETRO	7/8"
NISSAN SENTRA SE-R 2.5 4 L C/ABS 02-06		NISSAN SENTRA SE-R 2.5 4 L S/ABS 05-06		TOYOTA CAMRY LE 02-04	
No. Lusac: 390754 Producto: CILINDRO MAESTRO 		No. Lusac: 390758 Producto: CILINDRO MAESTRO 		No. Lusac: 390759 Producto: CILINDRO MAESTRO 	
DIAMETRO	7/8"	DIAMETRO	1"	DIAMETRO	22.2 mm 7/8"
TOYOTA SOLARA MANUAL 07-08 CAMRY LE S/ABS 02-04 CAMRY LE, XLE S/ABS 06-06 05-06 05-05 SOLARA MANUAL 04-04		CADILLAC SRX 04-04 CTS 03-04		MITSUBISHI LANCER LS ES AUTOMÁTICO S/ABS 04-06	
No. Lusac: 390760 Producto: CILINDRO MAESTRO 		No. Lusac: 390762 Producto: CILINDRO MAESTRO 		No. Lusac: 390763 Producto: CILINDRO MAESTRO 	
DIAMETRO	7/8"	DIAMETRO	1-1/8"	DIAMETRO	28.5 mm 1-1/8"
MITSUBISHI LANCER RALLIART S/ABS 05-06 LANCER S/ABS 04-05		FORD EXPEDITION 03-06		LINCOLN NAVIGATOR S/C DE ESTABILIDAD 03-06	
				LINCOLN NAVIGATOR 03-06	

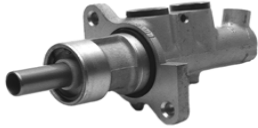



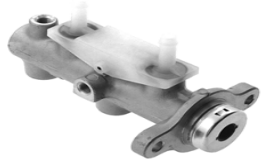

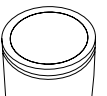

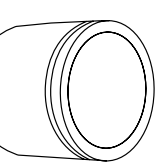



<p>No. Lusac: 390764</p> <p>Producto: CILINDRO MAESTRO</p> 		<p>No. Lusac: 390765</p> <p>Producto: CILINDRO MAESTRO</p> 		<p>No. Lusac: 390766</p> <p>Producto: CILINDRO MAESTRO</p> 	
DIAMETRO	15/16"	DIAMETRO	15/16" & 13/16"	DIAMETRO	1" & 13/16"
<p>INFINITI</p> <p>I35 SPORT 02-03</p>		<p>MERCEDEZ BENZ</p> <p>C230K 02-05 C240 C/ABS 01-02</p>		<p>MERCEDEZ BENZ</p> <p>SL65AMG 09-09 SLK55 08-10 CLK63AMG 08-09 CLS63 08-09 CLK350 06-09 CLS500 06-08 C230 06-07 C350 06-07 SLK350 05-11</p> <p>C55AMG 05-07 SLK55 AMG 05-07 CLK320 04-05 C32 04-04 CLK500 03-06 CLK55AMG 03-06 C32AMG 02-03 C320 01-05</p>	
<p>No. Lusac: 390768</p> <p>Producto: CILINDRO MAESTRO</p> 		<p>No. Lusac: 390772</p> <p>Producto: CILINDRO MAESTRO</p> 		<p>No. Lusac: 390774</p> <p>Producto: CILINDRO MAESTRO</p> 	
DIAMETRO	1" & 7/8"	DIAMETRO	1" & 7/8"	DIAMETRO	25.4 mm 1"
<p>BMW</p> <p>X5 02-06</p>		<p>MERCEDEZ BENZ</p> <p>E55AMG 99-04 CLK430 C/ABS 99-03</p> <p>CLK55AMG 01-02</p>		<p>INFINITI</p> <p>QX4 02-03</p> <p>NISSAN</p> <p>PATHFINDER 03-04 02-02</p>	
<p>No. Lusac: 390777</p> <p>Producto: CILINDRO MAESTRO</p> 		<p>No. Lusac: 390778</p> <p>Producto: CILINDRO MAESTRO</p> 		<p>No. Lusac: 390780</p> <p>Producto: CILINDRO MAESTRO</p> 	
DIAMETRO	1"	DIAMETRO	1"	DIAMETRO	1"
<p>INFINITI</p> <p>Q45 S/ABS 02-02</p>		<p>AUDI</p> <p>A8 QUATTRO 98-10 A8 97-97 S6 QUATTRO 07-11 A4 C/CILINDRO GIRLING 02-09 A4 QUATTRO 02-09 A6 02-04 A6 QUATTRO 02-04</p> <p>S4 02-02 S6 QUATTRO 01-04</p> <p>VOLKSWAGEN</p> <p>PASSAT 4 8 W 4MOTION 03-04 PASSAT 02-05 PASSAT 4MOTION 02-05</p>		<p>MITSUBISHI</p> <p>OUTLANDER S/ABS 03-10</p>	



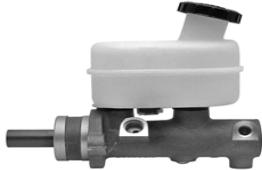

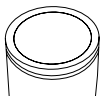

Fotografías de producto y especificaciones

No. Lusac: 390781 Producto: CILINDRO MAESTRO		No. Lusac: 390782 Producto: CILINDRO MAESTRO		No. Lusac: 390783 Producto: CILINDRO MAESTRO	
					
DIAMETRO	1"	DIAMETRO	1-5/16"	DIAMETRO	13/16"
MITSUBISHI OUTLANDER C/ABS 10-10 OUTLANDER C/ABS 03-08 OUTLANDER 09-09		DODGE RAM 1500 ST 4X4 09-10 RAM 1500 4X2 05-06 RAM 1500 4X4 05-08		HONDA ACCORD 03-07	
No. Lusac: 390784 Producto: CILINDRO MAESTRO		No. Lusac: 390787 Producto: CILINDRO MAESTRO		No. Lusac: 390788 Producto: CILINDRO MAESTRO	
					
DIAMETRO	20.6 mm 13/16"	DIAMETRO	1-1/8"	DIAMETRO	1"
HONDA ACCORD 3.6 V 03-07		FORD E150 ECONOLINE VAN S/C DE VELOCIDAD 02-03		CHRYSLER DODGE PACIFICA S/C DE TRACCIÓN 04-06 CARAVAN S/C DE TRACCIÓN 03-05 TOWN & COUNTRY 03-07 GRAND CARAVAN S/C DE TRACCIÓN 03-05	
No. Lusac: 390790 Producto: CILINDRO MAESTRO		No. Lusac: 390800 Producto: CILINDRO MAESTRO		No. Lusac: 390802 Producto: CILINDRO MAESTRO	
					
DIAMETRO	1-1/16"	DIAMETRO	15/16"	DIAMETRO	1-1/4"
FORD EXPLORER SPORT MANUAL 03-03 EXPLORER EDDIE BAUER MANUAL 01-05		NISSAN MAXIMA SE S/ABS 07-08 ALTIMA S, SL, SE SEDAN S/ABS 02-07		FORD LOBO S/C DE VELOCIDAD 01-02	

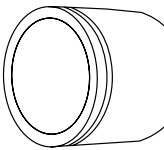





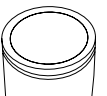

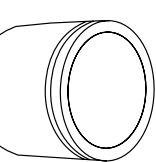



<p>No. Lusac: 390804</p> <p>Producto: CILINDRO MAESTRO</p> 		<p>No. Lusac: 390805</p> <p>Producto: CILINDRO MAESTRO</p> 		<p>No. Lusac: 390806</p> <p>Producto: CILINDRO MAESTRO</p> 	
DIAMETRO	34mm	DIAMETRO	1-1/4"	DIAMETRO	1-1/4"
<p>CADILLAC</p> <p>ESCALADE C/C ACTIVO DE FRENOS 04-06</p>		<p>CHEVROLET</p> <p>TAHOE C/C DE TRACCIÓN 03-06</p>		<p>CADILLAC</p> <p>ESCALADE 06-06 06-06 06-06</p> <p>ESCALADE 04-05</p> <p>ESCALADE 03</p> <p>CHEVROLET</p> <p>AVALANCHE 5.3 8 V 4X4 07-08</p> <p>TAHOE 04-06</p>	
<p>CADILLAC</p> <p>ESCALADE C/C ACTIVO DE FRENOS 03-03 03-03 03-03</p>		<p>CHEVROLET</p> <p>TAHOE C/C DE TRACCIÓN 03-03</p>		<p>TAHOE S/C DE TRACCIÓN 03-03</p> <p>GMC</p> <p>SIERRA 1500 CLASSIC DENALI 07-07</p> <p>SIERRA 1500HD 03</p>	
<p>No. Lusac: 390807</p> <p>Producto: CILINDRO MAESTRO</p> 		<p>No. Lusac: 390808</p> <p>Producto: CILINDRO MAESTRO</p> 		<p>No. Lusac: 390809</p> <p>Producto: CILINDRO MAESTRO</p> 	
DIAMETRO	7/8"	DIAMETRO	7/8"	DIAMETRO	15/16"
<p>HONDA</p> <p>CIVIC SEDAN 02-04</p>		<p>HONDA</p> <p>CIVIC SEDAN 05-05</p> <p>CIVIC SEDAN S/ABS 04-05 04-04</p>		<p>FORD</p> <p>FOCUS C/ABS C/C DE TRACCIÓN 00-04</p>	
<p>No. Lusac: 390810</p> <p>Producto: CILINDRO MAESTRO</p> 		<p>No. Lusac: 390811</p> <p>Producto: CILINDRO MAESTRO</p> 		<p>No. Lusac: 390812</p> <p>Producto: CILINDRO MAESTRO</p> 	
DIAMETRO	1-1/16"	DIAMETRO	1-1/8"	DIAMETRO	1"
<p>FORD</p> <p>FREESTAR 04-05</p> <p>WINDSTAR 02-03</p>		<p>FORD</p> <p>F150 XL 10-12</p> <p>LOBO 10-12</p> <p>F150 XL 04-09</p> <p>LOBO 04-09</p>		<p>LINCOLN</p> <p>MARK LT 06-08</p>	
<p>FORD</p> <p>TAURUS 03-06</p>		<p>MERCURY</p> <p>SABLE 03-05</p>			









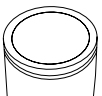

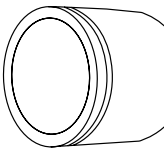



Fotografías de producto y especificaciones

No. Lusac: 390816 Producto: CILINDRO MAESTRO 		No. Lusac: 390818 Producto: CILINDRO MAESTRO 		No. Lusac: 390819 Producto: CILINDRO MAESTRO 	
DIAMETRO	15/16"	DIAMETRO	37mm	DIAMETRO	15/16"
CHRYSLER SEBRING 06-06 SEBRING SEDAN 03-05 SEBRING CONVERTIBLE 04-05 SEBRING 03-03 STRATUS 03-06		CHEVROLET EXPRESS 3500 VAN 07-08 SIERRA 1500HD 05-06 EXPRESS 3500 VAN S/C ACTIVO DE FRENOS 04-06 SIERRA 1500 CLASSIC DENALI 04-05 EXPRESS 2500 CARGO VAN 03-08 SAVANA 2500 EXT 03-07 SILVERADO 1500 03-07 SAVANA 3500 EXT 03-07 SILVERADO 2500 03-07 SIERRA 2500 03-07 SILVERADO 3500 03-07 SIERRA 3500 03-07 AVALANCHE 03-06 SIERRA 2500HD 03-06 SUBURBAN 2500 03-06 YUKON XL 2500 03-06 EXPRESS 3500 VAN 03 SIERRA 1500 CLASSIC DENALI 03-04 GMC SIERRA 03 SIERRA 1500 CLASSIC DENALI 07-07 SIERRA 1500 CLASSIC DENALI S/C DE ESTABILIDAD 03-03 SIERRA 1500HD CLASSIC 05-06 SIERRA 1500HD 03 SIERRA 2500HD CLASSIC 07		FORD FOCUS EUROPA C/ABS S/C DE TRACCIÓN 07-07 FOCUS C/ABS S/C DE TRACCIÓN 00-04 FOCUS LX C/ABS 05-07	
No. Lusac: 390820 Producto: CILINDRO MAESTRO 		No. Lusac: 390821 Producto: CILINDRO MAESTRO 		No. Lusac: 390822 Producto: CILINDRO MAESTRO 	
DIAMETRO	1-3/16"	DIAMETRO	1-5/16"	DIAMETRO	20.6 mm 13/16"
FORD F150 03-03		DODGE RAM 1500 06-06 RAM 1500 3.7 6 V 03-04 RAM 1500 C/ABS 05-05		TOYOTA SIENNA 03-03	
No. Lusac: 390823 Producto: CILINDRO MAESTRO 		No. Lusac: 390824 Producto: CILINDRO MAESTRO 		No. Lusac: 390825 Producto: CILINDRO MAESTRO 	
DIAMETRO	25.4 mm 1"	DIAMETRO	20.6 mm 13/16"	DIAMETRO	7/8"
CHRYSLER PACIFICA 04-06 TOWN & COUNTRY C/ABS 03-07		TOYOTA TACOMA 01-04		TOYOTA RAV4 MANUAL 04-05	







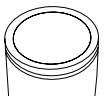

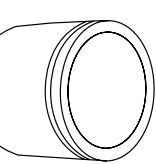







No. Lusac: 390832 Producto: CILINDRO MAESTRO		No. Lusac: 390833 Producto: CILINDRO MAESTRO		No. Lusac: 390835 Producto: CILINDRO MAESTRO	
					
DIAMETRO	7/8"	DIAMETRO	13/16"	DIAMETRO	1"
TOYOTA RAV4 AUTOMÁTICA 04-05 RAV4 03-03		TOYOTA RAV4 AUTOMÁTICA S/C DE ESTABILIDAD 04-05		NISSAN PATHFINDER CON CONTROL DINAMICO 02-04	
No. Lusac: 390838 Producto: CILINDRO MAESTRO		No. Lusac: 390839 Producto: CILINDRO MAESTRO		No. Lusac: 390843 Producto: CILINDRO MAESTRO	
					
DIAMETRO	1"	DIAMETRO	25.4 mm 1"	DIAMETRO	34mm
NISSAN FRONTIER 3.3 6 V 01-02		NISSAN FRONTIER XE 6 V 4X4 AUTOMÁTICA 03-04 XTERRA 4X4 03-04		CADILLAC ESCALADE S/C ACTIVO DE FRENOS 03-06 SILVERADO 1500 4X2 03-03 CHEVROLET EXPRESS 2500 CARGO VAN 04-06 SILVERADO 1500 4X4 04-06 TAHOE S/C DE TRACCIÓN 04-06 EXPRESS 1500 CARGO VAN Y 03-08 SILVERADO 1500 4X2 03-06 GMC SIERRA 1500 CLASSIC 07-07 SAVANA 1500 03-07 SAVANA 2500 EXT 03-05	
No. Lusac: 390845 Producto: CILINDRO MAESTRO		No. Lusac: 390847 Producto: CILINDRO MAESTRO		No. Lusac: 390848 Producto: CILINDRO MAESTRO	
					
DIAMETRO	1"	DIAMETRO	1-1/4"	DIAMETRO	1 5/16"
CHEVROLET COLORADO 4X2 04-08 COLORADO 4X4 04-08		FORD E150 ECONOLINE VAN S/C DE VELOCIDAD 04-04		FORD E250 ECONOLINE VAN 07 E250 ECONOLINE VAN C/C DE VELOCIDAD 03-04	
GMC CANYON 4X2 07-08 CANYON 4X4 07-08					









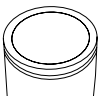

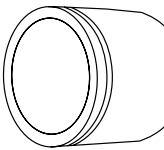





Fotografías de producto y especificaciones

No. Lusac: 390849 Producto: CILINDRO MAESTRO		No. Lusac: 390852 Producto: CILINDRO MAESTRO		No. Lusac: 390853 Producto: CILINDRO MAESTRO	
					
DIAMETRO	1-1/4"	DIAMETRO	1-1/4"	DIAMETRO	1-1/4"
FORD E150 ECONOLINE VAN C/C DE VELOCIDAD 04-05		DODGE DURANGO SLT, LIMITED S/C DE TRACCIÓN 04-06 DURANGO S/C DE TRACCIÓN 03-04		DODGE DURANGO SLT, LIMITED C/C DE TRACCIÓN 004	
No. Lusac: 390854 Producto: CILINDRO MAESTRO		No. Lusac: 390855 Producto: CILINDRO MAESTRO		No. Lusac: 390857 Producto: CILINDRO MAESTRO	
					
DIAMETRO	1"	DIAMETRO	25.4 mm 1"	DIAMETRO	7/8"
NISSAN QUEST 09-09 QUEST S, SE, SL S/C DE TRACCIÓN 04-08		NISSAN QUEST 09-09 QUEST S, SE, SL C/C DE TRACCIÓN 04-08		TOYOTA CAMRY LE, XLE 06-06 05-06 05-05	
No. Lusac: 390858 Producto: CILINDRO MAESTRO		No. Lusac: 390859 Producto: CILINDRO MAESTRO		No. Lusac: 390860 Producto: CILINDRO MAESTRO	
					
DIAMETRO	15/16"	DIAMETRO	15/16"	DIAMETRO	13/16"
NISSAN MAXIMA SE S/C DE ESTABILIDAD 07-08		NISSAN MAXIMA SE 07-08		TOYOTA RAV4 MANUAL 04-05	
No. Lusac: 390863 Producto: CILINDRO MAESTRO		No. Lusac: 390867 Producto: CILINDRO MAESTRO		No. Lusac: 390868 Producto: CILINDRO MAESTRO	
					
DIAMETRO	7/8"	DIAMETRO	1"	DIAMETRO	1"
PONTIAC G3 AUTOMÁTICA S/ABS 07-08		NISSAN FRONTIER 03-04 FRONTIER 4X2 03-04		NISSAN QUEST 99-02	







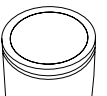

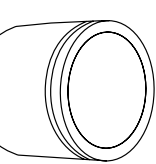



No. Lusac: 390869 Producto: CILINDRO MAESTRO 		No. Lusac: 390870 Producto: CILINDRO MAESTRO 		No. Lusac: 390871 Producto: CILINDRO MAESTRO 	
DIAMETRO	7/8"	DIAMETRO	3/4" & 15/16"	DIAMETRO	N/D
PONTIAC G3 MANUAL S/ABS 07-08		TOYOTA SIENNA C/C DE TRACCIÓN 04-10		TOYOTA SIENNA S/C DE TRACCIÓN 04-10	
No. Lusac: 390873 Producto: CILINDRO MAESTRO 		No. Lusac: 390874 Producto: CILINDRO MAESTRO 		No. Lusac: 390879 Producto: CILINDRO MAESTRO 	
DIAMETRO	25.4 mm 1"	DIAMETRO	1"	DIAMETRO	28.5 mm 1-1/8"
MITSUBISHI LANCER C/ABS 04-05		MITSUBISHI LANCER C/ABS 04-05 LANCER C/ABS 04-04		NISSAN TITAN 4X2 S/CONTROL DINAMICO 04-07	
No. Lusac: 390881 Producto: CILINDRO MAESTRO 		No. Lusac: 390885 Producto: CILINDRO MAESTRO 		No. Lusac: 390886 Producto: CILINDRO MAESTRO 	
DIAMETRO	7/8"	DIAMETRO	23.8 mm 15/16"	DIAMETRO	1"
CHEVROLET AVEO MANUAL C/ABS 08-11		CHEVROLET MALIBU 08-10 MALIBU CLASSIC 08-08 MALIBU LX, LS 2.2 06-07 MALIBU LX, LS 3.5 02-05		MITSUBISHI ENDEAVOR LIMITED C/ABS 11-11 04-08	
PONTIAC G3 AUTOMÁTICA C/ABS 07-08		PONTIAC G6 S/C DE ESTABILIDAD 07-07 G6 05-06			
No. Lusac: 390888 Producto: CILINDRO MAESTRO 		No. Lusac: 390896 Producto: CILINDRO MAESTRO 		No. Lusac: 390897 Producto: CILINDRO MAESTRO 	
DIAMETRO	7/8"	DIAMETRO	26.9 mm 1-1/16"	DIAMETRO	1"
CHEVROLET AVEO AUTOMÁTICA C/ABS 08-11		MITSUBISHI LANCER EVOLUTION IX CON FRENOS BREMBO 06-06 LANCER AUTOMÁTICO S/ABS 04-06		MITSUBISHI GALANT ES S/ABS 04-05	
PONTIAC G3 AUTOMÁTICA S/ABS 07-08					









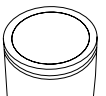

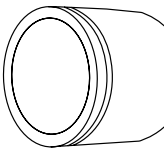
Fotografías de producto y especificaciones

No. Lusac: 390898 Producto: CILINDRO MAESTRO 		No. Lusac: 390899 Producto: CILINDRO MAESTRO 		No. Lusac: 390908 Producto: CILINDRO MAESTRO 	
DIAMETRO	7/8"	DIAMETRO	15/16"	DIAMETRO	1"
TOYOTA SOLARA AUTOMÁTICO S/C DE TRACCIÓN 07-08 SOLARA 05-06 SOLARA AUTOMÁTICO S/C DE TRACCIÓN 04-04		TOYOTA SOLARA AUTOMÁTICO C/C DE TRACCIÓN 07-08 CAMRY LE, XLE 2.4 L DOHC 06-06 05-06 SOLARA AUTOMÁTICO C/C DE TRACCIÓN 04-04 SOLARA C/C DE TRACCIÓN 05-06		CADILLAC SRX 05-09 STS 05-08 CTS 05-07	
No. Lusac: 390909 Producto: CILINDRO MAESTRO 		No. Lusac: 390910 Producto: CILINDRO MAESTRO 		No. Lusac: 390915 Producto: CILINDRO MAESTRO 	
DIAMETRO	1-1/16"	DIAMETRO	1"	DIAMETRO	20.6 mm 13/16"
FORD ESCAPE 08-08 07-08 07-07 ESCAPE LIMITED Y XLT AUTOMÁTICA 06-06 05-06 05-05 MAZDA TRIBUTE 05-06		FORD ESCAPE AUTOMÁTICA 05-08 MAZDA TRIBUTE 05-06		ACURA TL 3.2 6 V 07-08 TL 3.5 6 V 07-08	
No. Lusac: 390918 Producto: CILINDRO MAESTRO 		No. Lusac: 390919 Producto: CILINDRO MAESTRO 		No. Lusac: 390922 Producto: CILINDRO MAESTRO 	
DIAMETRO	1-1/16"	DIAMETRO	1"	DIAMETRO	1"
FORD ESCAPE AUTOMÁTICA 07-08		FORD FREESTAR C/C DE TRACCIÓN 06-07 FIVE HUNDRED C/C DE TRACCIÓN 05-07		MERCURY MONTEGO C/C DE TRACCIÓN 05-07 FORD ESCAPE MANUAL 07-08	



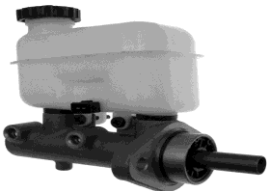



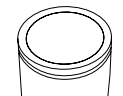

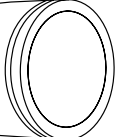







No. Lusac: 390923 Producto: CILINDRO MAESTRO		No. Lusac: 390924 Producto: CILINDRO MAESTRO		No. Lusac: 390925 Producto: CILINDRO MAESTRO	
					
DIAMETRO	7/8" 13/16"	DIAMETRO	1"	DIAMETRO	15/16"
BMW 323TI 99-00 323IA 98-01		SAAB 9-3 99-00 04-05 9-3 SEDAN 01-03 9-3 CONVERTIBLE 04-04		AUDI A3 02-03 JETTA A4 EUROPA 05 JETTA A4 TRENDLINE 05 VOLKSWAGEN BEETLE GL, GLS, GLX, CABRIOLET BEETLE GL, GLS, GLX, CABRIOLET TURBO 98-00 TURBO 04-05 JETTA CLASICO 11-14 GOLF A4 1.9 04 BEETLE GL, GLS, GLX, CABRIOLET BEETLE GL, GLS, GLX, CABRIOLET 2 4 L OHC TURBO 09-10 TURBO 03-04 JETTA A4 09-10 NEW BEETLE 02-10 BEETLE GL, GLS, GLX, CABRIOLET BEETLE GLS GLX 02-04 2 4 L OHC TURBO 08-09 JETTA A4 BASE, EUROPA, TDI, JETTA A4 EUROPA 02-04 TRENDLINE DIESEL 08 JETTA A4 TDI DIESEL 08 JETTA A4 TRENDLINE 02-04 BEETLE GL, GLS, GLX, CABRIOLET BEETLE GL, GLS, GLX, CABRIOLET 2 4 L OHC TURBO 07-08 TURBO 02-03 JETTA A4 BASE, EUROPA, TDI, GOLF A4 02-03 TRENDLINE DIESEL 07 BEETLE CABRIOLET, GLX SPORT BEETLE GL, GLS, GLX, CABRIOLET 2.5 5 L 06-10 TURBO 02 JETTA A4 EUROPA 06-10 BEETLE GLS GLX TURBO 01-03 JETTA A4 TRENDLINE 06-08 BEETLE GL, GLS, GLX, CABRIOLET TURBO 01-02 BEETLE GL, GLS, GLX, CABRIOLET JETTA A4 ESP 00-05 2 4 L OHC TURBO 06-07 JETTA A4 BASE, EUROPA, TDI, BEETLE GL, GLS, GLX, CABRIOLET TRENDLINE DIESEL 06-07 TURBO 00-01 BEETLE CABRIOLET, GLX SPORT BEETLE GLS GLX TURBO 00-01 2.5 5 L DOHC 06 BEETLE GL, GLS, GLX, CABRIOLET GOLF A4 00-01 2 4 L OHC TURBO 06 JETTA A4 BASE, EUROPA, TDI, BEETLE GL, GLS, GLX, CABRIOLET TRENDLINE DIESEL 06-06 TURBO 00 GOLF A4 05-07 BEETLE GLS GLX TURBO 00 BEETLE GL, GLS, GLX, CABRIOLET TURBO 05 BEETLE GLS GLX TURBO 05	
No. Lusac: 390926 Producto: CILINDRO MAESTRO		No. Lusac: 390927 Producto: CILINDRO MAESTRO		No. Lusac: 390930 Producto: CILINDRO MAESTRO	
					
DIAMETRO	1-1/8"	DIAMETRO	1-1/8"	DIAMETRO	1-1/8"
DODGE DAKOTA LARAMIE C/ABS 07-10 DAKOTA 05-08		DODGE DAKOTA 11-11 DAKOTA LARAMIE C/ABS 07-10		CHEVROLET SILVERADO 1500 4X2 05-06 SIERRA 1500 CLASSIC SLE 07-07 SILVERADO 1500 4X4 05-06 SIERRA 1500 CLASSIC SLT 07-07 GMC SIERRA 1500 CLASSIC SL 07-07	









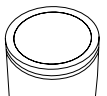

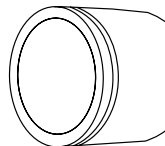





Fotografías de producto y especificaciones

No. Lusac: 390931 Producto: CILINDRO MAESTRO 		No. Lusac: 390933 Producto: CILINDRO MAESTRO 		No. Lusac: 390947 Producto: CILINDRO MAESTRO 	
DIAMETRO	22.2 mm 7/8"	DIAMETRO	15/16"	DIAMETRO	1"
VOLKSWAGEN GOLF A3 CL, A3 GL 1.8 4 L 98-98 CABRIO A3 2 4 L 97-99 PASSAT 2.8 6 VR S/ABS 96-97 PASSAT VAGONETA 96-97 GOLF A3 CL, A3 GL 94-94 93-94 GOLF A3 GTI S/ABS 93-94		CHEVROLET MALIBU 08-08 PONTIAC G6 05-07		SATURN AURA 07-08 NISSAN XTERRA 00-02	
No. Lusac: 390956 Producto: CILINDRO MAESTRO 		No. Lusac: 390957 Producto: CILINDRO MAESTRO 		No. Lusac: 390958 Producto: CILINDRO MAESTRO 	
DIAMETRO	1-1/2"	DIAMETRO	1-5/16"	DIAMETRO	26.9 mm 1-1/16"
FORD F550 C/C DE VELOCIDAD 05-07		FORD F250 SUPER DUTY, XL, XLT 07-07 07-07 F450 S/C DE VELOCIDAD 05-08		FORD MUSTANG GT, SHELBY GT500 C/ABS 07-14 MUSTANG CONVERTIBLE C/ABS 06-08 MUSTANG GT, SHELBY GT500 C/ABS 05-07	
No. Lusac: 390960 Producto: CILINDRO MAESTRO 		No. Lusac: 390961 Producto: CILINDRO MAESTRO 		No. Lusac: 390964 Producto: CILINDRO MAESTRO 	
DIAMETRO	1"	DIAMETRO	1-1/4"	DIAMETRO	13/16"
FORD FREESTAR S/C DE TRACCIÓN 06-07 FIVE HUNDRED S/C DE TRACCIÓN 05-07		MERCURY MONTEGO S/C DE TRACCIÓN 05-07 FORD F250 4X2 S/C DE VELOCIDAD 96-97		TOYOTA TACOMA 4X2 05-08 TACOMA PRE RUNNER 05	
No. Lusac: 390965 Producto: CILINDRO MAESTRO 		No. Lusac: 390966 Producto: CILINDRO MAESTRO 		No. Lusac: 390967 Producto: CILINDRO MAESTRO 	
DIAMETRO	13/16"	DIAMETRO	7/8"	DIAMETRO	7/8"
TOYOTA TACOMA 4X4 06-08		TOYOTA CAMRY LE MANUAL 05-06		TOYOTA CAMRY LE S/C DE ESTABILIDAD 09-09 CAMRY LE, SE MANUAL 09 CAMRY LE, BASE MANUAL 09	







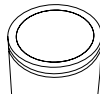

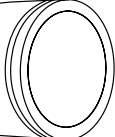



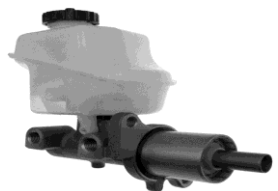

<p>No. Lusac: 390968 Producto: CILINDRO MAESTRO</p> 		<p>No. Lusac: 390969 Producto: CILINDRO MAESTRO</p> 		<p>No. Lusac: 390970 Producto: CILINDRO MAESTRO</p> 	
DIAMETRO	7/8"	DIAMETRO	7/8"	DIAMETRO	22.2 mm 7/8"
<p>TOYOTA</p> <p>CAMRY LE, BASE MANUAL 11-11 CAMRY LE, BASE MANUAL 09-10 CAMRY LE 10-11 CAMRY LE MANUAL 09 CAMRY LE, BASE MANUAL 10-11 CAMRY LE, XLE 07-08 CAMRY LE, SE MANUAL 09-11</p>		<p>TOYOTA</p> <p>CAMRY AUTOMÁTICO 09 CAMRY XLE AUTOMÁTICO S/C DE ESTABILIDAD 09-09 CAMRY LE AUTOMÁTICO 09 CAMRY SE AUTOMÁTICO 09</p>		<p>TOYOTA</p> <p>CAMRY LE 09-11 CAMRY LE, XLE 08-08 07-08 07-07 CAMRY XLE 09-11</p>	
<p>No. Lusac: 390971 Producto: CILINDRO MAESTRO</p> 		<p>No. Lusac: 390975 Producto: CILINDRO MAESTRO</p> 		<p>No. Lusac: 390976 Producto: CILINDRO MAESTRO</p> 	
DIAMETRO	7/8"	DIAMETRO	15/16"	DIAMETRO	1-1/4"
<p>TOYOTA</p> <p>CAMRY 09-11 CAMRY XLE 09-11 CAMRY LE 09-11 CAMRY LE, XLE 08-08 07-08 07-07 CAMRY SE 09-11</p>		<p>CHRYSLER DODGE</p> <p>TOWN & COUNTRY C/ABS 05-07 CARAVAN C/ABS 06-07</p>		<p>DODGE</p> <p>RAM 1500 SLT 06-06</p>	
<p>No. Lusac: 390977 Producto: CILINDRO MAESTRO</p> 		<p>No. Lusac: 390978 Producto: CILINDRO MAESTRO</p> 		<p>No. Lusac: 390979 Producto: CILINDRO MAESTRO</p> 	
DIAMETRO	1"	DIAMETRO	1"	DIAMETRO	1-1/16"
<p>CHRYSLER</p> <p>300 3.5 6 V OHC 07-07 300C 3.5 6 V OHC 05-05 300 2.7 6 V C/C DE TRACCIÓN 06-07 300C 05-07</p>		<p>CHRYSLER DODGE</p> <p>300 2.7 6 V S/C DE TRACCIÓN 06-07 CHARGER SXT S/C DE TRACCIÓN 06-07</p>		<p>MERCEDEZ BENZ</p> <p>SPRINTER 316 DIESEL 05-05</p>	
<p>No. Lusac: 390980 Producto: CILINDRO MAESTRO</p> 		<p>No. Lusac: 390981 Producto: CILINDRO MAESTRO</p> 		<p>No. Lusac: 390983 Producto: CILINDRO MAESTRO</p> 	
DIAMETRO	25.4 mm 1"	DIAMETRO	7/8"	DIAMETRO	1-1/16"
<p>MERCEDEZ BENZ</p> <p>SPRINTER 316 04-06 SPRINTER 3500 03-06 SPRINTER 416 04-06 SPRINTER 2500 03-06</p>		<p>CHEVROLET</p> <p>COBALT NATURAL MANUAL S/C ACTIVO DE FRENOS 05-08 PONTIAC G5 LS SEDAN 09</p>		<p>CHEVROLET</p> <p>G5 LS SEDAN MANUAL S/C ACTIVO DE FRENOS 07-08 G4 MANUAL 05-06</p>	
<p>CHEVROLET</p> <p>TRAILBLAZER 08-08 TRAILBLAZER LS, LT 4X2 07</p>					









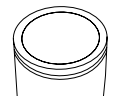

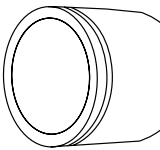



Fotografías de producto y especificaciones

No. Lusac: 390985 Producto: CILINDRO MAESTRO 		No. Lusac: 390986 Producto: CILINDRO MAESTRO 		No. Lusac: 390988 Producto: CILINDRO MAESTRO 	
DIAMETRO	7/8"	DIAMETRO	1-1/4"	DIAMETRO	26.9 mm 1-1/16"
CHEVROLET COBALT NATURAL AUTOMÁTICO 05-08 PONTIAC G6 AUTOMÁTICA 05-07 G4 AUTOMÁTICA 05-06 G5 LS SEDAN AUTOMÁTICA 09-09 G5 LS SEDAN AUTOMÁTICA S/C ACTIVO DE FRENOS 07-08		CADILLAC ESCALADE 07-08 CHEVROLET TAHOE 07-10 AVALANCHE 07-08 SILVERADO 1500 4X2 03-06 GMC YUKON 07-08		MERCEDEZ BENZ SPRINTER 2500 AUTOMÁTICA 11-11 SPRINTER 2500 10-10 SPRINTER 2500 MANUAL 09-09 SPRINTER 2500 08-08 SPRINTER 3500 07-11 SPRINTER 415 07-11 SPRINTER 515 07-11 SPRINTER 2500 MANUAL 07-07 SPRINTER 416 04-11	
No. Lusac: 390991 Producto: CILINDRO MAESTRO 		No. Lusac: 390994 Producto: CILINDRO MAESTRO 		No. Lusac: 390995 Producto: CILINDRO MAESTRO 	
DIAMETRO	1"	DIAMETRO	25.4 mm 1"	DIAMETRO	1"
CHRYSLER 300C 5.7 8 V 09-09 300 3.5 6 V OHC 07-07 300 06-07 300C 5.7 8 V 05-08		DODGE CHARGER SXT 3.5 6 V 06-07		NISSAN FRONTIER 4X4 01-01	
NISSAN FRONTIER SE, XE 4X2 AUTOMÁTICA 05-11 XTERRA 4X2 AUTOMÁTICA S/C DE ESTABILIDAD 05-05		HONDA CR-V 07-11		NISSAN FRONTIER 2.4 4X4 01-01	
No. Lusac: 390996 Producto: CILINDRO MAESTRO 		No. Lusac: 390997 Producto: CILINDRO MAESTRO 		No. Lusac: 390998 Producto: CILINDRO MAESTRO 	
DIAMETRO	1"	DIAMETRO	7/8"	DIAMETRO	1"
NISSAN FRONTIER SE, XE 4X2 AUTOMÁTICA 05-11 XTERRA 4X2 AUTOMÁTICA S/C DE ESTABILIDAD 05-05		HONDA CR-V 07-11		HONDA CR-V 05-06	
No. Lusac: 391000 Producto: CILINDRO MAESTRO 		No. Lusac: 391001 Producto: CILINDRO MAESTRO 		No. Lusac: 391002 Producto: CILINDRO MAESTRO 	
DIAMETRO	7/8"	DIAMETRO	1-1/16"	DIAMETRO	3/4"
HONDA FIT 07-08		JEEP COMMANDER LIMITED PREMIUM 08-09 GRAND CHEROKEE 06-10 GRAND CHEROKEE SRT8 06-10		HONDA CIVIC SEDAN 07-13 CIVIC EX COUPE 06-10	







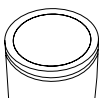

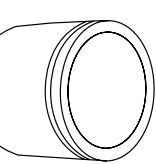







No. Lusac: 391004 Producto: CILINDRO MAESTRO 		No. Lusac: 391005 Producto: CILINDRO MAESTRO 		No. Lusac: 391006 Producto: CILINDRO MAESTRO 	
DIAMETRO	7/8"	DIAMETRO	13/16"	DIAMETRO	13/16"
ACURA ZDX 10-13 MDX 3.7 6 V 07-13		HONDA ODYSSEY 05-10		TOYOTA YARIS HATCH BACK HATCHBACK MANUAL 07-07 YARIS HATCHBACK MANUAL 06-07 YARIS HATCHBACK AUTOMÁTICA 07-07 YARIS HATCHBACK AUTOMÁTICA 06-07 YARIS SEDAN AUTOMÁTICA 06-11	
No. Lusac: 391007 Producto: CILINDRO MAESTRO 		No. Lusac: 391008 Producto: CILINDRO MAESTRO 		No. Lusac: 391010 Producto: CILINDRO MAESTRO 	
DIAMETRO	1-1/16"	DIAMETRO	1.00"	DIAMETRO	1"
ACURA MDX 3.5 6 V 05-06 MDX 03-04		HONDA RIDGELINE 06-08 PILOT 03-08		NISSAN FRONTIER SE MANUAL S/C DE TRACCIÓN 05-11	
				BUICK TERRAZA 05-07	
				PONTIAC MONTANA SV6 05-09 MONTANA SV6 05-09	
				CHEVROLET UPLANDER LS 3.9 6 V OHV 4X2 EXT 06-09 UPLANDER LT 3.9 6 V OHV 4X2 EXT 05-09 UPLANDER LS 3.5 6 V OHV 4X2 EXT 05-06 UPLANDER LT 3.5 6 V OHV 4X2 EXT 05-06	
				SATURN RELAY 05-07	
No. Lusac: 391012 Producto: CILINDRO MAESTRO 		No. Lusac: 391013 Producto: CILINDRO MAESTRO 		No. Lusac: 391014 Producto: CILINDRO MAESTRO 	
DIAMETRO	26.9 mm 1-1/16"	DIAMETRO	22.2 mm 7/8"	DIAMETRO	25.4 mm 1"
JEEP LIBERTY 06-07		MITSUBISHI LANCER ES 04-07		MITSUBISHI GALANT ES 3.8 6 V OHC 09-09 GALANT RALLIART 3.8 6 V OHC 07-08 GALANT ES 3.8 6 V OHC 07-07	
				GALANT GTS 3.8 6 V OHC 05-07 GALANT ES 2.4 C/ABS 04-04	
No. Lusac: 391020 Producto: CILINDRO MAESTRO 		No. Lusac: 391021 Producto: CILINDRO MAESTRO 		No. Lusac: 391022 Producto: CILINDRO MAESTRO 	
DIAMETRO	1-1/16"	DIAMETRO	1"	DIAMETRO	7/8"
JEEP GRAND CHEROKEE C/C DE TRACCIÓN 05-05		CADILLAC XLR ROADSTER 04-06		CHEVROLET CORVETTE 05-08	
				DODGE ATTITUDE GL, GLS S/ABS 06-11	









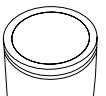

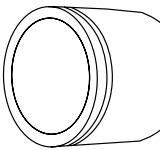



Fotografías de producto y especificaciones

No. Lusac: 391024 Producto: CILINDRO MAESTRO		No. Lusac: 391026 Producto: CILINDRO MAESTRO		No. Lusac: 391030 Producto: CILINDRO MAESTRO	
					
DIAMETRO	7/8"	DIAMETRO	37mm	DIAMETRO	15/16"
DODGE ATTITUDE GL, GLS C/ABS 06-11		CHEVROLET EXPRESS 3500 04-08 EXPRESS 3500 EXT 04-08 EXPRESS 3500 CARGO VAN 03-03		GMC SAVANA 3500 04-07 SAVANA 3500 EXT 04-07	
No. Lusac: 391031 Producto: CILINDRO MAESTRO		No. Lusac: 391032 Producto: CILINDRO MAESTRO		No. Lusac: 391033 Producto: CILINDRO MAESTRO	
					
DIAMETRO	7/8"	DIAMETRO	22.2 mm 7/8"	DIAMETRO	1-5/16"
CHRYSLER PT CRUISER 06-10 PT CRUISER CONVERTIBLE 06-08 PT CRUISER TURBO 06-07		CHRYSLER PT CRUISER 05-10 PT CRUISER S/ABS 05-05		DODGE RAM 2500 DIESEL 11-11 RAM 2500 HD DIESEL 08-10	
No. Lusac: 391036 Producto: CILINDRO MAESTRO		No. Lusac: 391037 Producto: CILINDRO MAESTRO		No. Lusac: 391041 Producto: CILINDRO MAESTRO	
					
DIAMETRO	27mm	DIAMETRO	1"	DIAMETRO	1-1/16"
VOLKSWAGEN TOUAREG 2 10-10 TOUAREG 04-09		AUDI A4 C/CILINDRO ATE 06-09 A4 QUATTRO C/CILINDRO ATE 02-09 A6 C/CILINDRO ATE 02-04 A6 QUATTRO C/CILINDRO ATE 02-04 S6 QUATTRO C/CILINDRO ATE 01-04 A4 C/CILINDRO ATE 01-01		FORD F150 C/C DE VELOCIDAD 00-01	
No. Lusac: 391042 Producto: CILINDRO MAESTRO		No. Lusac: 391043 Producto: CILINDRO MAESTRO		No. Lusac: 391045 Producto: CILINDRO MAESTRO	
					
DIAMETRO	1-1/2"	DIAMETRO	1-5/16"	DIAMETRO	1-1/16"
FORD F550 05-07		FORD F250 SUPER DUTY, XL, XLT 07-07 F450 C/C DE VELOCIDAD 05-07 F550 C/C DE VELOCIDAD 05-07		FORD EXPLORER 02-05 MERCURY MOUNTAINEER 03-05 LINCOLN AVIATOR C/C DE TRACCIÓN 03-05	







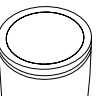

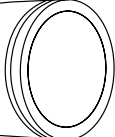



No. Lusac: 391049 Producto: CILINDRO MAESTRO 		No. Lusac: 391065 Producto: CILINDRO MAESTRO 		No. Lusac: 391066 Producto: CILINDRO MAESTRO 	
DIAMETRO	1"	DIAMETRO	23.8 mm 15/16"	DIAMETRO	13/16"
MAZDA MAZDA3 06-14		PONTIAC SOLSTICE 06-09		DODGE CALIBER 2.4 L DOHC C/ABS 07-12 CALIBER C/ABS 07-12 CALIBER 1.8 4 L C/ABS 07-11	
				JEEP PATRIOT SPORT, LIMITED 14-14 13-14 12-13 11-12 10-11 09-10 08-09 COMPASS SPORT, LIMITED PREMIUM 07-14 PATRIOT SPORT, LIMITED 07-08 07-07	
No. Lusac: 391068 Producto: CILINDRO MAESTRO 		No. Lusac: 391069 Producto: CILINDRO MAESTRO 		No. Lusac: 391071 Producto: CILINDRO MAESTRO 	
DIAMETRO	25.4 mm 1"	DIAMETRO	13/16"	DIAMETRO	20.6 mm 13/16"
JEEP WRANGLER SAHARA DISCO 07-14 WRANGLER UNLIMITED RUBICON 07-14		FORD FUSION SE C/ABS 08-09 FUSION SE, PREMIUM C/ABS 06-07 LINCOLN MKZ 07-08 ZEPHYR 06-06		MAZDA MAZDA6 C/ABS 06-08 MERCURY MILAN S/C DE ESTABILIDAD 09-09 MILAN 07-08 MILAN C/ABS 06-06	
				DODGE CALIBER S/ABS 07-12	
No. Lusac: 391072 Producto: CILINDRO MAESTRO 		No. Lusac: 391080 Producto: CILINDRO MAESTRO 		No. Lusac: 391081 Producto: CILINDRO MAESTRO 	
DIAMETRO	1-3/16"	DIAMETRO	28.5 mm 1-1/8"	DIAMETRO	37mm
INFINITI QX56 04-10 NISSAN ARMADA 4X4 11-13		CHEVROLET SILVERADO 1500 07-07		GMC SIERRA 1500 07-07	
TITAN 04-12 ARMADA 04-10				CHEVROLET EXPRESS 2500 08 EXPRESS 2500 EXT 08 EXPRESS 3500 08 EXPRESS 3500 EXT 08 SILVERADO 2500HD 07-08 SILVERADO 3500 07-08	
				GMC SAVANA 2500 08 SAVANA 3500 08 SIERRA 2500HD 07-08 SIERRA 3500HD 07-08	









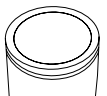

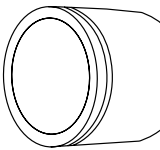



Fotografías de producto y especificaciones

No. Lusac: 391082 Producto: CILINDRO MAESTRO 		No. Lusac: 391085 Producto: CILINDRO MAESTRO 		No. Lusac: 391092 Producto: CILINDRO MAESTRO 	
DIAMETRO	37mm	DIAMETRO	15/16"	DIAMETRO	15/16"
CHEVROLET EXPRESS 2500 EXT 08 EXPRESS 2500 08-08 EXPRESS 3500 EXT 08-08 EXPRESS 3500 08-08 SILVERADO 2500HD 07-08 SILVERADO 3500 07-08		GMC SAVANA 2500 08 SAVANA 3500 08-08 SIERRA 2500HD 07-08 SIERRA 3500HD 07-08 YUKON 1500 XL 07-08		TOYOTA SEQUOIA 08-14 TUNDRA 07-13	
VOLKSWAGEN JETTA CLASICO 11-14 BEETLE GL, GLS, GLX, CABRIOLET 2 4 L OHC TURBO 09-10 JETTA A4 EUROPA 09-10 JETTA A4 09-10 BEETLE GL, GLS, GLX, CABRIOLET 2 4 L OHC TURBO 09 BEETLE CABRIOLET, GLX SPORT 08-10 BEETLE GL, GLS, GLX, CABRIOLET 2 4 L OHC TURBO 08-09 JETTA A4 08-08 BEETLE CABRIOLET, GLX SPORT 07-08 BEETLE GL, GLS, GLX, CABRIOLET 2 4 L 07-08 BEETLE CABRIOLET, GLX SPORT 06-07 BEETLE GL, GLS, GLX, CABRIOLET 06-07		BEETLE CABRIOLET, GLX 06 BEETLE GL, GLS, GLX, CABRIOLET 2 4 L OHC TURBO 06 BEETLE GL, GLS, GLX, CABRIOLET TURBO 05-05 05-05 BEETLE GLS GLX TURBO 05-05 BEETLE GL, GLS, GLX, CABRIOLET 2 4 L OHC TURBO 09 BEETLE GL, GLS, GLX, CABRIOLET TURBO 03-03 NEW BEETLE 02-10 BEETLE GL, GLS, GLX, CABRIOLET 02-04 BEETLE GLS GLX CON FRENOS ATE 02-04 BEETLE GL, GLS, GLX, CABRIOLET 2 4 L 07-08 BEETLE GLS GLX TURBO 02-03 BEETLE GLS GLX TURBO 02-03			
No. Lusac: 391096 Producto: CILINDRO MAESTRO 		No. Lusac: 391097 Producto: CILINDRO MAESTRO 		No. Lusac: 391098 Producto: CILINDRO MAESTRO 	
DIAMETRO	1"	DIAMETRO	1"	DIAMETRO	1"
NISSAN PATHFINDER 10-12 FRONTIER SE AUTOMÁTICA 08-11 PATHFINDER 6 V 08-09		NISSAN PATHFINDER 05-07 XTERRA AUTOMÁTICA 05-07 FRONTIER SE 4X2 07-07		NISSAN FRONTIER SE 4X4 07-07 XTERRA ATM 05-07 PATHFINDER 05-09	
No. Lusac: 391099 Producto: CILINDRO MAESTRO 		No. Lusac: 391100 Producto: CILINDRO MAESTRO 		No. Lusac: 391101 Producto: CILINDRO MAESTRO 	
DIAMETRO	25.4 mm 1"	DIAMETRO	7/8"	DIAMETRO	13/16"
NISSAN FRONTIER MANUAL 12-13		HONDA PILOT 09-14		ACURA TSX 09-14 HONDA ACCORD 3.5 6 V OHC 09-12 ACCORD 08-12	





<p>No. Lusac: 391110</p> <p>Producto: CILINDRO MAESTRO</p> 		<p>No. Lusac: 391121</p> <p>Producto: CILINDRO MAESTRO</p> 		<p>No. Lusac: 391122</p> <p>Producto: CILINDRO MAESTRO</p> 	
DIAMETRO	1-3/16"	DIAMETRO	1-1/4"	DIAMETRO	1-1/4"
<p>DODGE</p> <p>DURANGO SLT, LIMITED S/C DE ESTABILIDAD 07-09 DURANGO 06-06</p>		<p>DODGE</p> <p>RAM 1500 PROMASTER 14 RAM 1500 4X2 07-08 RAM 2500 4X2 11-12 RAM 1500 4X4 07-08 RAM 4000 11-11 RAM 1500 ST 09-13</p>		<p>CHRYSLER</p> <p>ASPEN 07-09 DURANGO 06-06</p> <p>DODGE</p> <p>DURANGO SLT, LIMITED 07-09</p>	
<p>No. Lusac: 391123</p> <p>Producto: CILINDRO MAESTRO</p> 		<p>No. Lusac: 391124</p> <p>Producto: CILINDRO MAESTRO</p> 		<p>No. Lusac: 391125</p> <p>Producto: CILINDRO MAESTRO</p> 	
DIAMETRO	25.4 mm 1"	DIAMETRO	1 1/16"	DIAMETRO	1"
<p>DODGE</p> <p>NITRO 07-12</p>		<p>JEEP</p> <p>LIBERTY 07-11</p>		<p>DODGE</p> <p>NITRO 07-10</p>	
<p>CHRYSLER</p> <p>300C 5.7 8 V 08-09 300 08-08</p>		<p>DODGE</p> <p>CHARGER RT DAYTONA 3.5 6 V 08-10</p>			
<p>No. Lusac: 391126</p> <p>Producto: CILINDRO MAESTRO</p> 		<p>No. Lusac: 391127</p> <p>Producto: CILINDRO MAESTRO</p> 		<p>No. Lusac: 391129</p> <p>Producto: CILINDRO MAESTRO</p> 	
DIAMETRO	1-1/16"	DIAMETRO	1"	DIAMETRO	13/16"
<p>CHRYSLER</p> <p>300C SRT-8 6.1 8 V OHC 06-08</p>		<p>DODGE</p> <p>CHARGER SRT8 6.1 8 V 07-08</p>		<p>CHRYSLER</p> <p>300C 5.7 8 V 10-10 300 09-10</p>	
<p>FORD</p> <p>FUSION SE S/ABS 08-09 FUSION SE, PREMIUM S/ABS 06-07</p>		<p>MAZDA</p> <p>MAZDA6 S/ABS 06-08</p>		<p>MERCURY</p> <p>MILAN S/ABS 06-06</p>	

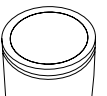

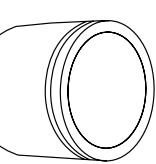





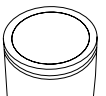

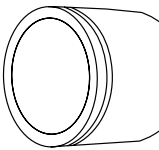





Fotografías de producto y especificaciones

No. Lusac: 391130 Producto: CILINDRO MAESTRO		No. Lusac: 391133 Producto: CILINDRO MAESTRO		No. Lusac: 391134 Producto: CILINDRO MAESTRO	
DIAMETRO	25.4 mm 1"	DIAMETRO	1-1/16"	DIAMETRO	13/16"
VOLKSWAGEN EUROVAN C/ABS 00-03		FORD EXPLORER SPORT TRAC 4X2 07-08 EXPLORER EDDIE BAUER 06-10		MERCURY MOUNTAINEER 09-10	
				FORD FUSION 09-09 LINCOLN MKZ 09-10	
No. Lusac: 391137 Producto: CILINDRO MAESTRO		No. Lusac: 391138 Producto: CILINDRO MAESTRO		No. Lusac: 391139 Producto: CILINDRO MAESTRO	
DIAMETRO	23.8 mm 15/16"	DIAMETRO	7/8"	DIAMETRO	27.0 mm
FORD FOCUS 09-11		TOYOTA SIENNA 11-14 HIGHLANDER 08-13		FORD RANGER 07-09	
No. Lusac: 391142 Producto: CILINDRO MAESTRO		No. Lusac: 391143 Producto: CILINDRO MAESTRO		No. Lusac: 391144 Producto: CILINDRO MAESTRO	
DIAMETRO	7/8"	DIAMETRO	15/16"	DIAMETRO	7/8"
CHRYSLER SEBRING 07-09 DODGE AVENGER SE, SXT SPORT 09-11		DODGE CALIBER SRT4 2.4 4 L DOHC 08-09		CHRYSLER 200 11-14 SEBRING 07-10	
AVENGER SE, SXT SPORT 08-09				DODGE AVENGER SE, SXT SPORT 08-14	
No. Lusac: 391145 Producto: CILINDRO MAESTRO		No. Lusac: 391146 Producto: CILINDRO MAESTRO		No. Lusac: 391147 Producto: CILINDRO MAESTRO	
DIAMETRO	1"	DIAMETRO	22.2 mm 7/8"	DIAMETRO	1-1/16"
CHEVROLET CAPTIVA SPORT 08-13 EQUINOX 07-08		PONTIAC TORRENT 07-09		CHEVROLET AVEO S/ABS 08-08	
				BUICK ENCLAVE 08-14 CHEVROLET TRAVERSE 09-14	
				GMC ACADIA 07-14	







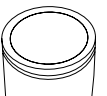

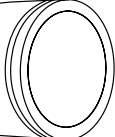



No. Lusac: 391150 Producto: CILINDRO MAESTRO		No. Lusac: 391154 Producto: CILINDRO MAESTRO		No. Lusac: 391155 Producto: CILINDRO MAESTRO	
					
DIAMETRO	28.5 mm 1-1/8"	DIAMETRO	1"	DIAMETRO	15/16"
FORD F150 09-09		BUICK REGAL BASE 12-13 VERANO 12-13 LACROSSE 10-13		CHEVROLET CRUZE 10-14 SAAB 9-5 10-11	
No. Lusac: 391156 Producto: CILINDRO MAESTRO		No. Lusac: 391157 Producto: CILINDRO MAESTRO		No. Lusac: 391158 Producto: CILINDRO MAESTRO	
					
DIAMETRO	15/16"	DIAMETRO	23.8 mm 15/16"	DIAMETRO	1"
NISSAN TIIDA HATCHBACK 10-12 TIIDA SEDAN 10-12		FORD FOCUS 09-11		NISSAN QUEST 11-14 MURANO 09-14	
No. Lusac: 391161 Producto: CILINDRO MAESTRO		No. Lusac: 391162 Producto: CILINDRO MAESTRO		No. Lusac: 391163 Producto: CILINDRO MAESTRO	
					
DIAMETRO	33.3 mm 1-5/16"	DIAMETRO	22.2 mm 7/8"	DIAMETRO	38.1 mm 1-1/2"
FORD F250 SUPER DUTY, XL, XLT 12 F350 SUPER DUTY, XL, XLT 12 F250 SUPER DUTY, XL, XLT 11-12 F350 SUPER DUTY, XL, XLT 11-12 F250 SUPER DUTY, XL, XLT 11 F350 SUPER DUTY, XL, XLT 08-11		FORD EDGE 07-14 LINCOLN MKX 07-14		FORD F350 SUPER DUTY, XL, XLT 12-14 F250 SUPER DUTY, XL, XLT 11-12 F350 SUPER DUTY, XL, XLT 11-12 F450 11-12 F250 SUPER DUTY, XL, XLT 11 F350 SUPER DUTY, XL, XLT 08-11	
No. Lusac: 391164 Producto: CILINDRO MAESTRO		No. Lusac: 391165 Producto: CILINDRO MAESTRO		No. Lusac: 391168 Producto: CILINDRO MAESTRO	
					
DIAMETRO	30.1 mm 1-3/16"	DIAMETRO	15/16"	DIAMETRO	38.1 mm 1-1/2"
FORD F150 XL 10-14 LOBO 10-14		LINCOLN NAVIGATOR 11-14		CHEVROLET HHR AUTOMÁTICO 10-11 HHR 08-09 HHR 06-07	
				CHEVROLET EXPRESS 3500 VAN 11-13 EXPRESS CUTAWAY 11-12 EXPRESS 2500 CARGO VAN 09-13 SILVERADO 2500 4X4 09-12 SUBURBAN 2500 09-10 SILVERADO 2500 4X2 09-12	









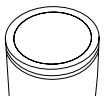

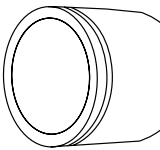



Fotografías de producto y especificaciones

No. Lusac: 391169 Producto: CILINDRO MAESTRO 		No. Lusac: 391170 Producto: CILINDRO MAESTRO 		No. Lusac: 391171 Producto: CILINDRO MAESTRO 	
DIAMETRO	1-1/8"	DIAMETRO	7/8"	DIAMETRO	1"
CHEVROLET SILVERADO 1500 4X2 14 SILVERADO 1500 4X4 14		CHEVROLET PONTIAC AVEO 08-11 G3 S/ABS 09-10		CHEVROLET ASTRA 08-09	
No. Lusac: 391172 Producto: CILINDRO MAESTRO 		No. Lusac: 391173 Producto: CILINDRO MAESTRO 		No. Lusac: 391175 Producto: CILINDRO MAESTRO 	
DIAMETRO	1-1/4"	DIAMETRO	7/8"	DIAMETRO	7/8"
CADILLAC ESCALADE ESV 14-14 SUBURBAN 1500 09-13 ESCALADE 09-14 TAHOE 07-14		TOYOTA MATRIX 2.4 L DOHC 11-13 COROLLA 09-09 MATRIX XR 2.4 09-10		CHEVROLET COBALT 2.2 4 L AUTOMÁTICO 09-10 G5 GT SEDAN AUTOMÁTICA C/C ACTIVO DE FRENOS 09-09 PONTIAC G5 GT COUPE AUTOMÁTICA 09	
CHEVROLET SILVERADO 1500 4X2 14 YUKON 09-14 SILVERADO 1500 4X4 14 AVALANCHE 5.3 8 V 4X4 09-13					
No. Lusac: 391176 Producto: CILINDRO MAESTRO 		No. Lusac: 391177 Producto: CILINDRO MAESTRO 		No. Lusac: 391178 Producto: CILINDRO MAESTRO 	
DIAMETRO	7/8"	DIAMETRO	7/8"	DIAMETRO	7/8"
CHEVROLET COBALT 2.2 4 L AUTOMÁTICO S/C DE ESTABILIDAD 09-10 G5 GT SEDAN MANUAL 09 PONTIAC G5 GT COUPE MANUAL 09		CHEVROLET COBALT 2.2 4 L MANUAL 09-10 G5 GT SEDAN AUTOMÁTICA C/ABS 09-09 PONTIAC G5 GT COUPE AUTOMÁTICA C/ABS 09		CHEVROLET COBALT 2.2 4 L 09-10 G5 GT SEDAN MANUAL 09 PONTIAC G5 GT COUPE MANUAL 09	





No. Lusac: 391179 Producto: CILINDRO MAESTRO		No. Lusac: 391180 Producto: CILINDRO MAESTRO		No. Lusac: 391181 Producto: CILINDRO MAESTRO	
					
DIAMETRO	34mm	DIAMETRO	37.0 mm	DIAMETRO	26.9 mm 1-1/16"
CHEVROLET EXPRESS 1500 08-08		CHEVROLET EXPRESS 2500 CARGO VAN 07-08 SUBURBAN 2500 07-08 EXPRESS 3500 VAN 07-08		CHEVROLET GMC COLORADO 4X2 09-12 CANYON 4X2 09-12 COLORADO 4X4 09-12 CANYON 4X4 09-12	
No. Lusac: 391182 Producto: CILINDRO MAESTRO		No. Lusac: 391183 Producto: CILINDRO MAESTRO		No. Lusac: 391184 Producto: CILINDRO MAESTRO	
					
DIAMETRO	1"	DIAMETRO	1-1/2"	DIAMETRO	1-1/2"
CHEVROLET SUBURBAN 2500 07-08		CHEVROLET GMC SILVERADO 2500 4X2 S/C ACTIVO DE FRENOS 09-12 SIERRA 2500HD S/C ACTIVO DE FRENOS 10-10 SILVERADO 2500 4X4 S/C ACTIVO DE FRENOS 09-12 SIERRA 2500HD S/C ACTIVO DE FRENOS 09-09 SUBURBAN 2500 09-10		CHEVROLET EXPRESS 2500 EXT C/C ACTIVO DE FRENOS 14 EXPRESS 2500 CARGO VAN 09-13 EXPRESS 3500 EXT C/C ACTIVO DE FRENOS 14 SILVERADO 2500 4X2 09-12 SILVERADO 2500 4X4 13-14 EXPRESS 3500 VAN 09-10 EXPRESS 3500 VAN 11-13 GMC SUBURBAN 2500 11-13 SAVANA 2500 EXT C/C ACTIVO DE FRENOS 09-14 EXPRESS CUTAWAY 11-12 SIERRA 2500HD 09-13 SILVERADO 2500 4X2 09-14	
No. Lusac: 391185 Producto: CILINDRO MAESTRO		No. Lusac: 391186 Producto: CILINDRO MAESTRO		No. Lusac: 391187 Producto: CILINDRO MAESTRO	
					
DIAMETRO	15/16"	DIAMETRO	15/16"	DIAMETRO	15/16"
PONTIAC G6 08		CHEVROLET PONTIAC MALIBU 12-12 G6 09-09 MALIBU LX, LS 3.5 6 V 06-11		CHEVROLET PONTIAC COBALT 2.4 L 09-10 G5 09-09 COBALT TURBO/INTERCOOLER 08	

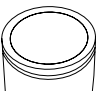

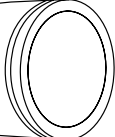





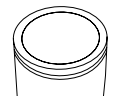

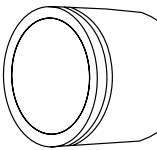





Fotografías de producto y especificaciones

No. Lusac: 391188 Producto: CILINDRO MAESTRO 		No. Lusac: 391189 Producto: CILINDRO MAESTRO 		No. Lusac: 391190 Producto: CILINDRO MAESTRO 	
DIAMETRO	1-5/16"	DIAMETRO	26.9 mm 1-1/16"	DIAMETRO	13/16" & 21/32"
FORD F450 C/C DE VELOCIDAD 08-10 F550 C/C DE VELOCIDAD 08-10		FORD MUSTANG CONVERTIBLE C/ABS 09-10		CADILLAC ESCALADE ESV 14 SILVERADO 1500 4X4 14 ESCALADE 09-13 SILVERADO 1500 4X2 14 CHEVROLET SILVERADO 1500 4X2 14	
No. Lusac: 391192 Producto: CILINDRO MAESTRO 		No. Lusac: 391193 Producto: CILINDRO MAESTRO 		No. Lusac: 391194 Producto: CILINDRO MAESTRO 	
DIAMETRO	1-5/16"	DIAMETRO	33.3 mm 1-5/16"	DIAMETRO	33.3 mm 1-5/16"
FORD E150 ECONOLINE VAN 08-14		FORD E150 10-10 E350 ECONOLINE 5.4 4X2 09-14		FORD E150 10-10 E350 09-11 E350 ECONOLINE 6.8 4X2 10	
No. Lusac: 391195 Producto: CILINDRO MAESTRO 		No. Lusac: 391196 Producto: CILINDRO MAESTRO  <small>Imagen Disponible Próximamente</small>		No. Lusac: 391197 Producto: CILINDRO MAESTRO 	
DIAMETRO	1-5/16"	DIAMETRO	38,1 mm 1-1/2"	DIAMETRO	1-1/2"
FORD F250 SUPER DUTY, XL, XLT 10-11 F250 SUPER DUTY, XL, XLT 08 F350 SUPER DUTY 10-11 F350 SUPER DUTY KING RANCH 08 F350 SUPER DUTY KING RANCH 10-11 F350 SUPER DUTY XL 08 F350 SUPER DUTY XL 09-11 F350 SUPER DUTY XLT 08 F350 SUPER DUTY XLT 09-11 F350 SUPER DUTY XLT 08 F250 SUPER DUTY, XL, XLT 09-10 F350 SUPER DUTY XLT 07 F350 SUPER DUTY KING RANCH 09 F350 SUPER DUTY KING RANCH 06-07 F350 SUPER DUTY LARIANT 08-11 F350 SUPER DUTY XLT 06 F450 08-11 F350 SUPER DUTY 05-08 F550 08-10 F350 SUPER DUTY XL 05-07 F250 SUPER DUTY, XL, XLT 08-09 F350 SUPER DUTY LARIANT 05-06 F350 SUPER DUTY FX4 08-09 F350 SUPER DUTY KING RANCH 05 E150 CLUB WAGON 08 F350 SUPER DUTY XLT 05 E150 ECONOLINE 08		FORD F450 11-12 F550 11-12		FORD F250 SUPER DUTY, XL, XLT 11 F350 SUPER DUTY 09-11 F350 SUPER DUTY KING RANCH 10-11 F250 SUPER DUTY, XL, XLT 09-10 F350 SUPER DUTY LARIANT 10-11 F450 08-11 F350 SUPER DUTY XL 10-11 F550 08-10 F350 SUPER DUTY XLT 10-11 F250 SUPER DUTY, XL, XLT 08-09 F250 SUPER DUTY, XL, XLT 10	







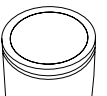

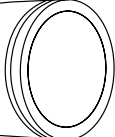







No. Lusac: 391198 Producto: CILINDRO MAESTRO		No. Lusac: 391199 Producto: CILINDRO MAESTRO		No. Lusac: 391200 Producto: CILINDRO MAESTRO	
					
DIAMETRO	1-3/8"	DIAMETRO	1-1/16"	DIAMETRO	1-1/2"
FORD F450 09-12 F250 SUPER DUTY, XL, XLT 09 F550 09-12 E350 SUPER DUTY 09		FORD MERCURY ESCAPE HIBRIDA 09-11 MARINER 09-10		FORD F250 08-10 F550 S/C DE VELOCIDAD 08-10 F350 08-10 F450 S/C DE VELOCIDAD 08-10	
No. Lusac: 391201 Producto: CILINDRO MAESTRO		No. Lusac: 391202 Producto: CILINDRO MAESTRO		No. Lusac: 391203 Producto: CILINDRO MAESTRO	
					
DIAMETRO	1-1/16"	DIAMETRO	26.9 mm 1-1/16"	DIAMETRO	1-1/16"
FORD ESCAPE SPORT XLS 07		FORD MERCURY ESCAPE SPORT 07-08 MARINER 09 ESCAPE XLS 07-08 MARINER 07-08 MAZDA TRIBUTE 08		FORD MERCURY ESCAPE AUTOMATICA 09-12 MARINER 08-11	
No. Lusac: 391204 Producto: CILINDRO MAESTRO		No. Lusac: 391205 Producto: CILINDRO MAESTRO		No. Lusac: 391206 Producto: CILINDRO MAESTRO	
					
DIAMETRO	26.9 mm 1-1/16"	DIAMETRO	4/8"	DIAMETRO	30.1 mm 1-3/16"
FORD MERCURY ESCAPE MANUAL 09-12 MARINER 08-11		LINCOLN MKS 09-14		FORD LINCOLN EXPEDITION XLT, EDDIE BAUER 07-09 NAVIGATOR 07-09	
No. Lusac: 391207 Producto: CILINDRO MAESTRO		No. Lusac: 391210 Producto: CILINDRO MAESTRO		No. Lusac: 391211 Producto: CILINDRO MAESTRO	
					
DIAMETRO	22.2 mm 7/8"	DIAMETRO	1-1/16"	DIAMETRO	1"
MAZDA MAZDA6 09-14		CHRYSLER 300 SRT-8 6.4 8 V 13-14 CHARGER SRT8 6.4 8 V 09-14 300C 5.7 8 V 12 CHALLENGER SRT8 6.1 8 V 08-10 300 11-12 CHARGER RT DAYTONA 3.5 6 V 08-10 DODGE CHALLENGER R/T 5.7 8 V 09-14		CHRYSLER DODGE TOWN & COUNTRY 10-14 GRAND CARAVAN 10-13 PACIFICA TOURING 07-08	











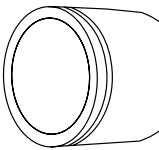





Fotografías de producto y especificaciones

No. Lusac: 391214 Producto: CILINDRO MAESTRO 		No. Lusac: 391215 Producto: CILINDRO MAESTRO 		No. Lusac: 391216 Producto: CILINDRO MAESTRO 	
DIAMETRO	22.2 mm 7/8"	DIAMETRO	15/16"	DIAMETRO	23.8 mm 15/16"
MAZDA CX-9 07-12		SUZUKI GRAND VITARA AUTOMÁTICA 06-11		SUZUKI GRAND VITARA MANUAL 06-11	
No. Lusac: 391218 Producto: CILINDRO MAESTRO 		No. Lusac: 391219 Producto: CILINDRO MAESTRO 		No. Lusac: 391220 Producto: CILINDRO MAESTRO 	
DIAMETRO	1-1/16"	DIAMETRO	20.6 mm 13/16"	DIAMETRO	1"
NISSAN 350Z 03-08		TOYOTA COROLLA S/C DE ESTABILIDAD 14 COROLLA 13 COROLLA 1.8 S/C DE ESTABILIDAD 10-12		MITSUBISHI ECLIPSE GT 10-12	
No. Lusac: 391221 Producto: CILINDRO MAESTRO 		No. Lusac: 391222 Producto: CILINDRO MAESTRO 		No. Lusac: 391223 Producto: CILINDRO MAESTRO 	
DIAMETRO	25.4 mm 1"	DIAMETRO	1"	DIAMETRO	13/16"
MITSUBISHI ECLIPSE 11-11		MITSUBISHI ENDEAVOR S/C DE TRACCIÓN 04-08		MITSUBISHI LANCER DE, ES C/ABS 14 LANCER EVO IX 14 LANCER DE, ES C/ABS 11-14 OUTLANDER 10-14 LANCER EVOLUTION IX 10-13 LANCER DE, ES C/ABS 08-11 LANCER EVO IX CVT 08-09 LANCER DE, ES C/ABS 08 LANCER S/ABS 07-10	
No. Lusac: 391224 Producto: CILINDRO MAESTRO 		No. Lusac: 391225 Producto: CILINDRO MAESTRO 		No. Lusac: 391227 Producto: CILINDRO MAESTRO 	
DIAMETRO	13/16"	DIAMETRO	1"	DIAMETRO	13/16"
MITSUBISHI LANCER EVO IX 10-14 LANCER DE, ES 08-09 LANCER EVOLUTION IX 08-09		HONDA RIDGELINE 09-14		HONDA CIVIC EX COUPE 09-10 CIVIC SEDAN 07-11	







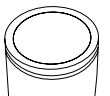

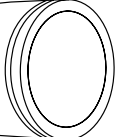







No. Lusac: 391228 Producto: CILINDRO MAESTRO		No. Lusac: 391231 Producto: CILINDRO MAESTRO		No. Lusac: 391232 Producto: CILINDRO MAESTRO	
					
DIAMETRO	3/4"	DIAMETRO	7/8"	DIAMETRO	7/8"
HONDA FIT 09-11		AUDI A3 04-13 EOS C/CILINDRO ATE 10 VOLKSWAGEN GOLF A5 GTI C/ABS S/C DE ESTABILIDAD 12-13 EOS 11-13 GOLF A5 GTI 11-11		VOLKSWAGEN NEW BEETLE 12-13 JETTA A6 11-13 BEETLE CABRIOLET, GLX SPORT 2.5 5 L DOHC 11 BORA 08-10 BORA TDI 1.9 4 L TURBO DIESEL C/CILINDRO FTE 07-10 BORA 06-08	
No. Lusac: 391233 Producto: CILINDRO MAESTRO		No. Lusac: 391235 Producto: CILINDRO MAESTRO		No. Lusac: 391236 Producto: CILINDRO MAESTRO	
					
DIAMETRO	7/8"	DIAMETRO	1"	DIAMETRO	33.3 mm 1-5/16"
VOLKSWAGEN PASSAT 2 4 L DOHC 09 PASSAT 3.6 6 V DOHC 08-10 PASSAT 3.6 6 V DOHC 4MOTION 06-08 PASSAT 4MOTION 06-07		GMC TERRAIN 10-14		FORD E350 08-08	
No. Lusac: 391237 Producto: CILINDRO MAESTRO		No. Lusac: 391238 Producto: CILINDRO MAESTRO		No. Lusac: 391246 Producto: CILINDRO MAESTRO	
 Imagen Disponible Próximamente					
DIAMETRO	7/8"	DIAMETRO	20.6 mm 13/16"	DIAMETRO	26.9 mm 1-1/16"
FORD FUSION S. SE C/ABS 10-12 LINCOLN MKZ 09-12		MERCURY MILAN 10-11		FORD FIESTA MANUAL 11-14	
No. Lusac: 391247 Producto: CILINDRO MAESTRO		No. Lusac: 391249 Producto: CILINDRO MAESTRO		No. Lusac: 391251 Producto: CILINDRO MAESTRO	
		 Imagen Disponible Próximamente			
DIAMETRO	25.4 mm 1"	DIAMETRO	N/D	DIAMETRO	34mm
CHEVROLET CAMARO LT Y SS 6 V 10-13		BMW 528IA 11-12 535I 10-14 740I 10-14 750I 09-14 750LI 09-14		CHEVROLET EXPRESS 1500 08	









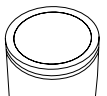

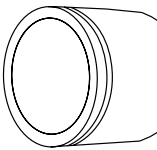





Fotografías de producto y especificaciones

No. Lusac: 391252 Producto: CILINDRO MAESTRO 		No. Lusac: 391253 Producto: CILINDRO MAESTRO 		No. Lusac: 391254 Producto: CILINDRO MAESTRO 	
DIAMETRO	1-5/16"	DIAMETRO	1-5/16"	DIAMETRO	23.8 mm 15/16"
CHEVROLET EXPRESS 1500 09-11		CHEVROLET EXPRESS 1500 09-11		FORD TRANSIT 10-13	
No. Lusac: 391255 Producto: CILINDRO MAESTRO 		No. Lusac: 391256 Producto: CILINDRO MAESTRO 		No. Lusac: 391257 Producto: CILINDRO MAESTRO 	
DIAMETRO	26.9 mm 1-1/16"	DIAMETRO	27.0 mm	DIAMETRO	33.3 mm 1-5/16"
FORD FREESTAR S/C DE TRACCIÓN 06-07		FORD RANGER 10-11		FORD E350 08-08	
No. Lusac: 391258 Producto: CILINDRO MAESTRO 		No. Lusac: 391260 Producto: CILINDRO MAESTRO 		No. Lusac: 391261 Producto: CILINDRO MAESTRO 	
DIAMETRO	22.2 mm 7/8"	DIAMETRO	23.8 mm 15/16"	DIAMETRO	23.8 mm 15/16"
MAZDA CX-7 07-12		MITSUBISHI LANCER EVOLUTION 08-11 LANCER GSR 08-11		MITSUBISHI LANCER EVOLUTION 08-10 LANCER MR Y TUNING 08-10	
No. Lusac: 391263 Producto: CILINDRO MAESTRO 		No. Lusac: 391264 Producto: CILINDRO MAESTRO 		No. Lusac: 391265 Producto: CILINDRO MAESTRO 	
DIAMETRO	7/8"	DIAMETRO	7/8"	DIAMETRO	7/8"
SUZUKI SX4 MANUAL S/C DE ESTABILIDAD 07-11		SUZUKI SX4 S/C DE ESTABILIDAD 07-12		SUZUKI SX4 MANUAL 07-11	







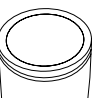

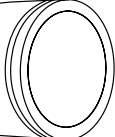



No. Lusac: 391266 Producto: CILINDRO MAESTRO 		No. Lusac: 391267 Producto: CILINDRO MAESTRO 		No. Lusac: 391268 Producto: CILINDRO MAESTRO 	
DIAMETRO	7/8"	DIAMETRO	23.8 mm 15/16"	DIAMETRO	N/D
SUZUKI SX4 12 SX4 AUTOMÁTICO 07-09 SX4 CVT AUTOMÁTICO 10-11		NISSAN ROGUE 08-14		INFINITI QX70 14 FX35 S/C DE VELOCIDAD 12 FX37 S/C DE VELOCIDAD 13 FX50 S/C DE VELOCIDAD 12-13	
No. Lusac: 391269 Producto: CILINDRO MAESTRO 		No. Lusac: 391271 Producto: CILINDRO MAESTRO 		No. Lusac: 391274 Producto: CILINDRO MAESTRO 	
DIAMETRO	1"	DIAMETRO	23.8 mm 15/16"	DIAMETRO	7/8"
INFINITI G37 12-13		NISSAN 370Z 09-14		DODGE JOURNEY 09-14	
No. Lusac: 391294 Producto: CILINDRO MAESTRO 		No. Lusac: 391295 Producto: CILINDRO MAESTRO 		No. Lusac: 391296 Producto: CILINDRO MAESTRO 	
DIAMETRO	13/16"	DIAMETRO	13/16	DIAMETRO	22.2 mm 7/8"
TOYOTA TACOMA MANUAL 09-14		TOYOTA TACOMA AUTOMÁTICA 09-14		TOYOTA RAV4 06-13	
No. Lusac: 391299 Producto: CILINDRO MAESTRO 		No. Lusac: 391303 Producto: CILINDRO MAESTRO 		No. Lusac: 391304 Producto: CILINDRO MAESTRO 	
DIAMETRO	13/16"	DIAMETRO	13/16	DIAMETRO	7/8"
TOYOTA RAV4 LARGA 06-13		NISSAN PATHFINDER 6 V 10-12 FRONTIER AUTOMÁTICA 08-13		NISSAN TIIDA 07-12	









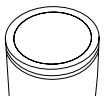

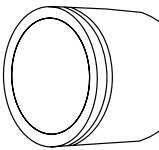





Fotografías de producto y especificaciones

No. Lusac: 391306 Producto: CILINDRO MAESTRO 		No. Lusac: 391307 Producto: CILINDRO MAESTRO 		No. Lusac: 391308 Producto: CILINDRO MAESTRO 	
DIAMETRO	13/16"	DIAMETRO	13/16"	DIAMETRO	23.8 mm 15/16"
NISSAN SENTRA 07-10		NISSAN SENTRA 07-10		NISSAN ALTIMA S, SL, SE SEDAN 2.5 4 L DOHC AUTOMÁTICA 07-09	
No. Lusac: 391309 Producto: CILINDRO MAESTRO 		No. Lusac: 391310 Producto: CILINDRO MAESTRO 		No. Lusac: 391311 Producto: CILINDRO MAESTRO 	
DIAMETRO	13/16"	DIAMETRO	13/16"	DIAMETRO	23.8 mm 15/16"
NISSAN ALTIMA 2.5 10 ALTIMA S, SL, SE SEDAN 2.5 4 L DOHC MANUAL S/C DE ESTABILIDAD 09 ALTIMA S, SL, SE SEDAN 2.5 4 L DOHC MANUAL 08		NISSAN ALTIMA S, SL, SE SEDAN 3.5 6 V DOHC AUTOMÁTICA 12-14 ALTIMA S, SL, SE SEDAN 3.5 6 V DOHC AUTOMÁTICA 11-12 ALTIMA S, SL, SE SEDAN 3.5 6 V DOHC AUTOMÁTICA 11		NISSAN ALTIMA S, SL, SE SEDAN 2.5 4 L DOHC MANUAL S/C DE ESTABILIDAD 07 ALTIMA S, SL, SE SEDAN 3.5 6 V DOHC AUTOMÁTICA 10 ALTIMA S, SL, SE SEDAN 3.5 6 V DOHC AUTOMÁTICA 07-09 ALTIMA S, SL, SE SEDAN 3.5 6 V DOHC MANUAL 13-14 ALTIMA S, SL, SE SEDAN 3.5 6 V DOHC MANUAL 11-12 ALTIMA S, SL, SE SEDAN 3.5 6 V DOHC MANUAL 07-11	
No. Lusac: 391314 Producto: CILINDRO MAESTRO 		No. Lusac: 391315 Producto: CILINDRO MAESTRO 		No. Lusac: 391316 Producto: CILINDRO MAESTRO 	
DIAMETRO	13/16"	DIAMETRO	13/16"	DIAMETRO	7/8"
CHEVROLET COBALT NATURAL MANUAL C/C ACTIVO DE FRENOS 08 PONTIAC G5 GT COUPE MANUAL C/ABS 08		PONTIAC G5 GT COUPE AUTOMÁTICA C/C ACTIVO DE FRENOS 08 G5 GT SEDAN AUTOMÁTICA C/C ACTIVO DE FRENOS 08		ACURA RDX 2.3 4 L TURBO 07-12	







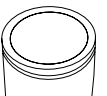

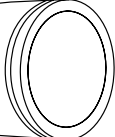







No. Lusac: 391319 Producto: CILINDRO MAESTRO 		No. Lusac: 391321 Producto: CILINDRO MAESTRO 		No. Lusac: 391322 Producto: CILINDRO MAESTRO 	
DIAMETRO	13/16"	DIAMETRO	13/16	DIAMETRO	25.4 mm 1"
FORD MUSTANG CONVERTIBLE C/ABS 11-14		MINI COOPER S 04-08 COOPER 02-08 COOPER S 02-03		MITSUBISHI ECLIPSE GT 10-12 ECLIPSE GT 10-12	
No. Lusac: 391323 Producto: CILINDRO MAESTRO 		No. Lusac: 391324 Producto: CILINDRO MAESTRO 		No. Lusac: 391325 Producto: CILINDRO MAESTRO 	
DIAMETRO	13/16"	DIAMETRO	13/16"	DIAMETRO	26.9 mm 1-1/16"
SUBARU LEGACY 2.5 GT AUTOMÁTICO S/C DE ESTABILIDAD 08-08 LEGACY 2.5 GT MANUAL 08-08 LEGACY 2.5 GT S/C DE ESTABILIDAD 08-08 LEGACY 2.5 GT 05-08 OUTBACK 05-08 OUTBACK S/C DE ESTABILIDAD 05-05		SUBARU FORESTER 09-13 OUTBACK 08-09 LEGACY 08-08 LEGACY 2.5 4 H 08-08 LEGACY AUTOMÁTICO 08-08 LEGACY 08-08 OUTBACK 08-08 IMPREZA 07-14 LEGACY 2.5 4 H 07-08 OUTBACK 05-08 OUTBACK 05-05		BMW X6 09-14 X5 07-14	
No. Lusac: 391327 Producto: CILINDRO MAESTRO  Imagen Disponible Próximamente		No. Lusac: 391328 Producto: CILINDRO MAESTRO 		No. Lusac: 391329 Producto: CILINDRO MAESTRO 	
DIAMETRO	13/16"	DIAMETRO	13/16"	DIAMETRO	15/16"
ACURA RL 3.7 6 V 07-11		CHEVROLET HHR MANUAL 06-08		CHEVROLET HHR 06-09	
No. Lusac: 391330 Producto: CILINDRO MAESTRO 		No. Lusac: 391331 Producto: CILINDRO MAESTRO 		No. Lusac: 391332 Producto: CILINDRO MAESTRO 	
DIAMETRO	13/16"	DIAMETRO	13/16"	DIAMETRO	7/8"
NISSAN ALTIMA 07-11		CHEVROLET AVEO AUTOMÁTICA C/ABS 09-11		PONTIAC G3 AUTOMÁTICA C/ABS 09-10	
		CHEVROLET AVEO MANUAL C/ABS 09-11		PONTIAC G3 AUTOMÁTICA C/ABS 09-09	









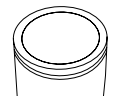

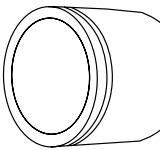





Fotografías de producto y especificaciones

No. Lusac: 391333 Producto: CILINDRO MAESTRO 		No. Lusac: 391337 Producto: CILINDRO MAESTRO 		No. Lusac: 391341 Producto: CILINDRO MAESTRO 	
DIAMETRO	13/16"	DIAMETRO	13/16"	DIAMETRO	25.4 mm 1"
CHEVROLET AVEO MANUAL S/ABS 09-11		PONTIAC G3 MANUAL S/ABS 09-10		TOYOTA CAMRY LE, XLE 07-08	
No. Lusac: 391342 Producto: CILINDRO MAESTRO 		No. Lusac: 391343 Producto: CILINDRO MAESTRO 		No. Lusac: 391344 Producto: CILINDRO MAESTRO 	
DIAMETRO	13/16"	DIAMETRO	13/16"	DIAMETRO	25.4 mm 1"
NISSAN MURANO 04		NISSAN MURANO 06-07		NISSAN MURANO 04-08	
No. Lusac: 391346 Producto: CILINDRO MAESTRO 		No. Lusac: 391347 Producto: CILINDRO MAESTRO 		No. Lusac: 391350 Producto: CILINDRO MAESTRO 	
DIAMETRO	13/16"	DIAMETRO	13/16"	DIAMETRO	25.4 mm 1"
AUDI A3 C/CILINDRO BOSCH 04-12		NISSAN JUKE 12-14		NISSAN MURANO 04-08	
No. Lusac: 391351 Producto: CILINDRO MAESTRO 		No. Lusac: 391353 Producto: CILINDRO MAESTRO 		No. Lusac: 391358 Producto: CILINDRO MAESTRO 	
DIAMETRO	13/16"	DIAMETRO	13/16"	DIAMETRO	15/16"
NISSAN GALANT 06-08		MINI COOPER S 04-08 COOPER 02-08		CHEVROLET HHR 10-11 HHR MANUAL 08-11	





No. Lusac: 391359 Producto: CILINDRO MAESTRO 		No. Lusac: 391363 Producto: CILINDRO MAESTRO 		No. Lusac: 391364 Producto: CILINDRO MAESTRO 	
DIAMETRO	13/16"	DIAMETRO	13/16"	DIAMETRO	22.2 mm 7/8"
FORD EXPEDITION 10		LINCOLN NAVIGATOR 10-10		HONDA ODYSSEY 11-12	
No. Lusac: 391365 Producto: CILINDRO MAESTRO 		No. Lusac: 391366 Producto: CILINDRO MAESTRO 		No. Lusac: 391376 Producto: CILINDRO MAESTRO 	
DIAMETRO	13/16"	DIAMETRO	13/16"	DIAMETRO	20.6 mm 13/16"
BMW 328I CONVERTIBLE 12-13 335I 07-14 328I COUPE 12-13 325I 06-07 X1 10-14 135I 08-13		MINI PACEMAN 13-13 COOPER S 09-13 COUNTRYMAN 12-13 COOPER 09-13		TOYOTA YARIS SEDAN 12-14	
No. Lusac: 391377 Producto: CILINDRO MAESTRO 		No. Lusac: 391378 Producto: CILINDRO MAESTRO 		No. Lusac: 391379 Producto: CILINDRO MAESTRO 	
DIAMETRO	13/16"	DIAMETRO	13/16"	DIAMETRO	23.8 mm 15/16"
MAZDA MAZDA3 SPEED 07-13		ACURA TL BASE 13 TL 3.7 6 V 09-12		HONDA ACCORD CROSSTOUR 10-11	
No. Lusac: 391382 Producto: CILINDRO MAESTRO 		No. Lusac: 391384 Producto: CILINDRO MAESTRO 		No. Lusac: 391385 Producto: CILINDRO MAESTRO 	
DIAMETRO	13/16"	DIAMETRO	13/16"	DIAMETRO	1-1/16"
INFINITI FX37 13-13 FX50 12-13 FX35 12-12		NISSAN NP300 14-14		AUDI TT QUATTRO 03-06 TT COUPE 00-06	
				JEEP LIBERTY 12-13 WRANGLER 07-14 SAHARA 07-14	

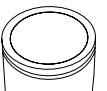

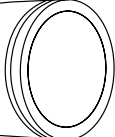





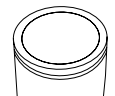

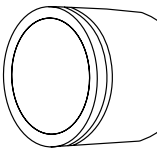

Fotografías de producto y especificaciones

No. Lusac: 391387 Producto: CILINDRO MAESTRO 		No. Lusac: 391390 Producto: CILINDRO MAESTRO  Imagen Disponible Próximamente		No. Lusac: 391393 Producto: CILINDRO MAESTRO  Imagen Disponible Próximamente	
DIAMETRO	13/16"	DIAMETRO	13/16"	DIAMETRO	26.9 mm 1-1/16"
FORD ESCAPE 13-14		AUDI A3 08-11 BORA TDI TURBO DIESEL 07-10 VOLKSWAGEN PASSAT C/CILINDRO TEVES 12-14 BORA ACTIVE 06-08 EOS 10-10 BORA GLI 06-07 BORA ACTIVE 08-10 BORA ACTIVE 06 GOLF A5 GTI 07-13 BORA TURBO 06		AUDI S6 QUATTRO 07-11 A6 QUATTRO 05-08 RS4 07-08 S4 04-09 A6 05-12	
No. Lusac: 391394 Producto: CILINDRO MAESTRO  Imagen Disponible Próximamente		No. Lusac: 391400 Producto: CILINDRO MAESTRO 		No. Lusac: 391401 Producto: CILINDRO MAESTRO  Imagen Disponible Próximamente	
DIAMETRO	13/16"	DIAMETRO	13/16"	DIAMETRO	15/16"
BMW X3 04-10		SAAB 9-3 08-12		NISSAN VERSA 12-14	
No. Lusac: 391402 Producto: CILINDRO MAESTRO  Imagen Disponible Próximamente		No. Lusac: 391403 Producto: CILINDRO MAESTRO  Imagen Disponible Próximamente		No. Lusac: 391411 Producto: CILINDRO MAESTRO 	
DIAMETRO	13/16"	DIAMETRO	13/16"	DIAMETRO	26.9 mm 1-1/16"
NISSAN SENTRA SE-R 2.5 4 L CVT 11-12 SENTRA SE-R 2.5 4 L 10		NISSAN SENTRA SE-R 2.5 4 L 10-12		NISSAN PATHFINDER 8 V 08-12	
No. Lusac: 475431 Producto: CILINDRO MAESTRO 		No. Lusac: 475973 Producto: CILINDRO MAESTRO 		No. Lusac: 3495064 Producto: CILINDRO MAESTRO 	
DIAMETRO	13/16"	DIAMETRO	13/16"	DIAMETRO	22.2 mm 7/8"
CHRYSLER STRATUS 98-02 GALANT C/ABS 03-03 MITSUBISHI ECLIPSE GT C/ABS 03-05		CHRYSLER STRATUS S/ABS 98-02 GALANT S/ABS 03-03 MITSUBISHI ECLIPSE GT S/ABS 03-05		CHEVROLET CORSA 02-05	

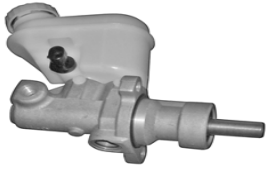

Fotografías de producto y especificaciones

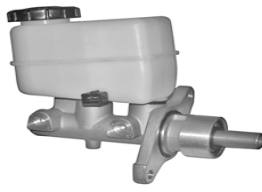
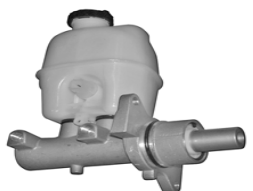
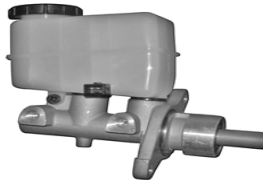



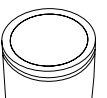

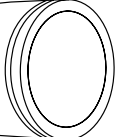

No. Lusac: 4721565 Producto: CILINDRO MAESTRO		No. Lusac: 5011260 Producto: CILINDRO MAESTRO		No. Lusac: 5015160 Producto: CILINDRO MAESTRO	
					
DIAMETRO	13/16"	DIAMETRO	13/16"	DIAMETRO	23.8 mm 15/16"
CHRYSLER TOWN & COUNTRY C/C DE TRACCIÓN 01-04		JEEP GRAND CHEROKEE 99-04		CHRYSLER PT CRUISER CONVERTIBLE C/ABS 05 PT CRUISER TURBO C/ABS 03-05 PT CRUISER C/ABS 01-05 NEON SEDAN C/ABS INCLUYE R/T 00-02	
No. Lusac: 5017973 Producto: CILINDRO MAESTRO		No. Lusac: 05019401 Producto: CILINDRO MAESTRO		No. Lusac: 05069615 Producto: CILINDRO MAESTRO	
					
DIAMETRO	13/16"	DIAMETRO	13/16"	DIAMETRO	20.6 mm 13/16"
CHRYSLER PT CRUISER S/ABS 01-05 NEON SEDAN S/ABS INCLUYE R/T 00-02		CHRYSLER STRATUS 02-04		DODGE ATOS CON 2 SALIDAS 01-07	
No. Lusac: 5080888 Producto: CILINDRO MAESTRO		No. Lusac: 5083353 Producto: CILINDRO MAESTRO		No. Lusac: 9193225 Producto: CILINDRO MAESTRO	
					
DIAMETRO	13/16"	DIAMETRO	13/16"	DIAMETRO	23.8 mm 15/16"
DODGE RAM 1500 3.7 6 V OHC C/ABS 03-04 RAM 1500 4X4 C/ABS 02		DODGE ATOS CON 4 SALIDAS 01-07		CHEVROLET ZAFIRA 02-06 ASTRA INC VAGONETA 1.8 S/ABS 01-03 ASTRA INC VAGONETA 2.2L S/ABS 01-03 ASTRA 1.8 S/ABS 00-00	

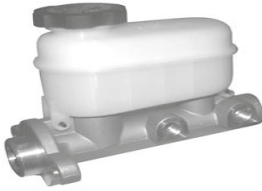
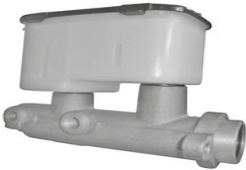



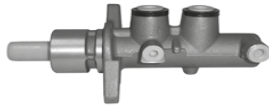



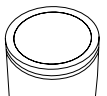

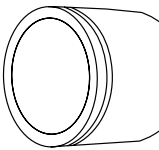

Fotografías de producto y especificaciones

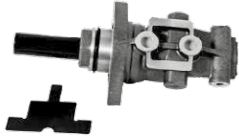
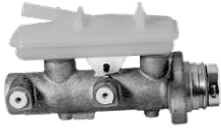
No. Lusac: 18026274 Producto: CILINDRO MAESTRO 		No. Lusac: 18029970 Producto: CILINDRO MAESTRO 		No. Lusac: 18060790 Producto: CILINDRO MAESTRO 	
DIAMETRO	13/16"	DIAMETRO	13/16"	DIAMETRO	37.0 mm
CHEVROLET BLAZER 98-99		CHEVROLET C3500 99-99 C3500 92-95 C3500HD 99-99		CADILLAC ESCALADE02- 03 SILVERADO 1500 4X4 03-04 ESCALADE EXT 02 SILVERADO 1500 4X2 03 CHEVROLET SILVERADO 1500 4X4 03 SILVERADO 1500 4X2 06 SILVERADO 1500 4X2 01 SILVERADO 1500 4X4 06 SILVERADO 1500 4X2 01 SILVERADO 1500 4X2 05-06 SILVERADO 1500 4X4 01 SILVERADO 1500 4X4 05-06 SILVERADO 1500 4X2 00-01 SILVERADO 1500 4X2 04-05 SILVERADO 1500 4X4 00-01 SILVERADO 1500 4X4 04-05 SILVERADO 1500 4X2 00 SILVERADO 1500 4X2 03-04 SILVERADO 1500 4X4 00	
No. Lusac: 39009900 Producto: CILINDRO MAESTRO 		No. Lusac: 39009901 Producto: CILINDRO MAESTRO 		No. Lusac: 39009902 Producto: CILINDRO MAESTRO 	
DIAMETRO	13/16"	DIAMETRO	13/16"	DIAMETRO	20.6 mm 13/16"
DODGE H100 03-06		DODGE VERNA 04-06		CHEVROLET CHEVY PICKUP 99-03 CHEVY C2 1.6 4 L 04-12	
No. Lusac: 39009903 Producto: CILINDRO MAESTRO 		No. Lusac: 39009904 Producto: CILINDRO MAESTRO 		No. Lusac: 39009906 Producto: CILINDRO MAESTRO 	
DIAMETRO	13/16"	DIAMETRO	13/16"	DIAMETRO	15/16"
CHEVROLET ASTRA 1.8 4 L 07-08 ASTRA 2 4 L C/ABS 00-06 ASTRA TURBO 07-08 ASTRA 1.8 4 L 00-03 ASTRA 2.2 4 L DOHC C/ABS 01-03 ASTRA VAGONETA 01-03		FORD FIESTA 98-01 IKON 01-07 FIESTA FIRST, TREND SEDAN 10-10 08-10 07-08 06-07 05-06 03-05 COURIER PICKUP 01-10		FORD ECOSPORT 04-10 FIESTA 1.6 03-10	



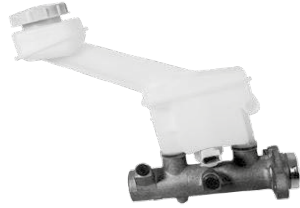

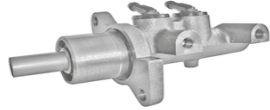

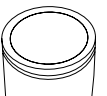

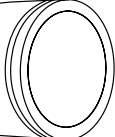

No. Lusac: 39009907 Producto: CILINDRO MAESTRO		No. Lusac: 39009908 Producto: CILINDRO MAESTRO		No. Lusac: 39009909 Producto: CILINDRO MAESTRO	
					
DIAMETRO	13/16"	DIAMETRO	13/16"	DIAMETRO	13/16"
CHEVROLET TORNADO 09-11		NISSAN URVAN CARGA C/ABS 00-11		TOYOTA HIACE 06-13	
No. Lusac: 39009910 Producto: CILINDRO MAESTRO		No. Lusac: 39009911 Producto: CILINDRO MAESTRO		No. Lusac: 39009912 Producto: CILINDRO MAESTRO	
					
DIAMETRO	13/16"	DIAMETRO	13/16"	DIAMETRO	3/4"
NISSAN URVAN CARGA C/ABS 02-11 URVAN CARGA S/ABS 00-01		VOLKSWAGEN SAVEIRO S/ABS 10-14		VOLKSWAGEN CROSSFOX C/ABS 11-14 LUPO 1.6 4 L C/ABS 08-09 SAVEIRO C/ABS 10-14	
No. Lusac: 39009913 Producto: CILINDRO MAESTRO		No. Lusac: 39009914 Producto: CILINDRO MAESTRO		No. Lusac: 39009915 Producto: CILINDRO MAESTRO	
					
DIAMETRO	13/16"	DIAMETRO	13/16"	DIAMETRO	25.4 mm 1"
NISSAN NP300 GASOLINA 09-12		CHEVROLET MATIZ 06-09		NISSAN X-TRAIL AUTOMÁTICA 02-07	
No. Lusac: 39009916 Producto: CILINDRO MAESTRO		No. Lusac: 93172089 Producto: CILINDRO MAESTRO		No. Lusac: 93305031 Producto: CILINDRO MAESTRO	
					
DIAMETRO	13/16"	DIAMETRO	13/16"	DIAMETRO	23.8 mm 15/16"
ISUZU ELF-300 09-11 ELF-450 06-08 ELF-400 09-11		CHEVROLET SAAB VECTRA 2.2 4 L DOHC 03-05 9-3 06-09		CHEVROLET TORNADO 04-08 MERIVA 04-06	

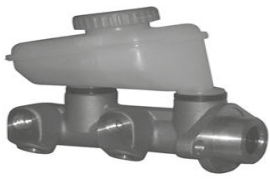



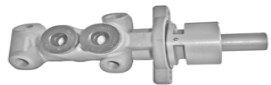
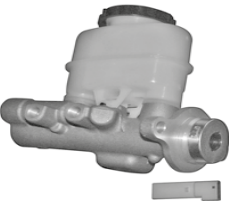

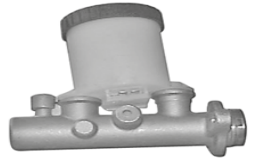
Fotografías de producto y especificaciones

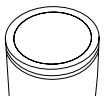
No. Lusac: 390700RL Producto: CILINDRO MAESTRO		No. Lusac: 390801RL Producto: CILINDRO MAESTRO		No. Lusac: 390901RL Producto: CILINDRO MAESTRO	
					
DIAMETRO	13/16"	DIAMETRO	13/16"	DIAMETRO	20.6 mm 13/16"
PEUGEOT 206 XR, XT 01-07		CHEVROLET CHEVY JOY, SWING, POP, MONZA 99 CHEVY MONZA 99-00 CHEVY JOY, SWING 97-98 CHEVY MONZA 97-98 CHEVY JOY, SWING 95-97 CHEVY MONZA 02-03 CHEVY MONZA 01-02 CHEVY POP 00-03 CHEVY JOY 00-02 CHEVY SWING 00-02 CHEVY MONZA 00-01 CHEVY POP, MONZA, VAGONETA 00 CHEVY JOY, SWING, POP, MONZA, VAGONETA 01-03		VOLKSWAGEN POINTER VAGONETA 99-02 POINTER 1.8 4 L 98-02 POINTER CITY 02-02	
No. Lusac: 390911RL Producto: CILINDRO MAESTRO		No. Lusac: 390921RL Producto: CILINDRO MAESTRO		No. Lusac: 4601000Q Producto: CILINDRO MAESTRO	
					
DIAMETRO	13/16"	DIAMETRO	13/16"	DIAMETRO	20.6 mm 13/16"
SEAT TOLEDO 04-06 TOLEDO 1.8 4 L TURBO 02-04 IBIZA 01-09 TOLEDO 1.8 4 L 01-03		SEAT CORDOBA 02-09 LEON 1.8 4 L TURBO 01-06 VOLKSWAGEN GOLF A3 CL, A3 GL 93-94 JETTA A3 GLS, A3 EUROPA 93 GOLF A2 C, A2 CL, A2 GL 90-92 JETTA A2 89-92 GOLF A2 C, A2 CL, A2 GL 89-90 GOLF A2 GTI 89-90 GOLF A2 C, A2 CL, A2 GL 87-89 GOLF A2 C, A2 CL, A2 GL 92 PASSAT 91-93		NISSAN PLATINA 02-10 RENAULT CLIO EXPRESSION 04-08 CLIO 02-10	
No. Lusac: 460107B7 Producto: CILINDRO MAESTRO		No. Lusac: 46010A05 Producto: CILINDRO MAESTRO		No. Lusac: 46010F40 Producto: CILINDRO MAESTRO	
					
DIAMETRO	13/16"	DIAMETRO	13/16"	DIAMETRO	23.8 mm 15/16"
NISSAN FRONTIER 2.4 01-02		NISSAN TSURU II 88-92		NISSAN PICKUP NISSAN C/CILINDRO TOKICO 94-97 PICKUP NISSAN 94-96	

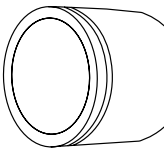

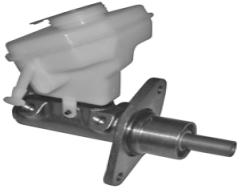

No. Lusac: F7RZ2140 Producto: CILINDRO MAESTRO		No. Lusac: LJ1614019 Producto: CILINDRO MAESTRO		No. Lusac: MIS55214 Producto: CILINDRO MAESTRO	
					
DIAMETRO	13/16"	DIAMETRO	13/16"	DIAMETRO	22.2 mm 7/8"
FORD CONTOUR 96-00		VOLKSWAGEN BEETLE GL, GLS, GLX, CABRIOLET TURBO 98-99 JETTA A4 00-07 GOLF A4 S/C DE ESTABILIDAD 05-07 GOLF A4 S/C DE ESTABILIDAD 00-03 BEETLE GL, GLS, GLX, CABRIOLET TURBO 04-05 GOLF A4 1.9 S/C DE ESTABILIDAD 04 BEETLE GL, GLS, GLX, CABRIOLET TURBO 01-04		FORD KA INCLUYE SPORT C/CILINDRO RAYBESTOS-VARGA 01-08	

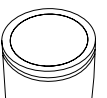

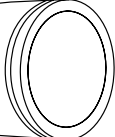

Fotografías de producto y especificaciones

No. Lusac: 834 Producto: CILINDRO DE RUEDA		No. Lusac: 844 Producto: CILINDRO DE RUEDA		No. Lusac: 17507 Producto: CILINDRO DE RUEDA	
					
DIAMETRO	19.0 mm 3/4"	DIAMETRO	19.0 mm 3/4"	DIAMETRO	7/8"
CHEVROLET ASTRA 1.8 00-03 SPARK 11-12 CHEVY SWING JOY, POP, MONZA, VAGONETA 95-03 TIGRA 99 CHEVY PICKUP 01-01 ZAFIRA 02-06 CORSA 02-08 MERIVA 04-08		CHEVROLET CHEVY C2 04-12		DODGE JEEP D250 86-87 CHEROKEE 91-93 95-97 D350 INCLUYE MICROBUS 88-90 CJ7 84-86 DURANGO 98-99 GRAND CHEROKEE 93-98 RAM 3500 MAXI WAGON 95-97 WAGONEER 85-86 RAM VAN 3500 95-97	
No. Lusac: 17508 Producto: CILINDRO DE RUEDA		No. Lusac: 34876 Producto: CILINDRO DE RUEDA		No. Lusac: 37208 Producto: CILINDRO DE RUEDA	
					
DIAMETRO	7/8"	DIAMETRO	13/16"	DIAMETRO	3/4"
DODGE JEEP D250 86-87 CHEROKEE 91-93 95-97 D350 INCLUYE MICROBUS 88-90 CJ7 84-86 DURANGO 98-99 GRAND CHEROKEE 93-98 RAM 3500 MAXI WAGON 95-97 WAGONEER 85-86 RAM VAN 3500 95-97		FORD RANGER 02-03 01-03 B2500 98-01 MAZDA B2300 01-03		NISSAN PICKUP NISSAN DOBLE CABINA 82-97	
No. Lusac: 37209 Producto: CILINDRO DE RUEDA		No. Lusac: 37210 Producto: CILINDRO DE RUEDA		No. Lusac: 37250 Producto: CILINDRO DE RUEDA	
					
DIAMETRO	13/16"	DIAMETRO	13/16"	DIAMETRO	30.1 mm 1-3/16"
NISSAN PICKUP NISSAN INCLUYE ESTAQUITAS 80-86 95-97		NISSAN PICKUP NISSAN INCLUYE ESTAQUITAS 80-86		FORD E350 CLUB WAGON 93-94, 98 P350 MICROBUS 97	

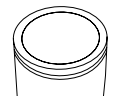

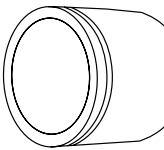



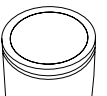

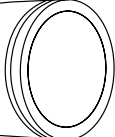
No. Lusac: 37251 Producto: CILINDRO DE RUEDA		No. Lusac: 37358 Producto: CILINDRO DE RUEDA		No. Lusac: 37376 Producto: CILINDRO DE RUEDA	
					
DIAMETRO	30.1 mm 1-3/16"	DIAMETRO	11/16"	DIAMETRO	3/4"
FORD E350 CLUB WAGON 93-94, 98 P350 MICROBUS 97		NISSAN TSUBAME 93-04		CHRYSLER SEBRING 01-05 STRATUS 01-05	
				MITSUBISHI ECLIPSE 96-05 GALANT 00-03	
No. Lusac: 37407 Producto: CILINDRO DE RUEDA		No. Lusac: 37574 Producto: CILINDRO DE RUEDA		No. Lusac: 37576 Producto: CILINDRO DE RUEDA	
					
DIAMETRO	13/16"	DIAMETRO	3/4"	DIAMETRO	5/8"
NISSAN ICHI VAN 87-94		FORD RANGER 96-00		VOLKSWAGEN GOL 09-14	
No. Lusac: 37599 Producto: CILINDRO DE RUEDA		No. Lusac: 37660 Producto: CILINDRO DE RUEDA		No. Lusac: 37684 Producto: CILINDRO DE RUEDA	
					
DIAMETRO	7/8"	DIAMETRO	7/8"	DIAMETRO	15/16"
CHEVROLET LUV 97-05 ISUZU AMIGO 00-00		FORD RODEO SPORT 00-04 FOCUS ZX3 00-04		NISSAN FRONTIER D22 09-11 PICKUP NISSAN NP300 87-97 09-12	



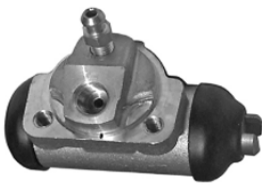

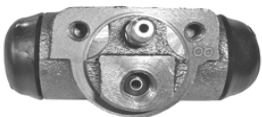



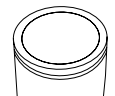

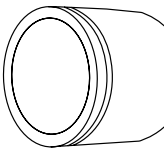
Fotografías de producto y especificaciones

No. Lusac: 37690 Producto: CILINDRO DE RUEDA 		No. Lusac: 37693 Producto: CILINDRO DE RUEDA 		No. Lusac: 37708 Producto: CILINDRO DE RUEDA 					
DIAMETRO	1"	DIAMETRO	3/4"	DIAMETRO	7/8"				
TOYOTA TUNDRA 00-06		NISSAN ALTIMA 96-00		FORD MONDEO SPORT XLS 03-04		MITSUBISHI MONTERO SPORT 99-04			
No. Lusac: 37709 Producto: CILINDRO DE RUEDA 		No. Lusac: 37779 Producto: CILINDRO DE RUEDA 		No. Lusac: 37787 Producto: CILINDRO DE RUEDA 					
DIAMETRO	7/8"	DIAMETRO	3/4"	DIAMETRO	11/16"				
FORD MONDEO SPORT XLS 03-04		MITSUBISHI MONTERO SPORT 99-04		OLDSMOBILE SILHOUETTE 91		CHRYSLER NEON 00-05		MAZDA 626 88-02	
				FORD ESCORT VAGONETA 91-02		FORD PROTEGE 99-03			
				KIA SPECTRA 01-04					
No. Lusac: 37844 Producto: CILINDRO DE RUEDA 		No. Lusac: 37846 Producto: CILINDRO DE RUEDA 		No. Lusac: 37847 Producto: CILINDRO DE RUEDA 					
DIAMETRO	3/4"	DIAMETRO	3/4"	DIAMETRO	3/4"				
DODGE DAKOTA 87-95 97-02		HONDA CIVIC CX 93-01		HONDA CIVIC CX 93-00					

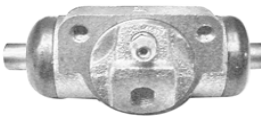
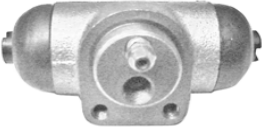
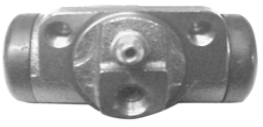

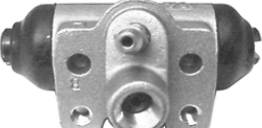

No. Lusac: 37852 Producto: CILINDRO DE RUEDA		No. Lusac: 37853 Producto: CILINDRO DE RUEDA		No. Lusac: 37854 Producto: CILINDRO DE RUEDA	
					
DIAMETRO	15/16"	DIAMETRO	15/16"	DIAMETRO	7/8"
CHEVROLET TRACKER 93-95		CHEVROLET TRACKER 93-95		CHEVROLET GMC ASTRO 90-02 SONOMA 03 BLAZER 95-97 S-10 03-04	
No. Lusac: 37855 Producto: CILINDRO DE RUEDA		No. Lusac: 37856 Producto: CILINDRO DE RUEDA		No. Lusac: 37857 Producto: CILINDRO DE RUEDA	
					
DIAMETRO	23.8 mm 15/16"	DIAMETRO	7/8"	DIAMETRO	1"
CADILLAC OLDSMOBILE DEVILLE CONCOURS EIGHTY EIGHT 92-95 CONCOURS 91-96		FORD AEROSTAR 91-93 EXPLORER 91-94		MERCURY NISSAN SABLE VAGONETA 93-05 QUEST 97-98	
CHEVROLET PONTIAC LUMINA 95-96 VENTURE APV 97-04 BONNEVILLE 94-95					
No. Lusac: 37858 Producto: CILINDRO DE RUEDA		No. Lusac: 37859 Producto: CILINDRO DE RUEDA		No. Lusac: 37862 Producto: CILINDRO DE RUEDA	
					
DIAMETRO	13/16"	DIAMETRO	13/16"	DIAMETRO	13/16"
HONDA ACCORD EX 94-00 CR-V 97-01		HONDA ACCORD EX 94-02 CR-V 97-01		JEEP CHEROKEE 94-01 WRANGLER SAHARA 93-99	

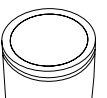

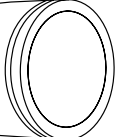

Fotografías de producto y especificaciones

No. Lusac: 37863 Producto: CILINDRO DE RUEDA		No. Lusac: 37864 Producto: CILINDRO DE RUEDA		No. Lusac: 37866 Producto: CILINDRO DE RUEDA	
					
DIAMETRO	3/4"	DIAMETRO	15.8 mm 5/8"	DIAMETRO	19.0 mm 3/4"
CHRYSLER GRAND VOYAGER 95 VOYAGER 94-95 TOWN & COUNTRY 93-96		DODGE SPIRIT 90-95		MAZDA MAZDA2 12-14	
No. Lusac: 37869 Producto: CILINDRO DE RUEDA		No. Lusac: 37870 Producto: CILINDRO DE RUEDA		No. Lusac: 37871 Producto: CILINDRO DE RUEDA	
					
DIAMETRO	15.8 mm 5/8"	DIAMETRO	13/16"	DIAMETRO	13/16"
NISSAN SENTRA GSS, GSX, GST, SE 92, 96-01 TSURU GSR 2000 93-96		NISSAN URVAN CARGA 00-11		NISSAN FRONTIER 98-00 PICKUP NISSAN 95-97 PATHFINDER 97-98	
No. Lusac: 37872 Producto: CILINDRO DE RUEDA		No. Lusac: 37961 Producto: CILINDRO DE RUEDA		No. Lusac: 37962 Producto: CILINDRO DE RUEDA	
					
DIAMETRO	7/8"	DIAMETRO	11/16"	DIAMETRO	11/16"
NISSAN PICKUP NISSAN 90-97		CHEVROLET SUZUKI ESTEEM 00-02 AERIO GL, GLS 06-07		CHEVROLET SUZUKI ESTEEM 00-02 AERIO GL, GLS 06-07	

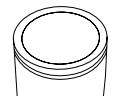

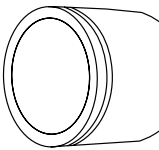



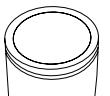

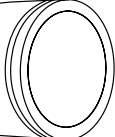



No. Lusac: 37967 Producto: CILINDRO DE RUEDA		No. Lusac: 37969 Producto: CILINDRO DE RUEDA		No. Lusac: 37970 Producto: CILINDRO DE RUEDA	
					
DIAMETRO	13/16"	DIAMETRO	19.0 mm 3/4"	DIAMETRO	3/4"
CHEVROLET BLAZER 98-01 S-10 95-02 GMC SONOMA 92-02		DODGE 2000GTX 89-92 EAGLE 2000 GTX 90-93		MITSUBISHI GALANT 89-93 MIRAGE 93-98	
ISUZU HOMBRE 96-00				CHRYSLER STRATUS 95-00	
No. Lusac: 37973 Producto: CILINDRO DE RUEDA		No. Lusac: 37975 Producto: CILINDRO DE RUEDA		No. Lusac: 37976 Producto: CILINDRO DE RUEDA	
					
DIAMETRO	13/16"	DIAMETRO	7/8"	DIAMETRO	7/8"
PONTIAC FIREBIRD TRANS AM 94-97		CHEVROLET TRACKER 98		CHEVROLET TRACKER 98	
No. Lusac: 37984 Producto: CILINDRO DE RUEDA		No. Lusac: 37985 Producto: CILINDRO DE RUEDA		No. Lusac: 37986 Producto: CILINDRO DE RUEDA	
					
DIAMETRO	17.4 mm 11/16"	DIAMETRO	15/16"	DIAMETRO	3/4"
CHRYSLER GRAND VOYAGER 91-00		CHEVROLET EXPRESS 1500 96-96 98-02 EXPRESS 2500 CARGO VAN, EXT 04-06, 96-99 DODGE D250 INLUYE CLUB CAB 91-92 RAM 1500 94-01		RAM 2500 INCLUYE CLUB CAB 94-01 GMC SAVANA 1500 96-02 SAVANA 2500 EXT 96-02	
				SEAT CORDOBA 02-06 IBIZA 01-07 01-07 VOLKSWAGEN CABRIO A3 A3 96-99 DERBY 95-09	
				GOLF A3 CL, 93-00 JETTA A3 CL EUROPA , GLS, 93-00 LUPO 05-09 POLO 03-07	









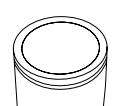

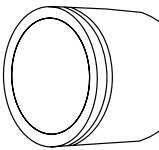

Fotografías de producto y especificaciones

No. Lusac: 37997 Producto: CILINDRO DE RUEDA 		No. Lusac: 37999 Producto: CILINDRO DE RUEDA 		No. Lusac: 51081 Producto: CILINDRO DE RUEDA 	
DIAMETRO	7/8"	DIAMETRO	15/16"	DIAMETRO	23.8 mm 15/16"
FORD CONTOUR 96-00		MERCURY MYSTIQUE 95-00		FORD AEROSTAR 94-95	
				CHEVROLET C15 82-86 CHEVY VAN 95	
No. Lusac: 51088 Producto: CILINDRO DE RUEDA 		No. Lusac: 57146 Producto: CILINDRO DE RUEDA 		No. Lusac: 57147 Producto: CILINDRO DE RUEDA 	
DIAMETRO	25.4 mm 1"	DIAMETRO	25.4 mm 1"	DIAMETRO	25.4 mm 1"
CHEVROLET C15 82-86 C20 79-86		FORD F200 86-86		FORD F200 86-86	
No. Lusac: 59240 Producto: CILINDRO DE RUEDA 		No. Lusac: 59241 Producto: CILINDRO DE RUEDA 		No. Lusac: 78974 Producto: CILINDRO DE RUEDA 	
DIAMETRO	23.8 mm 15/16"	DIAMETRO	23.8 mm 15/16"	DIAMETRO	25.4 mm 1"
FORD E150 ECONLINE WAGON 95-96 F150 87-99		FORD E150 ECONLINE WAGON 95-96 F150 87-99		DODGE D350 INCLUYE MICROBUS 81-87 DAKOTA 00-04 DURANGO 99-04 RAM 1500 02 RAM VAN 1500 98-03 RAM VAN 2500 99-02 98-02 RAM WAGON 1500 98-03 RAM WAGON 2500 98-02 W250 89-93	
				FORD E150 ECONLINE WAGON 95-99 E250 ECONLINE VAN 85-94 E350 ECONLINE CLUB WAGON 97-98 F150 XL 97-04 F200 86, 90-91 F250 XL 92, 94, 97-99 LOBO 04-04	

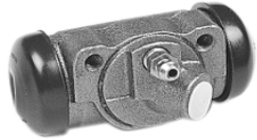

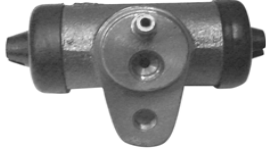



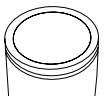

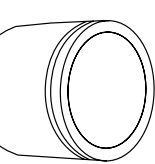

No. Lusac: 78975 Producto: CILINDRO DE RUEDA		No. Lusac: 79767 Producto: CILINDRO DE RUEDA		No. Lusac: 079768 Producto: CILINDRO DE RUEDA	
					
DIAMETRO	25.4 mm 1"	DIAMETRO	26.9 mm 1-1/16"	DIAMETRO	30.1 mm 1-3/16"
DODGE D350 INCLUYE MICROBUS 81-87 DAKOTA 00-04 DURANGO 99-04 RAM 1500 02-02 RAM VAN 1500 98-03 RAM VAN, WAGON 2500 98-02 RAM WAGON 1500 98-03 W250 89-93		FORD E150 ECONOLINE WAGON ECONOLINE VAN 95-07 E250 ECONOLINE VAN 85-94 E350 ECONOLINE CLUB WAGON 97-98 F150 XL 97-04 F200 86, 90-91 F250 XL 92, 94, 97-99 LOBO 04-04		CHEVROLET C2500 SILVERADO CLASSIC 96-00 C30 84-86 C3500 90, 92-95 EXPRESS 2500 EXT 96 EXPRESS 3500 CARGO VAN 97-02 K2500 96-99 DODGE SIERRA 4000 95-02 RAM SRT-10 05-06 RAM VAN 3500 98-99 GMC SAVANA 2500 EXT 96-02 SIERRA 2500 99-00 SIERRA K2500 CLASSIC 99-00	
CHEVROLET C30 84-86 C3500 90-99 C3500HD 96-99 EXPRESS 3500 EXT 96 MICROBUS 88-96		GMC P30 PANEL 82-92, 94-02 SAVANA 2500 EXT 01-02			
No. Lusac: 79794 Producto: CILINDRO DE RUEDA		No. Lusac: 79795 Producto: CILINDRO DE RUEDA		No. Lusac: 90549 Producto: CILINDRO DE RUEDA	
					
DIAMETRO	26.9 mm 1-1/16"	DIAMETRO	26.9 mm 1-1/16"	DIAMETRO	22.2 mm 7/8"
CHEVROLET C3500 89-89		CHEVROLET C3500 89-89		VOLKSWAGEN SEDAN 83-94	
No. Lusac: 93356 Producto: CILINDRO DE RUEDA		No. Lusac: 96387 Producto: CILINDRO DE RUEDA		No. Lusac: 96399 Producto: CILINDRO DE RUEDA	
					
DIAMETRO	17.4 mm 11/16"	DIAMETRO	23.8 mm 15/16"	DIAMETRO	17.4 mm 11/16"
VOLKSWAGEN SEDAN 83-04		VOLKSWAGEN COMBI 90-01 PANEL 90-01		VOLKSWAGEN ATLANTIC 81-87 CARIBE GT 78-87 CORSAR VARIANT 84-88 DERBY 95-97 GOLF A2, GL, CL, 87-92 JETTA A2 87-92 POINTER 98-09	

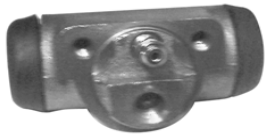





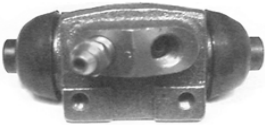
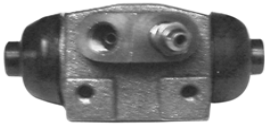
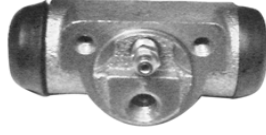

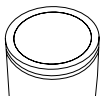

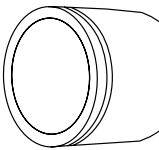

Fotografías de producto y especificaciones

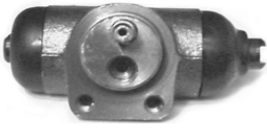
No. Lusac: 101604 Producto: CILINDRO DE RUEDA		No. Lusac: 101610 Producto: CILINDRO DE RUEDA		No. Lusac: 104384 Producto: CILINDRO DE RUEDA	
					
DIAMETRO	19.0 mm 3/4"	DIAMETRO	23.8 mm 15/16"	DIAMETRO	17.4 mm 11/16"
FORD RANGER 04-09 MAZDA B2300 04-10 B3000 04-08		LINCOLN TOWN CAR 81-02		BUICK CENTURY 83-89, 92-93 CHEVROLET CELEBRITY 85-86 CITATION 82-85 OLDSMOBILE CUTLASS 87-89	
No. Lusac: 106315 Producto: CILINDRO DE RUEDA		No. Lusac: 107475 Producto: CILINDRO DE RUEDA		No. Lusac: 107476 Producto: CILINDRO DE RUEDA	
					
DIAMETRO	23.8 mm 15/16"	DIAMETRO	14.2 mm 9/16"	DIAMETRO	15.8 mm 5/8"
DODGE D150 83-93 D250 86-93 RAM CHARGER 86-96 RAM VAN 1500 95-97 RAM VAN 2500 96-97 RAM WAGON 1500 95-97 RAM WAGON 2500 96-97 W150 85-87 W250 89-93		CHRYSLER LE BARON K 84-87 NEW YORKER 85-89 85-89 PHANTOM 87-89 DODGE SERIE 600K 84-85		CHRYSLER LE BARON K 83-87 NEON 95-99 NEW YORKER 85-89 PHANTOM 87-89 SEBRING 96-00 DODGE SERIE 600K 84-85 SHADOW GTS 89-94	
No. Lusac: 108106 Producto: CILINDRO DE RUEDA		No. Lusac: 108107 Producto: CILINDRO DE RUEDA		No. Lusac: 109532 Producto: CILINDRO DE RUEDA	
					
DIAMETRO	22.2 mm 7/8"	DIAMETRO	22.2 mm 7/8"	DIAMETRO	19.0 mm 3/4"
FORD GHIA 91-94 TOPAZ 84-94		FORD GHIA 91-94 TOPAZ 84-94		CHRYSLER GRAND VOYAGER 95 PT CRUISER 01-06 TOWN & COUNTRY 93-95 VOYAGER 95 DODGE DAKOTA 96 JEEP WRANGLER SAHARA, UNLIMITED RUBICON 97-02, 05 06	



Fotografías de producto y especificaciones





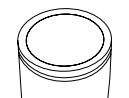

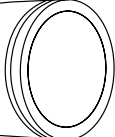



No. Lusac: 112341 Producto: CILINDRO DE RUEDA		No. Lusac: 112365 Producto: CILINDRO DE RUEDA		No. Lusac: 113757 Producto: CILINDRO DE RUEDA	
					
DIAMETRO	22.2 mm 7/8"	DIAMETRO	25.4 mm 1"	DIAMETRO	30.1 mm 1-3/16"
BUICK CENTURY 94-96 CHEVROLET CAVALIER 95-02 LUMINA 97-01		OLDSMOBILE CUTLASS 93-96 EUROSPOET 93-96 PONTIAC BONNEVILLE 96-99		FORD TAURUS 88-91	
		FORD F200 90-91 F250 92-93 95-97 F350 SUPER DUTY 99-04		P350 MICROBUS 96-96	
No. Lusac: 113758 Producto: CILINDRO DE RUEDA		No. Lusac: 114197 Producto: CILINDRO DE RUEDA		No. Lusac: 116224 Producto: CILINDRO DE RUEDA	
					
DIAMETRO	30.1 mm 1-3/16"	DIAMETRO	15.8 mm 5/8"	DIAMETRO	30.1 mm 1-3/16"
FORD F200 90-91 F250 92-93 95-97 F350 SUPER DUTY 98-04		NISSAN TSURU GSR 2000 GS III 93-16		CHEVROLET C1500 94-99 C2500 CHEYENNE 94-00	
				SONORA 00	
No. Lusac: 116263 Producto: CILINDRO DE RUEDA		No. Lusac: 116359 Producto: CILINDRO DE RUEDA		No. Lusac: 0116366 Producto: CILINDRO DE RUEDA	
					
DIAMETRO	28.5 mm 1-1/8"	DIAMETRO	25.4 mm 1"	DIAMETRO	17.4 mm 11/16"
CHEVROLET C1500 88-99 C2500 CHEYENNE 88-91, 96-00		CADILLAC ESCALADE 99-00 CHEVROLET C1500 95 CHEYENNE 92-99 EXPRESS 2500 EXT 96 EXPRESS 3500 VAN, EXT 97-00,96		K2500 96-99 SUBURBAN 1500, 2500 00-02 TAHOE 95-00 GMC SAVANA 2500 96-00	
				BUICK CENTURY 90-91 CHEVROLET CAVALIER Z24 92-05 CELEBRITY 87-89	
				OLDSMOBILE CUTLASS 90-92 EUROSPOET 91-92 PONTIAC SUNFIRE 95-02	

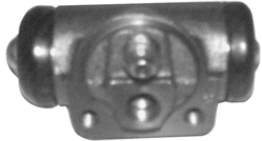



Fotografías de producto y especificaciones

No. Lusac: 116384 Producto: CILINDRO DE RUEDA 		No. Lusac: 117345 Producto: CILINDRO DE RUEDA 		No. Lusac: 129564 Producto: CILINDRO DE RUEDA 	
DIAMETRO	16.0 mm	DIAMETRO	19.0 mm 3/4"	DIAMETRO	25.4 mm 1"
CHEVROLET CAVALIER Z24 90-91		NISSAN HIKARI 88-92 TSURU II II 88-92		FORD COUGAR 95 THUNDERBIRD 89-96 WINDSTAR 95-03	
No. Lusac: 370027 Producto: CILINDRO DE RUEDA 		No. Lusac: 370031 Producto: CILINDRO DE RUEDA 		No. Lusac: 370032 Producto: CILINDRO DE RUEDA 	
DIAMETRO	3/4"	DIAMETRO	3/4"	DIAMETRO	15/16"
CHRYSLER GRAND VOYAGER 96-02 TOWN & COUNTRY 97-00 VOYAGER 96-00		FORD RANGER 96-97		TOYOTA HIACE 06-13 (Corta) TACOMA LIMITED SR5 S- RUNNER 95-04	
No. Lusac: 370042 Producto: CILINDRO DE RUEDA 		No. Lusac: 370043 Producto: CILINDRO DE RUEDA 		No. Lusac: 370051 Producto: CILINDRO DE RUEDA 	
DIAMETRO	28.5 mm 1-1/8"	DIAMETRO	28.5 mm 1-1/8"	DIAMETRO	20.6 mm 13/16"
FORD E150 ECONLINE WAGON, VAN 97 E250 ECONLINE VAN 98-99 E350 ECONLINE CLUB WAGON 95-96 F350 98-98		FORD E250 ECONLINE VAN 97-99 E350 ECONLINE CLUB WAGON 95-96 F350 98-98		CHRYSLER GRAND VOYAGER 97-02 TOWN & COUNTRY 97-07 VOYAGER 97-06	

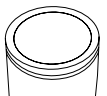

Fotografías de producto y especificaciones

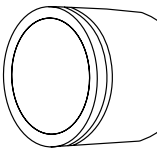

No. Lusac: 370055 Producto: CILINDRO DE RUEDA		No. Lusac: 370061 Producto: CILINDRO DE RUEDA		No. Lusac: 370073 Producto: CILINDRO DE RUEDA	
					
DIAMETRO	7/8"	DIAMETRO	13/16"	DIAMETRO	7/8"
CHEVROLET MALIBU LX, LS 97-05, 05		PONTIAC GRAND AM 99-05		FORD RANGER 98-05 B2500 98-01 MAZDA B2300 01-10	
CHEVROLET TRACKER 99-08				CHEVROLET TRACKER 99-08	
No. Lusac: 370074 Producto: CILINDRO DE RUEDA		No. Lusac: 370077 Producto: CILINDRO DE RUEDA		No. Lusac: 370080 Producto: CILINDRO DE RUEDA	
					
DIAMETRO	7/8"	DIAMETRO	15/16"	DIAMETRO	13/16"
CHEVROLET TRACKER 99-08		DODGE RAM 3500 MAXI WAGON 00-02 RAM WAGON 1500 97-02 RAM VAN 1500 97-03 RAM WAGON 2500 98-02 RAM VAN 2500 98-03 RAM VAN 3500 00-02		FORD CONTOUR 96-00	
No. Lusac: 370081 Producto: CILINDRO DE RUEDA		No. Lusac: 370083 Producto: CILINDRO DE RUEDA		No. Lusac: 370087 Producto: CILINDRO DE RUEDA	
					
DIAMETRO	17.4 mm 11/16"	DIAMETRO	1"	DIAMETRO	7/8"
CHRYSLER NEON 00-02		NISSAN QUEST 99-02		HONDA ODYSSEY 99-01	

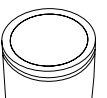

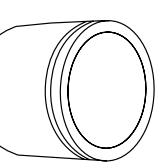

Fotografías de producto y especificaciones

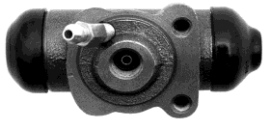
No. Lusac: 370088 Producto: CILINDRO DE RUEDA		No. Lusac: 370091 Producto: CILINDRO DE RUEDA		No. Lusac: 370092 Producto: CILINDRO DE RUEDA	
					
DIAMETRO	7/8"	DIAMETRO	7/8"	DIAMETRO	7/8"
HONDA ODYSSEY 99-01		FORD EXPLORER BASE SPORT 01-02 EXPLORER SPORT TRAC 01-03		FORD EXPLORER BASE SPORT 01-02 EXPLORER SPORT TRAC 01-03	
No. Lusac: 370093 Producto: CILINDRO DE RUEDA		No. Lusac: 370094 Producto: CILINDRO DE RUEDA		No. Lusac: 370103 Producto: CILINDRO DE RUEDA	
					
DIAMETRO	13/16"	DIAMETRO	15/16"	DIAMETRO	13/16"
FORD FOCUS 00-01		FORD MERCURY ESCAPE 01-08 MARINER 05-09		CHEVROLET SUZUKI AVEO 08-15 SWIFT SWIFT+ 05-10 SPARK 13-15 PONTIAC G3 07-09	
No. Lusac: 370105 Producto: CILINDRO DE RUEDA		No. Lusac: 370106 Producto: CILINDRO DE RUEDA		No. Lusac: 370111 Producto: CILINDRO DE RUEDA	
					
DIAMETRO	13/16"	DIAMETRO	15/16"	DIAMETRO	7/8"
JEEP LIBERTY 02		NISSAN ALTIMA 96-01		TOYOTA CAMRY LE, XLE, 00-06	

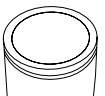

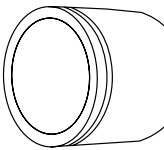



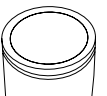

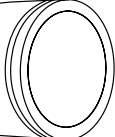
No. Lusac: 370112 Producto: CILINDRO DE RUEDA		No. Lusac: 370113 Producto: CILINDRO DE RUEDA		No. Lusac: 370115 Producto: CILINDRO DE RUEDA	
					
DIAMETRO	19.0 mm 3/4"	DIAMETRO	19.0 mm 3/4"	DIAMETRO	13/16"
TOYOTA MATRIX XR 03-08		VOLKSWAGEN DERBY 03-09 JETTA CLÁSICO 10-14		VOLKSWAGEN JETTA A4 08-10 JETTA CLASICO 11-15 SAVEIRO 10-11	
No. Lusac: 370117 Producto: CILINDRO DE RUEDA		No. Lusac: 370121 Producto: CILINDRO DE RUEDA		No. Lusac: 370123 Producto: CILINDRO DE RUEDA	
					
DIAMETRO	7/8"	DIAMETRO	7/8"	DIAMETRO	13/16"
PONTIAC AZTEK 01-05		FORD FOCUS LX 05-07		HONDA ACCORD EX 03-07 CIVIC 03-06	
No. Lusac: 370127 Producto: CILINDRO DE RUEDA		No. Lusac: 370129 Producto: CILINDRO DE RUEDA		No. Lusac: 370130 Producto: CILINDRO DE RUEDA	
					
DIAMETRO	13/16"	DIAMETRO	13/16"	DIAMETRO	7/8"
HONDA ACCORD EX 03-07 CIVIC 03-06		MITSUBISHI OUTLANDER 03-06		CHEVROLET EQUINOX 05-06 PONTIAC TORRENT 06	



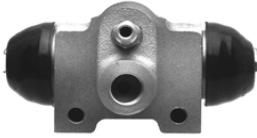
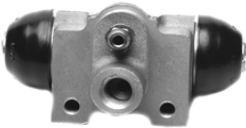
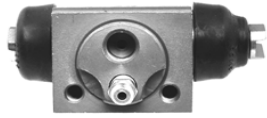
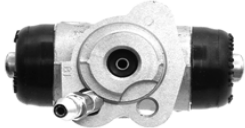

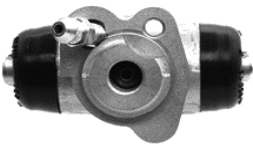

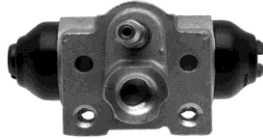

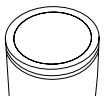

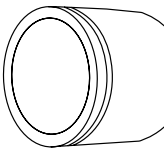

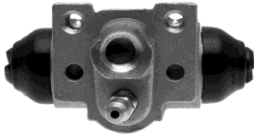
Fotografías de producto y especificaciones

No. Lusac: 370131 Producto: CILINDRO DE RUEDA 		No. Lusac: 370132 Producto: CILINDRO DE RUEDA 		No. Lusac: 370133 Producto: CILINDRO DE RUEDA 	
DIAMETRO	3/4"	DIAMETRO	3/4"	DIAMETRO	1 1/16"
HONDA CIVIC 02		HONDA CIVIC 02		CHEVROLET CAVALIER 03-04 PONTIAC SUNFIRE 03-05 TOYOTA TACOMA 06-14	
No. Lusac: 370139 Producto: CILINDRO DE RUEDA 		No. Lusac: 370142 Producto: CILINDRO DE RUEDA 		No. Lusac: 370143 Producto: CILINDRO DE RUEDA 	
DIAMETRO	3/4"	DIAMETRO	15.8 mm 5/8"	DIAMETRO	7/8"
TOYOTA COROLLA CE, LE 03-08 YARIS HATCH BACK 04-14 PRIUS 04-09		NISSAN SENTRA XE, GXE 02		TOYOTA HIACE 06-13 TACOMA 05-14 SIENNA 04-10	
No. Lusac: 370146 Producto: CILINDRO DE RUEDA 		No. Lusac: 370148 Producto: CILINDRO DE RUEDA 		No. Lusac: 370149 Producto: CILINDRO DE RUEDA 	
DIAMETRO	3/4"	DIAMETRO	1 5/16"	DIAMETRO	3/4"
TOYOTA COROLLA CE, LE 03-08 YARIS HATCH BACK 04-14 PRIUS 04-09		CHEVROLET COLORADO 04-12 GMC CANYON 07-10		HONDA CIVIC 99-00 02-05	



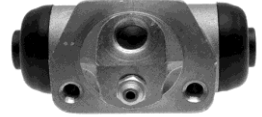

No. Lusac: 370152 Producto: CILINDRO DE RUEDA		No. Lusac: 370153 Producto: CILINDRO DE RUEDA		No. Lusac: 370154 Producto: CILINDRO DE RUEDA	
					
DIAMETRO	3/4"	DIAMETRO	7/8"	DIAMETRO	7/8"
HONDA CIVIC 99-00 02-05		SUZUKI GRAND VITARA GL, GLS 06-11, 99-05		NISSAN PATHFINDER 02-04	
No. Lusac: 370155 Producto: CILINDRO DE RUEDA		No. Lusac: 370157 Producto: CILINDRO DE RUEDA		No. Lusac: 370158 Producto: CILINDRO DE RUEDA	
					
DIAMETRO	3/4"	DIAMETRO	15.8 mm 5/8"	DIAMETRO	7/8"
MITSUBISHI LANCER 04-05 04-10		NISSAN SENTRA XE, GXE 01-06		NISSAN FRONTIER 98-02 01-02	
No. Lusac: 370159 Producto: CILINDRO DE RUEDA		No. Lusac: 370174 Producto: CILINDRO DE RUEDA		No. Lusac: 370176 Producto: CILINDRO DE RUEDA	
					
DIAMETRO	7/8"	DIAMETRO	7/8"	DIAMETRO	13/16"
SUZUKI GRAND VITARA GL, GLS 06-11 99-05		TOYOTA CAMRY LE, XLE 00-06		CHRYSLER PT CRUISER 05-10	

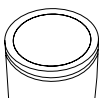

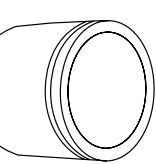

Fotografías de producto y especificaciones

No. Lusac: 370177 Producto: CILINDRO DE RUEDA 		No. Lusac: 370180 Producto: CILINDRO DE RUEDA 		No. Lusac: 370181 Producto: CILINDRO DE RUEDA 	
DIAMETRO	26.9 mm 1-1/16"	DIAMETRO	15/16"	DIAMETRO	26.9 mm 1-1/16"
DODGE DAKOTA LARAMIE 05-11		CHEVROLET GMC SILVERADO 2500, CHEYENNE 02 SIERRA 1500 CLASSIC 07-07		CHEVROLET GMC SILVERADO 1500 03-06 SIERRA 1500 CLASSIC 05-07 SILVERADO 2500 CHEYENNE 02	
No. Lusac: 370182 Producto: CILINDRO DE RUEDA 		No. Lusac: 370183 Producto: CILINDRO DE RUEDA 		No. Lusac: 370185 Producto: CILINDRO DE RUEDA 	
DIAMETRO	3/4"	DIAMETRO	15/16"	DIAMETRO	19.0 mm 3/4"
HONDA CIVIC EX 06-13 FIT 06-14		TOYOTA TACOMA 05-14		FORD RANGER 01-06	
No. Lusac: 370186 Producto: CILINDRO DE RUEDA 		No. Lusac: 370187 Producto: CILINDRO DE RUEDA 		No. Lusac: 370189 Producto: CILINDRO DE RUEDA 	
DIAMETRO	13/16"	DIAMETRO	7/8"	DIAMETRO	30.1 mm 1-3/16"
CHEVROLET COBALT 05-08 HHR 06-09		CHEVROLET MALIBU LX, LS 05-08		CHEVROLET GMC BLAZER 92-94 YUKON 92-00 C1500 88-99 TAHOE 95-01	

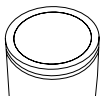

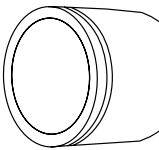



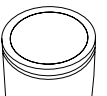

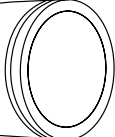

<p>No. Lusac: 370190 Producto: CILINDRO DE RUEDA</p> 		<p>No. Lusac: 370191 Producto: CILINDRO DE RUEDA</p> 		<p>No. Lusac: 370194 Producto: CILINDRO DE RUEDA</p> 	
DIAMETRO	15/16"	DIAMETRO	13/16"	DIAMETRO	11/16"
<p>CADILLAC OLDSMOBILE</p> <p>DEVILLE 02 SILHOUETTE 93, 96-04</p> <p>CHEVROLET PONTIAC</p> <p>VENTURE 05 MONTANA SV6 05</p>		<p>BUICK OLDSMOBILE</p> <p>LESABRE 92-95 EIGHTY EIGHT 92-95</p> <p>CADILLAC PARK AVENUE 91-95</p> <p>CONCOURS 91-02 SILHOUETTE 92-04</p> <p>DEVILLE 91-02 PONTIAC</p> <p>FLEETWOOD 91-92 BONNEVILLE 91-95</p> <p>CHEVROLET</p> <p>LUMINA 92-96</p>		<p>DODGE</p> <p>ATTITUDE GL, GLS 06-11</p>	
<p>No. Lusac: 370195 Producto: CILINDRO DE RUEDA</p> 		<p>No. Lusac: 370197 Producto: CILINDRO DE RUEDA</p> 		<p>No. Lusac: 370200 Producto: CILINDRO DE RUEDA</p> 	
DIAMETRO	3/4"	DIAMETRO	13/16"	DIAMETRO	1 1/16"
<p>CHRYSLER</p> <p>PT CRUISER 01-03 01-03</p>		<p>CHRYSLER JEEP</p> <p>SEBRING 07-09 PATRIOT SPORT, LIMITED 07-14</p> <p>DODGE</p> <p>AVENGER SE, SXT SPORT 08-10</p> <p>CALIBER 07-12</p>		<p>CHEVROLET</p> <p>SILVERADO 1500 14</p>	
<p>No. Lusac: 370201 Producto: CILINDRO DE RUEDA</p> 		<p>No. Lusac: 370211 Producto: CILINDRO DE RUEDA</p> 		<p>No. Lusac: 370212 Producto: CILINDRO DE RUEDA</p> 	
DIAMETRO	15/16"	DIAMETRO	15/16"	DIAMETRO	3/4"
<p>CHEVROLET GMC</p> <p>COLORADO 09-12 CANYON 09-12</p> <p>SILVERADO 1500 14</p>		<p>FORD MERCURY</p> <p>ESCAPE 09-12 MARINER 10-11</p>		<p>NISSAN</p> <p>SENTRA 07-12</p>	











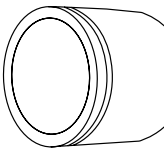



Fotografías de producto y especificaciones

No. Lusac: 370213 Producto: CILINDRO DE RUEDA		No. Lusac: 370214 Producto: CILINDRO DE RUEDA		No. Lusac: 370225 Producto: CILINDRO DE RUEDA	
					
DIAMETRO	1 1/16"	DIAMETRO	15.8 mm 5/8"	DIAMETRO	19.0 mm 3/4"
NISSAN TIIDA 07-12		NISSAN SENTRA 07-11 TIIDA 07-11		FORD FIESTA TREND 11-14	
No. Lusac: 370226 Producto: CILINDRO DE RUEDA		No. Lusac: 370239 Producto: CILINDRO DE RUEDA		No. Lusac: 370240 Producto: CILINDRO DE RUEDA	
					
DIAMETRO	13/16"	DIAMETRO	30.1 mm 1-3/16"	DIAMETRO	30.1 mm 1-3/16"
CHEVROLET CRUZE 10-14 SONIC 12-14		ISUZU ELF-400 07-11		ISUZU ELF-400 07-11	
No. Lusac: 370247 Producto: CILINDRO DE RUEDA		No. Lusac: 370254 Producto: CILINDRO DE RUEDA		No. Lusac: 370301 Producto: CILINDRO DE RUEDA	
					
DIAMETRO	30.1 mm 1-3/16"	DIAMETRO	19.00 mm 3/4"	DIAMETRO	19.0 mm 3/4"
ISUZU ELF-400 07-11		NISSAN MARCH 12-14 VERSA 12-14		VOLKSWAGEN POINTER CITY MI, VAGONETA 02-09	







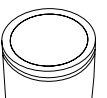

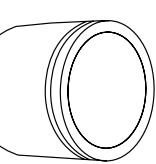

No. Lusac: 370382 Producto: CILINDRO DE RUEDA		No. Lusac: 370384 Producto: CILINDRO DE RUEDA		No. Lusac: 3700900 Producto: CILINDRO DE RUEDA	
					
DIAMETRO	22.0 mm	DIAMETRO	22.0 mm	DIAMETRO	19.0 mm 3/4"
CHEVROLET CHEVY PICKUP 99-04		CHEVROLET CHEVY PICKUP 99-04		FIAT PALIO 04-11 FORD FIESTA FIRST, TREND 98-10 IKON 01-07 KA INCLUYE SPORT 01-08	
No. Lusac: 3700901 Producto: CILINDRO DE RUEDA		No. Lusac: 3700902 Producto: CILINDRO DE RUEDA		No. Lusac: 3700904 Producto: CILINDRO DE RUEDA	
					
DIAMETRO	22.2 mm 7/8"	DIAMETRO	22.2 mm 7/8"	DIAMETRO	22.2 mm 7/8"
FORD LOBO 01-02		FORD LOBO 01-02		FORD COURIER PICKUP 01-10	
No. Lusac: 3700905 Producto: CILINDRO DE RUEDA		No. Lusac: 3700908 Producto: CILINDRO DE RUEDA		No. Lusac: 3700912 Producto: CILINDRO DE RUEDA	
					
DIAMETRO	19.0 mm 3/4"	DIAMETRO	19.0 mm 3/4"	DIAMETRO	22.2 mm 7/8"
CHRYSLER STRATUS 95-00		FORD ECOSPORT 04-10		RENAULT KANGOO 04-09	









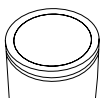

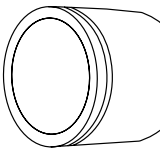

Fotografías de producto y especificaciones

No. Lusac: 3700913 Producto: CILINDRO DE RUEDA		No. Lusac: 3700914 Producto: CILINDRO DE RUEDA		No. Lusac: 3700915 Producto: CILINDRO DE RUEDA	
					
DIAMETRO	22.2 mm 7/8"	DIAMETRO	17.4 mm 11/16"	DIAMETRO	22.2 mm 7/8"
PEUGEOT PARTNER 04-09		CHEVROLET MATIZ 04-11		CHEVROLET MALIBU LX, LS 06-07	
No. Lusac: 3700916 Producto: CILINDRO DE RUEDA		No. Lusac: 3700917 Producto: CILINDRO DE RUEDA		No. Lusac: 3700920 Producto: CILINDRO DE RUEDA	
					
DIAMETRO	22.2 mm 7/8"	DIAMETRO	17.4 mm 11/16"	DIAMETRO	17.4 mm 11/16"
CHEVROLET TORNADO 04-08		DODGE H100 CHASIS VAN WAGON 06-11		DODGE H100 CHASIS VAN WAGON 06-11	
No. Lusac: 3700921 Producto: CILINDRO DE RUEDA					
					
DIAMETRO	22.2 mm 7/8"				
DODGE H100 VAN DIESEL VAN DIESEL 10-11					







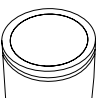

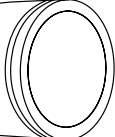



<p>No. Lusac: 1197</p> <p>Producto: MANGUERA DE FRENOS</p> 		<p>No. Lusac: 1208</p> <p>Producto: MANGUERA DE FRENOS</p> 		<p>No. Lusac: 1211</p> <p>Producto: MANGUERA DE FRENOS</p> 	
DIAMETRO	14 11/16"	DIAMETRO	17 1/4"	DIAMETRO	12 7/8"
<p>CHEVROLET</p> <p>C20 79-86 P30 PANEL 90-92 97-98</p>		<p>NISSAN</p> <p>PICKUP NISSAN 80-94</p>		<p>NISSAN</p> <p>PICKUP NISSAN 80-86</p>	
<p>No. Lusac: 2025</p> <p>Producto: MANGUERA DE FRENOS</p> 		<p>No. Lusac: 4013</p> <p>Producto: MANGUERA DE FRENOS</p> 		<p>No. Lusac: 4034</p> <p>Producto: MANGUERA DE FRENOS</p> 	
DIAMETRO	8"	DIAMETRO	15 3/4"	DIAMETRO	19 7/8"
<p>BUICK</p> <p>CENTURY 83-96</p> <p>CHEVROLET</p> <p>CELEBRITY 85-89 CITATION 82-85 82-85</p>		<p>OLDSMOBILE</p> <p>CUTLASS 87-96 EUROSPORT 91-96 SILHOUETTE 91-92 94-95</p>		<p>DODGE</p> <p>D150 83-93 D250 86-93 D350 88-93</p> <p>RAM CHARGER 86-93 95-96</p>	
<p>FORD</p> <p>F150 84-91 F200 86-86</p>		<p>No. Lusac: 4035</p> <p>Producto: MANGUERA DE FRENOS</p> 		<p>No. Lusac: 4036</p> <p>Producto: MANGUERA DE FRENOS</p> 	
DIAMETRO	19 3/4"	DIAMETRO	18 1/2"	DIAMETRO	16"
<p>FORD</p> <p>F150 84-91 F200 86-86</p>		<p>FORD</p> <p>F200 87-91 86-91 F250 92-94</p>		<p>BUICK</p> <p>CENTURY 83-86</p>	









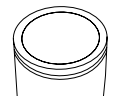

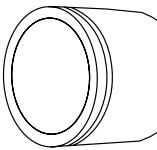



Fotografías de producto y especificaciones

No. Lusac: 4051 Producto: MANGUERA DE FRENOS 		No. Lusac: 4062 Producto: MANGUERA DE FRENOS 		No. Lusac: 4063 Producto: MANGUERA DE FRENOS 	
DIAMETRO	16 1/16"	DIAMETRO	16 1/2"	DIAMETRO	16 5/8"
BUICK CENTURY 83-96 CHEVROLET CELEBRITY 85-89 CITATION 82-85		OLDSMOBILE CUTLASS 87-96 EUROSPOK 91-96		FORD GHIA 91-94 TOPAZ 84-94	
No. Lusac: 4068 Producto: MANGUERA DE FRENOS 		No. Lusac: 4072 Producto: MANGUERA DE FRENOS 		No. Lusac: 4073 Producto: MANGUERA DE FRENOS 	
DIAMETRO	17 5/8"	DIAMETRO	21 1/4"	DIAMETRO	21 1/4"
BUICK CENTURY 87-96 CHEVROLET CELEBRITY 85-89 CITATION 82-85		OLDSMOBILE CUTLASS 87-96 EUROSPOK 91-96 SILHOUETTE 91		CHRYSLER LE BARON K 83-87 NEW YORKER 85-89 PHANTOM 87-89	
		DODGE SERIE 600K 84-85 SHADOW GTS 89 SPIRIT 90		CHRYSLER LE BARON K 83-87 NEW YORKER 85-89 PHANTOM 87-89	
		DODGE SERIE 600K 84-85 SHADOW GTS 89 SPIRIT 90-90			
No. Lusac: 4222 Producto: MANGUERA DE FRENOS 		No. Lusac: 4223 Producto: MANGUERA DE FRENOS 		No. Lusac: 5021 Producto: MANGUERA DE FRENOS 	
DIAMETRO	13"	DIAMETRO	12"	DIAMETRO	14 7/8"
CHEVROLET CAVALIER Z2490-91		CHEVROLET CAVALIER Z24 90-91		FORD GRAND MARQUIS 95-97	







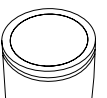

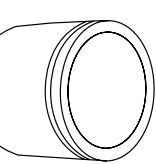



No. Lusac: 6024 Producto: MANGUERA DE FRENOS		No. Lusac: 6027 Producto: MANGUERA DE FRENOS		No. Lusac: 6031 Producto: MANGUERA DE FRENOS	
					
DIAMETRO	11"	DIAMETRO	15 1/16"	DIAMETRO	13 1/4"
VOLKSWAGEN COMBI 90-01 PANEL 99-01		VOLKSWAGEN SEDAN 83-04 83-04		VOLKSWAGEN ATLANTIC 81-87 CARIBE 78-87 CORSAR 84-88 GOLF A2 GTI 87-92 JETTA A2 A2 88-99	
No. Lusac: 7010 Producto: MANGUERA DE FRENOS		No. Lusac: 36824 Producto: MANGUERA DE FRENOS		No. Lusac: 36954 Producto: MANGUERA DE FRENOS	
					
DIAMETRO	13 1/4"	DIAMETRO	8.88"	DIAMETRO	23.25"
VOLKSWAGEN COMBI 90-01 PANEL 90-01		FORD MONDEO SPORT XLS 03-04 MONTERO SPORT 97-04 MITSUBISHI MONTERO 92-00		CHEVROLET P30 PANEL 90-92 97-98	
No. Lusac: 36957 Producto: MANGUERA DE FRENOS		No. Lusac: 38002 Producto: MANGUERA DE FRENOS		No. Lusac: 38009 Producto: MANGUERA DE FRENOS	
					
DIAMETRO	23.16"	DIAMETRO	8.88"	DIAMETRO	22"
CHEVROLET C30 84-86 C3500 89-89 MICROBUS 88-93		VOLVO C70 98-04 S70 99-00 V70 98-04 99-04		NISSAN PICKUP NISSAN 95-97	









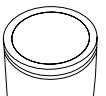

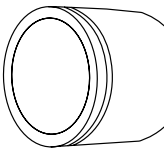



Fotografías de producto y especificaciones

No. Lusac: 38011 Producto: MANGUERA DE FRENOS 		No. Lusac: 38014 Producto: MANGUERA DE FRENOS 		No. Lusac: 38049 Producto: MANGUERA DE FRENOS 	
DIAMETRO	10.25"	DIAMETRO	11.16"	DIAMETRO	11.88"
NISSAN SENTRA 92		NISSAN TSURU GSR 2000 III GS 95-15		DODGE W250 89-93	
No. Lusac: 38050 Producto: MANGUERA DE FRENOS 		No. Lusac: 38059 Producto: MANGUERA DE FRENOS 		No. Lusac: 38061 Producto: MANGUERA DE FRENOS 	
DIAMETRO	12"	DIAMETRO	20.75"	DIAMETRO	19.5"
DODGE W250 89-93		CHEVROLET BLAZER NEVADA 91		CHEVROLET BLAZER NEVADA 91	
No. Lusac: 38064 Producto: MANGUERA DE FRENOS 		No. Lusac: 38068 Producto: MANGUERA DE FRENOS 		No. Lusac: 38081 Producto: MANGUERA DE FRENOS 	
DIAMETRO	8.25"	DIAMETRO	18.25"	DIAMETRO	7.5"
CHRYSLER NEW YORKER 85-89 PHANTOM 87-89		DODGE SERIE 600K 84-85 SHADOW GTS 89		CHEVROLET CHEVY VAN 95	
				CADILLAC ELDORADO 98-02 SEVILLE 96-97	
				PONTIAC SUNFIRE 96-05	
				CHEVROLET CAVALIER Z24 90-04	







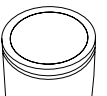

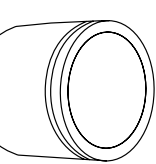



<p>No. Lusac: 38082</p> <p>Producto: MANGUERA DE FRENOS</p> 		<p>No. Lusac: 38168</p> <p>Producto: MANGUERA DE FRENOS</p> 		<p>No. Lusac: 38182</p> <p>Producto: MANGUERA DE FRENOS</p> 	
DIAMETRO	25.38"	DIAMETRO	7.38"	DIAMETRO	23.94"
<p>DODGE</p> <p>RAM VAN 1500 95-97 RAM WAGON 2500 96-97</p> <p>RAM VAN 2500 96-97</p> <p>RAM WAGON 1500 95-97</p>		<p>VOLKSWAGEN</p> <p>GOLF A2 89-92 GTI 89-92 A3 93-98 GTI 96-98</p> <p>JETTA A3 VR6 93-98</p>		<p>CHEVROLET</p> <p>CHEVY VAN 95-95</p>	
<p>No. Lusac: 38183</p> <p>Producto: MANGUERA DE FRENOS</p> 		<p>No. Lusac: 38197</p> <p>Producto: MANGUERA DE FRENOS</p> 		<p>No. Lusac: 38200</p> <p>Producto: MANGUERA DE FRENOS</p> 	
DIAMETRO	23.19"	DIAMETRO	23"	DIAMETRO	23"
<p>CHEVROLET</p> <p>CHEVY VAN 95-95</p>		<p>DODGE</p> <p>RAM VAN 1500 95-97 RAM WAGON 2500 96-97</p> <p>RAM VAN 2500 96-97</p> <p>RAM WAGON 1500 95-97</p>		<p>DODGE</p> <p>D350 81-87 RAM VAN 3500 95-97</p> <p>RAM 3500 MAXI WAGON 95-97 RAM WAGON 1500 95-97</p> <p>RAM VAN 1500 95-97 RAM WAGON 2500 96-97</p> <p>RAM VAN 2500 96-97</p>	
<p>No. Lusac: 38218</p> <p>Producto: MANGUERA DE FRENOS</p> 		<p>No. Lusac: 38243</p> <p>Producto: MANGUERA DE FRENOS</p> 		<p>No. Lusac: 38244</p> <p>Producto: MANGUERA DE FRENOS</p> 	
DIAMETRO	10.81"	DIAMETRO	26.13"	DIAMETRO	12.44"
<p>HONDA</p> <p>CIVIC 97-01 97-01</p>		<p>DODGE</p> <p>D150 83-90 W150 85-87</p> <p>D250 86-87 W250 86-93</p> <p>RAM CHARGER 86-93 95-96</p>		<p>DODGE</p> <p>W250 86-88</p>	









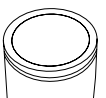

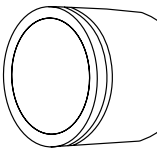



Fotografías de producto y especificaciones

No. Lusac: 38253		No. Lusac: 38259		No. Lusac: 38260	
Producto: MANGUERA DE FRENOS		Producto: MANGUERA DE FRENOS		Producto: MANGUERA DE FRENOS	
					
DIAMETRO	18.25"	DIAMETRO	10.38"	DIAMETRO	13"
CADILLAC DEVILLE CONCOURS 91-96		CHRYSLER 300C 05		FORD THUNDERBIRD 85-86 89	
OLDSMOBILE EIGHTY EIGHT 92		RENAULT ENCORE 85-86			
No. Lusac: 38262		No. Lusac: 38264		No. Lusac: 38267	
Producto: MANGUERA DE FRENOS		Producto: MANGUERA DE FRENOS		Producto: MANGUERA DE FRENOS	
					
DIAMETRO	18.31"	DIAMETRO	11.38"	DIAMETRO	11.38"
CADILLAC DEVILLE CONCOURS 91-96		CHEVROLET C3500 90 SILVERADO 3500 01-02		CHEVROLET C3500 90 SILVERADO 3500 01-02 C3500HD SILVERADO CLASSIC 99	
OLDSMOBILE EIGHTY EIGHT 92					
No. Lusac: 38328		No. Lusac: 38338		No. Lusac: 38353	
Producto: MANGUERA DE FRENOS		Producto: MANGUERA DE FRENOS		Producto: MANGUERA DE FRENOS	
					
DIAMETRO	10.5"	DIAMETRO	16.5"	DIAMETRO	15.88"
CHRYSLER SEBRING 00-05 STRATUS 98-06 DODGE AVENGER 95-00		MITSUBISHI ECLIPSE GT GT 95-05 GALANT DE 00-03		FORD AEROSTAR 91-95	
				BMW Z3 98-02	







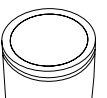

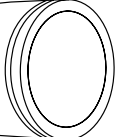



No. Lusac: 38372		No. Lusac: 38378		No. Lusac: 38382	
Producto: MANGUERA DE FRENOS		Producto: MANGUERA DE FRENOS		Producto: MANGUERA DE FRENOS	
					
DIAMETRO	9.63"	DIAMETRO	10.75"	DIAMETRO	16.69"
FORD		FORD		FORD MERCURY	
MUSTANG GT 94-95		GHIA 91-94 TOPAZ 84-94		TAURUS 88-91 SABLE VAGONETA 94-97	
No. Lusac: 38387		No. Lusac: 38421		No. Lusac: 38481	
Producto: MANGUERA DE FRENOS		Producto: MANGUERA DE FRENOS		Producto: MANGUERA DE FRENOS	
					
DIAMETRO	13.69"	DIAMETRO	10.19"	DIAMETRO	20.94"
LINCOLN		DODGE		NISSAN	
MARK VIII 94-96		W150 85-87 W250 86-88		PICKUP NISSAN 93-97 92-92	
No. Lusac: 38491		No. Lusac: 38494		No. Lusac: 38496	
Producto: MANGUERA DE FRENOS		Producto: MANGUERA DE FRENOS		Producto: MANGUERA DE FRENOS	
					
DIAMETRO	15.75"	DIAMETRO	15.75"	DIAMETRO	20.63"
NISSAN		NISSAN		NISSAN	
PICKUP NISSAN DOBLE CABINA 80-97		PICKUP NISSAN DOBLE CABINA 82-97		TSURU II II III GS 88-15	









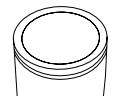

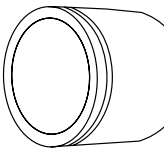



Fotografías de producto y especificaciones

No. Lusac: 38506 Producto: MANGUERA DE FRENOS 		No. Lusac: 38514 Producto: MANGUERA DE FRENOS 		No. Lusac: 38552 Producto: MANGUERA DE FRENOS 	
DIAMETRO	10.38"	DIAMETRO	11.94"	DIAMETRO	12.75"
FORD THUNDERBIRD 87-89 89-89		MERCEDEZ BENZ C220 95 S80 99-06 C280 VAGONETA 98-00 V70 T5 06 C43AMG 98-00 XC70 03-07 VOLVO S60 2.4 T5 01-02 07		BMW 525I 06-07 745I 02-05 528IA 08-10 745LI 03-08 530I 04-07 750I 06-08 535I 08-12 750LI 06-08 545I 04-05 760LI 03-08 550I BASE 06-10 M5 06-11 645CI 05-09 M6 06-11 650CI 06-09 650I 06-12	
No. Lusac: 38572 Producto: MANGUERA DE FRENOS 		No. Lusac: 38576 Producto: MANGUERA DE FRENOS 		No. Lusac: 38587 Producto: MANGUERA DE FRENOS 	
DIAMETRO	23.63"	DIAMETRO	21.88"	DIAMETRO	18.11"
CHEVROLET MICROBUS 92-98 SUBURBAN 90-98		DODGE RAM 1500 98-99 RAM VAN 3500 00-01 RAM 2500 98-99 RAM 3500 MAXI WAGON 00-01		BUICK CHEVROLET REGAL 94-96 LUMINA 90-94 97-01	
No. Lusac: 38588 Producto: MANGUERA DE FRENOS 		No. Lusac: 38604 Producto: MANGUERA DE FRENOS 		No. Lusac: 38605 Producto: MANGUERA DE FRENOS 	
DIAMETRO	17.88"	DIAMETRO	6.88"	DIAMETRO	17.25"
BUICK CHEVROLET REGAL 94-96 LUMINA 97-01		CHRYSLER DODGE IMPERIAL 91 SHADOW GTS 89 LE BARON 92-95 SPIRIT RT 91-92 NEW YORKER 90-94 PHANTOM 90-94		CHRYSLER VOYAGER 87-91 B350 87 DODGE CARAVAN 87-91 B150 87	







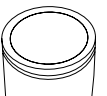

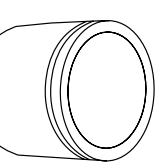

No. Lusac: 38607		No. Lusac: 38608		No. Lusac: 38609	
Producto: MANGUERA DE FRENOS		Producto: MANGUERA DE FRENOS		Producto: MANGUERA DE FRENOS	
					
DIAMETRO	19.56"	DIAMETRO	19.44"	DIAMETRO	19.75"
MERCURY		MERCURY		FORD	
SABLE VAGONETA 94-95		SABLE VAGONETA 94-95		THUNDERBIRD 90-92	
No. Lusac: 38610		No. Lusac: 38614		No. Lusac: 38615	
Producto: MANGUERA DE FRENOS		Producto: MANGUERA DE FRENOS		Producto: MANGUERA DE FRENOS	
					
DIAMETRO	19.75"	DIAMETRO	12.88"	DIAMETRO	12.88"
FORD		CHEVROLET		CHEVROLET	
THUNDERBIRD 90-92		CORVETTE 91-92		CORVETTE 91-92	
No. Lusac: 38616		No. Lusac: 38617		No. Lusac: 38618	
Producto: MANGUERA DE FRENOS		Producto: MANGUERA DE FRENOS		Producto: MANGUERA DE FRENOS	
					
DIAMETRO	21.5"	DIAMETRO	30.13"	DIAMETRO	11.94"
CHEVROLET		CHEVROLET		CHEVROLET SUZUKI	
TRACKER 98-99		TRACKER 98-99		TRACKER 98-99 GRAND VITARA 06-08	









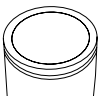



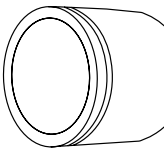

Fotografías de producto y especificaciones

No. Lusac: 38620		No. Lusac: 38621		No. Lusac: 38622	
Producto: MANGUERA DE FRENOS		Producto: MANGUERA DE FRENOS		Producto: MANGUERA DE FRENOS	
					
DIAMETRO	25.13"	DIAMETRO	25.13"	DIAMETRO	25.75"
CHEVROLET C1500 88-91 94-99 TAHOE 00-00 C2500 CHEYENNE 95-99 SUBURBAN 1500 00-01		CHEVROLET C1500 88-91 94-99 TAHOE 00-00 C2500 CHEYENNE 95-99 SUBURBAN 1500 00-01		CHEVROLET K20 88-95 SUBURBAN K20 89-95 K25 88-95	
No. Lusac: 38624		No. Lusac: 38636		No. Lusac: 38637	
Producto: MANGUERA DE FRENOS		Producto: MANGUERA DE FRENOS		Producto: MANGUERA DE FRENOS	
					
DIAMETRO	17.75"	DIAMETRO	22.13"	DIAMETRO	16.38"
CADILLAC ESCALADE 99-00 P30 PANEL 01-01 CHEVROLET SUBURBAN 1500 00 2500 00-02 C1500 88-91 94-99 TAHOE 00-00 C2500 CHEYENNE CLASSIC K2500 SILVERADO 99-00 GMC C3500 SILVERADO CLASSIC 89-99 SAVANA 1500 96-02 C3500HD SILVERADO CLASSIC 96-99 SAVANA 2500 EXT 96-02 EXPRESS 1500 96-02 20-02 2500-02 SIERRA 2500 99-00 EXPRESS 2500 CARGO VAN EXT 04-06 96-99 SIERRA K2500 CLASSIC 99-00 EXPRESS 3500 CARGO VAN EXT 96-02		DODGE D250 91-92 RAM 4000 99 DAKOTA 96 RAM SRT-10 05-06 RAM 1500 94-97 RAM VAN 3500 95-99 RAM 2500 94-97 RAM 3500 MAXI WAGON 94-99		OLDSMOBILE SILHOUETTE 91	



Fotografías de producto y especificaciones





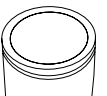

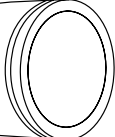



No. Lusac: 38646		No. Lusac: 38655		No. Lusac: 38656	
Producto: MANGUERA DE FRENOS		Producto: MANGUERA DE FRENOS		Producto: MANGUERA DE FRENOS	
					
DIAMETRO	9.38"	DIAMETRO	12"	DIAMETRO	11.88"
CHRYSLER		CHEVROLET		CHEVROLET	
DODGE		CORVETTE 91-92		CORVETTE 91-92	
TOWN & COUNTRY 94-95					
SHADOW 90-94					
VOYAGER 95					
SPIRIT 90-95					
No. Lusac: 38657		No. Lusac: 38658		No. Lusac: 38662	
Producto: MANGUERA DE FRENOS		Producto: MANGUERA DE FRENOS		Producto: MANGUERA DE FRENOS	
					
DIAMETRO	13.75"	DIAMETRO	9.5"	DIAMETRO	22.25"
CHEVROLET		CADILLAC		CHEVROLET	
SAAB		CATERA 97-01		C3500 89-89	
CHEVY C2 JOY MONZA, POP, VAGONETA, SWING 95-12		CHEVY PICKUP 99-03			
9-3 99-03					
CHEVY PICKUP 99-03 99-03					
DAEWOO		CHEVROLET			
LANOS 99-02		CHEVY C2 JOY MONZA, POP, VAGONETA, SWING 95-12			
No. Lusac: 38663		No. Lusac: 38664		No. Lusac: 38665	
Producto: MANGUERA DE FRENOS		Producto: MANGUERA DE FRENOS		Producto: MANGUERA DE FRENOS	
					
DIAMETRO	22.25"	DIAMETRO	19.5"	DIAMETRO	19.5"
CHEVROLET		CHEVROLET		CHEVROLET	
C3500 89		TAHOE 00		TAHOE 00	









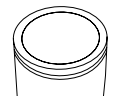



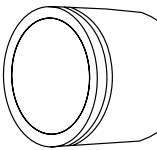

Fotografías de producto y especificaciones

No. Lusac: 38666 Producto: MANGUERA DE FRENOS 		No. Lusac: 38668 Producto: MANGUERA DE FRENOS 		No. Lusac: 38669 Producto: MANGUERA DE FRENOS 	
DIAMETRO	12.75"	DIAMETRO	20"	DIAMETRO	11.5"
FORD TAURUS 88-91		MERCURY SABLE VAGONETA 94-95		FORD THUNDERBIRD 90-92	
FORD TAURUS 88-91		MERCURY SABLE VAGONETA 94-95		FORD TAURUS 88-91	
No. Lusac: 38679 Producto: MANGUERA DE FRENOS 		No. Lusac: 38681 Producto: MANGUERA DE FRENOS 		No. Lusac: 38683 Producto: MANGUERA DE FRENOS 	
DIAMETRO	18"	DIAMETRO	15.75"	DIAMETRO	12.25"
CHEVROLET LUV 97-00		FORD TAURUS 88-91		MERCURY SABLE VAGONETA 94-97	
ISUZU PICKUP ISUZU 88-95		MERCURY SABLE VAGONETA 94-97		NISSAN MAXIMA 91-93	
No. Lusac: 38684 Producto: MANGUERA DE FRENOS  Imagen Disponible Proximamente		No. Lusac: 38688 Producto: MANGUERA DE FRENOS 		No. Lusac: 38689 Producto: MANGUERA DE FRENOS 	
DIAMETRO	11.88"	DIAMETRO	23.38"	DIAMETRO	19.63"
NISSAN 300ZX 91-96		NISSAN 300ZX 91-96		NISSAN MAXIMA 91-93	



Fotografías de producto y especificaciones





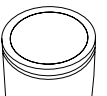

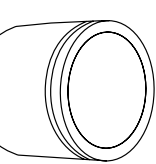

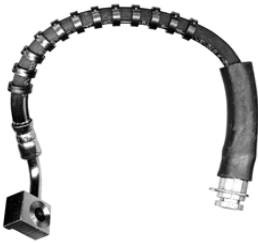

No. Lusac: 38696 Producto: MANGUERA DE FRENOS 		No. Lusac: 38697 Producto: MANGUERA DE FRENOS 		No. Lusac: 38701 Producto: MANGUERA DE FRENOS 	
DIAMETRO	21.75"	DIAMETRO	21.75"	DIAMETRO	21.5"
NISSAN 240SX 93		NISSAN 240SX 93		NISSAN MAXIMA 91-93	
No. Lusac: 38744 Producto: MANGUERA DE FRENOS 		No. Lusac: 38745 Producto: MANGUERA DE FRENOS 		No. Lusac: 38746 Producto: MANGUERA DE FRENOS 	
DIAMETRO	26.25"	DIAMETRO	25"	DIAMETRO	21.25"
DODGE D150 90-93 D350 90-93 D250 86-93		DODGE D250 86-87 RAM 4000 95-97 RAM 3500 95-97		CADILLAC DEVILLE HEAVY DUTY 91-93	
No. Lusac: 38747 Producto: MANGUERA DE FRENOS 		No. Lusac: 38808 Producto: MANGUERA DE FRENOS 		No. Lusac: 38813 Producto: MANGUERA DE FRENOS 	
DIAMETRO	21.25"	DIAMETRO	22.5"	DIAMETRO	19.9"
CADILLAC DEVILLE HEAVY DUTY 91-93		CHEVROLET C3500 SILVERADO CLASSIC 92-99 P30 PANEL 97-01 C3500HD 96-99 MICROBUS 94-96		FORD EXPLORER 91-94 B2500 98-01 RANGER 96-06 B3000 94-08 MAZDA B2300 01-10	









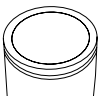

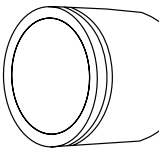

Fotografías de producto y especificaciones

No. Lusac: 38814 Producto: MANGUERA DE FRENOS		No. Lusac: 38815 Producto: MANGUERA DE FRENOS		No. Lusac: 38823 Producto: MANGUERA DE FRENOS	
					
DIAMETRO	14.19"	DIAMETRO	14.19"	DIAMETRO	22.38"
FORD AEROSTAR 91-95		FORD AEROSTAR 91-95		CHEVROLET C3500 SILVERADO CLASSIC 90-95 99 MICROBUS 92-96	
No. Lusac: 38824 Producto: MANGUERA DE FRENOS		No. Lusac: 38831 Producto: MANGUERA DE FRENOS		No. Lusac: 38832 Producto: MANGUERA DE FRENOS	
					
DIAMETRO	23.25"	DIAMETRO	27.88"	DIAMETRO	27.88"
CHEVROLET C3500 SILVERADO CLASSIC 92-99 C3500HD 96-99 MICROBUS 94-96 P30 PANEL PANEL 97-01		HONDA ACCORD 96-97		HONDA ACCORD 96-97	
No. Lusac: 38840 Producto: MANGUERA DE FRENOS		No. Lusac: 38842 Producto: MANGUERA DE FRENOS		No. Lusac: 38845 Producto: MANGUERA DE FRENOS	
					
DIAMETRO	11"	DIAMETRO	16.13"	DIAMETRO	17.31"
FORD ESCORT VAGONETA 94-02		FORD ESCORT GT VAGONETA 94-02		JEEP WRANGLER 93-95	

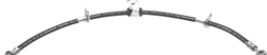





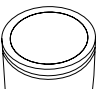

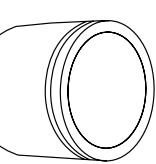



No. Lusac: 38847 Producto: MANGUERA DE FRENOS		No. Lusac: 38851 Producto: MANGUERA DE FRENOS		No. Lusac: 38852 Producto: MANGUERA DE FRENOS	
					
DIAMETRO	14.38"	DIAMETRO	19.63"	DIAMETRO	19.63"
JEEP CHEROKEE 90-91 WAGONEER 90		CHEVROLET GMC ASTRO 90-99 SAFARI 90-99		CHEVROLET GMC ASTRO 90-99 SAFARI 90-99	
No. Lusac: 38855 Producto: MANGUERA DE FRENOS		No. Lusac: 38857 Producto: MANGUERA DE FRENOS		No. Lusac: 38861 Producto: MANGUERA DE FRENOS	
					
DIAMETRO	26.25"	DIAMETRO	27"	DIAMETRO	20.75"
HONDA ACCORD 86-89		HONDA CIVIC 89-91		JEEP WRANGLER 93-95	
No. Lusac: 38862 Producto: MANGUERA DE FRENOS		No. Lusac: 38863 Producto: MANGUERA DE FRENOS		No. Lusac: 38864 Producto: MANGUERA DE FRENOS	
					
DIAMETRO	20.75"	DIAMETRO	18.13"	DIAMETRO	18.13"
JEEP WRANGLER 93-95		JEEP CHEROKEE 91-93 COMANCHE 91-92		JEEP CHEROKEE 91-93 COMANCHE 91-92	









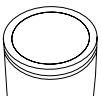

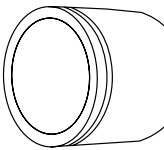



Fotografías de producto y especificaciones

No. Lusac: 38865 Producto: MANGUERA DE FRENOS		No. Lusac: 38866 Producto: MANGUERA DE FRENOS		No. Lusac: 38867 Producto: MANGUERA DE FRENOS	
					
DIAMETRO	20.13"	DIAMETRO	18.75"	DIAMETRO	21.50"
NISSAN SENTRA 92-92		NISSAN SENTRA 92-92		FORD F150 88-91	
No. Lusac: 38869 Producto: MANGUERA DE FRENOS		No. Lusac: 38870 Producto: MANGUERA DE FRENOS		No. Lusac: 38871 Producto: MANGUERA DE FRENOS	
					
DIAMETRO	21.88"	DIAMETRO	21.88"	DIAMETRO	18.88"
CHEVROLET BLAZER 95-97 S-10 95-97		CHEVROLET BLAZER 95-97 S-10 95-97		CHEVROLET ISUZU BLAZER 95-05 HOMBRE 98-00 S-10 95-04 OLDSMOBILE GMC BRAVADA 96-01 JIMMY 96-01 SONOMA 00-04	
No. Lusac: 38872 Producto: MANGUERA DE FRENOS		No. Lusac: 38873 Producto: MANGUERA DE FRENOS		No. Lusac: 38884 Producto: MANGUERA DE FRENOS	
					
DIAMETRO	25.88"	DIAMETRO	25.88"	DIAMETRO	17.63"
CHEVROLET C3500 91-99 C3500HD SILVERADO CLASSIC 96-99		CHEVROLET C3500 91-99 C3500HD SILVERADO CLASSIC 96-99		SATURN TODOS 91-02	







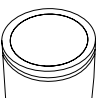

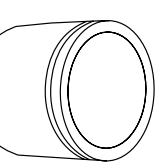



No. Lusac: 38890		No. Lusac: 38891		No. Lusac: 38892	
Producto: MANGUERA DE FRENOS		Producto: MANGUERA DE FRENOS		Producto: MANGUERA DE FRENOS	
					
DIAMETRO	17.38"	DIAMETRO	19.75"	DIAMETRO	29.5"
DODGE		DODGE		DODGE	
DAKOTA 91		DAKOTA 91		DAKOTA 91-96	
No. Lusac: 38893		No. Lusac: 38894		No. Lusac: 38895	
Producto: MANGUERA DE FRENOS		Producto: MANGUERA DE FRENOS		Producto: MANGUERA DE FRENOS	
					
DIAMETRO	29.5"	DIAMETRO	18.37"	DIAMETRO	18.37"
DODGE		JEEP		JEEP	
DAKOTA 91-96		CHEROKEE SPORT 94-08 WRANGLER 97-06 GRAND CHEROKEE 93-98		CHEROKEE SPORT SPORT 94-01 WRANGLER 97-06 GRAND CHEROKEE 93-98	
No. Lusac: 38897		No. Lusac: 38898		No. Lusac: 38899	
Producto: MANGUERA DE FRENOS		Producto: MANGUERA DE FRENOS		Producto: MANGUERA DE FRENOS	
					
DIAMETRO	18.75"	DIAMETRO	23.75"	DIAMETRO	20.88"
FORD		FORD		FORD	
F250 92-94		F200 89-91 F300 F350 90-94 F250 89-96		F150 92-96	









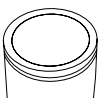

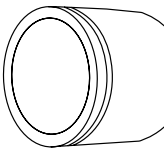



Fotografías de producto y especificaciones

No. Lusac: 38900 Producto: MANGUERA DE FRENOS 		No. Lusac: 38902 Producto: MANGUERA DE FRENOS 		No. Lusac: 38903 Producto: MANGUERA DE FRENOS 	
DIAMETRO	20.88"	DIAMETRO	15.5"	DIAMETRO	20.25"
FORD F150 92-96		LINCOLN TOWN CAR 95-96		FORD EXPLORER 91	
No. Lusac: 38904 Producto: MANGUERA DE FRENOS 		No. Lusac: 38905 Producto: MANGUERA DE FRENOS 		No. Lusac: 38906 Producto: MANGUERA DE FRENOS 	
DIAMETRO	20.25"	DIAMETRO	17.88"	DIAMETRO	17.88"
FORD EXPLORER 91		CHEVROLET CAVALIER Z24 92-94		CHEVROLET CAVALIER Z24 92-94	
No. Lusac: 38947 Producto: MANGUERA DE FRENOS 		No. Lusac: 38950 Producto: MANGUERA DE FRENOS 		No. Lusac: 38951 Producto: MANGUERA DE FRENOS 	
DIAMETRO	24.63"	DIAMETRO	24.63"	DIAMETRO	12.5"
FORD F450 SUPER DUTY SUPER DUTY XL 97-02		FORD F450 SUPER DUTY SUPER DUTY XL 97-02		CADILLAC DEVILLE CONCOURS CONCOURS 91-96 OLDSMOBILE EIGHTY EIGHT 92 94-95	
				PONTIAC BONNEVILLE 94-99	







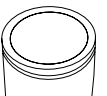

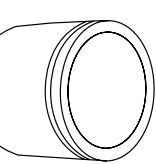



No. Lusac: 38961 Producto: MANGUERA DE FRENOS 		No. Lusac: 38962 Producto: MANGUERA DE FRENOS 		No. Lusac: 38963 Producto: MANGUERA DE FRENOS 	
DIAMETRO	13.88"	DIAMETRO	12.63"	DIAMETRO	12.25"
MERCURY SABLE VAGONETA 94-95		MERCURY SABLE VAGONETA 94-97		MERCURY SABLE VAGONETA 94-97	
No. Lusac: 38965 Producto: MANGUERA DE FRENOS 		No. Lusac: 38982 Producto: MANGUERA DE FRENOS 		No. Lusac: 38983 Producto: MANGUERA DE FRENOS 	
DIAMETRO	10.88"	DIAMETRO	21.63"	DIAMETRO	21.5"
LINCOLN TOWN CAR 91-94		INFINITI Q45 94-96		INFINITI Q45 94-96	
No. Lusac: 38986 Producto: MANGUERA DE FRENOS 		No. Lusac: 38997 Producto: MANGUERA DE FRENOS 		No. Lusac: 380006 Producto: MANGUERA DE FRENOS 	
DIAMETRO	11.5"	DIAMETRO	14"	DIAMETRO	14.5"
TOYOTA SEQUOIA 01-07 TACOMA PRE RUNNER 05-11 TUNDRA 00-06		FORD THUNDERBIRD 90-92		CADILLAC ESCALADE 07-10	









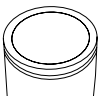



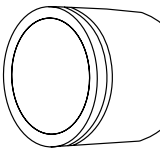

Fotografías de producto y especificaciones

No. Lusac: 380007 Producto: MANGUERA DE FRENOS 		No. Lusac: 380009 Producto: MANGUERA DE FRENOS 		No. Lusac: 380038 Producto: MANGUERA DE FRENOS 	
DIAMETRO	9.63"	DIAMETRO	14.5"	DIAMETRO	15"
AUDI A4 AVANT 97-01 S4 00-01		CHRYSLER STRATUS 95-00		MERCEDEZ BENZ E430 99-02 G55AMG 09-11 S500L 94 SL320 95-97 SL500 95-02 SL600 95-02	
JEEP CHEROKEE SPORT SPORT 94-01					
No. Lusac: 380039 Producto: MANGUERA DE FRENOS 		No. Lusac: 380040 Producto: MANGUERA DE FRENOS 		No. Lusac: 380041 Producto: MANGUERA DE FRENOS 	
DIAMETRO	19.5"	DIAMETRO	19.5"	DIAMETRO	11.75"
DODGE DAKOTA 96		DODGE DAKOTA 96		FORD GRAND MARQUIS 92-94 LINCOLN TOWN CAR 91-94	
No. Lusac: 380042 Producto: MANGUERA DE FRENOS 		No. Lusac: 380043 Producto: MANGUERA DE FRENOS 		No. Lusac: 380044 Producto: MANGUERA DE FRENOS 	
DIAMETRO	11.25"	DIAMETRO	12.25"	DIAMETRO	12"
FORD GRAND MARQUIS 92-94 LINCOLN TOWN CAR 91-94		FORD GRAND MARQUIS 92-97		FORD GRAND MARQUIS 92-97	



Fotografías de producto y especificaciones





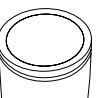

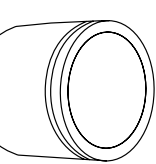



No. Lusac: 380046		No. Lusac: 380047		No. Lusac: 380048	
Producto: MANGUERA DE FRENOS		Producto: MANGUERA DE FRENOS		Producto: MANGUERA DE FRENOS	
					
DIAMETRO	21.36"	DIAMETRO	17.16"	DIAMETRO	17.16"
FORD		CHEVROLET OLDSMOBILE		CHEVROLET OLDSMOBILE	
F150 94-96		LUMINA 95-96 SILHOUETTE 92-94-95		LUMINA 95-96 SILHOUETTE 92-94-95	
No. Lusac: 380055		No. Lusac: 380056		No. Lusac: 380058	
Producto: MANGUERA DE FRENOS		Producto: MANGUERA DE FRENOS		Producto: MANGUERA DE FRENOS	
					
DIAMETRO	26.25"	DIAMETRO	26.55"	DIAMETRO	26.25"
HONDA		HONDA		HONDA	
CIVIC 92-95		CIVIC 92-95		CIVIC 92-95	
No. Lusac: 380062		No. Lusac: 380064		No. Lusac: 380070	
Producto: MANGUERA DE FRENOS		Producto: MANGUERA DE FRENOS		Producto: MANGUERA DE FRENOS	
					
DIAMETRO	18.5"	DIAMETRO	19"	DIAMETRO	17.13"
HONDA		HONDA		CHRYSLER	
CIVIC 97-02		CIVIC 97-00		GRAND VOYAGER 95 VOYAGER 97-00 TOWN & COUNTRY 93	





Fotografías de producto y especificaciones

No. Lusac: 380071 Producto: MANGUERA DE FRENOS		No. Lusac: 380072 Producto: MANGUERA DE FRENOS		No. Lusac: 380073 Producto: MANGUERA DE FRENOS	
					
DIAMETRO	23"	DIAMETRO	22.75"	DIAMETRO	22.75"
CHRYSLER DODGE GRAND VOYAGER 95 SHADOW 90-90 IMPERIAL 91 TOWN & COUNTRY 93-95 VOYAGER 95		CHRYSLER DODGE GRAND VOYAGER 95 SHADOW 90 IMPERIAL 91 TOWN & COUNTRY 93-95 VOYAGER 95		CHRYSLER DODGE LE BARON 92-95 SHADOW 91-94 NEW YORKER 90-94 SPIRIT RT 91-95 PHANTOM 90-94 VOYAGER 95	
No. Lusac: 380074 Producto: MANGUERA DE FRENOS		No. Lusac: 380075 Producto: MANGUERA DE FRENOS		No. Lusac: 380076 Producto: MANGUERA DE FRENOS	
					
DIAMETRO	22.5"	DIAMETRO	24"	DIAMETRO	22.5"
CHRYSLER DODGE LE BARON 92-95 SHADOW 91-94 NEW YORKER 90-94 SPIRIT RT 91-95 PHANTOM 90-94 VOYAGER 95-95		FORD E150 92-93		FORD E150 92-93	
No. Lusac: 380089 Producto: MANGUERA DE FRENOS		No. Lusac: 380090 Producto: MANGUERA DE FRENOS		No. Lusac: 380091 Producto: MANGUERA DE FRENOS	
					
DIAMETRO	16.5"	DIAMETRO	16.5"	DIAMETRO	19.25"
CHRYSLER DODGE CONCORDE 93-97 INTREPID 94-97 NEW YORKER 94-96		CHRYSLER DODGE CONCORDE 93-97 INTREPID 94-97 NEW YORKER 94-96		CHRYSLER DODGE CONCORDE 93-97 INTREPID 94-97	

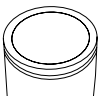

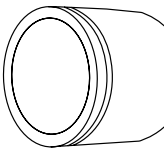



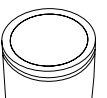

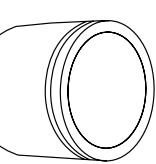



No. Lusac: 380092		No. Lusac: 380094		No. Lusac: 380103	
Producto: MANGUERA DE FRENOS		Producto: MANGUERA DE FRENOS		Producto: MANGUERA DE FRENOS	
DIAMETRO	18"	DIAMETRO	17.05"	DIAMETRO	21.25"
CHRYSLER		CHEVROLET		MERCURY	
DODGE		ISUZU		NISSAN	
CONCORDE 93-97		LUV 01-05		VILLAGER 93-02	
INTREPID 94-97		RODEO 96-97		QUEST 93-98 97-98	
No. Lusac: 380104		No. Lusac: 380108		No. Lusac: 380109	
Producto: MANGUERA DE FRENOS		Producto: MANGUERA DE FRENOS		Producto: MANGUERA DE FRENOS	
DIAMETRO	13.75"	DIAMETRO	22"	DIAMETRO	11.5"
NISSAN		INFINITI		INFINITI	
QUEST 97-98		Q45 97-02		Q45 97-01	
No. Lusac: 380110		No. Lusac: 380121		No. Lusac: 380189	
Producto: MANGUERA DE FRENOS		Producto: MANGUERA DE FRENOS		Producto: MANGUERA DE FRENOS	
DIAMETRO	22"	DIAMETRO	13.25"	DIAMETRO	21.75"
INFINITI		PORSCHE		JEEP	
Q45 97-02		911 CARRERA CARRERA 97-98		GRAND CHEROKEE 93-98	
NISSAN					
SENTRA 92					









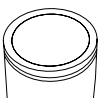

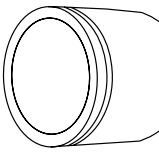



Fotografías de producto y especificaciones

No. Lusac: 380191 Producto: MANGUERA DE FRENOS 		No. Lusac: 380192 Producto: MANGUERA DE FRENOS 		No. Lusac: 380193 Producto: MANGUERA DE FRENOS 	
DIAMETRO	11.38"	DIAMETRO	12"	DIAMETRO	20"
CHEVROLET CORVETTE 93-96		CHEVROLET CORVETTE 93		FORD COUGAR 90-95 THUNDERBIRD 93-96 03-04	
LINCOLN MARK VIII 94-96				LINCOLN MARK VIII 94-96	
No. Lusac: 380194 Producto: MANGUERA DE FRENOS 		No. Lusac: 380196 Producto: MANGUERA DE FRENOS 		No. Lusac: 380206 Producto: MANGUERA DE FRENOS 	
DIAMETRO	25.25"	DIAMETRO	18"	DIAMETRO	18"
FORD COUGAR 90-95 THUNDERBIRD 93-96 03-04		LINCOLN MARK VIII 94-96		FORD F150 92-99 F250 XL 98-99 92-96 F350 98-04	
				CHRYSLER CONCORDE 93-97 01-02 NEW YORKER 94-96	
				DODGE INTREPID 94-97	
No. Lusac: 380207 Producto: MANGUERA DE FRENOS 		No. Lusac: 380214 Producto: MANGUERA DE FRENOS 		No. Lusac: 380215 Producto: MANGUERA DE FRENOS 	
DIAMETRO	21.5"	DIAMETRO	20"	DIAMETRO	17.88"
CHRYSLER CONCORDE 93-97 01-02 NEW YORKER 94-96		DODGE INTREPID 94-97		FORD COUGAR 95-95 THUNDERBIRD 93-96	
				FORD COUGAR 95-95 THUNDERBIRD 93-96	







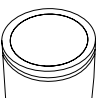

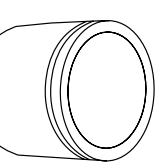



<p>No. Lusac: 380217</p> <p>Producto: MANGUERA DE FRENOS</p> 		<p>No. Lusac: 380223</p> <p>Producto: MANGUERA DE FRENOS</p> 		<p>No. Lusac: 380224</p> <p>Producto: MANGUERA DE FRENOS</p> 	
DIAMETRO	21"	DIAMETRO	13"	DIAMETRO	19.88"
<p>DODGE</p> <p>RAM 3500 MAXI WAGON 95-97 RAM WAGON 1500 95-97</p> <p>RAM VAN 1500 95-97 RAM WAGON 2500 96-97</p> <p>RAM VAN 2500 96-97</p> <p>RAM VAN 3500 95-97</p>		<p>NISSAN</p> <p>ALTIMA 96-97 00-01</p> <p>HIKARI 88-92</p>		<p>NISSAN</p> <p>ALTIMA 96-01</p> <p>HIKARI 88-92</p>	
<p>No. Lusac: 380225</p> <p>Producto: MANGUERA DE FRENOS</p> 		<p>No. Lusac: 380226</p> <p>Producto: MANGUERA DE FRENOS</p> 		<p>No. Lusac: 380227</p> <p>Producto: MANGUERA DE FRENOS</p> 	
DIAMETRO	7.75"	DIAMETRO	8.75"	DIAMETRO	14.13"
<p>JEEP</p> <p>GRAND CHEROKEE 95-98</p>		<p>JEEP</p> <p>GRAND CHEROKEE 95-98</p>		<p>VOLVO</p> <p>C70 99-01 V70 98-04</p> <p>S70 99-00</p>	
<p>No. Lusac: 380228</p> <p>Producto: MANGUERA DE FRENOS</p> 		<p>No. Lusac: 380229</p> <p>Producto: MANGUERA DE FRENOS</p> 		<p>No. Lusac: 380245</p> <p>Producto: MANGUERA DE FRENOS</p> 	
DIAMETRO	19 7/8"	DIAMETRO	21"	DIAMETRO	12.38"
<p>JEEP</p> <p>WRANGLER 93-96</p>		<p>JEEP</p> <p>WRANGLER 93-96</p>		<p>CHEVROLET</p> <p>LUMINA 93-94</p>	









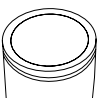

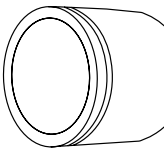



Fotografías de producto y especificaciones

No. Lusac: 380248 Producto: MANGUERA DE FRENOS 		No. Lusac: 380249 Producto: MANGUERA DE FRENOS 		No. Lusac: 380259 Producto: MANGUERA DE FRENOS 	
DIAMETRO	20.63"	DIAMETRO	20.63"	DIAMETRO	15.5"
CHEVROLET C2500 CLASSIC SILVERADO 99-00 C3500 SILVERADO CLASSIC 99		CHEVROLET C2500 CLASSIC SILVERADO 99-00 C3500 SILVERADO CLASSIC 99		CHEVROLET SIERRA 2500 99-00 CORVETTE 94-96	
No. Lusac: 380260 Producto: MANGUERA DE FRENOS 		No. Lusac: 380261 Producto: MANGUERA DE FRENOS 		No. Lusac: 380263 Producto: MANGUERA DE FRENOS 	
DIAMETRO	15.5"	DIAMETRO	18.25"	DIAMETRO	15"
CHEVROLET CORVETTE 94-96		OLDSMOBILE EIGHTY EIGHT 94-95		PONTIAC BONNEVILLE 94-99	
No. Lusac: 380264 Producto: MANGUERA DE FRENOS 		No. Lusac: 380265 Producto: MANGUERA DE FRENOS 		No. Lusac: 380268 Producto: MANGUERA DE FRENOS 	
DIAMETRO	18.5"	DIAMETRO	18.25"	DIAMETRO	12.63"
FORD WINDSTAR 95-98		FORD WINDSTAR 95-98		CADILLAC SEVILLE STS 98-98	







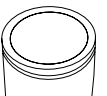

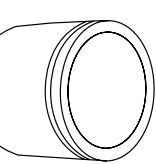



No. Lusac: 380271 Producto: MANGUERA DE FRENOS 		No. Lusac: 380272 Producto: MANGUERA DE FRENOS 		No. Lusac: 380280 Producto: MANGUERA DE FRENOS 	
DIAMETRO	12.5"	DIAMETRO	12.38"	DIAMETRO	12.13"
OLDSMOBILE EIGHTY EIGHT 94-95		PONTIAC BONNEVILLE 94-99		CADILLAC DEVILLE 94-95 ELDORADO 94-95 SEVILLE 94-95	
CHEVROLET BLAZER 95-97 S-10 5-99		ISUZU HOMBRE 98-00			
No. Lusac: 380289 Producto: MANGUERA DE FRENOS 		No. Lusac: 380294 Producto: MANGUERA DE FRENOS 		No. Lusac: 380296 Producto: MANGUERA DE FRENOS 	
DIAMETRO	11.75"	DIAMETRO	10.88"	DIAMETRO	11"
PONTIAC FIREBIRD TRANS AM 98-01		BUICK REGAL 94		FORD GRAND MARQUIS 95-97	
LINCOLN TOWN CAR 95-00					
No. Lusac: 380297 Producto: MANGUERA DE FRENOS 		No. Lusac: 380298 Producto: MANGUERA DE FRENOS 		No. Lusac: 380299 Producto: MANGUERA DE FRENOS 	
DIAMETRO	11"	DIAMETRO	19.5"	DIAMETRO	19"
FORD GRAND MARQUIS 95-97		LINCOLN TOWN CAR 95-00		FORD F150 94-95	
				FORD F150 94-95	









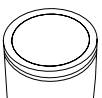

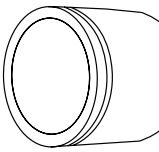



Fotografías de producto y especificaciones

No. Lusac: 380303 Producto: MANGUERA DE FRENOS		No. Lusac: 380304 Producto: MANGUERA DE FRENOS		No. Lusac: 380305 Producto: MANGUERA DE FRENOS	
					
DIAMETRO	19.5"	DIAMETRO	14.63"	DIAMETRO	17.75"
DODGE RAM 2500 98-99		CHRYSLER CIRRUS 96-97 STRATUS 95-90 SEBRING RT 97		CHRYSLER CIRRUS 96-00 STRATUS 95-02	
No. Lusac: 380306 Producto: MANGUERA DE FRENOS		No. Lusac: 380307 Producto: MANGUERA DE FRENOS		No. Lusac: 380308 Producto: MANGUERA DE FRENOS	
					
DIAMETRO	18.38"	DIAMETRO	18.38"	DIAMETRO	14.13"
CHRYSLER CIRRUS 96-00 STRATUS 95-02		CHRYSLER SEBRING 00-00 STRATUS 95-00		CHRYSLER SEBRING 96-00 STRATUS 95-00	
No. Lusac: 380309 Producto: MANGUERA DE FRENOS		No. Lusac: 380310 Producto: MANGUERA DE FRENOS		No. Lusac: 380311 Producto: MANGUERA DE FRENOS	
					
DIAMETRO	16.13"	DIAMETRO	21"	DIAMETRO	19.13"
CHRYSLER CIRRUS 96-97 STRATUS 95-00 SEBRING RT 97		FORD EXPLORER 92		FORD EXPLORER 92	





No. Lusac: 380317		No. Lusac: 380318		No. Lusac: 380319	
Producto: MANGUERA DE FRENOS		Producto: MANGUERA DE FRENOS		Producto: MANGUERA DE FRENOS	
					
DIAMETRO	21.5"	DIAMETRO	21"	DIAMETRO	22.75"
FORD EXPLORER 93-94		FORD EXPLORER 93-94		FORD BRONCO 94-96	
No. Lusac: 380320		No. Lusac: 380323		No. Lusac: 380324	
Producto: MANGUERA DE FRENOS		Producto: MANGUERA DE FRENOS		Producto: MANGUERA DE FRENOS	
					
DIAMETRO	21.5"	DIAMETRO	20.75"	DIAMETRO	22.75"
FORD BRONCO 94-96		FORD E150 CLUB WAGON 95-05		FORD E150 ECONLINE WAGON VAN 94-07 E250 ECONLINE VAN 99-00 02 04-07	
No. Lusac: 380325		No. Lusac: 380326		No. Lusac: 380329	
Producto: MANGUERA DE FRENOS		Producto: MANGUERA DE FRENOS		Producto: MANGUERA DE FRENOS	
					
DIAMETRO	24.75"	DIAMETRO	24.75"	DIAMETRO	24"
FORD WINDSTAR 95-03		FORD WINDSTAR 95-03		CHRYSLER NEON 96-99	

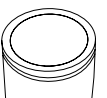

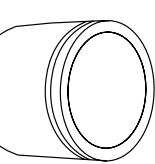





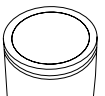

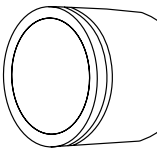

Fotografías de producto y especificaciones

No. Lusac: 380330 Producto: MANGUERA DE FRENOS		No. Lusac: 380331 Producto: MANGUERA DE FRENOS		No. Lusac: 380332 Producto: MANGUERA DE FRENOS	
DIAMETRO	24"	DIAMETRO	20.75"	DIAMETRO	20.75"
CHRYSLER NEON 95-97		CHRYSLER NEON 95-95		CHRYSLER NEON 95-95	
No. Lusac: 380333 Producto: MANGUERA DE FRENOS		No. Lusac: 380334 Producto: MANGUERA DE FRENOS		No. Lusac: 380335 Producto: MANGUERA DE FRENOS	
DIAMETRO	20.75"	DIAMETRO	20.75"	DIAMETRO	17.13"
CHRYSLER NEON 95-99		CHRYSLER NEON 95-99		CHRYSLER NEON 95-96	
No. Lusac: 380336 Producto: MANGUERA DE FRENOS		No. Lusac: 380337 Producto: MANGUERA DE FRENOS		No. Lusac: 380338 Producto: MANGUERA DE FRENOS	
DIAMETRO	17.13"	DIAMETRO	17.75"	DIAMETRO	17.13"
CHRYSLER NEON 95-96		CHRYSLER NEON 95-97		CHRYSLER NEON 95-99	



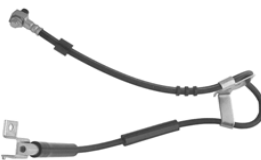



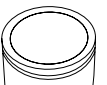

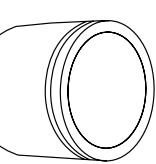



<p>No. Lusac: 380339</p> <p>Producto: MANGUERA DE FRENOS</p> 		<p>No. Lusac: 380340</p> <p>Producto: MANGUERA DE FRENOS</p> 		<p>No. Lusac: 380341</p> <p>Producto: MANGUERA DE FRENOS</p> 	
DIAMETRO	19"	DIAMETRO	18.75"	DIAMETRO	18.75"
<p>DODGE</p> <p>D250 91-92 RAM 3500 94-97</p> <p>RAM 1500 94-98</p> <p>RAM 2500 95-95</p>		<p>DODGE</p> <p>D250 91-92 RAM 3500 MAXI WAGON 97-99</p> <p>RAM 1500 94-99 RAM VAN 3500 98-99</p> <p>RAM 2500 95-97</p>		<p>DODGE</p> <p>RAM 2500 94-94</p>	
<p>No. Lusac: 380342</p> <p>Producto: MANGUERA DE FRENOS</p> 		<p>No. Lusac: 380343</p> <p>Producto: MANGUERA DE FRENOS</p> 		<p>No. Lusac: 380344</p> <p>Producto: MANGUERA DE FRENOS</p> 	
DIAMETRO	19"	DIAMETRO	39.25"	DIAMETRO	39.25"
<p>CADILLAC</p> <p>STS 05-10 RAM 2500 94</p> <p>DODGE</p> <p>RAM 1500 94-99</p>		<p>DODGE</p> <p>RAM 1500 94-98 RAM 4000 95-97</p> <p>RAM 2500 96 98-99</p> <p>RAM 3500 94-97</p>		<p>DODGE</p> <p>RAM 1500 94-99 RAM SRT-10 05-06</p> <p>RAM 2500 94 96-99 RAM VAN 3500 00-01</p> <p>RAM 3500 MAXI WAGON 94-01</p> <p>RAM 4000 95-97 99</p>	
<p>No. Lusac: 380345</p> <p>Producto: MANGUERA DE FRENOS</p> 		<p>No. Lusac: 380353</p> <p>Producto: MANGUERA DE FRENOS</p> 		<p>No. Lusac: 380354</p> <p>Producto: MANGUERA DE FRENOS</p> 	
DIAMETRO	39.25"	DIAMETRO	21"	DIAMETRO	20.25"
<p>DODGE</p> <p>RAM 1500 94-99</p> <p>RAM 2500 94</p>		<p>FORD</p> <p>F250 95-98 F350 95-97</p> <p>F300 95-97</p>		<p>FORD</p> <p>F250 95-98 F350 95-97</p> <p>F300 95-97</p>	





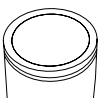

Fotografías de producto y especificaciones

No. Lusac: 380355 Producto: MANGUERA DE FRENOS 		No. Lusac: 380356 Producto: MANGUERA DE FRENOS 		No. Lusac: 380357 Producto: MANGUERA DE FRENOS 	
DIAMETRO	24"	DIAMETRO	21.5"	DIAMETRO	13.25"
FORD E150 ECONLINE WAGON VAN 97-99 E250 ECONLINE VAN 97-99 E350 ECONLINE CLUB WAGON VAN 97-98		FORD LINCOLN E150 ECONLINE WAGON VAN 97-07 EXPEDITION 00-02 NAVIGATOR 01-02		FORD EXPLORER SPORT 95-03 RANGER 98-11	
No. Lusac: 380358 Producto: MANGUERA DE FRENOS 		No. Lusac: 380360 Producto: MANGUERA DE FRENOS 		No. Lusac: 380361 Producto: MANGUERA DE FRENOS 	
DIAMETRO	13.25"	DIAMETRO	15.25"	DIAMETRO	18.5"
FORD EXPLORER SPORT 95-03 RANGER 98-11		LINCOLN CONTINENTAL 97		LINCOLN CONTINENTAL 97-99	
No. Lusac: 380362 Producto: MANGUERA DE FRENOS 		No. Lusac: 380365 Producto: MANGUERA DE FRENOS 		No. Lusac: 380366 Producto: MANGUERA DE FRENOS 	
DIAMETRO	18.5"	DIAMETRO	16.25"	DIAMETRO	16.5"
LINCOLN CONTINENTAL 97-99		FORD MUSTANG COBRA 97		FORD MUSTANG COBRA 97	

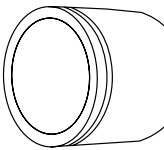





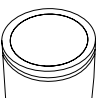

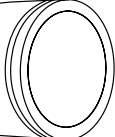



<p>No. Lusac: 380371</p> <p>Producto: MANGUERA DE FRENOS</p> 		<p>No. Lusac: 380372</p> <p>Producto: MANGUERA DE FRENOS</p> 		<p>No. Lusac: 380373</p> <p>Producto: MANGUERA DE FRENOS</p> 	
DIAMETRO	11"	DIAMETRO	10.25"	DIAMETRO	16"
<p>FORD</p> <p>MUSTANG GT 94-98</p>		<p>FORD</p> <p>MUSTANG GT 94-98</p>		<p>FORD</p> <p>COUGAR 90-95 THUNDERBIRD 93-96</p>	
<p>No. Lusac: 380374</p> <p>Producto: MANGUERA DE FRENOS</p> 		<p>No. Lusac: 380375</p> <p>Producto: MANGUERA DE FRENOS</p> 		<p>No. Lusac: 380376</p> <p>Producto: MANGUERA DE FRENOS</p> 	
DIAMETRO	16"	DIAMETRO	47.5"	DIAMETRO	27.75"
<p>FORD</p> <p>COUGAR 90-95 THUNDERBIRD 90-96</p>		<p>FORD</p> <p>F450 SUPER DUTY 97-98</p>		<p>FORD</p> <p>EXPLORER EDDIE BAUER SPORT 98-03</p>	
<p>No. Lusac: 380378</p> <p>Producto: MANGUERA DE FRENOS</p> 		<p>No. Lusac: 380379</p> <p>Producto: MANGUERA DE FRENOS</p> 		<p>No. Lusac: 380380</p> <p>Producto: MANGUERA DE FRENOS</p> 	
DIAMETRO	16"	DIAMETRO	16"	DIAMETRO	12.75"
<p>LINCOLN</p> <p>MARK VIII 94-96</p>		<p>LINCOLN</p> <p>MARK VIII 94-96</p>		<p>LINCOLN</p> <p>TOWN CAR 95-96</p>	









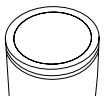

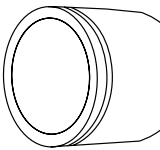



Fotografías de producto y especificaciones

No. Lusac: 380381 Producto: MANGUERA DE FRENOS		No. Lusac: 380383 Producto: MANGUERA DE FRENOS		No. Lusac: 380384 Producto: MANGUERA DE FRENOS	
					
DIAMETRO	12.75"	DIAMETRO	16.75"	DIAMETRO	20"
LINCOLN TOWN CAR 93-96		FORD F250 95-97 P350 MICROBUS 96-97 F350 98-98		FORD F250 95-97 P350 MICROBUS 96-97 F350 98-98	
No. Lusac: 380385 Producto: MANGUERA DE FRENOS		No. Lusac: 380387 Producto: MANGUERA DE FRENOS		No. Lusac: 380388 Producto: MANGUERA DE FRENOS	
					
DIAMETRO	18"	DIAMETRO	16.5"	DIAMETRO	16.75"
FORD E150 ECONLINE WAGON VAN 92-07 P350 MICROBUS 96-96 E250 ECONOLINE VAN 92-07 E350 ECONLINE CLUB WAGON VAN 92-98		FORD E150 ECONLINE WAGON VAN 95-99 E350 ECONLINE CLUB WAGON VAN 95-98 E250 ECONOLINE VAN ECONOLINE 97-03		FORD E150 ECONLINE WAGON 95-99 E350 ECONLINE CLUB WAGON VAN 95-98 E250 ECONOLINE VAN 98-99	
No. Lusac: 380389 Producto: MANGUERA DE FRENOS		No. Lusac: 380392 Producto: MANGUERA DE FRENOS		No. Lusac: 380395 Producto: MANGUERA DE FRENOS	
					
DIAMETRO	22.75"	DIAMETRO	20.25"	DIAMETRO	8"
FORD RANGER 95-97 B3000 95-97 MAZDA B4000 95-97 B2300 95-97		FORD RANGER 96-97		HONDA ACCORD 96-97	







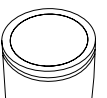

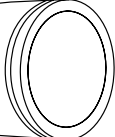



No. Lusac: 380398 Producto: MANGUERA DE FRENOS		No. Lusac: 380406 Producto: MANGUERA DE FRENOS		No. Lusac: 380411 Producto: MANGUERA DE FRENOS	
					
DIAMETRO	21.25"	DIAMETRO	12.5"	DIAMETRO	16.5"
FORD E150 ECONLINE WAGON 99		BUICK LESABRE 00-05 CADILLAC DEVILLE 00-05 SEVILLE STS 99-04		CHEVROLET CAMARO 95-97 PONTIAC FIREBIRD TRANS AM 94-97	
No. Lusac: 380414 Producto: MANGUERA DE FRENOS		No. Lusac: 380415 Producto: MANGUERA DE FRENOS		No. Lusac: 380416 Producto: MANGUERA DE FRENOS	
					
DIAMETRO	14"	DIAMETRO	15"	DIAMETRO	15.5"
CADILLAC DEVILLE 94-95 ELDORADO 94-95		LINCOLN CONTINENTAL 98-99		MERCURY SABLE 96-05	
SEVILLE 94-97				LINCOLN CONTINENTAL 98-99	
No. Lusac: 380417 Producto: MANGUERA DE FRENOS		No. Lusac: 380418 Producto: MANGUERA DE FRENOS		No. Lusac: 380419 Producto: MANGUERA DE FRENOS	
					
DIAMETRO	15.5"	DIAMETRO	15.5"	DIAMETRO	22.5"
MERCURY SABLE 05-05		MERCURY SABLE 05-05		MERCURY SABLE 96-05	









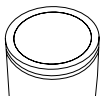



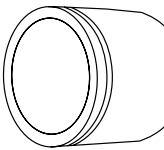

Fotografías de producto y especificaciones

No. Lusac: 380420 Producto: MANGUERA DE FRENOS 		No. Lusac: 380421 Producto: MANGUERA DE FRENOS 		No. Lusac: 380422 Producto: MANGUERA DE FRENOS 	
DIAMETRO	22.5"	DIAMETRO	15.25"	DIAMETRO	12"
MERCURY SABLE 96-04		FORD CONTOUR 96-00		MERCURY MYSTIQUE 95-00	
No. Lusac: 380423 Producto: MANGUERA DE FRENOS 		No. Lusac: 380451 Producto: MANGUERA DE FRENOS 		No. Lusac: 380452 Producto: MANGUERA DE FRENOS 	
DIAMETRO	22.25"	DIAMETRO	11.75"	DIAMETRO	8.75"
FORD CONTOUR 96-97		MERCURY MYSTIQUE 95-96		FORD ESCAPE 01-06	
No. Lusac: 380455 Producto: MANGUERA DE FRENOS 		No. Lusac: 380456 Producto: MANGUERA DE FRENOS 		No. Lusac: 380457 Producto: MANGUERA DE FRENOS 	
DIAMETRO	14.25"	DIAMETRO	14"	DIAMETRO	19"
VOLKSWAGEN EUROVAN 00-04		VOLKSWAGEN PASSAT VAGONETA 91-93		VOLKSWAGEN CABRIO A3 A4 96-01 GOLF A3 GTI VR6 95-99 JETTA 93-98	



Fotografías de producto y especificaciones





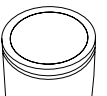

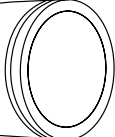



No. Lusac: 380459 Producto: MANGUERA DE FRENOS		No. Lusac: 380460 Producto: MANGUERA DE FRENOS		No. Lusac: 380461 Producto: MANGUERA DE FRENOS	
					
DIAMETRO	17.5"	DIAMETRO	20.25"	DIAMETRO	20.25"
CHRYSLER DODGE		CHRYSLER DODGE		CHRYSLER DODGE	
GRAND VOYAGER 96-02 CARAVAN 97-00 TOWN & COUNTRY 96-00 VOYAGER 96 01-02		GRAND VOYAGER 96-00 CARAVAN 96-00 TOWN & COUNTRY 96-00 GRAND CARAVAN 96-00 VOYAGER 96-00		GRAND VOYAGER 96-00 CARAVAN 96-00 TOWN & COUNTRY 96-00 GRAND CARAVAN 96-00 VOYAGER 96-00	
No. Lusac: 380463 Producto: MANGUERA DE FRENOS		No. Lusac: 380466 Producto: MANGUERA DE FRENOS		No. Lusac: 380467 Producto: MANGUERA DE FRENOS	
					
DIAMETRO	16.25"	DIAMETRO	12.5"	DIAMETRO	12.5"
FORD		CHEVROLET		CHEVROLET PONTIAC	
ESCORT GT VAGONETA 94-99		LUMINA 95-96		CAVALIER Z24 95-04 GRAND AM 99-04 MALIBU 97-05 SUNFIRE 95-05	
No. Lusac: 380468 Producto: MANGUERA DE FRENOS		No. Lusac: 380469 Producto: MANGUERA DE FRENOS		No. Lusac: 380473 Producto: MANGUERA DE FRENOS	
					
DIAMETRO	11.5"	DIAMETRO	10"	DIAMETRO	8.75"
CHEVROLET		CHEVROLET GMC		BMW	
C3500 96-99 C3500HD 96-99		BLAZER 98-05 JIMMY 98-02 C3500 96-99 SONOMA 98-03 C3500HD SILVERADO CLASSIC 96-99		323IA 98-01 328I 96-98 325I 95-97	











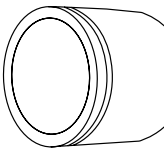



Fotografías de producto y especificaciones

No. Lusac: 380476 Producto: MANGUERA DE FRENOS 		No. Lusac: 380477 Producto: MANGUERA DE FRENOS 		No. Lusac: 380478 Producto: MANGUERA DE FRENOS 	
DIAMETRO	18.75"	DIAMETRO	9.5"	DIAMETRO	12.25"
BMW M3 95-99 Z3 98-02		BMW M3 95-99		BUICK REGAL 95-96	
No. Lusac: 380479 Producto: MANGUERA DE FRENOS 		No. Lusac: 380483 Producto: MANGUERA DE FRENOS 		No. Lusac: 380486 Producto: MANGUERA DE FRENOS 	
DIAMETRO	12.25"	DIAMETRO	7.75"	DIAMETRO	23.25"
BUICK REGAL 95-96		CHEVROLET CAMARO Z28 95-02 VENTURE APV APV 98-04		PONTIAC FIREBIRD TRANS AM 94-01 MONTANA SV6 05	
INFINITI I30 98-00		NISSAN MAXIMA 94-01		NISSAN LUCINO GSE GSR 96-00 SENTRA GSS SE 96-01	
No. Lusac: 380487 Producto: MANGUERA DE FRENOS 		No. Lusac: 380488 Producto: MANGUERA DE FRENOS 		No. Lusac: 380489 Producto: MANGUERA DE FRENOS 	
DIAMETRO	23.25"	DIAMETRO	20.25"	DIAMETRO	18.25"
INFINITI I30 98-00		NISSAN MAXIMA 94-01		NISSAN LUCINO GSE GSR 96-00 SENTRA GSS SE 96-01	
NISSAN MAXIMA 94-01		NISSAN MAXIMA 95-01		NISSAN TSURU GSR 2000 95-96	







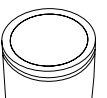

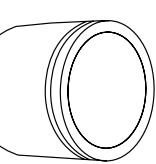



<p>No. Lusac: 380490</p> <p>Producto: MANGUERA DE FRENOS</p> 		<p>No. Lusac: 380507</p> <p>Producto: MANGUERA DE FRENOS</p> 		<p>No. Lusac: 380508</p> <p>Producto: MANGUERA DE FRENOS</p> 	
DIAMETRO	18.25"	DIAMETRO	21.5"	DIAMETRO	21.25"
<p>NISSAN</p> <p>LUCINO GSE GSR 96-00 TSURU GSR 2000 95-96</p> <p>SENTRA GSS SE 96-01</p>		<p>NISSAN</p> <p>LUCINO GSE GSR 96-00 TSURU GSR 2000 95-96</p> <p>SENTRA GSS SE 96-01</p>		<p>NISSAN</p> <p>LUCINO GSE GSR 96-00 TSURU GSR 2000 95-96</p> <p>SENTRA GSS SE 96-01</p>	
<p>No. Lusac: 380510</p> <p>Producto: MANGUERA DE FRENOS</p> 		<p>No. Lusac: 380511</p> <p>Producto: MANGUERA DE FRENOS</p> 		<p>No. Lusac: 380512</p> <p>Producto: MANGUERA DE FRENOS</p> 	
DIAMETRO	10.25"	DIAMETRO	19.06"	DIAMETRO	13.25"
<p>NISSAN</p> <p>240SX 98</p>		<p>NISSAN</p> <p>PICKUP NISSAN 96-97</p>		<p>NISSAN</p> <p>SENTRA GSS SE 96-01</p>	
<p>No. Lusac: 380515</p> <p>Producto: MANGUERA DE FRENOS</p> 		<p>No. Lusac: 380516</p> <p>Producto: MANGUERA DE FRENOS</p> 		<p>No. Lusac: 380517</p> <p>Producto: MANGUERA DE FRENOS</p> 	
DIAMETRO	15.25"	DIAMETRO	12.75"	DIAMETRO	19.75"
<p>TOYOTA</p> <p>LAND CRUISER 13-14</p> <p>LANDCRUISER 04-12</p>		<p>TOYOTA</p> <p>RAV4 04-05</p> <p>SIENNA 98-03</p>		<p>NISSAN</p> <p>ALTIMA 96-01</p> <p>HIKARI 88-92</p>	









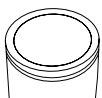



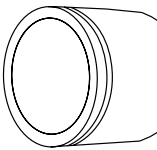

Fotografías de producto y especificaciones

No. Lusac: 380520 Producto: MANGUERA DE FRENOS		No. Lusac: 380521 Producto: MANGUERA DE FRENOS		No. Lusac: 380528 Producto: MANGUERA DE FRENOS	
					
DIAMETRO	19.25"	DIAMETRO	14.25"	DIAMETRO	11"
CHEVROLET		FORD		FORD	
BLAZER 96-01		MUSTANG COBRA GT 94-98		EXPLORER EDDIE BAUER SPORT 95-03	
No. Lusac: 380530 Producto: MANGUERA DE FRENOS		No. Lusac: 380531 Producto: MANGUERA DE FRENOS		No. Lusac: 380532 Producto: MANGUERA DE FRENOS	
					
DIAMETRO	21"	DIAMETRO	21"	DIAMETRO	18.5"
FORD		FORD		CHRYSLER	
WINDSTAR 95-03		WINDSTAR 95-03		SEBRING R/T 97	
No. Lusac: 380533 Producto: MANGUERA DE FRENOS		No. Lusac: 380534 Producto: MANGUERA DE FRENOS		No. Lusac: 380538 Producto: MANGUERA DE FRENOS	
					
DIAMETRO	25.5"	DIAMETRO	25.5"	DIAMETRO	17.75"
CHEVROLET		CHEVROLET		BMW	
C2500 CLASSIC K2500 99-00		C2500 CLASSIC K2500 99-00		325I 95-97	
SIERRA K2500 CLASSIC 99-00		SIERRA K2500 CLASSIC 99-00		Z4 03-09	
				328I 96-00	
				Z3 98-02	



Fotografías de producto y especificaciones





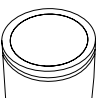

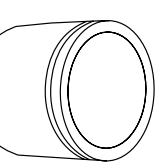



No. Lusac: 380541 Producto: MANGUERA DE FRENOS		No. Lusac: 380543 Producto: MANGUERA DE FRENOS		No. Lusac: 380545 Producto: MANGUERA DE FRENOS	
					
DIAMETRO	32"	DIAMETRO	15.5"	DIAMETRO	22.25"
DODGE RAM 2500 96-99 RAM SRT-10 05-06 RAM 3500 MAXI WAGON 98-01 RAM VAN 3500 00-01 RAM 4000 99		FORD MUSTANG COBRA 97		CHRYSLER MITSUBISHI SEBRING 95-96 98-00 ECLIPSE GT 03-05 DODGE AVENGER 95-00	
No. Lusac: 380549 Producto: MANGUERA DE FRENOS		No. Lusac: 380552 Producto: MANGUERA DE FRENOS		No. Lusac: 380553 Producto: MANGUERA DE FRENOS	
					
DIAMETRO	15"	DIAMETRO	9.25"	DIAMETRO	21"
HONDA ACCORD 96-97		SAAB 9-3 99-03		FORD EXPEDITION 97-98 LOBO 04 F150 XL 97-04 F250 XL 98-99	
No. Lusac: 380554 Producto: MANGUERA DE FRENOS		No. Lusac: 380555 Producto: MANGUERA DE FRENOS		No. Lusac: 380556 Producto: MANGUERA DE FRENOS	
					
DIAMETRO	21"	DIAMETRO	17.75"	DIAMETRO	43.25"
FORD LINCOLN EXPEDITION 97-02 NAVIGATOR 98-02 F150 XL 97-04 F250 XL 98-99 LOBO 04		FORD LINCOLN EXPEDITION 97-98 NAVIGATOR 98-00 LOBO 01-04		FORD LINCOLN EXPEDITION 97-99 NAVIGATOR 98-00 LOBO 01-04	









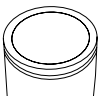

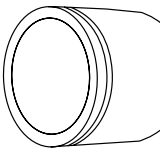



Fotografías de producto y especificaciones

No. Lusac: 380557 Producto: MANGUERA DE FRENOS 		No. Lusac: 380565 Producto: MANGUERA DE FRENOS 		No. Lusac: 380578 Producto: MANGUERA DE FRENOS 	
DIAMETRO	12.5"	DIAMETRO	26.25"	DIAMETRO	12.5"
CADILLAC DEVILLE 96-99 ELDORADO 96-02		BMW 740I 97-01 740iLA 98-01		CADILLAC DEVILLE 96-99 ELDORADO 96-02	
No. Lusac: 380579 Producto: MANGUERA DE FRENOS 		No. Lusac: 380580 Producto: MANGUERA DE FRENOS 		No. Lusac: 380581 Producto: MANGUERA DE FRENOS 	
DIAMETRO	16"	DIAMETRO	10.75"	DIAMETRO	15.5"
CHRYSLER SEBRING R/T 97		PONTIAC GRAND AM SE 99-04 GRAND PRIX 97-98		BUICK OLDSMOBILE LACROSSE CX CXL 05-08 SILHOUETTE 97-04 REGAL BASE 99-04 PONTIAC CHEVROLET GRAND PRIX 97-01 IMPALA 00-04 MONTANA SV6 05 VENTURE APV APV 97-05	
No. Lusac: 380587 Producto: MANGUERA DE FRENOS 		No. Lusac: 380588 Producto: MANGUERA DE FRENOS 		No. Lusac: 380716 Producto: MANGUERA DE FRENOS 	
DIAMETRO	21.33"	DIAMETRO	21.33"	DIAMETRO	16.25"
CHEVROLET GMC EXPRESS 2500 EXT 96 SAVANA 2500 EXT 96-02 EXPRESS 3500 CARGO VAN EXT 96-03		CHEVROLET GMC EXPRESS 2500 EXT 96-96 SAVANA 2500 EXT 96-02 EXPRESS 3500 CARGO VAN EXT 96-03		NISSAN PATHFINDER 96-04	







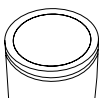

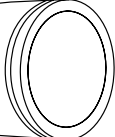



No. Lusac: 380747 Producto: MANGUERA DE FRENOS 		No. Lusac: 380749 Producto: MANGUERA DE FRENOS 		No. Lusac: 380752 Producto: MANGUERA DE FRENOS 	
DIAMETRO	19.5"	DIAMETRO	21.5"	DIAMETRO	22.75"
DODGE RAM 1500 95-99 RAM VAN 3500 98-99 RAM 2500 96-96 RAM 3500 MAXI WAGON 98-99		FORD F150 96		CHEVROLET GMC EXPRESS 1500 96 98-02 SAVANA 1500 96-02 EXPRESS 2500 EXT 96 98-99 SAVANA 2500 EXT 96-02	
No. Lusac: 380753 Producto: MANGUERA DE FRENOS 		No. Lusac: 380754 Producto: MANGUERA DE FRENOS 		No. Lusac: 380756 Producto: MANGUERA DE FRENOS 	
DIAMETRO	22.75"	DIAMETRO	16"	DIAMETRO	16.25"
CHEVROLET GMC EXPRESS 1500 98-02 96-96 SAVANA 1500 96-02 EXPRESS 2500 EXT 96 98-99 SAVANA 2500 EXT 96-02		HONDA CIVIC CX, DX, HX 96		HONDA CIVIC CX, EX 96-01	
No. Lusac: 380758 Producto: MANGUERA DE FRENOS 		No. Lusac: 380761 Producto: MANGUERA DE FRENOS 		No. Lusac: 380773 Producto: MANGUERA DE FRENOS 	
DIAMETRO	16.25"	DIAMETRO	22.25"	DIAMETRO	23.25"
HONDA CIVIC CX, EX 96-01		NISSAN PATHFINDER 96-04 PICKUP NISSAN 97		DODGE DAKOTA 97-04 DURANGO 98-99	









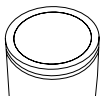

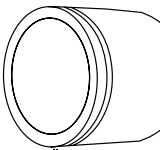



Fotografías de producto y especificaciones

No. Lusac: 380785 Producto: MANGUERA DE FRENOS 		No. Lusac: 380889 Producto: MANGUERA DE FRENOS 		No. Lusac: 380896 Producto: MANGUERA DE FRENOS 	
DIAMETRO	17.25"	DIAMETRO	17.85"	DIAMETRO	10.6"
HONDA CIVIC CX, DX, HX 96		JEEP WRANGLER 97-06		CHEVROLET LUMINA 97-99	
No. Lusac: 380897 Producto: MANGUERA DE FRENOS 		No. Lusac: 380901 Producto: MANGUERA DE FRENOS 		No. Lusac: 380902 Producto: MANGUERA DE FRENOS 	
DIAMETRO	10.6"	DIAMETRO	17.98"	DIAMETRO	17.98"
CHEVROLET LUMINA 97-99		TOYOTA RAV4 04-05		TOYOTA RAV4 04-05	
No. Lusac: 380907 Producto: MANGUERA DE FRENOS 		No. Lusac: 380908 Producto: MANGUERA DE FRENOS 		No. Lusac: 380912 Producto: MANGUERA DE FRENOS 	
DIAMETRO	17 13/16"	DIAMETRO	17 13/16"	DIAMETRO	7.4"
CADILLAC DEVILLE 94-99 SEVILLE STS 98-01 94-95 ELDORADO 94-97		CADILLAC DEVILLE 94-99 SEVILLE STS 98-01 94-95 ELDORADO 94-97		CHEVROLET OLDSMOBILE VENTURE 05 SILHOUETTE 97-04	







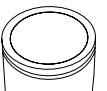

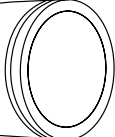



No. Lusac: 380913		No. Lusac: 380920		No. Lusac: 380931	
Producto: MANGUERA DE FRENOS		Producto: MANGUERA DE FRENOS		Producto: MANGUERA DE FRENOS	
					
DIAMETRO	15.33"	DIAMETRO	10.9"	DIAMETRO	9.82"
CHEVROLET		FORD		FORD	
VENTURE APV 97-05		F450 SUPER DUTY 97-98		RANGER 98-05	
OLDSMOBILE					
SILHOUETTE 97-04					
No. Lusac: 380932		No. Lusac: 380935		No. Lusac: 380936	
Producto: MANGUERA DE FRENOS		Producto: MANGUERA DE FRENOS		Producto: MANGUERA DE FRENOS	
					
DIAMETRO	18.75"	DIAMETRO	21.78"	DIAMETRO	24.28"
FORD		FORD LINCOLN		FORD	
RANGER 01 03		F150 XL 97-04 LOBO 04-04 RANGER 07-07		EXPEDITION 97-99 LOBO 01-04	
No. Lusac: 380937		No. Lusac: 380938		No. Lusac: 380939	
Producto: MANGUERA DE FRENOS		Producto: MANGUERA DE FRENOS		Producto: MANGUERA DE FRENOS	
					
DIAMETRO	19"	DIAMETRO	14.62"	DIAMETRO	20.98"
FORD		FORD		FORD	
EXPEDITION 97-02		RANGER 97		EXPEDITION 00-02	
LINCOLN		MAZDA		LINCOLN	
NAVIGATOR 98-02		B2300 97		NAVIGATOR 98-02	



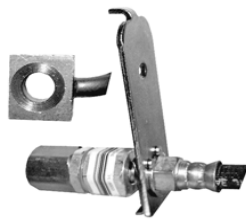





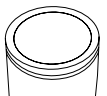



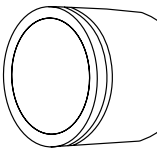

Fotografías de producto y especificaciones

No. Lusac: 380953 Producto: MANGUERA DE FRENOS 		No. Lusac: 380967 Producto: MANGUERA DE FRENOS 		No. Lusac: 380975 Producto: MANGUERA DE FRENOS 	
DIAMETRO	16.13"	DIAMETRO	10.55"	DIAMETRO	17"
FORD RANGER 98-00 05		NISSAN TIIDA 07-12		CHRYSLER STRATUS 95-00	
No. Lusac: 380976 Producto: MANGUERA DE FRENOS 		No. Lusac: 380977 Producto: MANGUERA DE FRENOS 		No. Lusac: 380978 Producto: MANGUERA DE FRENOS 	
DIAMETRO	17.75"	DIAMETRO	22.75"	DIAMETRO	22.75"
CHRYSLER STRATUS 95-00		CHRYSLER CIRRUS 98-00		CHRYSLER CIRRUS 98-00 STRATUS 98-02	
No. Lusac: 380979 Producto: MANGUERA DE FRENOS 		No. Lusac: 380980 Producto: MANGUERA DE FRENOS 		No. Lusac: 380992 Producto: MANGUERA DE FRENOS 	
DIAMETRO	17.5"	DIAMETRO	17.5"	DIAMETRO	12.28"
DODGE DURANGO 98-99		DODGE DURANGO 98-99		FORD MERCURY CONTOUR 98-00 MYSTIQUE 97-00	



Fotografías de producto y especificaciones





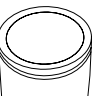

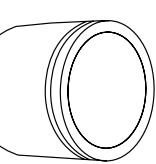



No. Lusac: 380993		No. Lusac: 381008		No. Lusac: 381019	
Producto: MANGUERA DE FRENOS		Producto: MANGUERA DE FRENOS		Producto: MANGUERA DE FRENOS	
					
DIAMETRO	22.68"	DIAMETRO	8.13"	DIAMETRO	19.33"
FORD CONTOUR 98-00		HONDA ACCORD 97		VOLKSWAGEN GOLF A3 GTI VR6 96-98 JETTA A3 VR6 96-98	
MERCURY MYSTIQUE 97-00					
No. Lusac: 381025		No. Lusac: 381026		No. Lusac: 381032	
Producto: MANGUERA DE FRENOS		Producto: MANGUERA DE FRENOS		Producto: MANGUERA DE FRENOS	
					
DIAMETRO	17.28"	DIAMETRO	17.28"	DIAMETRO	19.12"
ACURA 3.2TL 99-03		ACURA 3.2TL 99-03		CHEVROLET BLAZER 98-99 S-10 98-99	
HONDA ACCORD 98-02		HONDA ACCORD 98-02		ISUZU HOMBRE 98-00	
				GMC JIMMY 00	
No. Lusac: 381033		No. Lusac: 381046		No. Lusac: 381052	
Producto: MANGUERA DE FRENOS		Producto: MANGUERA DE FRENOS		Producto: MANGUERA DE FRENOS	
					
DIAMETRO	19.12"	DIAMETRO	12.5"	DIAMETRO	13.6"
CHEVROLET BLAZER 98-99 S-10 98-99		HONDA ACCORD 98-02		CHRYSLER 300M 99-04	
GMC JIMMY 00				DODGE INTREPID 98-01	













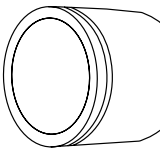

Fotografías de producto y especificaciones

No. Lusac: 381053		No. Lusac: 381054		No. Lusac: 381055	
Producto: MANGUERA DE FRENOS		Producto: MANGUERA DE FRENOS		Producto: MANGUERA DE FRENOS	
					
DIAMETRO	13.6"	DIAMETRO	14.38"	DIAMETRO	14.38"
CHRYSLER 300M 99-04		CHRYSLER 300M 99-04 CONCORDE 98-00 03-04		CHRYSLER 300M 99-04 CONCORDE 98-00 03-04	
DODGE INTREPID 98-01		DODGE INTREPID 98-01		DODGE INTREPID 98-01	
No. Lusac: 381056		No. Lusac: 381057		No. Lusac: 381058	
Producto: MANGUERA DE FRENOS		Producto: MANGUERA DE FRENOS		Producto: MANGUERA DE FRENOS	
					
DIAMETRO	24"	DIAMETRO	24"	DIAMETRO	34"
DODGE DAKOTA 97-02 DURANGO 99-04		DODGE DURANGO 99-04		DODGE DURANGO 98-99	
No. Lusac: 381060		No. Lusac: 381062		No. Lusac: 381064	
Producto: MANGUERA DE FRENOS		Producto: MANGUERA DE FRENOS		Producto: MANGUERA DE FRENOS	
					
DIAMETRO	20.32"	DIAMETRO	10.47"	DIAMETRO	12.73"
NISSAN 240SX 98		FORD F250 97-99		CHEVROLET BLAZER 98-99 02-05	
				GMC JIMMY 98-05	



Fotografías de producto y especificaciones





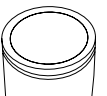

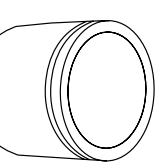



No. Lusac: 381065 Producto: MANGUERA DE FRENOS 		No. Lusac: 381070 Producto: MANGUERA DE FRENOS 		No. Lusac: 381071 Producto: MANGUERA DE FRENOS 	
DIAMETRO	11.93"	DIAMETRO	16.5"	DIAMETRO	18"
CHEVROLET BLAZER 02-05		ISUZU HOMBRE 98-00		LINCOLN CONTINENTAL 97	
GMC JIMMY 98-05 SONOMA 00-03		OLDSMOBILE BRAVADA 97-01		FORD GRAND MARQUIS 98-02	
				LINCOLN TOWN CAR 97-07	
No. Lusac: 381072 Producto: MANGUERA DE FRENOS 		No. Lusac: 381073 Producto: MANGUERA DE FRENOS 		No. Lusac: 381099 Producto: MANGUERA DE FRENOS 	
DIAMETRO	18"	DIAMETRO	20.5"	DIAMETRO	17.94"
FORD GRAND MARQUIS 98-99		LINCOLN TOWN CAR 01-06		FORD GRAND MARQUIS 98-99	
				LINCOLN TOWN CAR 97-00	
				HONDA ACCORD 98-02	
No. Lusac: 381100 Producto: MANGUERA DE FRENOS 		No. Lusac: 381102 Producto: MANGUERA DE FRENOS 		No. Lusac: 381103 Producto: MANGUERA DE FRENOS 	
DIAMETRO	17.94"	DIAMETRO	12.19"	DIAMETRO	6.58"
HONDA ACCORD 98-02		CHEVROLET BLAZER 98-99		GMC JIMMY 00	
				AUDI TT 00-06	
				VOLKSWAGEN BEETLE GLS GLX 00-10 CABRIO A3 A4 96-99 00-01	
				DERBY 95-09 GOLF A3 GTI A3 A4 GTI 93-00 07 JETTA A3 VR6 93-99	









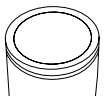

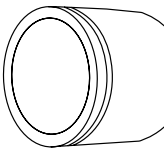



Fotografías de producto y especificaciones

No. Lusac: 381105 Producto: MANGUERA DE FRENOS 		No. Lusac: 381108 Producto: MANGUERA DE FRENOS 		No. Lusac: 381109 Producto: MANGUERA DE FRENOS 	
DIAMETRO	12.37"	DIAMETRO	21.13"	DIAMETRO	20.25"
MERCEDEZ BENZ E420 94-95 SL500 95-96 S420 94-95 98-99 SL600 95-02 95-02 S420L 96-97 SL320 95-97		NISSAN FRONTIER 98-01		NISSAN FRONTIER 02-04	
No. Lusac: 381110 Producto: MANGUERA DE FRENOS 		No. Lusac: 381115 Producto: MANGUERA DE FRENOS 		No. Lusac: 381116 Producto: MANGUERA DE FRENOS 	
DIAMETRO	20.37"	DIAMETRO	12.5"	DIAMETRO	12.75"
NISSAN 240SX 98-98		CHEVROLET PONTIAC MALIBU 97-04 GRAND AM 99-05		AUDI VOLKSWAGEN A4 AVANT 97-01 PASSAT 96-05 A6 98-06 S4 02 00-02	
No. Lusac: 381119 Producto: MANGUERA DE FRENOS 		No. Lusac: 381120 Producto: MANGUERA DE FRENOS 		No. Lusac: 381121 Producto: MANGUERA DE FRENOS 	
DIAMETRO	10.47"	DIAMETRO	15.48"	DIAMETRO	15.48"
FORD EXPEDITION 97-99		NISSAN FRONTIER 01-04 XTERRA 00-04		NISSAN FRONTIER 01-01 XTERRA 00-02	







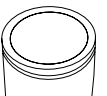

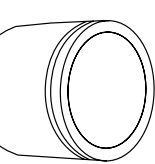



No. Lusac: 381125 Producto: MANGUERA DE FRENOS 		No. Lusac: 381126 Producto: MANGUERA DE FRENOS 		No. Lusac: 381133 Producto: MANGUERA DE FRENOS 	
DIAMETRO	N/D	DIAMETRO	11.80"	DIAMETRO	11.15"
CHEVROLET CORVETTE 97-04		CHEVROLET CAMARO Z28 98-02		FORD GRAND MARQUIS 98-02	
No. Lusac: 381134 Producto: MANGUERA DE FRENOS 		No. Lusac: 381135 Producto: MANGUERA DE FRENOS 		No. Lusac: 381136 Producto: MANGUERA DE FRENOS 	
DIAMETRO	16.35"	DIAMETRO	16.35"	DIAMETRO	10.88"
FORD RANGER 98-02 09-11 03-08 MAZDA B2300 01-10 B2500 00-01 B3000 00-08		FORD RANGER 98-02 09-11 03-08		SAAB 9-3 99-03	
No. Lusac: 381141 Producto: MANGUERA DE FRENOS 		No. Lusac: 381142 Producto: MANGUERA DE FRENOS 		No. Lusac: 381143 Producto: MANGUERA DE FRENOS 	
DIAMETRO	11.15"	DIAMETRO	8.1"	DIAMETRO	8.1"
FORD GRAND MARQUIS 98-02		LINCOLN TOWN CAR 01-04 06-07		JEEP GRAND CHEROKEE 99-05	
		JEEP GRAND CHEROKEE 99-05			









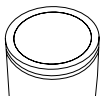



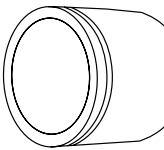

Fotografías de producto y especificaciones

No. Lusac: 381144 Producto: MANGUERA DE FRENOS 		No. Lusac: 381157 Producto: MANGUERA DE FRENOS 		No. Lusac: 381158 Producto: MANGUERA DE FRENOS 	
DIAMETRO	11.16"	DIAMETRO	11"	DIAMETRO	11"
FORD GRAND MARQUIS 01-02		FORD EXPLORER EDDIE BAUER 98-02 MAZDA B2300 06-10		FORD EXPLORER EDDIE BAUER 98-02 MAZDA B3000 00-02	
No. Lusac: 381160 Producto: MANGUERA DE FRENOS 		No. Lusac: 381161 Producto: MANGUERA DE FRENOS 		No. Lusac: 381163 Producto: MANGUERA DE FRENOS 	
DIAMETRO	18.75"	DIAMETRO	18.75"	DIAMETRO	16.89"
DODGE RAM 3500 MAXI WAGON 02 RAM WAGON 1500 98-03 98-02 RAM VAN 1500 98-03 RAM WAGON 2500 98-02 RAM VAN 2500 98-02 RAM VAN 3500 02-02		DODGE RAM 3500 MAXI WAGON 02 RAM WAGON 1500 98-03 RAM VAN 1500 98-03 RAM WAGON 2500 98-02 RAM VAN 2500 98-02 98-02 RAM VAN 3500 02		FORD EXCURSION 00-05 F250 XL 97-99	
No. Lusac: 381164 Producto: MANGUERA DE FRENOS 		No. Lusac: 381165 Producto: MANGUERA DE FRENOS 		No. Lusac: 381166 Producto: MANGUERA DE FRENOS 	
DIAMETRO	20.83"	DIAMETRO	16"	DIAMETRO	17.37"
FORD EXCURSION 01-05		FORD F350 99-04		FORD F550 SUPER DUTY 01-04	



Fotografías de producto y especificaciones





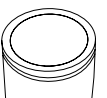

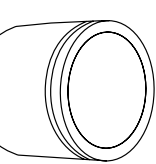



No. Lusac: 381167 Producto: MANGUERA DE FRENOS		No. Lusac: 381168 Producto: MANGUERA DE FRENOS		No. Lusac: 381169 Producto: MANGUERA DE FRENOS	
					
DIAMETRO	18.35"	DIAMETRO	17.37"	DIAMETRO	20.81"
FORD F250 XL XL 99 F350 99-04		FORD F450 SUPER DUTY 99-06 F550 SUPER DUTY 01-06		FORD EXCURSION 00-05 F350 99-04 F250 XL 97-99	
No. Lusac: 381170 Producto: MANGUERA DE FRENOS		No. Lusac: 381184 Producto: MANGUERA DE FRENOS		No. Lusac: 381185 Producto: MANGUERA DE FRENOS	
					
DIAMETRO	20.81"	DIAMETRO	17.98"	DIAMETRO	25"
FORD EXCURSION 00-05 F350 99-04 F250 XL XL 97-99		FORD F350 99-04		FORD F250 XL 99-99	
No. Lusac: 381186 Producto: MANGUERA DE FRENOS		No. Lusac: 381187 Producto: MANGUERA DE FRENOS		No. Lusac: 381188 Producto: MANGUERA DE FRENOS	
					
DIAMETRO	17.98"	DIAMETRO	19.98"	DIAMETRO	19.98"
FORD F350 99-04		FORD EXCURSION 00-05 F350 99-04 F250 XL 99-99		FORD EXCURSION 00-05 F350 99-04 F250 XL 99-99	













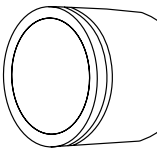

Fotografías de producto y especificaciones

No. Lusac: 381189 Producto: MANGUERA DE FRENOS 		No. Lusac: 381248 Producto: MANGUERA DE FRENOS 		No. Lusac: 381261 Producto: MANGUERA DE FRENOS 	
DIAMETRO	19.98"	DIAMETRO	10.89"	DIAMETRO	17.75"
FORD F250 99-04 F350 SUPER DUTY 99-04		HONDA ODYSSEY 99-04		ACURA MDX 01-02 HONDA ODYSSEY 99-04 PILOT 03-08	
No. Lusac: 381262 Producto: MANGUERA DE FRENOS 		No. Lusac: 381263 Producto: MANGUERA DE FRENOS 		No. Lusac: 381264 Producto: MANGUERA DE FRENOS 	
DIAMETRO	26"	DIAMETRO	26"	DIAMETRO	9.68"
FORD F450 99-04 F550 01-04		FORD F450 99-04 F550 01-04		BMW Z3 96-97 96-97	
No. Lusac: 381265 Producto: MANGUERA DE FRENOS 		No. Lusac: 381268 Producto: MANGUERA DE FRENOS 		No. Lusac: 381269 Producto: MANGUERA DE FRENOS 	
DIAMETRO	12.75"	DIAMETRO	9.65"	DIAMETRO	17.55"
PORSCHE BOXSTER S 97-12 CAYMAN 07-12		PORSCHE 911 CARRERA 97-98		BMW 528IA 96-00 540I 97-03 M5 02-03	



Fotografías de producto y especificaciones





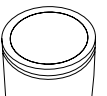

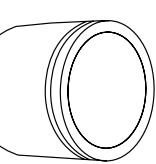



No. Lusac: 381270 Producto: MANGUERA DE FRENOS		No. Lusac: 381271 Producto: MANGUERA DE FRENOS		No. Lusac: 381272 Producto: MANGUERA DE FRENOS	
					
DIAMETRO	15.4"	DIAMETRO	10.88"	DIAMETRO	22.5"
BMW 740I 97-01 740iLA 98-01		MINI COUNTRYMAN 11-13 PACEMAN 13		BUICK LACROSSE Super 08-09 REGAL BASE 99-04 CHEVROLET IMPALA 00-04	
		PONTIAC GRAND PRIX 99-01		CHEVROLET C1500 99 SILVERADO 1500 00-06 SILVERADO 1500HD 02 SILVERADO 2500 CHEYENNE 02 SILVERADO 2500HD 02 SILVERADO 3500 01-04	
				GMC SIERRA 03 SIERRA 1500HD CLASSIC 01-03 07 SIERRA 2500 99-02 04 SIERRA 2500HD CLASSIC 01-07	
No. Lusac: 381273 Producto: MANGUERA DE FRENOS		No. Lusac: 381274 Producto: MANGUERA DE FRENOS		No. Lusac: 381276 Producto: MANGUERA DE FRENOS	
					
DIAMETRO	14.25"	DIAMETRO	14.25"	DIAMETRO	16"
CHEVROLET C1500 99 SILVERADO 1500 00-01 03-06		CHEVROLET SILVERADO 1500 00-01 03-06		CHEVROLET AVALANCHE 02-06 SILVERADO 2500 CHEYENNE CHEYENNE 07	
No. Lusac: 381280 Producto: MANGUERA DE FRENOS		No. Lusac: 381281 Producto: MANGUERA DE FRENOS		No. Lusac: 381282 Producto: MANGUERA DE FRENOS	
					
DIAMETRO	10.63"	DIAMETRO	12.25"	DIAMETRO	19.72"
FORD F250 03-04 F350 HEAVY DUTY 99-04		FORD WINDSTAR 99-03		DODGE RAM 2500 98-99	









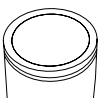



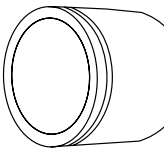

Fotografías de producto y especificaciones

No. Lusac: 381283 Producto: MANGUERA DE FRENOS 		No. Lusac: 381284 Producto: MANGUERA DE FRENOS 		No. Lusac: 381285 Producto: MANGUERA DE FRENOS 	
DIAMETRO	13.5"	DIAMETRO	13.5"	DIAMETRO	24.9"
FORD MUSTANG GT 99-04		FORD MUSTANG GT 99-04		FORD GRAND MARQUIS 00-04	
No. Lusac: 381286 Producto: MANGUERA DE FRENOS 		No. Lusac: 381287 Producto: MANGUERA DE FRENOS 		No. Lusac: 381291 Producto: MANGUERA DE FRENOS 	
DIAMETRO	24.9"	DIAMETRO	24.37"	DIAMETRO	9.95"
FORD MUSTANG GT 99-04		FORD MUSTANG GT 99-04		TOYOTA LANDCRUISER 04-07 98-03	
No. Lusac: 381292 Producto: MANGUERA DE FRENOS 		No. Lusac: 381295 Producto: MANGUERA DE FRENOS 		No. Lusac: 381296 Producto: MANGUERA DE FRENOS 	
DIAMETRO	9.95"	DIAMETRO	15.85"	DIAMETRO	15.85"
TOYOTA LANDCRUISER 98-07		TOYOTA LANDCRUISER 98-07		TOYOTA LANDCRUISER 98-07	



Fotografías de producto y especificaciones





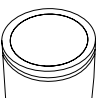

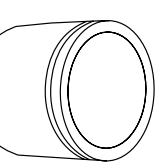



No. Lusac: 381298 Producto: MANGUERA DE FRENOS		No. Lusac: 381299 Producto: MANGUERA DE FRENOS		No. Lusac: 381302 Producto: MANGUERA DE FRENOS	
					
DIAMETRO	28.15"	DIAMETRO	28.15"	DIAMETRO	10.31"
CHEVROLET C1500 99 SILVERADO 3500 01-06 K2500 96-99 SILVERADO 1500 00-05		CHEVROLET C1500 99 SILVERADO 3500 01-06 SILVERADO 1500 00-05		FORD WINDSTAR 99-03	
No. Lusac: 381303 Producto: MANGUERA DE FRENOS		No. Lusac: 381304 Producto: MANGUERA DE FRENOS		No. Lusac: 381305 Producto: MANGUERA DE FRENOS	
					
DIAMETRO	14.13"	DIAMETRO	14.13"	DIAMETRO	18"
LINCOLN LS 00-06		LINCOLN LS 00-06		JAGUAR LINCOLN S TYPE 00-02 LS 00-06	
No. Lusac: 381306 Producto: MANGUERA DE FRENOS		No. Lusac: 381307 Producto: MANGUERA DE FRENOS		No. Lusac: 381308 Producto: MANGUERA DE FRENOS	
					
DIAMETRO	18"	DIAMETRO	17.13"	DIAMETRO	21.42"
LINCOLN LS 00-06		FORD E150 07 E350 CLUB WAGON ECONOLINE 99-14		FORD MUSTANG GT 99-04	









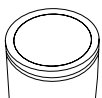

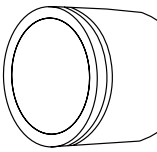



Fotografías de producto y especificaciones

No. Lusac: 381309 Producto: MANGUERA DE FRENOS 		No. Lusac: 381310 Producto: MANGUERA DE FRENOS 		No. Lusac: 381311 Producto: MANGUERA DE FRENOS 	
DIAMETRO	12.24"	DIAMETRO	13.07"	DIAMETRO	13.07"
FORD MUSTANG GT 99-04		LINCOLN TOWN CAR 98-05		LINCOLN TOWN CAR 98-05	
No. Lusac: 381312 Producto: MANGUERA DE FRENOS 		No. Lusac: 381332 Producto: MANGUERA DE FRENOS 		No. Lusac: 381338 Producto: MANGUERA DE FRENOS 	
DIAMETRO	16.73"	DIAMETRO	25.75"	DIAMETRO	19.5"
FORD RANGER 98-00		FORD RANGER 98-00		FORD LINCOLN EXPEDITION 00-02 BLACKWOOD 03 F250 XL 99 NAVIGATOR 98-02 LOBO 01-04	
No. Lusac: 381339 Producto: MANGUERA DE FRENOS 		No. Lusac: 381340 Producto: MANGUERA DE FRENOS 		No. Lusac: 381342 Producto: MANGUERA DE FRENOS 	
DIAMETRO	20.46"	DIAMETRO	18.12"	DIAMETRO	12.45"
DODGE RAM 1500 00-01 RAM 4000 00-01 RAM 2500 00-01 RAM 3500 00-02		DODGE RAM 1500 00-01 RAM 4000 00-01 RAM 2500 00-01 RAM 3500 00-02		CHEVROLET GMC BLAZER 00-05 JIMMY 00-02	







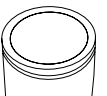

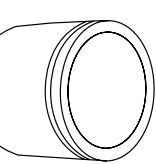



No. Lusac: 381343 Producto: MANGUERA DE FRENOS		No. Lusac: 381344 Producto: MANGUERA DE FRENOS		No. Lusac: 381345 Producto: MANGUERA DE FRENOS	
					
DIAMETRO	19.45"	DIAMETRO	19.12"	DIAMETRO	12.37"
CHEVROLET BLAZER 00-01		CHEVROLET BLAZER 00-01		CHEVROLET GMC S-10 00-04 00-04 SONOMA 00-03	
No. Lusac: 381349 Producto: MANGUERA DE FRENOS		No. Lusac: 381350 Producto: MANGUERA DE FRENOS		No. Lusac: 381351 Producto: MANGUERA DE FRENOS	
					
DIAMETRO	10.85"	DIAMETRO	21.35"	DIAMETRO	19.75"
SUBARU LEGACY 2.5 GT 99-01 05		SUBARU FORESTER 03-08 OUTBACK 00-10		SUBARU LEGACY 2.5 GT 05-10	
No. Lusac: 381352 Producto: MANGUERA DE FRENOS		No. Lusac: 381353 Producto: MANGUERA DE FRENOS		No. Lusac: 381354 Producto: MANGUERA DE FRENOS	
					
DIAMETRO	21.35"	DIAMETRO	19.75"	DIAMETRO	22.06"
SUBARU OUTBACK 00-10		SUBARU LEGACY 2.5 GT 05-10		DODGE RAM 1500 00-01 RAM 2500 01-02	









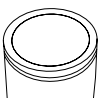

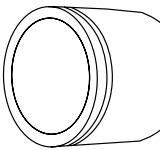

Fotografías de producto y especificaciones

No. Lusac: 381355		No. Lusac: 381360		No. Lusac: 381361	
Producto: MANGUERA DE FRENOS		Producto: MANGUERA DE FRENOS		Producto: MANGUERA DE FRENOS	
					
DIAMETRO	21"	DIAMETRO	21.42"	DIAMETRO	10.5"
DODGE RAM 1500 00-01 RAM 2500 01-02		DODGE DURANGO 99-04		CHRYSLER CONCORDE 00-02	
No. Lusac: 381362		No. Lusac: 381363		No. Lusac: 381364	
Producto: MANGUERA DE FRENOS		Producto: MANGUERA DE FRENOS		Producto: MANGUERA DE FRENOS	
					
DIAMETRO	17"	DIAMETRO	7.25" & 9.75"	DIAMETRO	7.25" & 10"
CHRYSLER CONCORDE 00-02		DODGE DAKOTA 00-00 DURANGO 00-02		DODGE DAKOTA 00-00 DURANGO 00-02	
No. Lusac: 381365		No. Lusac: 381367		No. Lusac: 381369	
Producto: MANGUERA DE FRENOS		Producto: MANGUERA DE FRENOS		Producto: MANGUERA DE FRENOS	
					
DIAMETRO	18.85"	DIAMETRO	22.13"	DIAMETRO	8.95"
FORD EXPEDITION 00-01		LINCOLN NAVIGATOR 01-02		DODGE RAM 1500 00-01 RAM 2500 00 RAM 3500 00-02	
				FORD FOCUS LX SVT ZX3 00-04 07	







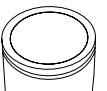

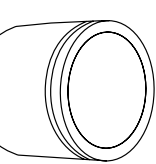



<p>No. Lusac: 381376</p> <p>Producto: MANGUERA DE FRENOS</p> 		<p>No. Lusac: 381377</p> <p>Producto: MANGUERA DE FRENOS</p> 		<p>No. Lusac: 381378</p> <p>Producto: MANGUERA DE FRENOS</p> 	
DIAMETRO	14.1"	DIAMETRO	14.05"	DIAMETRO	18.23"
<p>FORD</p> <p>FOCUS EUROPA LX SVT ZX3 00-07</p>		<p>MERCURY</p> <p>VILLAGER 00-02</p>		<p>NISSAN</p> <p>QUEST 99-02 99-02</p>	
<p>CHRYSLER</p> <p>NEON SRT4 00-05</p>		<p>No. Lusac: 381379</p> <p>Producto: MANGUERA DE FRENOS</p> 		<p>No. Lusac: 381380</p> <p>Producto: MANGUERA DE FRENOS</p> 	
DIAMETRO	18.23"	DIAMETRO	16.05"	DIAMETRO	16.2"
<p>CHRYSLER</p> <p>NEON SRT4 00-05</p>		<p>CHEVROLET</p> <p>SONORA 00-02 TAHOE 00-01 SUBURBAN 1500 01-03</p>		<p>CHEVROLET</p> <p>AVALANCHE 02</p>	
<p>No. Lusac: 381382</p> <p>Producto: MANGUERA DE FRENOS</p> 		<p>No. Lusac: 381383</p> <p>Producto: MANGUERA DE FRENOS</p> 		<p>No. Lusac: 381388</p> <p>Producto: MANGUERA DE FRENOS</p> 	
DIAMETRO	18.75"	DIAMETRO	18.75"	DIAMETRO	11.6"
<p>BUICK</p> <p>LESABRE 00-05 ELDORADO 98-02</p>		<p>BUICK</p> <p>LESABRE 00-05 ELDORADO 98-02</p>		<p>SUBARU</p> <p>LEGACY 2.5 GT 05</p>	
<p>CADILLAC</p> <p>SEVILLE STS 02-04 96-97</p>		<p>CADILLAC</p> <p>SEVILLE STS 02-04 96-97</p>		<p>OUTBACK 00-04</p>	
<p>DEVILLE 00-05</p>		<p>DEVILLE 00-05</p>			









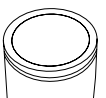

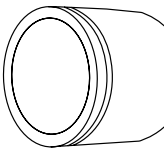



Fotografías de producto y especificaciones

No. Lusac: 381389 Producto: MANGUERA DE FRENOS 		No. Lusac: 381390 Producto: MANGUERA DE FRENOS  Imagen Disponible Próximamente		No. Lusac: 381391 Producto: MANGUERA DE FRENOS 	
DIAMETRO	16.35"	DIAMETRO	13.9"	DIAMETRO	18.5"
VOLKSWAGEN PASSAT VAGONETA 96-97		FORD MUSTANG GT 99-04		CADILLAC DEVILLE 05-05	
No. Lusac: 381455 Producto: MANGUERA DE FRENOS 		No. Lusac: 381458 Producto: MANGUERA DE FRENOS 		No. Lusac: 381466 Producto: MANGUERA DE FRENOS 	
DIAMETRO	10.55"	DIAMETRO	8.15"	DIAMETRO	21.88"
TOYOTA COROLLA LE, XRS, S, CE 02-08 PRIUS 01-06 MATRIX XR 03-08		PONTIAC AZTEK 01-05		HONDA CIVIC 02-06	
No. Lusac: 381467 Producto: MANGUERA DE FRENOS 		No. Lusac: 381468 Producto: MANGUERA DE FRENOS 		No. Lusac: 381469 Producto: MANGUERA DE FRENOS 	
DIAMETRO	21.88"	DIAMETRO	15.75"	DIAMETRO	15.75"
HONDA CIVIC 02-06		TOYOTA CAMRY LE 02-06		TOYOTA CAMRY LE 02-06	







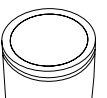

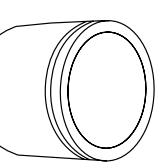



No. Lusac: 381475 Producto: MANGUERA DE FRENOS		No. Lusac: 381499 Producto: MANGUERA DE FRENOS		No. Lusac: 381500 Producto: MANGUERA DE FRENOS	
					
DIAMETRO	22.13"	DIAMETRO	12.13"	DIAMETRO	10.25"
DODGE RAM 2500 01-02		ACURA 3.2TL 06 TL 07-08		HONDA CIVIC 02-06 FIT 06-08	
No. Lusac: 381501 Producto: MANGUERA DE FRENOS		No. Lusac: 381502 Producto: MANGUERA DE FRENOS		No. Lusac: 381503 Producto: MANGUERA DE FRENOS	
					
DIAMETRO	11.25"	DIAMETRO	13.05"	DIAMETRO	7.82"
MITSUBISHI LANCER 04-10 OUTLANDER 03-08		AUDI A4 01-09 S4 02 04-09		AUDI A6 98-06 S6 01-04	
No. Lusac: 381510 Producto: MANGUERA DE FRENOS		No. Lusac: 381513 Producto: MANGUERA DE FRENOS		No. Lusac: 381514 Producto: MANGUERA DE FRENOS	
					
DIAMETRO	12.13"	DIAMETRO	25.37"	DIAMETRO	25.67"
BMW 525i 01-03		DODGE RAM 1500 02		DODGE RAM 2500 HD 09-11	





Fotografías de producto y especificaciones

No. Lusac: 381534 Producto: MANGUERA DE FRENOS 		No. Lusac: 381544 Producto: MANGUERA DE FRENOS 		No. Lusac: 381545 Producto: MANGUERA DE FRENOS 	
DIAMETRO	13.63"	DIAMETRO	17.62"	DIAMETRO	17.62"
PONTIAC AZTEK 01-05		ACURA TL 07-08		HONDA ACCORD 03-07	
No. Lusac: 381546 Producto: MANGUERA DE FRENOS 		No. Lusac: 381547 Producto: MANGUERA DE FRENOS 		No. Lusac: 381550 Producto: MANGUERA DE FRENOS 	
DIAMETRO	18.62"	DIAMETRO	18.62"	DIAMETRO	17.12"
HONDA ACCORD 03-07		HONDA ACCORD 03-07		ACURA 3.2TL 04-06 TL 07-08	
No. Lusac: 381551 Producto: MANGUERA DE FRENOS 		No. Lusac: 381554 Producto: MANGUERA DE FRENOS 		No. Lusac: 381555 Producto: MANGUERA DE FRENOS 	
DIAMETRO	17.12"	DIAMETRO	17.62"	DIAMETRO	23.13"
ACURA 3.2TL 04-06 TL 07-08		HONDA CIVIC 03-05		HONDA CIVIC 03-05	

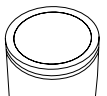

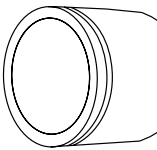



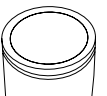

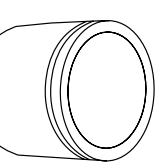



No. Lusac: 381556		No. Lusac: 381557		No. Lusac: 381566	
Producto: MANGUERA DE FRENOS		Producto: MANGUERA DE FRENOS		Producto: MANGUERA DE FRENOS	
DIAMETRO	23"	DIAMETRO	23"	DIAMETRO	18.62"
HONDA		HONDA		HONDA	
CIVIC EX 01-05		CIVIC EX 01-05		CIVIC 03-06	
No. Lusac: 381567		No. Lusac: 381580		No. Lusac: 381581	
Producto: MANGUERA DE FRENOS		Producto: MANGUERA DE FRENOS		Producto: MANGUERA DE FRENOS	
DIAMETRO	18.62"	DIAMETRO	13.28"	DIAMETRO	13.28"
HONDA		NISSAN		NISSAN	
CIVIC 03-06		SENTRA 01-06		SENTRA 01-06	
No. Lusac: 381586		No. Lusac: 381587		No. Lusac: 381588	
Producto: MANGUERA DE FRENOS		Producto: MANGUERA DE FRENOS		Producto: MANGUERA DE FRENOS	
DIAMETRO	14.45"	DIAMETRO	6.55"	DIAMETRO	23.25"
ACURA		ACURA		INFINITI	
MDX 01-06		MDX 01-06		I35 02-03	
HONDA				NISSAN	
PILOT 03-08				MAXIMA 02-03	









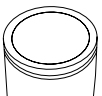

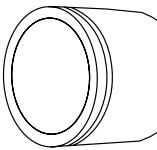



Fotografías de producto y especificaciones

No. Lusac: 381589 Producto: MANGUERA DE FRENOS 		No. Lusac: 381590 Producto: MANGUERA DE FRENOS 		No. Lusac: 381591 Producto: MANGUERA DE FRENOS 	
DIAMETRO	24.38"	DIAMETRO	18.37"	DIAMETRO	19.5"
INFINITI I35 02-03		NISSAN MAXIMA 02-03		NISSAN SENTRA SE-R 01-06	
No. Lusac: 381592 Producto: MANGUERA DE FRENOS 		No. Lusac: 381593 Producto: MANGUERA DE FRENOS 		No. Lusac: 381594 Producto: MANGUERA DE FRENOS 	
DIAMETRO	21.5"	DIAMETRO	22.62"	DIAMETRO	20.5"
NISSAN SENTRA SE-R 02-06		NISSAN SENTRA SE-R 02-06		NISSAN ALTIMA 02-06 MAXIMA SE 07-08	
No. Lusac: 381595 Producto: MANGUERA DE FRENOS 		No. Lusac: 381607 Producto: MANGUERA DE FRENOS 		No. Lusac: 381610 Producto: MANGUERA DE FRENOS 	
DIAMETRO	21.5"	DIAMETRO	9.35"	DIAMETRO	15.12"
NISSAN ALTIMA 02-06 MAXIMA SE 07-08		TOYOTA SIENNA 04-06		TOYOTA MR2 05-06	







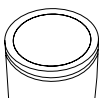

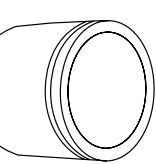



<p>No. Lusac: 381611</p> <p>Producto: MANGUERA DE FRENOS</p> 		<p>No. Lusac: 381612</p> <p>Producto: MANGUERA DE FRENOS</p> 		<p>No. Lusac: 381613</p> <p>Producto: MANGUERA DE FRENOS</p> 	
DIAMETRO	15.12"	DIAMETRO	14"	DIAMETRO	11.25"
<p>TOYOTA</p> <p>MR2 05-06</p>		<p>TOYOTA</p> <p>LAND CRUISER 13-14</p> <p>LANDCRUISER 04-12</p>		<p>TOYOTA</p> <p>4RUNNER 03-09</p> <p>FJ CRUISER PREMIUM 07-14</p>	
<p>No. Lusac: 381614</p> <p>Producto: MANGUERA DE FRENOS</p> 		<p>No. Lusac: 381621</p> <p>Producto: MANGUERA DE FRENOS</p> 		<p>No. Lusac: 381622</p> <p>Producto: MANGUERA DE FRENOS</p> 	
DIAMETRO	12.88"	DIAMETRO	9"	DIAMETRO	8.92"
<p>TOYOTA</p> <p>FJ CRUISER 07</p>		<p>CHEVROLET PONTIAC</p> <p>AVEO 08-14 G3 07-09</p>		<p>CHEVROLET</p> <p>TRACKER 00-02</p>	
<p>No. Lusac: 381623</p> <p>Producto: MANGUERA DE FRENOS</p> 		<p>No. Lusac: 381624</p> <p>Producto: MANGUERA DE FRENOS</p> 		<p>No. Lusac: 381634</p> <p>Producto: MANGUERA DE FRENOS</p> 	
DIAMETRO	18.3"	DIAMETRO	12.75"	DIAMETRO	9.7"
<p>CADILLAC</p> <p>DEVILLE 05</p>		<p>CHEVROLET</p> <p>SILVERADO 3500 01-06</p>		<p>CHEVROLET</p> <p>HHR 06-09 G5 07-09</p> <p>PONTIAC</p> <p>G4 05-06</p>	









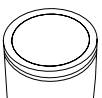

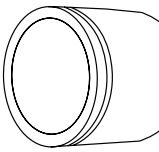



Fotografías de producto y especificaciones

No. Lusac: 381639 Producto: MANGUERA DE FRENOS 		No. Lusac: 381640 Producto: MANGUERA DE FRENOS 		No. Lusac: 381643 Producto: MANGUERA DE FRENOS 	
DIAMETRO	10.87"	DIAMETRO	10.87"	DIAMETRO	20.63"
PONTIAC TORRENT 06-09		PONTIAC TORRENT 06-09		FORD EXPLORER SPORT TRAC 01-02	
No. Lusac: 381646 Producto: MANGUERA DE FRENOS 		No. Lusac: 381647 Producto: MANGUERA DE FRENOS 		No. Lusac: 381648 Producto: MANGUERA DE FRENOS 	
DIAMETRO	18.5"	DIAMETRO	18.75"	DIAMETRO	23.12"
TOYOTA CAMRY LE 02-06 SOLARA 04-08		TOYOTA CAMRY LE 02-06 SOLARA 04-08		TOYOTA CAMRY LE 02-06 SOLARA 05-06	
No. Lusac: 381649 Producto: MANGUERA DE FRENOS 		No. Lusac: 381650 Producto: MANGUERA DE FRENOS 		No. Lusac: 381651 Producto: MANGUERA DE FRENOS 	
DIAMETRO	23.12"	DIAMETRO	13.25"	DIAMETRO	13.25"
TOYOTA CAMRY LE 02-06 SOLARA 04-06		INFINITI G35 05		NISSAN 350Z 03-08	
		NISSAN 350Z 03-08		INFINITI G35 05	







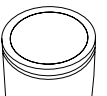

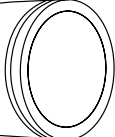



<p>No. Lusac: 381652</p> <p>Producto: MANGUERA DE FRENOS</p> 		<p>No. Lusac: 381653</p> <p>Producto: MANGUERA DE FRENOS</p> 		<p>No. Lusac: 381656</p> <p>Producto: MANGUERA DE FRENOS</p> 	
DIAMETRO	16.25"	DIAMETRO	20.25"	DIAMETRO	8.13"
<p>NISSAN</p> <p>PATHFINDER 03</p>		<p>NISSAN</p> <p>FRONTIER 03 TITAN 04-05</p>		<p>TOYOTA</p> <p>SIENNA 04-10</p>	
<p>No. Lusac: 381658</p> <p>Producto: MANGUERA DE FRENOS</p> 		<p>No. Lusac: 381659</p> <p>Producto: MANGUERA DE FRENOS</p> 		<p>No. Lusac: 381660</p> <p>Producto: MANGUERA DE FRENOS</p> 	
DIAMETRO	16.38"	DIAMETRO	21.5"	DIAMETRO	21.5"
<p>CHRYSLER</p> <p>CROSSFIRE 04-06 04-06</p> <p>FORD</p> <p>E350 10-14</p> <p>MERCEDEZ BENZ</p> <p>C230 06-09</p> <p>C300 08-11</p> <p>C350 06-14</p> <p>C55AMG 05-07</p> <p>CLK320 98-05</p> <p>CLK350 06-09</p> <p>CLK500 03-06 03-06</p> <p>CLK55AMG 01-06</p> <p>CLK63AMG 08-09</p> <p>SLK350 05-14</p> <p>SLK55 AMG 08-14</p> <p>SLK55 AMG 13-14</p>		<p>NISSAN</p> <p>MAXIMA 02-03</p>		<p>NISSAN</p> <p>MAXIMA 02-03</p>	
<p>No. Lusac: 381661</p> <p>Producto: MANGUERA DE FRENOS</p> 		<p>No. Lusac: 381673</p> <p>Producto: MANGUERA DE FRENOS</p> 		<p>No. Lusac: 381674</p> <p>Producto: MANGUERA DE FRENOS</p> 	
DIAMETRO	12.13"	DIAMETRO	24.31"	DIAMETRO	24.31"
<p>CHRYSLER</p> <p>CROSSFIRE 04-06 04-06</p>		<p>TOYOTA</p> <p>COROLLA S 05-08 MATRIX XR 03-08</p>		<p>TOYOTA</p> <p>COROLLA S 05-08 MATRIX XR 03-08</p>	









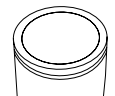

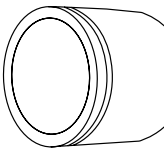



Fotografías de producto y especificaciones

No. Lusac: 381676 Producto: MANGUERA DE FRENOS 		No. Lusac: 381677 Producto: MANGUERA DE FRENOS 		No. Lusac: 382300 Producto: MANGUERA DE FRENOS 	
DIAMETRO	20.31"	DIAMETRO	15.38"	DIAMETRO	27.1"
TOYOTA SIENNA 04-10		CHEVROLET SUBURBAN 1500 04-06		FORD F150 00-03	
No. Lusac: 382302 Producto: MANGUERA DE FRENOS 		No. Lusac: 382304 Producto: MANGUERA DE FRENOS 		No. Lusac: 382305 Producto: MANGUERA DE FRENOS 	
DIAMETRO	18"	DIAMETRO	43"	DIAMETRO	39"
NISSAN FRONTIER 02-04 XTERRA 03-04		DODGE RAM 1500 00-01 RAM 3500 00-01 RAM 2500 HEAVY DUTY 00-01		DODGE RAM 1500 00-01 RAM 2500 01	
No. Lusac: 382306 Producto: MANGUERA DE FRENOS 		No. Lusac: 382307 Producto: MANGUERA DE FRENOS 		No. Lusac: 382308 Producto: MANGUERA DE FRENOS 	
DIAMETRO	17.5"	DIAMETRO	17.5"	DIAMETRO	19.38"
CHRYSLER PT CRUISER 01-10		CHRYSLER PT CRUISER 03-10		CHRYSLER DODGE 300 06-12 CHARGER RT DAYTONA SXT 06-10 300C 05-10	







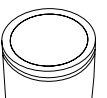

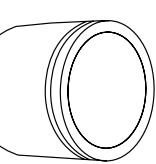



No. Lusac: 382309		No. Lusac: 382310		No. Lusac: 382311	
Producto: MANGUERA DE FRENOS		Producto: MANGUERA DE FRENOS		Producto: MANGUERA DE FRENOS	
					
DIAMETRO	22.5"	DIAMETRO	22.45"	DIAMETRO	17.71"
JEEP		JEEP		JEEP	
LIBERTY 02-04 07-08 05-06		LIBERTY 02-08		LIBERTY 02-06	
No. Lusac: 382312		No. Lusac: 382313		No. Lusac: 382314	
Producto: MANGUERA DE FRENOS		Producto: MANGUERA DE FRENOS		Producto: MANGUERA DE FRENOS	
					
DIAMETRO	17.75"	DIAMETRO	17.75"	DIAMETRO	9.86"
CHRYSLER		CHRYSLER		CHRYSLER	
PT CRUISER 01-10		PT CRUISER 01-10		PT CRUISER 01-05	
No. Lusac: 382315		No. Lusac: 382316		No. Lusac: 382317	
Producto: MANGUERA DE FRENOS		Producto: MANGUERA DE FRENOS		Producto: MANGUERA DE FRENOS	
					
DIAMETRO	14.32"	DIAMETRO	11.32"	DIAMETRO	9.86"
CHRYSLER		CHRYSLER		CHRYSLER	
PT CRUISER 01-10		PT CRUISER 01-10		PT CRUISER 01-05	





Fotografías de producto y especificaciones

No. Lusac: 382319 Producto: MANGUERA DE FRENOS		No. Lusac: 382320 Producto: MANGUERA DE FRENOS		No. Lusac: 382321 Producto: MANGUERA DE FRENOS	
					
DIAMETRO	25"	DIAMETRO	24.75"	DIAMETRO	43"
CHEVROLET GMC EXPRESS 3500 CARGO VAN EXT 97-03 SAVANA 3500 EXT 96-02		CHEVROLET GMC EXPRESS 3500 CARGO VAN EXT 97-03 SAVANA 3500 EXT 96-02		JEEP GRAND CHEROKEE 99-05	
No. Lusac: 382322 Producto: MANGUERA DE FRENOS		No. Lusac: 382323 Producto: MANGUERA DE FRENOS		No. Lusac: 382324 Producto: MANGUERA DE FRENOS	
					
DIAMETRO	43"	DIAMETRO	43.25"	DIAMETRO	42.0"
JEEP GRAND CHEROKEE 99-05		DODGE RAM 1500 00-02 RAM 3500 00-02 RAM 2500 02		DODGE RAM 1500 00-02 RAM 3500 00-02 RAM 2500 02	
No. Lusac: 382325 Producto: MANGUERA DE FRENOS		No. Lusac: 382326 Producto: MANGUERA DE FRENOS		No. Lusac: 382327 Producto: MANGUERA DE FRENOS	
					
DIAMETRO	18.5"	DIAMETRO	18.5"	DIAMETRO	21.38"
CHRYSLER NEON SRT4 00-05		CHRYSLER NEON SRT4 00-05		CHRYSLER NEON SRT4 03-05	

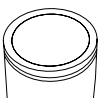

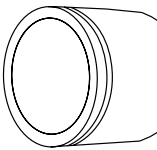



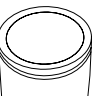

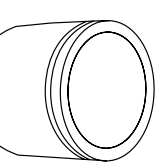

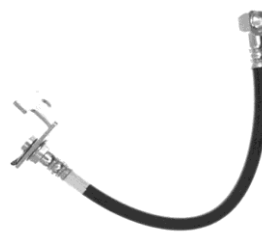

No. Lusac: 382328		No. Lusac: 382329		No. Lusac: 382330	
Producto: MANGUERA DE FRENOS		Producto: MANGUERA DE FRENOS		Producto: MANGUERA DE FRENOS	
DIAMETRO	21.38"	DIAMETRO	21.5"	DIAMETRO	21"
CHRYSLER		FORD		FORD	
NEON SRT4 003-05		MUSTANG 05-14		MUSTANG 05-14	
No. Lusac: 382331		No. Lusac: 382332		No. Lusac: 382333	
Producto: MANGUERA DE FRENOS		Producto: MANGUERA DE FRENOS		Producto: MANGUERA DE FRENOS	
DIAMETRO	21"	DIAMETRO	21.5"	DIAMETRO	12.38"
FORD		FORD		FORD	
MUSTANG 05-08		MUSTANG 05-08		MUSTANG 05-14	
No. Lusac: 382334		No. Lusac: 382335		No. Lusac: 382336	
Producto: MANGUERA DE FRENOS		Producto: MANGUERA DE FRENOS		Producto: MANGUERA DE FRENOS	
DIAMETRO	12.38"	DIAMETRO	12.38"	DIAMETRO	12.38"
FORD		FORD		FORD	
MUSTANG 05-14		MUSTANG 06-10		MUSTANG 06-10	





Fotografías de producto y especificaciones

No. Lusac: 382337		No. Lusac: 382338		No. Lusac: 382339	
Producto: MANGUERA DE FRENOS		Producto: MANGUERA DE FRENOS		Producto: MANGUERA DE FRENOS	
					
DIAMETRO	13.38"	DIAMETRO	13.38"	DIAMETRO	55.5"
CHEVROLET		CHEVROLET		CHRYSLER	
MALIBU 02-04		MALIBU 02-04		TOWN & COUNTRY 01-07 GRAND CARAVAN 01-02	
				DODGE	
				CARAVAN 03-07	
No. Lusac: 382342		No. Lusac: 382344		No. Lusac: 382345	
Producto: MANGUERA DE FRENOS		Producto: MANGUERA DE FRENOS		Producto: MANGUERA DE FRENOS	
					
DIAMETRO	37.38"	DIAMETRO	37.38"	DIAMETRO	55.5"
CHRYSLER		CHRYSLER		CHRYSLER	
TOWN & COUNTRY 05-06 GRAND CARAVAN 05		TOWN & COUNTRY 05-06 GRAND CARAVAN 05		TOWN & COUNTRY 01-04 GRAND CARAVAN 01-02	
DODGE		DODGE		DODGE	
No. Lusac: 382346		No. Lusac: 382347		No. Lusac: 382348	
Producto: MANGUERA DE FRENOS		Producto: MANGUERA DE FRENOS		Producto: MANGUERA DE FRENOS	
					
DIAMETRO	33.5"	DIAMETRO	37"	DIAMETRO	37"
CHRYSLER		CHRYSLER		CHRYSLER	
TOWN & COUNTRY 01-04 GRAND CARAVAN 03-05		TOWN & COUNTRY 01-07 GRAND CARAVAN 01-06		GRAND VOYAGER 01-02 CARAVAN 01-07	
		DODGE		DODGE	
		CARAVAN 05-07		TOWN & COUNTRY 01-04 GRAND CARAVAN 01-05	
				VOYAGER 01-04	

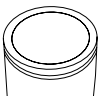

Fotografías de producto y especificaciones

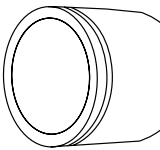



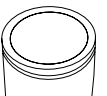

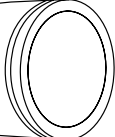



No. Lusac: 382350		No. Lusac: 382351		No. Lusac: 382352	
Producto: MANGUERA DE FRENOS		Producto: MANGUERA DE FRENOS		Producto: MANGUERA DE FRENOS	
DIAMETRO	35.5"	DIAMETRO	14.75"	DIAMETRO	14.75"
CHRYSLER GRAND VOYAGER 01-02 TOWN & COUNTRY 01-04		CHRYSLER SEBRING 03-06 STRATUS 03-06		CHRYSLER SEBRING 03-06 STRATUS 03-06	
No. Lusac: 382354		No. Lusac: 382355		No. Lusac: 382356	
Producto: MANGUERA DE FRENOS		Producto: MANGUERA DE FRENOS		Producto: MANGUERA DE FRENOS	
DIAMETRO	23"	DIAMETRO	18.13"	DIAMETRO	19.13"
DODGE DAKOTA LARAMIE 05-11		CHRYSLER 300 11-13 300C 05		DODGE CHALLENGER R/T 11-13 CHARGER DAYTONA RT SXT 07-10	
CHRYSLER GRAND CARAVAN 01-04		DODGE CHARGER RT DAYTONA SXT 07-10		CHRYSLER 300 06-09 13-13 300C 05-10 12	
No. Lusac: 382357		No. Lusac: 382358		No. Lusac: 382359	
Producto: MANGUERA DE FRENOS		Producto: MANGUERA DE FRENOS		Producto: MANGUERA DE FRENOS	
DIAMETRO	18.31"	DIAMETRO	19.13"	DIAMETRO	18.31"
CHRYSLER 300 10 12-14 300C 05-09		CHRYSLER 300 06-09 300C 05-10 12		DODGE CHALLENGER R/T SRT8 08-13 CHARGER RT DAYTONA SXT 06-10	
DODGE CHALLENGER R/T SRT8 08-14 CHARGER RT DAYTONA SXT 06-10		DODGE CHARGER RT DAYTONA SXT 07-10		DODGE CHALLENGER R/T SRT8 08-13 CHARGER RT DAYTONA SXT 06-10	



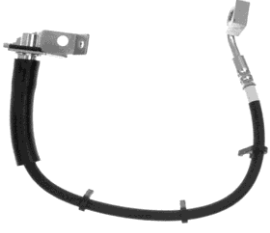





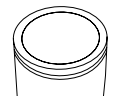

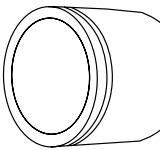

Fotografías de producto y especificaciones

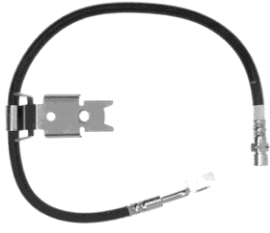
No. Lusac: 382360		No. Lusac: 382361		No. Lusac: 382362	
Producto: MANGUERA DE FRENOS		Producto: MANGUERA DE FRENOS		Producto: MANGUERA DE FRENOS	
					
DIAMETRO	17.38"	DIAMETRO	17.38"	DIAMETRO	19.62"
CHRYSLER		CHRYSLER		CHRYSLER	
DODGE		DODGE		CHRYSLER	
300C SRT-8 06-08 12		300C SRT-8 06-08 10 12		PACIFICA TOURING 04-08	
CHARGER SRT8 07-10		CHARGER SRT8 07-10			
No. Lusac: 382363		No. Lusac: 382364		No. Lusac: 382365	
Producto: MANGUERA DE FRENOS		Producto: MANGUERA DE FRENOS		Producto: MANGUERA DE FRENOS	
					
DIAMETRO	22"	DIAMETRO	20.38"	DIAMETRO	19.38"
CHEVROLET		CHEVROLET		CHEVROLET	
DODGE		DODGE		TOYOTA	
SUBURBAN 2500 07-13		SUBURBAN 2500 07-13		SUBURBAN 2500 07-13	
DURANGO 04-09		RAM 2500 HD 09-14		CAMRY 07-11	
CHRYSLER		RAM MEGA CAB LARAMIE 06-08			
ASPEN 07-09		RAM 1500 ST 05-10 12			
No. Lusac: 382366		No. Lusac: 382367		No. Lusac: 382368	
Producto: MANGUERA DE FRENOS		Producto: MANGUERA DE FRENOS		Producto: MANGUERA DE FRENOS	
					
DIAMETRO	25.5"	DIAMETRO	25.5"	DIAMETRO	18.75"
CHEVROLET		CHRYSLER		CHRYSLER	
DODGE		DODGE			
SUBURBAN 2500 07-13		GRAND VOYAGER 01-02		PACIFICA TOURING 04-08	
CARAVAN 01-07		CARAVAN 01-07			
CHRYSLER		TOWN & COUNTRY 01-07			
GRAND CARAVAN 01-07		GRAND CARAVAN 01-07			
GRAND VOYAGER 01-02		VOYAGER 01-08			
TOWN & COUNTRY 01-07					
VOYAGER 01-08					







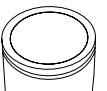

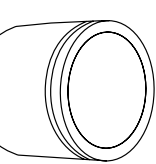



No. Lusac: 382371 Producto: MANGUERA DE FRENOS		No. Lusac: 382372 Producto: MANGUERA DE FRENOS		No. Lusac: 382373 Producto: MANGUERA DE FRENOS	
 <p>Imagen Disponible Próximamente</p>					
DIAMETRO	25.81"	DIAMETRO	25.25"	DIAMETRO	25.75"
CHRYSLER DODGE		CHRYSLER DODGE		CHRYSLER DODGE	
300 06-09 11	CHARGER RT DAYTONA SXT 06-10	300 10 12	CHALLENGER R/T 09-14	300 13-14	CHALLENGER SRT8 08-11
300C 05		300C 05-10 12-12	CHARGER RT DAYTONA SXT 06-10	300C SRT-8 06-08	CHARGER SRT8 07-14
No. Lusac: 382374 Producto: MANGUERA DE FRENOS		No. Lusac: 382375 Producto: MANGUERA DE FRENOS		No. Lusac: 382376 Producto: MANGUERA DE FRENOS	
					
DIAMETRO	25.75"	DIAMETRO	25.38"	DIAMETRO	22.13"
CHRYSLER DODGE		CHRYSLER DODGE		CHRYSLER DODGE	
300 06-09 11	CHARGER RT DAYTONA SXT SXT 06-10	300 10 12	CHALLENGER R/T 09-14	300 13-14	CHALLENGER SRT8 08-11
300C 05		300C 05-10 12	CHARGER RT DAYTONA SXT 06-10	300C SRT-8 06-08	CHARGER SRT8 07-14
No. Lusac: 382377 Producto: MANGUERA DE FRENOS		No. Lusac: 382378 Producto: MANGUERA DE FRENOS		No. Lusac: 382379 Producto: MANGUERA DE FRENOS	
					
DIAMETRO	34.25"	DIAMETRO	33"	DIAMETRO	20.25"
DODGE RAM 1500 ST 05-10 RAM 2500 HD 09-14		DODGE RAM 1500 06-08		DODGE RAM 1500 06-08 12 RAM 2500 HD 09-12	





Fotografías de producto y especificaciones

No. Lusac: 382380 Producto: MANGUERA DE FRENOS 		No. Lusac: 382381 Producto: MANGUERA DE FRENOS 		No. Lusac: 382382 Producto: MANGUERA DE FRENOS 	
DIAMETRO	30.38"	DIAMETRO	30.38"	DIAMETRO	38.5"
DODGE RAM 1500 02-04		DODGE RAM 1500 02-06		CHRYSLER GRAND VOYAGER 01-02 VOYAGER 01-04	
No. Lusac: 382383 Producto: MANGUERA DE FRENOS 		No. Lusac: 382384 Producto: MANGUERA DE FRENOS 		No. Lusac: 382385 Producto: MANGUERA DE FRENOS 	
DIAMETRO	30.38"	DIAMETRO	21.5"	DIAMETRO	9.38"
DODGE RAM 1500 02-04		FORD LINCOLN EXPEDITION 03-06 NAVIGATOR 03-06		FORD MERCURY FIVE HUNDRED 05-07 MONTEGO 05-07	
No. Lusac: 382387 Producto: MANGUERA DE FRENOS 		No. Lusac: 382388 Producto: MANGUERA DE FRENOS 		No. Lusac: 382389 Producto: MANGUERA DE FRENOS 	
DIAMETRO	18.13"	DIAMETRO	18.25"	DIAMETRO	21.63"
FORD MERCURY ESCAPE 05-08 MARINER 05-07		FORD MERCURY ESCAPE 05-08 MARINER 05-07		CHRYSLER MERCURY PT CRUISER 04-10 MONTEGO 05-07 FORD FIVE HUNDRED 05-07	

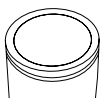

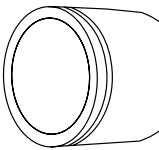



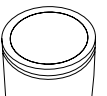

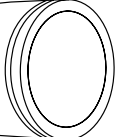



No. Lusac: 382390		No. Lusac: 382391		No. Lusac: 382392	
Producto: MANGUERA DE FRENOS		Producto: MANGUERA DE FRENOS		Producto: MANGUERA DE FRENOS	
DIAMETRO	21.63"	DIAMETRO	15.63"	DIAMETRO	8.69"
CHRYSLER PT CRUISER 04-10 FORD FIVE HUNDRED 05-07		MERCURY MONTEGO 05-07		FORD FOCUS EUROPA LX 05-07	
No. Lusac: 382393		No. Lusac: 382394		No. Lusac: 382395	
Producto: MANGUERA DE FRENOS		Producto: MANGUERA DE FRENOS		Producto: MANGUERA DE FRENOS	
DIAMETRO	17.5"	DIAMETRO	24"	DIAMETRO	24"
FORD FOCUS EUROPA LX 05-07		LINCOLN AVIATOR 03-05		LINCOLN AVIATOR 03-05	
No. Lusac: 382396		No. Lusac: 382397		No. Lusac: 382398	
Producto: MANGUERA DE FRENOS		Producto: MANGUERA DE FRENOS		Producto: MANGUERA DE FRENOS	
DIAMETRO	16.38"	DIAMETRO	19"	DIAMETRO	17.19"
CHEVROLET SILVERADO 1500 02 SILVERADO 2500 CHEYENNE 02		GMC SIERRA 1500HD CLASSIC 07		CHEVROLET SILVERADO 1500 02 SILVERADO 2500 CHEYENNE 02	









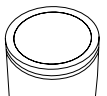

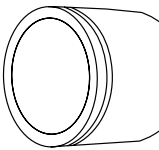



Fotografías de producto y especificaciones

No. Lusac: 382399 Producto: MANGUERA DE FRENOS 		No. Lusac: 382405 Producto: MANGUERA DE FRENOS 		No. Lusac: 382406 Producto: MANGUERA DE FRENOS 	
DIAMETRO	22"	DIAMETRO	15.38"	DIAMETRO	18.5"
CHEVROLET C2500 96-99 SILVERADO 2500HD 02 SILVERADO 3500 01-06 SUBURBAN 2500 00-06		GMC SIERRA 03 SIERRA 2500 02 04 SIERRA 2500HD CLASSIC 02-07		CHEVROLET CORVETTE 97-04	
CHEVROLET SILVERADO 1500 00-01		GMC SIERRA 1500 01			
No. Lusac: 382412 Producto: MANGUERA DE FRENOS 		No. Lusac: 382414 Producto: MANGUERA DE FRENOS 		No. Lusac: 382415 Producto: MANGUERA DE FRENOS 	
DIAMETRO	28.38"	DIAMETRO	27.38"	DIAMETRO	29.5"
CADILLAC ESCALADE 00-06 CHEVROLET C2500 96-99 SILVERADO 1500 02 SILVERADO 2500 CHEYENNE 02		SUBURBAN 1500 01-06 TAHOE 00-06 GMC SIERRA 1500 CLASSIC 07		CADILLAC ESCALADE 00-06 CHEVROLET SILVERADO 1500 02 SILVERADO 2500 CHEYENNE 02 SUBURBAN 1500 00-06	
CHEVROLET SILVERADO 1500 03-05		CHEVROLET SILVERADO 1500 02 SILVERADO 2500 CHEYENNE 02 SUBURBAN 1500 00-06		GMC SIERRA 1500 CLASSIC 07	
No. Lusac: 382416 Producto: MANGUERA DE FRENOS 		No. Lusac: 382417 Producto: MANGUERA DE FRENOS 		No. Lusac: 382418 Producto: MANGUERA DE FRENOS 	
DIAMETRO	30.5"	DIAMETRO	31.25"	DIAMETRO	30.75"
CHEVROLET SILVERADO 1500 03-05		CHEVROLET SILVERADO 1500HD 02 SILVERADO 2500HD 02 SILVERADO 3500 01-06 SUBURBAN 2500 00-06 GMC SIERRA 03		SIERRA 1500HD CLASSIC 01-07 SIERRA 2500 99-02 04 SIERRA 2500HD 01-07 HUMMER H2 SUT 05-07	
				GMC SIERRA 1500 CLASSIC 07	







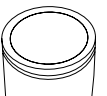

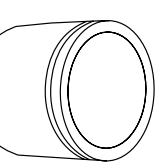



<p>No. Lusac: 382419</p> <p>Producto: MANGUERA DE FRENOS</p> 		<p>No. Lusac: 382422</p> <p>Producto: MANGUERA DE FRENOS</p> 		<p>No. Lusac: 382423</p> <p>Producto: MANGUERA DE FRENOS</p> 	
DIAMETRO	31.25"	DIAMETRO	24.38"	DIAMETRO	24.38"
<p>CHEVROLET</p> <p>SILVERADO 1500HD 02 SIERRA 1500HD CLASSIC 01-07</p> <p>SILVERADO 2500HD 02 SIERRA 2500 99-02 04</p> <p>SILVERADO 3500 01-06 SIERRA 2500HD CLASSIC 01-07</p> <p>SUBURBAN 2500 00-06 HUMMER</p> <p>GMC H2 SUT 05-07</p> <p>SIERRA 03</p>		<p>TOYOTA</p> <p>COROLLA 03-08</p> <p>PRIUS 04-09</p>		<p>TOYOTA</p> <p>COROLLA 03-08</p> <p>PRIUS 04-09</p>	
<p>No. Lusac: 382426</p> <p>Producto: MANGUERA DE FRENOS</p> 		<p>No. Lusac: 382427</p> <p>Producto: MANGUERA DE FRENOS</p> 		<p>No. Lusac: 382428</p> <p>Producto: MANGUERA DE FRENOS</p> 	
DIAMETRO	18.63"	DIAMETRO	23.75"	DIAMETRO	19.25"
<p>HONDA</p> <p>RIDGELINE 06-14 07-14</p>		<p>HONDA</p> <p>CR-V 02-06</p>		<p>HONDA</p> <p>CR-V 02-04</p>	
<p>No. Lusac: 382429</p> <p>Producto: MANGUERA DE FRENOS</p> 		<p>No. Lusac: 382450</p> <p>Producto: MANGUERA DE FRENOS</p> 		<p>No. Lusac: 382453</p> <p>Producto: MANGUERA DE FRENOS</p> 	
DIAMETRO	28.75"	DIAMETRO	22.72"	DIAMETRO	15.35"
<p>BMW</p> <p>525I 01-03 M5 99-03</p> <p>528IA 96-00</p> <p>540I 97-03</p>		<p>ACURA LAND ROVER</p> <p>RL 07-12 DISCOVERY 00-04</p>		<p>AUDI</p> <p>A3 02-03 JETTA A4, EUROPA, TDI, TRENDLINE 02-10</p> <p>VOLKSWAGEN JETTA CLASICO 11-14</p> <p>BEETLE GLS GLX 00-10</p> <p>GOLF A3GTI 07-08 A4 GTI 01</p>	





Fotografías de producto y especificaciones

No. Lusac: 382455		No. Lusac: 382456		No. Lusac: 382458	
Producto: MANGUERA DE FRENOS		Producto: MANGUERA DE FRENOS		Producto: MANGUERA DE FRENOS	
					
DIAMETRO	15.75"	DIAMETRO	23.25"	DIAMETRO	32.5"
CHEVROLET HHR 06-09 PONTIAC G4 05-06		NISSAN QUEST 04-09		DODGE RAM 2500 HD 09-12	
No. Lusac: 382460		No. Lusac: 382461		No. Lusac: 382462	
Producto: MANGUERA DE FRENOS		Producto: MANGUERA DE FRENOS		Producto: MANGUERA DE FRENOS	
					
DIAMETRO	11 9/16"	DIAMETRO	10.5"	DIAMETRO	17.38"
FORD ESCAPE 01-08		FORD ESCAPE 01-08		FORD ESCAPE 01-08	
MERCURY MARINER 05-07		MERCURY MARINER 05-07		MERCURY MARINER 05-07	
No. Lusac: 382463		No. Lusac: 382464		No. Lusac: 382468	
Producto: MANGUERA DE FRENOS		Producto: MANGUERA DE FRENOS		Producto: MANGUERA DE FRENOS	
					
DIAMETRO	19.25"	DIAMETRO	20"	DIAMETRO	20.5"
CADILLAC CTS 03-07		CADILLAC CTS 03-07		FORD GRAND MARQUIS 03-04	
				LINCOLN TOWN CAR 08-11	

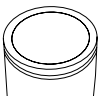

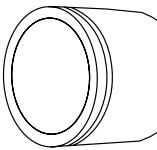



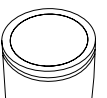

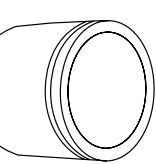



No. Lusac: 382469		No. Lusac: 382476		No. Lusac: 382482	
Producto: MANGUERA DE FRENOS		Producto: MANGUERA DE FRENOS		Producto: MANGUERA DE FRENOS	
DIAMETRO	20.5"	DIAMETRO	27.5"	DIAMETRO	20.25"
FORD GRAND MARQUIS 03-04		FORD F150 99-03		FORD LINCOLN GRAND MARQUIS 03-04 TOWN CAR 08-09 11	
No. Lusac: 382483		No. Lusac: 382497		No. Lusac: 382498	
Producto: MANGUERA DE FRENOS		Producto: MANGUERA DE FRENOS		Producto: MANGUERA DE FRENOS	
DIAMETRO	20.25"	DIAMETRO	10.08"	DIAMETRO	17.62"
FORD LINCOLN GRAND MARQUIS 03-04 TOWN CAR 08-09 11		AUDI A3 04-13 PASSAT CC 03-12 VOLKSWAGEN PASSAT CC 11 BORA GLI TURBO 06-10		AUDI A8 01-10 S8 07-10	
No. Lusac: 382499		No. Lusac: 382500		No. Lusac: 382502	
Producto: MANGUERA DE FRENOS		Producto: MANGUERA DE FRENOS		Producto: MANGUERA DE FRENOS	
DIAMETRO	12.62"	DIAMETRO	16.2"	DIAMETRO	18.38"
BMW 530I 01-03		MERCEDEZ BENZ SPRINTER 04-06		BMW M3 01-06	









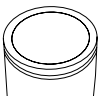

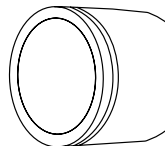



Fotografías de producto y especificaciones

No. Lusac: 382503 Producto: MANGUERA DE FRENOS 		No. Lusac: 382504 Producto: MANGUERA DE FRENOS 		No. Lusac: 382505 Producto: MANGUERA DE FRENOS 	
DIAMETRO	21.69"	DIAMETRO	21.31"	DIAMETRO	9.06"
BMW X3 04-10		BMW X3 04-10		BMW X5 07-14 X6 09-14	
No. Lusac: 382506 Producto: MANGUERA DE FRENOS 		No. Lusac: 382507 Producto: MANGUERA DE FRENOS 		No. Lusac: 382508 Producto: MANGUERA DE FRENOS 	
DIAMETRO	10.62"	DIAMETRO	14 1/16"	DIAMETRO	14"
BMW X5 07-14 X6 09-14		CHEVROLET AVEO 08-14		PONTIAC G3 07-09	
				CHEVROLET MALIBU 02-12	
				PONTIAC G6 05-09	
No. Lusac: 382509 Producto: MANGUERA DE FRENOS 		No. Lusac: 382510 Producto: MANGUERA DE FRENOS 		No. Lusac: 382518 Producto: MANGUERA DE FRENOS 	
DIAMETRO	11 1/16"	DIAMETRO	11 1/16"	DIAMETRO	24.25"
CHEVROLET BLAZER XTREME 02-05		CHEVROLET BLAZER XTREME 02-05		CHRYSLER PACIFICA TOURING 04-08	







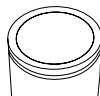

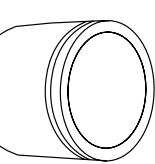



No. Lusac: 382519 Producto: MANGUERA DE FRENOS		No. Lusac: 382520 Producto: MANGUERA DE FRENOS		No. Lusac: 382521 Producto: MANGUERA DE FRENOS	
					
DIAMETRO	17.5"	DIAMETRO	17.5"	DIAMETRO	17.5"
CHRYSLER TOWN & COUNTRY 08-12 DODGE GRAND CARAVAN 08-12		VOLKSWAGEN ROUTAN 09-13		CHRYSLER 300C 05-09 TOWN & COUNTRY 08-09 VOYAGER 07-08 DODGE CHARGER RT DAYTONA SXT 06-10	
CHRYSLER TOWN & COUNTRY 08-12 DODGE GRAND CARAVAN 08-12		CHRYSLER TOWN & COUNTRY 08-12 DODGE GRAND CARAVAN 08-12		CHRYSLER 300C 05-09 TOWN & COUNTRY 08-09 VOYAGER 07-08 DODGE CHARGER RT DAYTONA SXT 06-10	
CHRYSLER TOWN & COUNTRY 08-09 VOYAGER 07-08 DODGE GRAND CARAVAN 08-11		VOLKSWAGEN ROUTAN 09-10		CHRYSLER GRAND CARAVAN 08-11 VOLKSWAGEN ROUTAN 09-10	
No. Lusac: 382522 Producto: MANGUERA DE FRENOS		No. Lusac: 382524 Producto: MANGUERA DE FRENOS		No. Lusac: 382525 Producto: MANGUERA DE FRENOS	
					
DIAMETRO	17.5"	DIAMETRO	13.7"	DIAMETRO	18.25"
CHRYSLER TOWN & COUNTRY 08-09 VOYAGER 07-08 DODGE GRAND CARAVAN 08-11		VOLKSWAGEN ROUTAN 09-10		DODGE DAKOTA LARAMIE LARAMIE 05-11	
CHRYSLER TOWN & COUNTRY 08-09 VOYAGER 07-08 DODGE GRAND CARAVAN 08-11		DODGE RAM 1500 06		DODGE DAKOTA LARAMIE LARAMIE 05-11	
No. Lusac: 382528 Producto: MANGUERA DE FRENOS		No. Lusac: 382529 Producto: MANGUERA DE FRENOS		No. Lusac: 382530 Producto: MANGUERA DE FRENOS	
					
DIAMETRO	19.75"	DIAMETRO	23"	DIAMETRO	(2)11.19"
DODGE RAM 1500 07-08		DODGE RAM 1500 07-09		DODGE RAM 1500 07-09	





Fotografías de producto y especificaciones

No. Lusac: 382533		No. Lusac: 382534		No. Lusac: 382535	
Producto: MANGUERA DE FRENOS		Producto: MANGUERA DE FRENOS		Producto: MANGUERA DE FRENOS	
					
DIAMETRO	16.12"	DIAMETRO	14.56"	DIAMETRO	14.56"
FORD		FORD		FORD	
FOCUS 06-07		FOCUS 08-11		FOCUS 08-11	
No. Lusac: 382536		No. Lusac: 382537		No. Lusac: 382538	
Producto: MANGUERA DE FRENOS		Producto: MANGUERA DE FRENOS		Producto: MANGUERA DE FRENOS	
					
DIAMETRO	20"	DIAMETRO	20"	DIAMETRO	20"
FORD		FORD		FORD LINCOLN	
EXPLORER EDDIE BAUER 03-05		EXPLORER EDDIE BAUER 03-05		EXPLORER EDDIE BAUER 01-05 AVIATOR 03-05	
No. Lusac: 382539		No. Lusac: 382540		No. Lusac: 382541	
Producto: MANGUERA DE FRENOS		Producto: MANGUERA DE FRENOS		Producto: MANGUERA DE FRENOS	
					
DIAMETRO	19.5"	DIAMETRO	17.5"	DIAMETRO	17.5"
FORD LINCOLN		FORD		FORD	
EXPEDITION 03-06 NAVIGATOR 03-06		EXPLORER EDDIE BAUER 06-10 EXPLORER SPORT TRAC 07-10		EXPLORER EDDIE BAUER 06-10 EXPLORER SPORT TRAC 07-10	

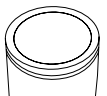

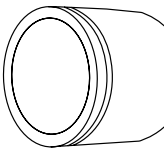



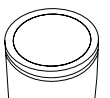

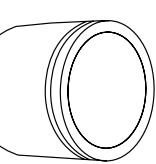



No. Lusac: 382542		No. Lusac: 382543		No. Lusac: 382544	
Producto: MANGUERA DE FRENOS		Producto: MANGUERA DE FRENOS		Producto: MANGUERA DE FRENOS	
DIAMETRO	21"	DIAMETRO	20.5"	DIAMETRO	10.62"
FORD EXPLORER EDDIE BAUER 06-14 EXPLORER SPORT TRAC 07-10		FORD EXPLORER EDDIE BAUER 06-14 EXPLORER SPORT TRAC 07-10		FORD MERCURY ESCAPE 07-12 MARINER 08-11	
No. Lusac: 382545		No. Lusac: 382546		No. Lusac: 382549	
Producto: MANGUERA DE FRENOS		Producto: MANGUERA DE FRENOS		Producto: MANGUERA DE FRENOS	
DIAMETRO	11.56"	DIAMETRO	21.19"	DIAMETRO	12.5"
FORD MERCURY ESCAPE 07-12 MARINER 08-11		FORD EXPEDITION 03-04		HONDA CIVIC 07-13	
No. Lusac: 382550		No. Lusac: 382551		No. Lusac: 382552	
Producto: MANGUERA DE FRENOS		Producto: MANGUERA DE FRENOS		Producto: MANGUERA DE FRENOS	
DIAMETRO	22.25"	DIAMETRO	14.56"	DIAMETRO	21.62"
HONDA CIVIC 07-13		HONDA CIVIC 07-11		HONDA CIVIC 07-11	









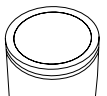

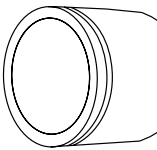



Fotografías de producto y especificaciones

No. Lusac: 382553		No. Lusac: 382554		No. Lusac: 382555	
Producto: MANGUERA DE FRENOS		Producto: MANGUERA DE FRENOS		Producto: MANGUERA DE FRENOS	
					
DIAMETRO	21.06"	DIAMETRO	20.5"	DIAMETRO	20.5"
HONDA		ACURA HONDA		ACURA HONDA	
CIVIC 07-11		TSX 09-14 ACCORD 08-12		TSX 09-14 ACCORD 08-12	
No. Lusac: 382556		No. Lusac: 382557		No. Lusac: 382558	
Producto: MANGUERA DE FRENOS		Producto: MANGUERA DE FRENOS		Producto: MANGUERA DE FRENOS	
					
DIAMETRO	20.38"	DIAMETRO	18.5"	DIAMETRO	8.62"
HONDA		HONDA		HONDA	
CR-V 05-06		ODYSSEY 05-10		ODYSSEY 05-10	
No. Lusac: 382559		No. Lusac: 382560		No. Lusac: 382564	
Producto: MANGUERA DE FRENOS		Producto: MANGUERA DE FRENOS		Producto: MANGUERA DE FRENOS	
					
DIAMETRO	22.31"	DIAMETRO	18.44"	DIAMETRO	18.88"
HONDA		HONDA		INFINITI	
CR-V 07-11		CR-V 07-11		QX56 04-06	
				NISSAN	
				ARMADA 04-10	
				TITAN 04-07	

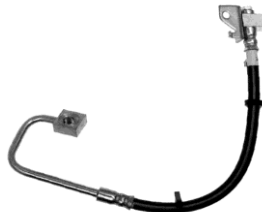





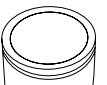

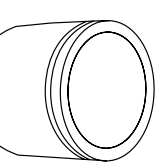



No. Lusac: 382565		No. Lusac: 382566		No. Lusac: 382567	
Producto: MANGUERA DE FRENOS		Producto: MANGUERA DE FRENOS		Producto: MANGUERA DE FRENOS	
					
DIAMETRO	18.88"	DIAMETRO	15"	DIAMETRO	15"
INFINITI QX56 04-06 NISSAN ARMADA 04-10		NISSAN ARMADA 04-13 TITAN 04-07		INFINITI QX56 04-10 NISSAN ARMADA 04-13 TITAN 04-07	
No. Lusac: 382570		No. Lusac: 382571		No. Lusac: 382572	
Producto: MANGUERA DE FRENOS		Producto: MANGUERA DE FRENOS		Producto: MANGUERA DE FRENOS	
					
DIAMETRO	20.5"	DIAMETRO	20.62"	DIAMETRO	19.12"
JEEP COMMANDER 06-10 GRAND CHEROKEE SRT8 06-10		JEEP COMMANDER 06-10 GRAND CHEROKEE SRT8 06-10		JEEP GRAND CHEROKEE SRT8 06-10	
No. Lusac: 382573		No. Lusac: 382574		No. Lusac: 382575	
Producto: MANGUERA DE FRENOS		Producto: MANGUERA DE FRENOS		Producto: MANGUERA DE FRENOS	
					
DIAMETRO	20.25"	DIAMETRO	15.62"	DIAMETRO	25.62"
JEEP GRAND CHEROKEE SRT8 06-10		LAND ROVER LR2 08-13		FORD FUSION SE 06-09 LINCOLN MKZ 07-08 10-10 09-09 ZEPHYR 06-06 MAZDA MAZDA6 03-08 MERCURY MILAN 06-09	





Fotografías de producto y especificaciones

No. Lusac: 382576 Producto: MANGUERA DE FRENOS 		No. Lusac: 382579 Producto: MANGUERA DE FRENOS 		No. Lusac: 382582 Producto: MANGUERA DE FRENOS 	
DIAMETRO	11.62"	DIAMETRO	18.88"	DIAMETRO	18.25"
FORD FUSION SE 06-09 LINCOLN MKZ 07-08 07-08 ZEPHYR 06		MAZDA MAZDA6 03-08 MERCURY MILAN 06-09		MAZDA CX-7 07-12 CX-9 07-14	
FORD ESCAPE 07-08		MERCURY MARINER 07-08			
No. Lusac: 382583 Producto: MANGUERA DE FRENOS 		No. Lusac: 382584 Producto: MANGUERA DE FRENOS 		No. Lusac: 382585 Producto: MANGUERA DE FRENOS 	
DIAMETRO	12.12"	DIAMETRO	15.16"	DIAMETRO	17"
MERCEDEZ BENZ C230 06-07 C350 06-07 C55 05-07 C55AMG 05-07 CLK320 98-05 CLK350 06-09		MERCEDEZ BENZ CLK500 03-06 CLK55AMG 01-06 CLK63AMG 08-09 SLK350 05-11 SLK55 AMG 05-10		MERCEDEZ BENZ CL500 07-09 CL600 07-13 E63 AMG 13-14 E63AMG 10-12	
MERCEDEZ BENZ S350L 11-13 S600L 07-13					
No. Lusac: 382586 Producto: MANGUERA DE FRENOS 		No. Lusac: 382587 Producto: MANGUERA DE FRENOS 		No. Lusac: 382588 Producto: MANGUERA DE FRENOS 	
DIAMETRO	17.12"	DIAMETRO	23.25"	DIAMETRO	11.81"
FORD E350 10-14		NISSAN QUEST 04-09		NISSAN QUEST 04-09	
MERCEDEZ BENZ C230 09 C300 08-14 C350 08-14 GLK350 09-14 SL500 03-06		MERCEDEZ BENZ SL55AMG 03-08 SL600 04-10 SL63AMG 09-12 SL65AMG 05-11 SPRINTER 311, 315, 415, 12			

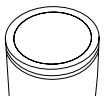

Fotografías de producto y especificaciones

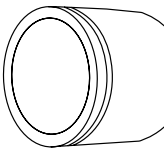



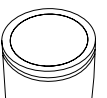

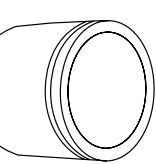



No. Lusac: 382589		No. Lusac: 382590		No. Lusac: 382591	
Producto: MANGUERA DE FRENOS		Producto: MANGUERA DE FRENOS		Producto: MANGUERA DE FRENOS	
DIAMETRO	11.81"	DIAMETRO	15.75"	DIAMETRO	13.5"
NISSAN QUEST 04-09		PONTIAC SOLSTICE 06-09		CHEVROLET UPLANDER 05-09	
PONTIAC MONTANA SV6 05-09		No. Lusac: 382592		No. Lusac: 382593	
Producto: MANGUERA DE FRENOS		Producto: MANGUERA DE FRENOS		Producto: MANGUERA DE FRENOS	
DIAMETRO	19.25"	DIAMETRO	20.19"	DIAMETRO	23.38"
TOYOTA CAMRY 07-11		TOYOTA CAMRY 07-11		TOYOTA CAMRY 07-11	
No. Lusac: 382595		No. Lusac: 382596		No. Lusac: 382597	
Producto: MANGUERA DE FRENOS		Producto: MANGUERA DE FRENOS		Producto: MANGUERA DE FRENOS	
DIAMETRO	19.25"	DIAMETRO	19.5"	DIAMETRO	29.06"
TOYOTA CAMRY 07-11		TOYOTA CAMRY 07-11		TOYOTA RAV4 06-13	





Fotografías de producto y especificaciones

No. Lusac: 382598 Producto: MANGUERA DE FRENOS 		No. Lusac: 382602 Producto: MANGUERA DE FRENOS 		No. Lusac: 382603 Producto: MANGUERA DE FRENOS 	
DIAMETRO	28.06"	DIAMETRO	16.5"	DIAMETRO	20.88"
TOYOTA RAV4 06-13		CHEVROLET GMC COLORADO 04-12 CANYON 07-12 SUBURBAN 2500 03-06		CHEVROLET GMC COLORADO 04-12 CANYON 07-12	
No. Lusac: 382605 Producto: MANGUERA DE FRENOS 		No. Lusac: 382606 Producto: MANGUERA DE FRENOS 		No. Lusac: 382607 Producto: MANGUERA DE FRENOS 	
DIAMETRO	20.88"	DIAMETRO	16.25"	DIAMETRO	14.5"
CHEVROLET GMC COLORADO 04-12 CANYON 07-12		CHEVROLET GMC COLORADO 04-12 CANYON 07-12		CADILLAC CTS V 03-06 STS 05-10 SRX 04-09	
No. Lusac: 382608 Producto: MANGUERA DE FRENOS 		No. Lusac: 382610 Producto: MANGUERA DE FRENOS 		No. Lusac: 382611 Producto: MANGUERA DE FRENOS 	
DIAMETRO	11.25"	DIAMETRO	11.56"	DIAMETRO	11.56"
HUMMER H2 SUT 05-07		CADILLAC ESCALADE 02-06 TAHOE 00-06 CHEVROLET SUBURBAN 1500 01-06		CADILLAC CHEVROLET ESCALADE 02-06 SUBURBAN 1500 01-06	

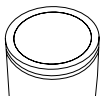

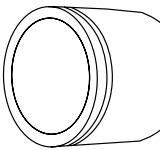

No. Lusac: 382612		No. Lusac: 382615		No. Lusac: 382616	
Producto: MANGUERA DE FRENOS		Producto: MANGUERA DE FRENOS		Producto: MANGUERA DE FRENOS	
DIAMETRO	13"	DIAMETRO	15.5" & 15"	DIAMETRO	24.88"
CHEVROLET SILVERADO 1500 03-05		CADILLAC ESCALADE 07-12 CHEVROLET AVALANCHE 07-13		GMC YUKON 07-14	
GMC SIERRA 1500 03-05				CHEVROLET TRAILBLAZER 02-07	
				OLDSMOBILE BRAVADA 02-04	
No. Lusac: 382617		No. Lusac: 382619		No. Lusac: 382620	
Producto: MANGUERA DE FRENOS		Producto: MANGUERA DE FRENOS		Producto: MANGUERA DE FRENOS	
DIAMETRO	24.88"	DIAMETRO	13.38"	DIAMETRO	17.25"
CHEVROLET TRAILBLAZER 02-07		CHEVROLET TRAILBLAZER 02-07		OLDSMOBILE BRAVADA 02-04	
				BMW Z4 03-09	
No. Lusac: 382621		No. Lusac: 382622		No. Lusac: 382623	
Producto: MANGUERA DE FRENOS		Producto: MANGUERA DE FRENOS		Producto: MANGUERA DE FRENOS	
DIAMETRO	9.19"	DIAMETRO	19"	DIAMETRO	12.95"
BMW Z4 03-09		MERCEDEZ BENZ SPRINTER 315 415 515 2500 3500 311 07-12		VOLVO S40 08-10	

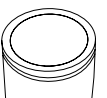

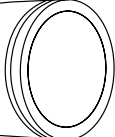







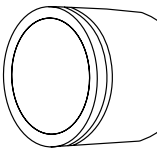



Fotografías de producto y especificaciones

No. Lusac: 382627		No. Lusac: 382628		No. Lusac: 382629	
Producto: MANGUERA DE FRENOS		Producto: MANGUERA DE FRENOS		Producto: MANGUERA DE FRENOS	
DIAMETRO	23.44"	DIAMETRO	18.88"	DIAMETRO	19.18"
NISSAN QUEST 99-02 SOLARA 07-08 TOYOTA CAMRY 07-11		CADILLAC CTS V 04-06		CADILLAC CTS V 04-06	
No. Lusac: 382630		No. Lusac: 382631		No. Lusac: 382632	
Producto: MANGUERA DE FRENOS		Producto: MANGUERA DE FRENOS		Producto: MANGUERA DE FRENOS	
DIAMETRO	30.25"	DIAMETRO	11.22"	DIAMETRO	18.5"
CHEVROLET PONTIAC VENTURE 02-04 MONTANA 02-05 OLDSMOBILE SILHOUETTE 02-04		CHEVROLET PONTIAC VENTURE 02-04 MONTANA 02-05 OLDSMOBILE SILHOUETTE 02-04		CADILLAC CHEVROLET XLR 04-06 CORVETTE 05-13	
No. Lusac: 382635		No. Lusac: 382636		No. Lusac: 382637	
Producto: MANGUERA DE FRENOS		Producto: MANGUERA DE FRENOS		Producto: MANGUERA DE FRENOS	
DIAMETRO	22.62"	DIAMETRO	22.62"	DIAMETRO	9.06"
NISSAN 370Z 09-14		INFINITI NISSAN M37 12-13 370Z 09-14		INFINITI NISSAN FX35 12 370Z 09-14 FX37 13 PICKUP NISSAN NP300 14 G37 12-13 QX70 14	





<p>No. Lusac: 382638</p> <p>Producto: MANGUERA DE FRENOS</p> 		<p>No. Lusac: 382643</p> <p>Producto: MANGUERA DE FRENOS</p> 		<p>No. Lusac: 382646</p> <p>Producto: MANGUERA DE FRENOS</p> 	
DIAMETRO	9.06"	DIAMETRO	13.5"	DIAMETRO	17.5"
<p>INFINITI</p> <p>FX35 12</p> <p>FX37 13</p> <p>G37 12-13</p>		<p>NISSAN</p> <p>370Z 09-14</p>		<p>TOYOTA</p> <p>RAV4 06-13</p>	
<p>NISSAN</p> <p>370Z 09-14</p>		<p>TOYOTA</p> <p>RAV4 06-13</p>		<p>NISSAN</p> <p>370Z 09-14</p>	
<p>No. Lusac: 382647</p> <p>Producto: MANGUERA DE FRENOS</p> 		<p>No. Lusac: 382648</p> <p>Producto: MANGUERA DE FRENOS</p> 		<p>No. Lusac: 382649</p> <p>Producto: MANGUERA DE FRENOS</p> 	
DIAMETRO	17.5"	DIAMETRO	12.44"	DIAMETRO	11.19"
<p>NISSAN</p> <p>370Z 09-14</p>		<p>TOYOTA</p> <p>RAV4 06-13</p>		<p>NISSAN</p> <p>370Z 09-14</p>	
<p>NISSAN</p> <p>370Z 09-14</p>		<p>TOYOTA</p> <p>RAV4 06-13</p>		<p>NISSAN</p> <p>370Z 09-14</p>	
<p>No. Lusac: 382650</p> <p>Producto: MANGUERA DE FRENOS</p> 		<p>No. Lusac: 382651</p> <p>Producto: MANGUERA DE FRENOS</p> 		<p>No. Lusac: 382656</p> <p>Producto: MANGUERA DE FRENOS</p> 	
DIAMETRO	11.19"	DIAMETRO	16.54"	DIAMETRO	18.12"
<p>NISSAN</p> <p>370Z 09-14</p>		<p>TOYOTA</p> <p>RAV4 06-13</p>		<p>NISSAN</p> <p>370Z 09-14</p>	
<p>NISSAN</p> <p>370Z 09-14</p>		<p>TOYOTA</p> <p>RAV4 06-13</p>		<p>NISSAN</p> <p>370Z 09-14</p>	

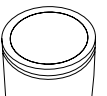

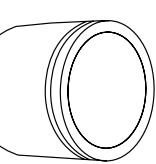





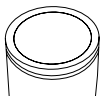

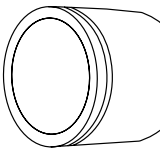



Fotografías de producto y especificaciones

No. Lusac: 382657		No. Lusac: 382658		No. Lusac: 382659	
Producto: MANGUERA DE FRENOS		Producto: MANGUERA DE FRENOS		Producto: MANGUERA DE FRENOS	
DIAMETRO	17.31"	DIAMETRO	23.12"	DIAMETRO	23"
CHEVROLET		NISSAN		NISSAN	
SILVERADO 1500 03-06		MURANO 04-08		MURANO 04-08	
No. Lusac: 382660		No. Lusac: 382663		No. Lusac: 382664	
Producto: MANGUERA DE FRENOS		Producto: MANGUERA DE FRENOS		Producto: MANGUERA DE FRENOS	
DIAMETRO	18.7"	DIAMETRO	17.5"	DIAMETRO	18.75"
JAGUAR		MAZDA		FORD	
X TYPE 02-08		MAZDA3 SPEED 06-14		FREESTAR 04-07	
No. Lusac: 382665		No. Lusac: 382669		No. Lusac: 382670	
Producto: MANGUERA DE FRENOS		Producto: MANGUERA DE FRENOS		Producto: MANGUERA DE FRENOS	
DIAMETRO	15.75"	DIAMETRO	23.25"	DIAMETRO	10"
FORD		MINI		LAND ROVER	
FREESTAR 04-07		COOPER S S 02-13		DISCOVERY 97-99	
No. Lusac: 382671		No. Lusac: 382674		No. Lusac: 382675	
Producto: MANGUERA DE FRENOS		Producto: MANGUERA DE FRENOS		Producto: MANGUERA DE FRENOS	
DIAMETRO	10"	DIAMETRO	16.75"	DIAMETRO	16.75"
LAND ROVER		NISSAN		NISSAN	
DISCOVERY 97-99		FRONTIER 02-04		FRONTIER 02-04	







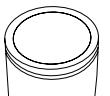

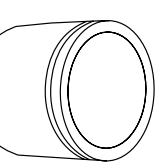

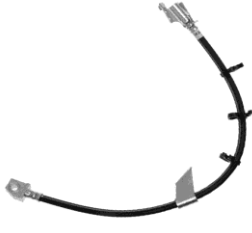

No. Lusac: 382676 Producto: MANGUERA DE FRENOS  Imagen Disponible Próximamente		No. Lusac: 382677 Producto: MANGUERA DE FRENOS 		No. Lusac: 382678 Producto: MANGUERA DE FRENOS 	
DIAMETRO	N/D	DIAMETRO	16"	DIAMETRO	15.25"
NISSAN FRONTIER 02-04		CHEVROLET COLORADO 04-12 GMC CANYON 07-08		CHEVROLET MALIBU 09-12 05-08 PONTIAC G6 05-09	
No. Lusac: 382679 Producto: MANGUERA DE FRENOS 		No. Lusac: 382680 Producto: MANGUERA DE FRENOS 		No. Lusac: 382681 Producto: MANGUERA DE FRENOS 	
DIAMETRO	15.25"	DIAMETRO	14.75"	DIAMETRO	15.25"
CHEVROLET MALIBU 05-12		CHEVROLET MALIBU 05-08		CHEVROLET MALIBU 05-08	
No. Lusac: 382682 Producto: MANGUERA DE FRENOS 		No. Lusac: 382683 Producto: MANGUERA DE FRENOS 		No. Lusac: 382684 Producto: MANGUERA DE FRENOS 	
DIAMETRO	32"	DIAMETRO	32"	DIAMETRO	24.5"
CHRYSLER ASPEN 07-09		DODGE DURANGO 04-09		CHRYSLER ASPEN 07-09	
DODGE DURANGO 04-09		CHRYSLER ASPEN 07-09		DODGE DURANGO 04-09	
FORD EXPEDITION 03-06		LINCOLN NAVIGATOR 03-06		FORD EXPEDITION 03-06	
LINCOLN NAVIGATOR 03-06		FORD EXPEDITION 03-06		LINCOLN NAVIGATOR 03-06	









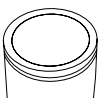



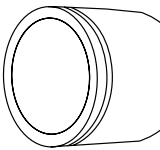

Fotografías de producto y especificaciones

No. Lusac: 382685 Producto: MANGUERA DE FRENOS 		No. Lusac: 382686 Producto: MANGUERA DE FRENOS 		No. Lusac: 382687 Producto: MANGUERA DE FRENOS 	
DIAMETRO	24.5"	DIAMETRO	21.75"	DIAMETRO	21.25"
FORD EXPEDITION 03-06		LINCOLN NAVIGATOR 03-06		FORD F350 05-07	
No. Lusac: 382688 Producto: MANGUERA DE FRENOS 		No. Lusac: 382689 Producto: MANGUERA DE FRENOS 		No. Lusac: 382690 Producto: MANGUERA DE FRENOS 	
DIAMETRO	23"	DIAMETRO	23"	DIAMETRO	21"
FORD F450 05-10 F550 05-07		FORD F450 05-10 F550 05-07		FORD F450 SUPER DUTY 05-07	
No. Lusac: 382691 Producto: MANGUERA DE FRENOS 		No. Lusac: 382692 Producto: MANGUERA DE FRENOS 		No. Lusac: 382693 Producto: MANGUERA DE FRENOS 	
DIAMETRO	15.5"	DIAMETRO	18"	DIAMETRO	18"
CHEVROLET TAHOE 03-06		CHEVROLET CORVETTE 05-13		GMC SIERRA 2500HD 12	
				CHEVROLET CORVETTE 05-13	



Fotografías de producto y especificaciones





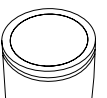

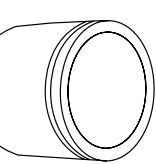



No. Lusac: 382694		No. Lusac: 382695		No. Lusac: 382696	
Producto: MANGUERA DE FRENOS		Producto: MANGUERA DE FRENOS		Producto: MANGUERA DE FRENOS	
					
DIAMETRO	30.12"	DIAMETRO	30.12"	DIAMETRO	16.19"
FORD E150 04-06		FORD E150 04-06		CHEVROLET SILVERADO 3500 05-06 GMC SIERRA 2500 04 SIERRA 2500HD CLASSIC 07-07 04-06	
No. Lusac: 382697		No. Lusac: 382700		No. Lusac: 382701	
Producto: MANGUERA DE FRENOS		Producto: MANGUERA DE FRENOS		Producto: MANGUERA DE FRENOS	
					
DIAMETRO	14.12"	DIAMETRO	18.81"	DIAMETRO	18.81"
FORD E150 CLUB WAGON ECONOLINE 04-07		CHEVROLET CAPTIVA SPORT 08-13 EQUINOX 07-08 PONTIAC TORRENT 06-09		SUZUKI XL7 07-09	
No. Lusac: 382702		No. Lusac: 382703		No. Lusac: 382704	
Producto: MANGUERA DE FRENOS		Producto: MANGUERA DE FRENOS		Producto: MANGUERA DE FRENOS	
					
DIAMETRO	13.25"	DIAMETRO	21.5"	DIAMETRO	21.5"
CHEVROLET TRAILBLAZER 02-07		FORD F350 08-10		FORD F350 08-10	





Fotografías de producto y especificaciones

No. Lusac: 382705 Producto: MANGUERA DE FRENOS 		No. Lusac: 382706 Producto: MANGUERA DE FRENOS 		No. Lusac: 382707 Producto: MANGUERA DE FRENOS 	
DIAMETRO	26"	DIAMETRO	26"	DIAMETRO	36.62"
FORD F350 08-12		FORD F350 08-12		FORD E150 10 E350 SUPER DUTY SUPER DUTY EXT 06-14	
No. Lusac: 382708 Producto: MANGUERA DE FRENOS 		No. Lusac: 382709 Producto: MANGUERA DE FRENOS 		No. Lusac: 382710 Producto: MANGUERA DE FRENOS 	
DIAMETRO	12"	DIAMETRO	29"	DIAMETRO	29"
FORD E150 ECONOLINE VAN 08-14 E250 ECONOLINE VAN 08-14		FORD F550 08-10		FORD F550 08-10	
No. Lusac: 382714 Producto: MANGUERA DE FRENOS 		No. Lusac: 382715 Producto: MANGUERA DE FRENOS 		No. Lusac: 382716 Producto: MANGUERA DE FRENOS 	
DIAMETRO	19.12"	DIAMETRO	20"	DIAMETRO	17"
TOYOTA TACOMA 06-11		TOYOTA TACOMA 06-11		TOYOTA TACOMA 06-11	

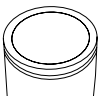

Fotografías de producto y especificaciones

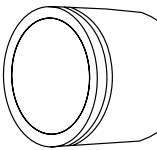



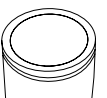

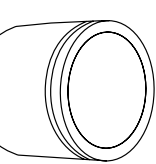



No. Lusac: 382717		No. Lusac: 382720		No. Lusac: 382721	
Producto: MANGUERA DE FRENOS		Producto: MANGUERA DE FRENOS		Producto: MANGUERA DE FRENOS	
DIAMETRO	17"	DIAMETRO	19.75"	DIAMETRO	19.75"
TOYOTA		ACURA HONDA		ACURA HONDA	
TACOMA 06-11		TSX 09-13 ACCORD 08-12		TSX 09-13 ACCORD 08-12	
No. Lusac: 382725		No. Lusac: 382726		No. Lusac: 382727	
Producto: MANGUERA DE FRENOS		Producto: MANGUERA DE FRENOS		Producto: MANGUERA DE FRENOS	
DIAMETRO	10.44"	DIAMETRO	12.06"	DIAMETRO	11.62"
FORD		FORD		FORD LINCOLN	
F150 99-04		F150 02-03		F150 XL 04-10 MARK LT 06-07 LOBO 04-10	
No. Lusac: 382728		No. Lusac: 382729		No. Lusac: 382736	
Producto: MANGUERA DE FRENOS		Producto: MANGUERA DE FRENOS		Producto: MANGUERA DE FRENOS	
DIAMETRO	11.62"	DIAMETRO	12.19"	DIAMETRO	20.5"
FORD LINCOLN		CADILLAC		FORD LINCOLN	
F150 XL 04-10 MARK LT 06-07 LOBO 04-10		CTS 03-07		F150 XL 05-09 MARK LT 06-08 LOBO 05-09	









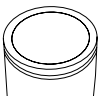



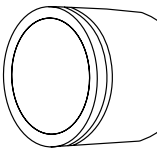

Fotografías de producto y especificaciones

No. Lusac: 382737 Producto: MANGUERA DE FRENOS 		No. Lusac: 382742 Producto: MANGUERA DE FRENOS 		No. Lusac: 382743 Producto: MANGUERA DE FRENOS 	
DIAMETRO	20.5"	DIAMETRO	19"	DIAMETRO	19"
FORD F150 XL 05-09 LOBO 05-09		LINCOLN MARK LT 06-08		CHEVROLET EQUINOX 05-06	
No. Lusac: 382744 Producto: MANGUERA DE FRENOS 		No. Lusac: 382745 Producto: MANGUERA DE FRENOS 		No. Lusac: 382748 Producto: MANGUERA DE FRENOS 	
DIAMETRO	20.5"	DIAMETRO	20.5"	DIAMETRO	10.75"
CHEVROLET CAPTIVA SPORT 08-13		CHEVROLET CAPTIVA SPORT 08-13		HONDA CR-V 02-06	
No. Lusac: 382752 Producto: MANGUERA DE FRENOS 		No. Lusac: 382753 Producto: MANGUERA DE FRENOS 		No. Lusac: 382754 Producto: MANGUERA DE FRENOS 	
DIAMETRO	20.5"	DIAMETRO	24"	DIAMETRO	8.30"
DODGE RAM 1500 02-06		CHRYSLER PACIFICA TOURING 04-08		DODGE RAM 1500 07-08	



Fotografías de producto y especificaciones



No. Lusac: 382757		No. Lusac: 382758		No. Lusac: 382762	
Producto: MANGUERA DE FRENOS		Producto: MANGUERA DE FRENOS		Producto: MANGUERA DE FRENOS	
					
DIAMETRO	26.25"	DIAMETRO	13"	DIAMETRO	38"
FORD FUSION SE 06-09 LINCOLN MKZ 07-10 ZEPHYR 06		MAZDA MAZDA6 06-08 MERCURY MILAN 07-08		CHEVROLET UPLANDER 05-09 PONTIAC MONTANA SV6 05-09 DODGE DAKOTA 03-04	
No. Lusac: 382764		No. Lusac: 382765		No. Lusac: 382768	
Producto: MANGUERA DE FRENOS		Producto: MANGUERA DE FRENOS		Producto: MANGUERA DE FRENOS	
					
DIAMETRO	10"	DIAMETRO	9.81"	DIAMETRO	12.75" & 7.25"
JEEP LIBERTY 02-08		JEEP LIBERTY 02-07		HONDA RIDGELINE 07-14 07-14	
No. Lusac: 382769		No. Lusac: 382771		No. Lusac: 382773	
Producto: MANGUERA DE FRENOS		Producto: MANGUERA DE FRENOS		Producto: MANGUERA DE FRENOS	
					
DIAMETRO	16.69"	DIAMETRO	10.25"	DIAMETRO	17.31"
BUICK VERANO 13-13 CHEVROLET CRUZE 11-14		FORD F550 11-12		FORD ESCAPE 09-12 MERCURY MARINER 08-11	

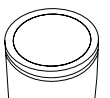

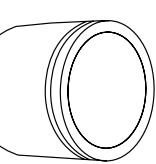





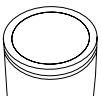

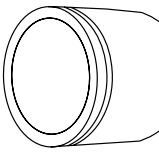



Fotografías de producto y especificaciones

No. Lusac: 382775 Producto: MANGUERA DE FRENOS		No. Lusac: 382776 Producto: MANGUERA DE FRENOS		No. Lusac: 382779 Producto: MANGUERA DE FRENOS	
DIAMETRO	13"	DIAMETRO	13"	DIAMETRO	19"
ACURA RL 07-11		ACURA RL 07-11		FORD FREESTAR 04-05	
No. Lusac: 382780 Producto: MANGUERA DE FRENOS		No. Lusac: 382785 Producto: MANGUERA DE FRENOS		No. Lusac: 382786 Producto: MANGUERA DE FRENOS	
DIAMETRO	19"	DIAMETRO	29.85"	DIAMETRO	11.12"
FORD FREESTAR 04-05		FORD F450 99-04		FORD F450 99-04	
No. Lusac: 382787 Producto: MANGUERA DE FRENOS		No. Lusac: 382788 Producto: MANGUERA DE FRENOS		No. Lusac: 382789 Producto: MANGUERA DE FRENOS	
DIAMETRO	22.12"	DIAMETRO	10"	DIAMETRO	28.75"
FORD F450 03-04		FORD F450 03-04		FORD F550 01-04	







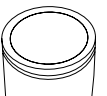

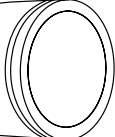



<p>No. Lusac: 382790</p> <p>Producto: MANGUERA DE FRENOS</p> 		<p>No. Lusac: 382793</p> <p>Producto: MANGUERA DE FRENOS</p> 		<p>No. Lusac: 382794</p> <p>Producto: MANGUERA DE FRENOS</p> 	
DIAMETRO	20.5"	DIAMETRO	30"	DIAMETRO	29.88"
<p>FORD</p> <p>F550 01-04</p>		<p>CHEVROLET</p> <p>EXPRESS 1500 CARGO VAN 11-13</p> <p>EXPRESS 2500 CARGO VAN 04-06</p>		<p>CHEVROLET</p> <p>EXPRESS 1500 CARGO VAN 11-13</p> <p>EXPRESS 2500 CARGO VAN 04-06</p>	
<p>No. Lusac: 382795</p> <p>Producto: MANGUERA DE FRENOS</p> 		<p>No. Lusac: 382841</p> <p>Producto: MANGUERA DE FRENOS</p> 		<p>No. Lusac: 382844</p> <p>Producto: MANGUERA DE FRENOS</p> 	
DIAMETRO	21.62"	DIAMETRO	19"	DIAMETRO	20.5"
<p>CHEVROLET</p> <p>EXPRESS 1500 CARGO VAN 03-13</p> <p>EXPRESS 2500 CARGO VAN 04-13</p> <p>EXPRESS 3500 VAN 03-11</p>		<p>MAZDA</p> <p>MAZDA3 SPEED 06-14</p>		<p>LINCOLN</p> <p>MKX 07-10</p>	
<p>No. Lusac: 382845</p> <p>Producto: MANGUERA DE FRENOS</p> 		<p>No. Lusac: 382846</p> <p>Producto: MANGUERA DE FRENOS</p> 		<p>No. Lusac: 382847</p> <p>Producto: MANGUERA DE FRENOS</p> 	
DIAMETRO	20.5"	DIAMETRO	N/D	DIAMETRO	N/D
<p>MITSUBISHI</p> <p>ECLIPSE GT 06-12</p> <p>GALANT ES GTS INC ES, RALLIART 03-09</p>		<p>MITSUBISHI</p> <p>ECLIPSE GT 06-12</p> <p>GALANT ES GTS INC ES, RALLIART 03-09</p>		<p>MITSUBISHI</p> <p>ENDEAVOR LIMITED LIMITED 04-08 11</p>	









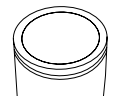

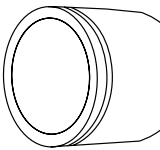



Fotografías de producto y especificaciones

No. Lusac: 382848 Producto: MANGUERA DE FRENOS 		No. Lusac: 382849 Producto: MANGUERA DE FRENOS  Imagen Disponible Próximamente		No. Lusac: 382850 Producto: MANGUERA DE FRENOS  Imagen Disponible Próximamente	
DIAMETRO	10.75"	DIAMETRO	N/D	DIAMETRO	37.88"
mitsubishi ENDEAVOR LIMITED 04-08 11		CHRYSLER STRATUS 03-06		mitsubishi ENDEAVOR LIMITED 04-08 11	
No. Lusac: 382852 Producto: MANGUERA DE FRENOS  Imagen Disponible Próximamente		No. Lusac: 382853 Producto: MANGUERA DE FRENOS  Imagen Disponible Próximamente		No. Lusac: 382854 Producto: MANGUERA DE FRENOS  Imagen Disponible Próximamente	
DIAMETRO	22.5"	DIAMETRO	24"	DIAMETRO	8.30"
lincoln MKS 09-14		NISSAN MURANO 04-08		NISSAN MURANO 04-08	
No. Lusac: 382855 Producto: MANGUERA DE FRENOS  Imagen Disponible Próximamente		No. Lusac: 382856 Producto: MANGUERA DE FRENOS  Imagen Disponible Próximamente		No. Lusac: 382857 Producto: MANGUERA DE FRENOS  Imagen Disponible Próximamente	
DIAMETRO	N/D	DIAMETRO	N/D	DIAMETRO	26.55"
NISSAN FRONTIER 05-13 XTERRA 05-07 PATHFINDER 05-12		NISSAN FRONTIER 05-13 XTERRA 05-07 PATHFINDER 05-12		NISSAN PATHFINDER 05-12	







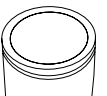

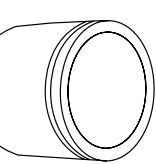



No. Lusac: 382858		No. Lusac: 382859		No. Lusac: 382860	
Producto: MANGUERA DE FRENOS		Producto: MANGUERA DE FRENOS		Producto: MANGUERA DE FRENOS	
					
Imagen Disponible Próximamente		Imagen Disponible Próximamente		Imagen Disponible Próximamente	
DIAMETRO	13"	DIAMETRO	12.5"	DIAMETRO	19.12"
NISSAN PATHFINDER 05-12		NISSAN FRONTIER 05-13		NISSAN FRONTIER 05-13	
No. Lusac: 382861		No. Lusac: 382862		No. Lusac: 382869	
Producto: MANGUERA DE FRENOS		Producto: MANGUERA DE FRENOS		Producto: MANGUERA DE FRENOS	
					
Imagen Disponible Próximamente		Imagen Disponible Próximamente			
DIAMETRO	17.18"	DIAMETRO	38"	DIAMETRO	16.69"
NISSAN TIIDA 10-12		NISSAN TIIDA 10-12		NISSAN TIIDA 07-12	
No. Lusac: 382870		No. Lusac: 382877		No. Lusac: 382878	
Producto: MANGUERA DE FRENOS		Producto: MANGUERA DE FRENOS		Producto: MANGUERA DE FRENOS	
					
Imagen Disponible Próximamente					
DIAMETRO	8.6"	DIAMETRO	11.38"	DIAMETRO	11.38"
NISSAN TIIDA 07-12		TOYOTA 4RUNNER 03-09 FJ CRUISER PREMIUM 08-13		TOYOTA 4RUNNER 03-09 FJ CRUISER PREMIUM 08-13	









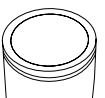

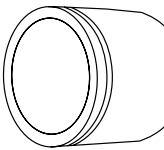



Fotografías de producto y especificaciones

No. Lusac: 382881		No. Lusac: 382882		No. Lusac: 382883	
Producto: MANGUERA DE FRENOS		Producto: MANGUERA DE FRENOS		Producto: MANGUERA DE FRENOS	
					
DIAMETRO	21.62"	DIAMETRO	21.62"	DIAMETRO	20"
TOYOTA		TOYOTA		TOYOTA	
TACOMA 06-11		TACOMA 06-11		HIGHLANDER 08-13	
No. Lusac: 382884		No. Lusac: 382886		No. Lusac: 382888	
Producto: MANGUERA DE FRENOS		Producto: MANGUERA DE FRENOS		Producto: MANGUERA DE FRENOS	
					
DIAMETRO	20"	DIAMETRO	22.09"	DIAMETRO	8.62"
TOYOTA		AUDI		VOLKSWAGEN	
HIGHLANDER 08-13		A3 04-12		PASSAT 03-04 06-11	
No. Lusac: 382889		No. Lusac: 382890		No. Lusac: 382903	
Producto: MANGUERA DE FRENOS		Producto: MANGUERA DE FRENOS		Producto: MANGUERA DE FRENOS	
					
DIAMETRO	9.88"	DIAMETRO	9.65"	DIAMETRO	12.5"
FORD		FORD		CADILLAC	
F350 05-10		F350 05-10		SRX 04-09 STS 05-10	







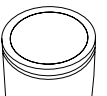

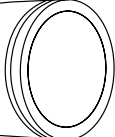



No. Lusac: 382905 Producto: MANGUERA DE FRENOS		No. Lusac: 382906 Producto: MANGUERA DE FRENOS		No. Lusac: 382907 Producto: MANGUERA DE FRENOS	
					
DIAMETRO	30"	DIAMETRO	30"	DIAMETRO	17.12"
CADILLAC SRX 04-09		CADILLAC SRX 04-09		ACURA MDX 05-06	
No. Lusac: 382912 Producto: MANGUERA DE FRENOS		No. Lusac: 382913 Producto: MANGUERA DE FRENOS		No. Lusac: 382916 Producto: MANGUERA DE FRENOS	
					
DIAMETRO	22"	DIAMETRO	22"	DIAMETRO	19"
CADILLAC CTS 08-14		CADILLAC CTS 08-12		CHEVROLET CRUZE 10-14	
No. Lusac: 382917 Producto: MANGUERA DE FRENOS		No. Lusac: 382918 Producto: MANGUERA DE FRENOS		No. Lusac: 382919 Producto: MANGUERA DE FRENOS	
					
DIAMETRO	19"	DIAMETRO	20.5"	DIAMETRO	19.75"
CHEVROLET CRUZE 10-14		JEEP WRANGLER 07-12		JEEP WRANGLER 07-12	





Fotografías de producto y especificaciones

No. Lusac: 382920		No. Lusac: 382921		No. Lusac: 382922	
Producto: MANGUERA DE FRENOS		Producto: MANGUERA DE FRENOS		Producto: MANGUERA DE FRENOS	
					
DIAMETRO	22.5"	DIAMETRO	22.5"	DIAMETRO	18.75"
JEEP		JEEP		FORD LINCOLN	
WRANGLER 07-10		WRANGLER 07-10		EXPEDITION 07-14 NAVIGATOR 07-14	
No. Lusac: 382923		No. Lusac: 382924		No. Lusac: 382925	
Producto: MANGUERA DE FRENOS		Producto: MANGUERA DE FRENOS		Producto: MANGUERA DE FRENOS	
					
DIAMETRO	18.75"	DIAMETRO	18.75"	DIAMETRO	18.75"
FORD LINCOLN		FORD LINCOLN		FORD LINCOLN	
EXPEDITION 07-14 NAVIGATOR 07-14		EXPEDITION 07-14 NAVIGATOR 07-14		EXPEDITION 07-14 NAVIGATOR 07-14	
No. Lusac: 382926		No. Lusac: 382927		No. Lusac: 382932	
Producto: MANGUERA DE FRENOS		Producto: MANGUERA DE FRENOS		Producto: MANGUERA DE FRENOS	
					
DIAMETRO	18.75"	DIAMETRO	18.75"	DIAMETRO	18.25"
FORD LINCOLN		FORD LINCOLN		MERCEDEZ BENZ	
EDGE 07-14 MKX 11-14		EDGE 07-14 MKX 11-14		SPRINTER 515 12	

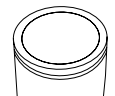

Fotografías de producto y especificaciones

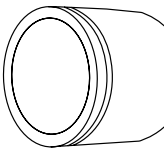



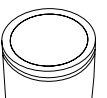

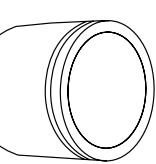



No. Lusac: 382934		No. Lusac: 382935		No. Lusac: 382939	
Producto: MANGUERA DE FRENOS		Producto: MANGUERA DE FRENOS		Producto: MANGUERA DE FRENOS	
DIAMETRO	15.38"	DIAMETRO	15.38"	DIAMETRO	12"
FORD		FORD		FORD	
FIESTA 11-14		FIESTA 11-14		F150 XL 09-14 LOBO 09-14	
No. Lusac: 382940		No. Lusac: 382941		No. Lusac: 382942	
Producto: MANGUERA DE FRENOS		Producto: MANGUERA DE FRENOS		Producto: MANGUERA DE FRENOS	
DIAMETRO	12.19"	DIAMETRO	14.25"	DIAMETRO	14.25"
FORD		FORD		FORD	
F150 XL 09-14 LOBO 09-14		F150 XL 10-14 LOBO 10-14		F150 XL 10-14 LOBO 10-14	
No. Lusac: 382943		No. Lusac: 382948		No. Lusac: 382949	
Producto: MANGUERA DE FRENOS		Producto: MANGUERA DE FRENOS		Producto: MANGUERA DE FRENOS	
DIAMETRO	9.75"	DIAMETRO	17"	DIAMETRO	17"
FORD		FORD LINCOLN		FORD LINCOLN	
RANGER 10-11		FUSION 10-12 MKZ 09-12		FUSION 10-12 MKZ 09-12	









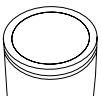

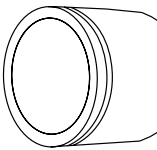

Fotografías de producto y especificaciones

No. Lusac: 382950 Producto: MANGUERA DE FRENOS 		No. Lusac: 382953 Producto: MANGUERA DE FRENOS 		No. Lusac: 382954 Producto: MANGUERA DE FRENOS 	
DIAMETRO	19" & 21.5"	DIAMETRO	21"	DIAMETRO	21"
FORD RANGER 10-11		LINCOLN MKS 09-10		LINCOLN MKS 09-10	
No. Lusac: 382961 Producto: MANGUERA DE FRENOS 		No. Lusac: 382964 Producto: MANGUERA DE FRENOS 		No. Lusac: 382965 Producto: MANGUERA DE FRENOS 	
DIAMETRO	15.75"	DIAMETRO	12.5"	DIAMETRO	12.38"
CADILLAC XLR 04-06		CHEVROLET CORVETTE 05-13		NISSAN ALTIMA 02-07 MAXIMA SE 07-08	
No. Lusac: 382966 Producto: MANGUERA DE FRENOS 		No. Lusac: 382967 Producto: MANGUERA DE FRENOS 		No. Lusac: 382971 Producto: MANGUERA DE FRENOS 	
DIAMETRO	8.75"	DIAMETRO	8.75"	DIAMETRO	26.25"
NISSAN JUKE 12-14		NISSAN JUKE 12-14		NISSAN JUKE 12-14	



Fotografías de producto y especificaciones

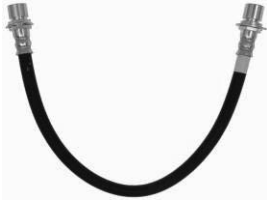



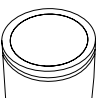

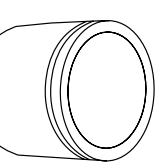



No. Lusac: 382972 Producto: MANGUERA DE FRENOS		No. Lusac: 382983 Producto: MANGUERA DE FRENOS		No. Lusac: 382984 Producto: MANGUERA DE FRENOS	
					
DIAMETRO	24.75"	DIAMETRO	17.52"	DIAMETRO	17.5"
NISSAN JUKE 12-14		MINI COOPER S S 02-03		MINI COOPER S 03-08	
No. Lusac: 382995 Producto: MANGUERA DE FRENOS		No. Lusac: 382996 Producto: MANGUERA DE FRENOS		No. Lusac: 382998 Producto: MANGUERA DE FRENOS	
					
DIAMETRO	9.57"	DIAMETRO	39"	DIAMETRO	18.38"
FORD F150 XL 09-12 LOBO 09-12		FORD F150 XL 09-12 LOBO 09-12		CADILLAC XLR 04-06	
No. Lusac: 382999 Producto: MANGUERA DE FRENOS		No. Lusac: 383001 Producto: MANGUERA DE FRENOS		No. Lusac: 383002 Producto: MANGUERA DE FRENOS	
					
DIAMETRO	N/D	DIAMETRO	17.18"	DIAMETRO	15.55"
GMC CANYON 07-10		CHEVROLET SILVERADO 1500 14-14		CHEVROLET SILVERADO 1500 14-14	









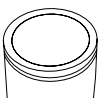



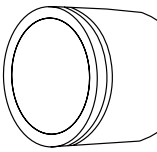

Fotografías de producto y especificaciones

No. Lusac: 383003 Producto: MANGUERA DE FRENOS 		No. Lusac: 383005 Producto: MANGUERA DE FRENOS 		No. Lusac: 383006 Producto: MANGUERA DE FRENOS 	
DIAMETRO	13"	DIAMETRO	21.69"	DIAMETRO	21.25"
CADILLAC ESCALADE ESV 07-14 TAHOE 07-14		CHEVROLET EXPRESS 2500 CARGO VAN 07-08 EXPRESS 3500 VAN 03-13		CADILLAC ESCALADE ESV 07-14 TAHOE 07-14	
CHEVROLET GMC AVALANCHE 07-13 YUKON 07-14 SUBURBAN 1500 07-13				CHEVROLET GMC AVALANCHE 07-13 YUKON 07-14 SILVERADO 1500 14 SUBURBAN 1500 07-13	
No. Lusac: 383007 Producto: MANGUERA DE FRENOS 		No. Lusac: 383012 Producto: MANGUERA DE FRENOS 		No. Lusac: 383018 Producto: MANGUERA DE FRENOS 	
DIAMETRO	21.25"	DIAMETRO	19.18"	DIAMETRO	13.7"
CADILLAC ESCALADE ESV 07-14 TAHOE 07-14		CHEVROLET SILVERADO 1500 14		JEEP LIBERTY 07	
CHEVROLET GMC AVALANCHE 07-13 YUKON 07-14 SILVERADO 1500 14-14 SUBURBAN 1500 07-13					
No. Lusac: 383021 Producto: MANGUERA DE FRENOS 		No. Lusac: 383023 Producto: MANGUERA DE FRENOS 		No. Lusac: 383024 Producto: MANGUERA DE FRENOS 	
DIAMETRO	11.34"	DIAMETRO	20.28"	DIAMETRO	20.28"
FORD F550 05-10		NISSAN ALTIMA 08-14		NISSAN ALTIMA 08-14	



Fotografías de producto y especificaciones





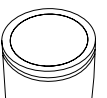

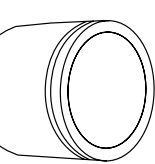



No. Lusac: 383025		No. Lusac: 383026		No. Lusac: 383029	
Producto: MANGUERA DE FRENOS		Producto: MANGUERA DE FRENOS		Producto: MANGUERA DE FRENOS	
					
DIAMETRO	23.94"	DIAMETRO	23.94"	DIAMETRO	19.37"
NISSAN		NISSAN		TOYOTA	
SENTRA SE-R 07-12		SENTRA SE-R 07-12		HIGHLANDER 08-13	
No. Lusac: 383030		No. Lusac: 383031		No. Lusac: 383032	
Producto: MANGUERA DE FRENOS		Producto: MANGUERA DE FRENOS		Producto: MANGUERA DE FRENOS	
					
DIAMETRO	19.37"	DIAMETRO	13.66"	DIAMETRO	10.39"
TOYOTA		TOYOTA		TOYOTA	
HIGHLANDER 08-13		TUNDRA 07-13		TUNDRA 07-13	
No. Lusac: 383033		No. Lusac: 383037		No. Lusac: 383038	
Producto: MANGUERA DE FRENOS		Producto: MANGUERA DE FRENOS		Producto: MANGUERA DE FRENOS	
					
DIAMETRO	N/D	DIAMETRO	32.88"	DIAMETRO	32.88"
TOYOTA		CHEVROLET		CHEVROLET	
COROLLA S 09-14		EXPRESS 2500 CARGO VAN 04-13		EXPRESS 2500 CARGO VAN 04-13	
MATRIX XR 09-10		EXPRESS CUTAWAY 11-12		EXPRESS CUTAWAY 11-12	
		EXPRESS 3500 VAN 03-11		EXPRESS 3500 VAN 07-13	









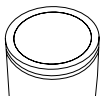

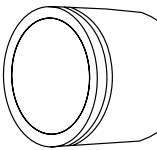



Fotografías de producto y especificaciones

No. Lusac: 383039 Producto: MANGUERA DE FRENOS 		No. Lusac: 383040 Producto: MANGUERA DE FRENOS 		No. Lusac: 383041 Producto: MANGUERA DE FRENOS 	
DIAMETRO	15.75"	DIAMETRO	15.75"	DIAMETRO	23.38"
CHEVROLET UPLANDER 05-09		PONTIAC MONTANA SV6 05-09		CHEVROLET UPLANDER 05-09	
				PONTIAC MONTANA SV6 05-09 05-05	
				CADILLAC STS 05-10	
No. Lusac: 383042 Producto: MANGUERA DE FRENOS 		No. Lusac: 383045 Producto: MANGUERA DE FRENOS 		No. Lusac: 383047 Producto: MANGUERA DE FRENOS 	
DIAMETRO	28.75"	DIAMETRO	21.5"	DIAMETRO	20.19"
CADILLAC STS 05-10		CHEVROLET EXPRESS 1500 CARGO VAN 03-13 EXPRESS 2500 CARGO VAN 04-13		TOYOTA SIENNA 04-10	
No. Lusac: 383050 Producto: MANGUERA DE FRENOS 		No. Lusac: 383051 Producto: MANGUERA DE FRENOS 		No. Lusac: 383073 Producto: MANGUERA DE FRENOS 	
DIAMETRO	15.25"	DIAMETRO	17"	DIAMETRO	16.75"
JEEP COMMANDER 06-10		JEEP COMMANDER 06-10		AUDI Q7 10-13	
				VOLKSWAGEN TIGUAN 09-14 09-14	
				PORSCHE CAYENNE 03-05	
				TOUAREG 04-14	





No. Lusac: 383074		No. Lusac: 383075		No. Lusac: 383076	
Producto: MANGUERA DE FRENOS		Producto: MANGUERA DE FRENOS		Producto: MANGUERA DE FRENOS	
					
DIAMETRO	24"	DIAMETRO	19.76"	DIAMETRO	6.5"
VOLKSWAGEN PASSAT 06-11		BMW 323IA 98-01 330I 01-03 05-07 325I 01-06 M3 01-06 328I 99-00 330CI 01-06		BMW X5 00-06	
No. Lusac: 383077		No. Lusac: 383078		No. Lusac: 383079	
Producto: MANGUERA DE FRENOS		Producto: MANGUERA DE FRENOS		Producto: MANGUERA DE FRENOS	
					
DIAMETRO	6.5"	DIAMETRO	24.76"	DIAMETRO	20.04"
BMW X5 00-06		BMW X5 07-14 X6 09-14		BMW X5 00-06	
No. Lusac: 383087		No. Lusac: 383088		No. Lusac: 383094	
Producto: MANGUERA DE FRENOS		Producto: MANGUERA DE FRENOS		Producto: MANGUERA DE FRENOS	
					
DIAMETRO	N/D	DIAMETRO	14.8"	DIAMETRO	12.13"
DODGE RAM 2500 11-12		TOYOTA MATRIX XR 09-10		FORD LINCOLN FUSION 10-12 MKZ 09-12	

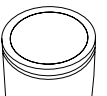

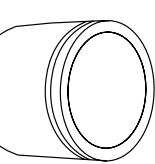





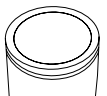

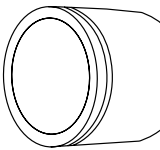



Fotografías de producto y especificaciones

No. Lusac: 383095		No. Lusac: 383098		No. Lusac: 383099	
Producto: MANGUERA DE FRENOS		Producto: MANGUERA DE FRENOS		Producto: MANGUERA DE FRENOS	
DIAMETRO	12.13"	DIAMETRO	14.57"	DIAMETRO	14.57"
FORD FUSION 10-12		LINCOLN MKZ 09-12		BUICK ENCLAVE 10-14 CHEVROLET TRAVERSE 09-14	
GMC ACADIA 07-14		BUICK ENCLAVE 10-14 CHEVROLET TRAVERSE 09-14		GMC ACADIA 07-14	
No. Lusac: 383100		No. Lusac: 383101		No. Lusac: 383104	
Producto: MANGUERA DE FRENOS		Producto: MANGUERA DE FRENOS		Producto: MANGUERA DE FRENOS	
DIAMETRO	15.55"	DIAMETRO	15.55"	DIAMETRO	14.17"
CHEVROLET CORVETTE 05-13		CHEVROLET CORVETTE 05-13		BUICK ENCLAVE 10-14 CHEVROLET TRAVERSE 09-14	
GMC ACADIA 07-14					
No. Lusac: 383105		No. Lusac: 383106		No. Lusac: 383110	
Producto: MANGUERA DE FRENOS		Producto: MANGUERA DE FRENOS		Producto: MANGUERA DE FRENOS	
DIAMETRO	14.17"	DIAMETRO	18.58"	DIAMETRO	22.48"
BUICK ENCLAVE 10-14 CHEVROLET TRAVERSE 09-14		GMC ACADIA 07-14		CHEVROLET SILVERADO 1500 14	
				HONDA CIVIC EX 06-10	







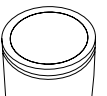

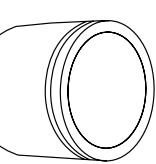



No. Lusac: 383111 Producto: MANGUERA DE FRENOS 		No. Lusac: 383112 Producto: MANGUERA DE FRENOS 		No. Lusac: 383127 Producto: MANGUERA DE FRENOS 	
DIAMETRO	22.48"	DIAMETRO	19.17"	DIAMETRO	11.18"
HONDA CIVIC EX 06-10		ACURA MDX 07-13 ZDX 10-11		HONDA PILOT 09-14	
				FORD E350 07-09 MERCEDEZ BENZ CLS63 08-11 E500 03-06	
				E55AMG 99-06 E63AMG 07-09 S430 00-05	
No. Lusac: 383128 Producto: MANGUERA DE FRENOS 		No. Lusac: 383129 Producto: MANGUERA DE FRENOS 		No. Lusac: 383130 Producto: MANGUERA DE FRENOS 	
DIAMETRO	20.51"	DIAMETRO	14.92"	DIAMETRO	16.06"
MERCEDEZ BENZ S430 00-05		MERCEDEZ BENZ CL63 AMG 13 CL63AMG 09-13 CL65 AMG 13 CL65AMG 09-12 S350L 11-13 S600L 07-13		MERCEDEZ BENZ S63 AMG 13 S63AMG 08-12 S65L AMG 13 S65LAMG 08-12	
				MERCEDEZ BENZ SL500 03-06 SL600 04-10 SL63AMG 09-12	
				SL65AMG 06-11	
No. Lusac: 383131 Producto: MANGUERA DE FRENOS 		No. Lusac: 383132 Producto: MANGUERA DE FRENOS 		No. Lusac: 383133 Producto: MANGUERA DE FRENOS 	
DIAMETRO	22.99"	DIAMETRO	19.09"	DIAMETRO	15.98"
MERCEDEZ BENZ ML350 09-12 ML63 AMG 07-11 R350L 07-13		MERCEDEZ BENZ G500 06-08 G63 AMG 13-14		FORD E350 07-09 MERCEDEZ BENZ CLS63 08-11 E320 03-05	
R500L 06-08				E500 03-06 E55AMG 99-06 E63AMG 07-09	









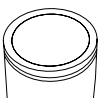

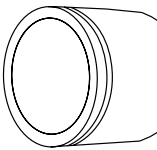



Fotografías de producto y especificaciones

No. Lusac: 383135 Producto: MANGUERA DE FRENOS 		No. Lusac: 383136 Producto: MANGUERA DE FRENOS 		No. Lusac: 383137 Producto: MANGUERA DE FRENOS 	
DIAMETRO	22.28"	DIAMETRO	22.24"	DIAMETRO	20.43"
FORD MONDEO SPORT XLS 03-04		MITSUBISHI LANCER RALLIART 04-06		MITSUBISHI LANCER DE, ES 08-14	
No. Lusac: 383138 Producto: MANGUERA DE FRENOS 		No. Lusac: 383143 Producto: MANGUERA DE FRENOS 		No. Lusac: 383145 Producto: MANGUERA DE FRENOS 	
DIAMETRO	20.43"	DIAMETRO	14.49" & 6.73"	DIAMETRO	9.96"
MITSUBISHI LANCER DE, ES 08-14		INFINITI Q45 03-06		NISSAN ROGUE 08-14	
No. Lusac: 383146 Producto: MANGUERA DE FRENOS 		No. Lusac: 383147 Producto: MANGUERA DE FRENOS 		No. Lusac: 383150 Producto: MANGUERA DE FRENOS 	
DIAMETRO	24.09"	DIAMETRO	10.04"	DIAMETRO	14.49" & 6.73"
NISSAN ROGUE 08-14		NISSAN 370Z 09-14		INFINITI Q45 03-06	







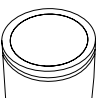

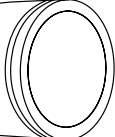



No. Lusac: 383151 Producto: MANGUERA DE FRENOS 		No. Lusac: 383152 Producto: MANGUERA DE FRENOS 		No. Lusac: 383153 Producto: MANGUERA DE FRENOS 	
DIAMETRO	8.07"	DIAMETRO	17.13"	DIAMETRO	11.93"
SAAB 9-5 WAGON 01-07		SAAB 9-3 04-09		SAAB 9-3 04-09	
No. Lusac: 383163 Producto: MANGUERA DE FRENOS 		No. Lusac: 383164 Producto: MANGUERA DE FRENOS 		No. Lusac: 383165 Producto: MANGUERA DE FRENOS 	
DIAMETRO	22.6"	DIAMETRO	22.6"	DIAMETRO	17.56"
TOYOTA RAV4 04-05		TOYOTA RAV4 04-05		TOYOTA LANDCRUISER 08-12	
No. Lusac: 383166 Producto: MANGUERA DE FRENOS 		No. Lusac: 383171 Producto: MANGUERA DE FRENOS 		No. Lusac: 383174 Producto: MANGUERA DE FRENOS 	
DIAMETRO	17.56"	DIAMETRO	21.81"	DIAMETRO	13.7"
TOYOTA LANDCRUISER 08-12		AUDI A3 02-03		AUDI A6 05-09 S6 07-11	









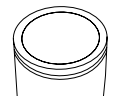

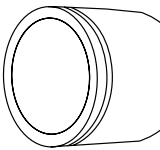



Fotografías de producto y especificaciones

No. Lusac: 383180 Producto: MANGUERA DE FRENOS 		No. Lusac: 383187 Producto: MANGUERA DE FRENOS 		No. Lusac: 383188 Producto: MANGUERA DE FRENOS 	
DIAMETRO	6.56"	DIAMETRO	11.56"	DIAMETRO	11.56"
AUDI A1 11-13 JETTA A4 06-10 A3 02-03 JETTA CLASICO 11-14 VOLKSWAGEN BEETLE GLS GLX 98-10		HONDA FIT 09-14		HONDA FIT 09-14	
No. Lusac: 383189 Producto: MANGUERA DE FRENOS 		No. Lusac: 383190 Producto: MANGUERA DE FRENOS 		No. Lusac: 383194 Producto: MANGUERA DE FRENOS 	
DIAMETRO	23"	DIAMETRO	20.24"	DIAMETRO	11.5" & 8.25"
HONDA CR-Z 13 FIT 09-14		HONDA CR-Z 13 FIT 09-14		CADILLAC CTS 08-12	
No. Lusac: 383195 Producto: MANGUERA DE FRENOS 		No. Lusac: 383200 Producto: MANGUERA DE FRENOS 		No. Lusac: 383201 Producto: MANGUERA DE FRENOS 	
DIAMETRO	12.38"	DIAMETRO	18.5"	DIAMETRO	18.5"
CADILLAC CTS 08-12		DODGE JOURNEY 09-14		DODGE JOURNEY 09-14	







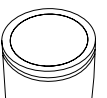

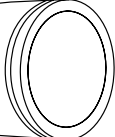



No. Lusac: 383202		No. Lusac: 383203		No. Lusac: 383204	
Producto: MANGUERA DE FRENOS		Producto: MANGUERA DE FRENOS		Producto: MANGUERA DE FRENOS	
					
DIAMETRO	9.53"	DIAMETRO	9.45"	DIAMETRO	10.83"
DODGE		DODGE		AUDI	
JOURNEY 09-14		JOURNEY 09-14		S8 01-02	
No. Lusac: 383208		No. Lusac: 383209		No. Lusac: 383211	
Producto: MANGUERA DE FRENOS		Producto: MANGUERA DE FRENOS		Producto: MANGUERA DE FRENOS	
					
DIAMETRO	10.35" & 12.80"	DIAMETRO	10.35" & 12.80"	DIAMETRO	20.00"
NISSAN		NISSAN		CHEVROLET	
350Z 03-08		350Z 03-08		CAMARO Z28 98-02 S420L 96-97	
				MERCEDEZ BENZ	
				S420 94-95 98-99	
No. Lusac: 383219		No. Lusac: 383220		No. Lusac: 383222	
Producto: MANGUERA DE FRENOS		Producto: MANGUERA DE FRENOS		Producto: MANGUERA DE FRENOS	
 Imagen Disponible Próximamente					
DIAMETRO	12.90"	DIAMETRO	21.2"	DIAMETRO	20.27"
MERCEDEZ BENZ		MERCEDEZ BENZ		SUBARU	
ML320 99-03 ML500 02-05 ML55AMG 01-03		ML320 99-03 ML350 06-08 ML500 02-05 ML55 AMG 01-03		IMPREZA 07-12	









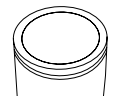



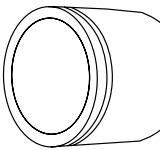

Fotografías de producto y especificaciones

No. Lusac: 383223 Producto: MANGUERA DE FRENOS 		No. Lusac: 383241 Producto: MANGUERA DE FRENOS 		No. Lusac: 383259 Producto: MANGUERA DE FRENOS 	
DIAMETRO	20.44"	DIAMETRO	26.38"	DIAMETRO	18.39"
SUBARU IMPREZA 07-12		FORD MONDEO SPORT XLS 03-04		HONDA CR-V 07-11	
No. Lusac: 383260 Producto: MANGUERA DE FRENOS 		No. Lusac: 383267 Producto: MANGUERA DE FRENOS 		No. Lusac: 383270 Producto: MANGUERA DE FRENOS 	
DIAMETRO	0.30"	DIAMETRO	20.51"	DIAMETRO	11.97"
CADILLAC XLR 04-06		CHEVROLET CORVETTE 05-13		PONTIAC SOLSTICE 06-09	
No. Lusac: 383276 Producto: MANGUERA DE FRENOS 		No. Lusac: 383277 Producto: MANGUERA DE FRENOS 		No. Lusac: 383283 Producto: MANGUERA DE FRENOS 	
DIAMETRO	6.22"	DIAMETRO	6.42"	DIAMETRO	8.07"
PONTIAC G4 05-06 G5 07-09		PONTIAC G4 05-06 G5 07-09		BMW 135i 09-13 328i 12-14 335i 09-14 M3 07-13	



Fotografías de producto y especificaciones





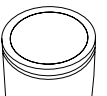

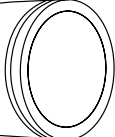



No. Lusac: 383291		No. Lusac: 383292		No. Lusac: 383293	
Producto: MANGUERA DE FRENOS		Producto: MANGUERA DE FRENOS		Producto: MANGUERA DE FRENOS	
					
DIAMETRO	0.30"	DIAMETRO	11.73"	DIAMETRO	9.96"
CHRYSLER 200 12-14		CHRYSLER 200 12-14		DODGE CALIBER 07-12	
DODGE AVENGER 08-12		JEEP PATRIOT 07-12		PATRIOT PATRIOT 07-12	
		DODGE AVENGER 08-12		JEEP COMPASS 07-12	
No. Lusac: 383294		No. Lusac: 383297		No. Lusac: 383311	
Producto: MANGUERA DE FRENOS		Producto: MANGUERA DE FRENOS		Producto: MANGUERA DE FRENOS	
					
Imagen Disponible Próximamente		Imagen Disponible Próximamente		Imagen Disponible Próximamente	
DIAMETRO	8.74"	DIAMETRO	0.30"	DIAMETRO	N/D
JEEP COMPASS 07-12 PATRIOT 07-12		DODGE RAM 2500 11-12		FORD F550 01-04	
No. Lusac: 383314		No. Lusac: 383316		No. Lusac: 383319	
Producto: MANGUERA DE FRENOS		Producto: MANGUERA DE FRENOS		Producto: MANGUERA DE FRENOS	
					
Imagen Disponible Próximamente		Imagen Disponible Próximamente		Imagen Disponible Próximamente	
DIAMETRO	0.30"	DIAMETRO	0.30"	DIAMETRO	N/D
FORD E150 ECONOLINE VAN 08-14 E250 ECONOLINE VAN 08-14		FORD FUSION SE 07-09		MERCURY MILAN 07-08	
		LINCOLN MKZ 07-08		TOYOTA YARIS 10-11	









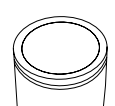

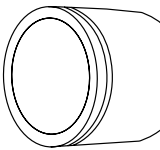
Fotografías de producto y especificaciones

No. Lusac: 383320 Producto: MANGUERA DE FRENOS  Imagen Disponible Próximamente		No. Lusac: 383321 Producto: MANGUERA DE FRENOS  Imagen Disponible Próximamente		No. Lusac: 383324 Producto: MANGUERA DE FRENOS 	
DIAMETRO	N/D	DIAMETRO	0.30"	DIAMETRO	19.53"
TOYOTA YARIS 10-11		TOYOTA YARIS 10-14		MAZDA CX-7 07-12	
No. Lusac: 383325 Producto: MANGUERA DE FRENOS 		No. Lusac: 383326 Producto: MANGUERA DE FRENOS  Imagen Disponible Próximamente		No. Lusac: 383327 Producto: MANGUERA DE FRENOS  Imagen Disponible Próximamente	
DIAMETRO	21.10"	DIAMETRO	N/D	DIAMETRO	N/D
MITSUBISHI LANCER EVOLUTION IX 06		TOYOTA COROLLA S 09-11 MATRIX XR 09-10		TOYOTA COROLLA S 09-11 MATRIX XR 09-10	
No. Lusac: 383329 Producto: MANGUERA DE FRENOS 		No. Lusac: 383331 Producto: MANGUERA DE FRENOS 		No. Lusac: 383333 Producto: MANGUERA DE FRENOS 	
DIAMETRO	21.61"	DIAMETRO	0.30"	DIAMETRO	15.43"
BMW 135i 09-13 Z4 10-14 10-14 328i 12-14 335i 09-14		NISSAN ALTIMA 07-14		NISSAN SENTRA 07-12	







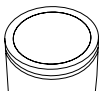

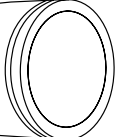



No. Lusac: 383335 Producto: MANGUERA DE FRENOS		No. Lusac: 383336 Producto: MANGUERA DE FRENOS		No. Lusac: 383338 Producto: MANGUERA DE FRENOS	
Lusac [®] Imagen Disponible Próximamente		Lusac [®] Imagen Disponible Próximamente		Lusac [®] Imagen Disponible Próximamente	
DIAMETRO	0.30"	DIAMETRO	0.30"	DIAMETRO	0.30"
TOYOTA HIGHLANDER 08-13		TOYOTA HIGHLANDER 08-13		DODGE RAM 2500 01-02	
No. Lusac: 383342 Producto: MANGUERA DE FRENOS		No. Lusac: 383343 Producto: MANGUERA DE FRENOS		No. Lusac: 383347 Producto: MANGUERA DE FRENOS	
					
DIAMETRO	26.69"	DIAMETRO	0.46"	DIAMETRO	17.12"
BUICK VERANO 13	CHEVROLET CRUZE 10-14	BUICK VERANO 13-13	CHEVROLET CRUZE 10-14	CHEVROLET CRUZE 11-14 11-14	
No. Lusac: 383350 Producto: MANGUERA DE FRENOS		No. Lusac: 383353 Producto: MANGUERA DE FRENOS		No. Lusac: 383354 Producto: MANGUERA DE FRENOS	
					
DIAMETRO	10.00"	DIAMETRO	21.25"	DIAMETRO	23.38"
DODGE CALIBER 07-12	JEEP PATRIOT 07-12	AUDI Q7 07-13	VOLKSWAGEN TIGUAN 09-14 TOUAREG 04-11	CHEVROLET TRAILBLAZER 02-07	
		PORSCHE CAYENNE 03-12			





Fotografías de producto y especificaciones

No. Lusac: 383355 Producto: MANGUERA DE FRENOS 		No. Lusac: 383357 Producto: MANGUERA DE FRENOS 		No. Lusac: 383358 Producto: MANGUERA DE FRENOS 	
DIAMETRO	23.25"	DIAMETRO	8.75"	DIAMETRO	8.78"
CHEVROLET TRAILBLAZER 02-07		DODGE RAM 1500 03-06		DODGE RAM 1500 03-06	
No. Lusac: 383359 Producto: MANGUERA DE FRENOS  Imagen Disponible Próximamente		No. Lusac: 383360 Producto: MANGUERA DE FRENOS  Imagen Disponible Próximamente		No. Lusac: 383384 Producto: MANGUERA DE FRENOS  Imagen Disponible Próximamente	
DIAMETRO	N/D	DIAMETRO	N/D	DIAMETRO	0.30"
AUDI TT 00-06 VOLKSWAGEN JETTA A4 EUROPA TDI 02-10		AUDI TT 00-06 VOLKSWAGEN JETTA A4 EUROPA TDI 02-10		CHEVROLET EQUINOX 07-08	
No. Lusac: 383388 Producto: MANGUERA DE FRENOS  Imagen Disponible Próximamente		No. Lusac: 383389 Producto: MANGUERA DE FRENOS  Imagen Disponible Próximamente		No. Lusac: 383390 Producto: MANGUERA DE FRENOS 	
DIAMETRO	0.20"	DIAMETRO	0.30"	DIAMETRO	0.30"
TOYOTA COROLLA S 09-14		TOYOTA MATRIX XR 09-10		TOYOTA MATRIX XR 09-10	

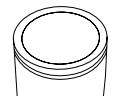

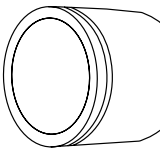

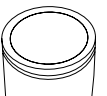

No. Lusac: 383401		No. Lusac: 383402		No. Lusac: 383403	
Producto: MANGUERA DE FRENOS		Producto: MANGUERA DE FRENOS		Producto: MANGUERA DE FRENOS	
DIAMETRO	0.30"	DIAMETRO	0.30"	DIAMETRO	0.30"
CHEVROLET		CHEVROLET		CHEVROLET	
CAMARO LT Y SS 10-13		CAMARO LT Y SS 10-13		CAMARO LT Y SS 10-13	
No. Lusac: 383404		No. Lusac: 383405		No. Lusac: 383406	
Producto: MANGUERA DE FRENOS		Producto: MANGUERA DE FRENOS		Producto: MANGUERA DE FRENOS	
DIAMETRO	0.30"	DIAMETRO	0.30"	DIAMETRO	0.30"
CHEVROLET		CHEVROLET		CHEVROLET	
CAMARO LT Y SS 10-13		CAMARO LT Y SS 10-13		CAMARO LT Y SS 10-13	
No. Lusac: 383407		No. Lusac: 383409		No. Lusac: 383410	
Producto: MANGUERA DE FRENOS		Producto: MANGUERA DE FRENOS		Producto: MANGUERA DE FRENOS	
DIAMETRO	0.30"	DIAMETRO	16.73"	DIAMETRO	16.73"
Lusac [®]		Lusac [®]		Lusac [®]	
Imagen Disponible Próximamente		Imagen Disponible Próximamente		Imagen Disponible Próximamente	
CADILLAC		CADILLAC		CADILLAC	
ESCALADE ESV 07-14		SRX 10-14		SRX 10-14	
CHEVROLET					
AVALANCHE 07-13					
SUBURBAN 1500 07-13					
TAHOE 07-14					

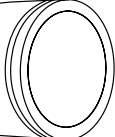







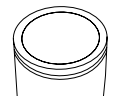

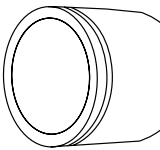



Fotografías de producto y especificaciones

No. Lusac: 383411 Producto: MANGUERA DE FRENOS  Imagen Disponible Próximamente		No. Lusac: 383412 Producto: MANGUERA DE FRENOS  Imagen Disponible Próximamente		No. Lusac: 383417 Producto: MANGUERA DE FRENOS 	
DIAMETRO	20.47"	DIAMETRO	20.51"	DIAMETRO	N/D
CADILLAC SRX 10-14		CADILLAC SRX 10-14		MINI COOPER S 09-13	
No. Lusac: 383420 Producto: MANGUERA DE FRENOS  Imagen Disponible Próximamente		No. Lusac: 383421 Producto: MANGUERA DE FRENOS  Imagen Disponible Próximamente		No. Lusac: 383426 Producto: MANGUERA DE FRENOS  Imagen Disponible Próximamente	
DIAMETRO	N/D	DIAMETRO	N/D	DIAMETRO	N/D
HONDA PILOT 09-14		HONDA PILOT 09-14		HONDA CIVIC 12-13	
No. Lusac: 383427 Producto: MANGUERA DE FRENOS  Imagen Disponible Próximamente		No. Lusac: 383428 Producto: MANGUERA DE FRENOS 		No. Lusac: 383435 Producto: MANGUERA DE FRENOS 	
DIAMETRO	N/D	DIAMETRO	N/D	DIAMETRO	N/D
HONDA CIVIC 12-13		VOLKSWAGEN BORA GLI TURBO 06-10 EOS 10 GOLF A5 GTI 07-08		SUBARU LEGACY 06-14	







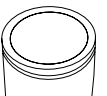

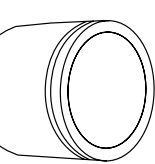

<p>No. Lusac: 383436</p> <p>Producto: MANGUERA DE FRENOS</p> 		<p>No. Lusac: 383442</p> <p>Producto: MANGUERA DE FRENOS</p>  <p>Imagen Disponible Próximamente</p>		<p>No. Lusac: 383443</p> <p>Producto: MANGUERA DE FRENOS</p>  <p>Imagen Disponible Próximamente</p>	
DIAMETRO	N/D	DIAMETRO	N/D	DIAMETRO	N/D
<p>ACURA ILX 13-14</p>		<p>SUBARU LEGACY 06-14</p>		<p>TOYOTA YARIS 12-14</p>	
<p>No. Lusac: 383444</p> <p>Producto: MANGUERA DE FRENOS</p>  <p>Imagen Disponible Próximamente</p>		<p>No. Lusac: 383445</p> <p>Producto: MANGUERA DE FRENOS</p>  <p>Imagen Disponible Próximamente</p>		<p>No. Lusac: 383449</p> <p>Producto: MANGUERA DE FRENOS</p>  <p>Imagen Disponible Próximamente</p>	
DIAMETRO	N/D	DIAMETRO	N/D	DIAMETRO	N/D
<p>TOYOTA PRIUS 10-13</p>		<p>TOYOTA PRIUS 10-13</p>		<p>VOLKSWAGEN ROUTAN 11-12</p>	
<p>No. Lusac: 383450</p> <p>Producto: MANGUERA DE FRENOS</p>  <p>Imagen Disponible Próximamente</p>		<p>No. Lusac: 383467</p> <p>Producto: MANGUERA DE FRENOS</p>  <p>Imagen Disponible Próximamente</p>		<p>No. Lusac: 383468</p> <p>Producto: MANGUERA DE FRENOS</p>  <p>Imagen Disponible Próximamente</p>	
DIAMETRO	N/D	DIAMETRO	N/D	DIAMETRO	N/D
<p>VOLKSWAGEN ROUTAN 11-12</p>		<p>TOYOTA PRIUS 10-13</p>		<p>TOYOTA PRIUS 10-13</p>	









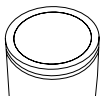

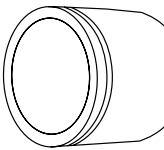
Fotografías de producto y especificaciones

No. Lusac: 383476 Producto: MANGUERA DE FRENOS  Imagen Disponible Próximamente		No. Lusac: 383477 Producto: MANGUERA DE FRENOS  Imagen Disponible Próximamente		No. Lusac: 7838625 Producto: MANGUERA DE FRENOS  Imagen Disponible Próximamente	
DIAMETRO	N/D	DIAMETRO	N/D	DIAMETRO	17 7/8"
NISSAN JUKE 12-14		NISSAN JUKE 12-14		FORD F150 84-91 F200 87-91	
No. Lusac: 2032M Producto: MANGUERA DE FRENOS 		No. Lusac: 5022M Producto: MANGUERA DE FRENOS 		No. Lusac: 7005M Producto: MANGUERA DE FRENOS 	
DIAMETRO	11"	DIAMETRO	13"	DIAMETRO	10 3/4"
NISSAN TSURU II 88-92		FORD THUNDERBIRD 85-89		VOLKSWAGEN SEDAN 83-04	
No. Lusac: 7007M Producto: MANGUERA DE FRENOS 					
DIAMETRO	7 1/4"				
VOLKSWAGEN ATLANTIC 81-87 EUROVAN 00-04 CARIBE 78-87 GOLF 87-99 CORSAR 84-88 JETTA A2 87-92 DERBY 95-97					







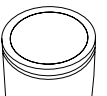

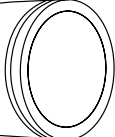



No. Lusac: 832		No. Lusac: 2160		No. Lusac: 2724	
Producto: PISTÓN FRENO DE DISCO		Producto: PISTÓN FRENO DE DISCO		Producto: PISTÓN FRENO DE DISCO	
					
DIAMETRO	48.0 mm 1-57/64"	DIAMETRO	50.8 mm 2"	DIAMETRO	50.8 mm 2"
CHEVROLET CHEVY C2, JOY, POP, VAGONETA SWING 95-08 CHEVY PICKUP 99-03		CHEVROLET C2500 96-99 SONORA 00-06 EXPRESS 1500 CARGO VAN 07- 13 SUBURBAN 1500 2500 00-06 SILVERADO 1500 00-01 03-06 SILVERADO 2500 CHEYENNE 02, 07-10		DODGE ATOS 01-12	
No. Lusac: 2900		No. Lusac: 2902		No. Lusac: 2904	
Producto: PISTÓN FRENO DE DISCO		Producto: PISTÓN FRENO DE DISCO		Producto: PISTÓN FRENO DE DISCO	
					
DIAMETRO	48.0 mm 1-57/64"	DIAMETRO	54.0 mm 2-1/8"	DIAMETRO	54.0 mm 2-1/8"
VOLKSWAGEN POINTER CITY INC, PICKUP, VAGONETA, PICKUP TRENDLINE VAGONETA 98-07		SEAT ALHAMBRA 02-03 CROSSFOX 07-09 CORDOBA 02-09 GOLF A3 GTI VR6 A4 GTI 99-00 IBIZA 01-09 JETTA A3 VR6 A4 95-09 LEON 01-09 JETTA CLASICO 11-13 TOLEDO 01-06 LUPO 05-09 VOLKSWAGEN BEETLE GLS GLX 98-10 POLO 03-07		VOLKSWAGEN POINTER CITY GTI INC VAGONETA 98-09	









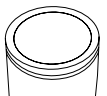



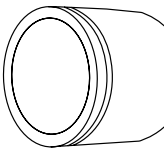

Fotografías de producto y especificaciones

No. Lusac: 6000 Producto: PISTÓN FRENO DE DISCO 		No. Lusac: 76008 Producto: PISTÓN FRENO DE DISCO 		No. Lusac: 76021 Producto: PISTÓN FRENO DE DISCO 	
DIAMETRO	48.0 mm 1-57/64"	DIAMETRO	74.6 mm 2-15/16"	DIAMETRO	78.6 mm 3-3/32"
CHEVROLET TRACKER 98-02 SENTRA 92-92 TRAILBLAZER 02-07 TSUBAME 93-04 NISSAN HIKARI 88-92 TSURU II III GS 88-15		CHEVROLET JEEP C15 82-86 WAGONEER 85-86 C20 79-86 CHEVY VAN 95		DODGE D150 83-93 W150 85-87 D250 86-93 W250 86-93 D350 81-93	
No. Lusac: 76024 Producto: PISTÓN FRENO DE DISCO 		No. Lusac: 76026 Producto: PISTÓN FRENO DE DISCO 		No. Lusac: 76028 Producto: PISTÓN FRENO DE DISCO 	
DIAMETRO	73.0 mm 2-7/8"	DIAMETRO	78.6 mm 3-3/32"	DIAMETRO	85.7 mm 3-3/8"
FORD F150 84-93 F200 86-86		DODGE RAM 3500 MAXI WAGON 95-97 RAM VAN 3500 95-97 RAM CHARGER 86-93 95-96 RAM WAGON 1500 95-97 RAM VAN 1500 95-97 RAM WAGON 2500 96-97 RAM VAN 2500 96-97		CHEVROLET C30 84-86 MICROBUS 88-96 C3500 96-99 P30 PANEL PANEL 90-92 94-98 C3500HD 96-99	
No. Lusac: 76033 Producto: PISTÓN FRENO DE DISCO 		No. Lusac: 85013 Producto: PISTÓN FRENO DE DISCO 		No. Lusac: 85019 Producto: PISTÓN FRENO DE DISCO 	
DIAMETRO	63.5 mm 2-1/2"	DIAMETRO	50.8 mm 2"	DIAMETRO	73.0 mm 2-7/8"
BUICK OLDSMOBILE CENTURY 83-96 CUTLASS 90-96 CHEVROLET EUROSPOUT 91-96 BLAZER 95-97 SILHOUETTE 91 S-10 95-04		FORD LINCOLN F150 97-99 BLACKWOOD 03-03 LOBO 01-04		FORD E150 ECONLINE WAGON VAN 95-07 F150 94-99 E250 ECONOLINE VAN 99-07 E350 ECONOLINE CLUB WAGON 97-98	



Fotografías de producto y especificaciones



No. Lusac: 85029 Producto: PISTÓN FRENO DE DISCO 		No. Lusac: 85038 Producto: PISTÓN FRENO DE DISCO 		No. Lusac: 85055 Producto: PISTÓN FRENO DE DISCO 	
DIAMETRO	57.1 mm 2-1/4"	DIAMETRO	69.8 mm 2-3/4"	DIAMETRO	66.7 mm 2-5/8"
CHRYSLER PT CRUISER 01-05 09-10		DODGE DURANGO 98-02		FORD AEROSTAR 91-95 EXPLORER 91-94	
No. Lusac: 85088 Producto: PISTÓN FRENO DE DISCO 		No. Lusac: 85119 Producto: PISTÓN FRENO DE DISCO 		No. Lusac: 85135 Producto: PISTÓN FRENO DE DISCO 	
DIAMETRO	63.5 mm 2-1/2"	DIAMETRO	45.0 mm	DIAMETRO	64.3 mm 2-17/32"
CADILLAC DEVILLE 97-04 SEVILLE STS 98-01 03-04 CHEVROLET IMPALA 00-04 UPLANDER 05-09 VENTURE APV 97-04		PONTIAC GRAND PRIX 97-01 MONTANA SV6 05-09 TORRENT 06-06		CADILLAC ESCALADE 02-06 CHEVROLET SONORA 00-06 SUBURBAN 1500 2500 00-06	
		FORD TRAILBLAZER 02-07 MUSTANG GT 98-04		HONDA ODYSSEY 00-10	
No. Lusac: 85148 Producto: PISTÓN FRENO DE DISCO 		No. Lusac: 85152 Producto: PISTÓN FRENO DE DISCO 		No. Lusac: 85153 Producto: PISTÓN FRENO DE DISCO 	
DIAMETRO	46.4 mm 1-53/64"	DIAMETRO	64.0 mm	DIAMETRO	66.0 mm
NISSAN XTERRA 00-07		CHRYSLER GRAND VOYAGER 01-02 TOWN & COUNTRY 01-06 VOYAGER 01-05		PONTIAC AZTEK 01-05	
		CHRYSLER TOWN & COUNTRY 08-12 DODGE JOURNEY 09-12 NITRO 07-10		JEEP LIBERTY 02-13 WRANGLER 07-10	

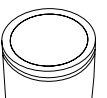

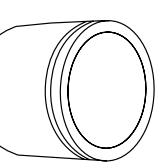

Fotografías de producto y especificaciones

<p>No. Lusac: 85155</p> <p>Producto: PISTÓN FRENO DE DISCO</p> 		<p>No. Lusac: 85156</p> <p>Producto: PISTÓN FRENO DE DISCO</p> 		<p>No. Lusac: 85157</p> <p>Producto: PISTÓN FRENO DE DISCO</p> 	
DIAMETRO	59.5 mm 2-11/32"	DIAMETRO	80.2 mm 3-5/32"	DIAMETRO	74.6 mm 2-15/16"
<p>FORD</p> <p>E350 ECONOLINE CLUB WAGON 95-96</p> <p>F450 97-02</p>		<p>CHEVROLET</p> <p>C3500 89-95</p> <p>EXPRESS 3500 CARGO VAN 97-02</p>		<p>CADILLAC</p> <p>ESCALADE 03-06 SONORA 00-06</p> <p>CHEVROLET SUBURBAN 1500 2500 00-06</p> <p>C1500 94-99</p> <p>C2500 CHEYENNE 92-99</p> <p>EXPRESS 1500 CARGO VAN 98-06</p> <p>EXPRESS 2500, CARGO VAN 04-06, 98-99</p> <p>SILVERADO 1500 00-01 03-06</p> <p>SILVERADO 3500 01-06</p> <p>DODGE</p> <p>D250 91-92</p> <p>RAM 1500 94-00</p> <p>RAM 2500 94-00</p>	
<p>No. Lusac: 85158</p> <p>Producto: PISTÓN FRENO DE DISCO</p> 		<p>No. Lusac: 85159</p> <p>Producto: PISTÓN FRENO DE DISCO</p> 		<p>No. Lusac: 85163</p> <p>Producto: PISTÓN FRENO DE DISCO</p> 	
DIAMETRO	63.5 mm 2-1/2"	DIAMETRO	42.1 mm 1-21/32"	DIAMETRO	36.1 mm 1-27/64"
<p>CHEVROLET</p> <p>C1500 88-91</p> <p>C2500 89-91</p>		<p>BUICK</p> <p>REGAL 94-96</p>		<p>CHRYSLER</p> <p>300M 99-04</p> <p>CIRRUS 01-05</p> <p>CONCORDE 01-02</p> <p>IMPERIAL 91</p> <p>PT CRUISER 01-05 09-10</p> <p>DODGE</p> <p>STRATUS 98-05</p> <p>INTREPID 98-01</p>	

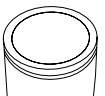

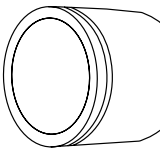



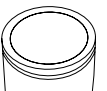

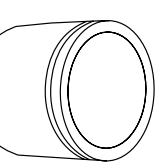



<p>No. Lusac: 85167</p> <p>Producto: PISTÓN FRENO DE DISCO</p> 		<p>No. Lusac: 85168</p> <p>Producto: PISTÓN FRENO DE DISCO</p> 		<p>No. Lusac: 85171</p> <p>Producto: PISTÓN FRENO DE DISCO</p> 	
DIAMETRO	39.7 mm 1-9/16"	DIAMETRO	38.1 mm 1-1/2"	DIAMETRO	65.9 mm 2-19/32"
<p>CHEVROLET</p> <p>CAMARO 95-97 CORVETTE 91-96</p>		<p>CHEVROLET</p> <p>CORVETTE 91-96</p>		<p>FORD</p> <p>THUNDERBIRD 89-92</p>	
<p>No. Lusac: 85177</p> <p>Producto: PISTÓN FRENO DE DISCO</p> 		<p>No. Lusac: 85179</p> <p>Producto: PISTÓN FRENO DE DISCO</p> 		<p>No. Lusac: 85196</p> <p>Producto: PISTÓN FRENO DE DISCO</p>  <p>Imagen Disponible Próximamente</p>	
DIAMETRO	42.8 mm 1-11/16"	DIAMETRO	42.8 mm 1-11/16"	DIAMETRO	30.1 mm 1-3/16"
<p>NISSAN</p> <p>FRONTIER, D22 09-11, 01-04 URVAN CARGA 00-01 PATHFINDER 97-98 PICKUP NISSAN, NP300 80-97, 09-14</p>		<p>INFINITI</p> <p>Q45 94-96</p>		<p>HONDA</p> <p>ACCORD 96-07</p>	
<p>No. Lusac: 85206</p> <p>Producto: PISTÓN FRENO DE DISCO</p> 		<p>No. Lusac: 85209</p> <p>Producto: PISTÓN FRENO DE DISCO</p> 		<p>No. Lusac: 85213</p> <p>Producto: PISTÓN FRENO DE DISCO</p> 	
DIAMETRO	86.1 mm 3-25/64"	DIAMETRO	54.0 mm 2-1/8"	DIAMETRO	40.5 mm 1-19/32"
<p>CHEVROLET</p> <p>C3500 90-90 92-99 C3500HD 96-99 P30 PANEL 98-01</p>		<p>DODGE</p> <p>RAM 3500 94-99 RAM 4000 95-97 99-99 RAM SRT-10 05-06</p>		<p>CHEVROLET</p> <p>AVEO 08-15 OPTRA 06-10</p> <p>DODGE</p> <p>VERNA 04-06</p> <p>NISSAN</p> <p>LUCINO GSE GSR 96-00 SENI IKA GSS DE 90-00 U1-U1 06 00 TSURU GSR 2000 95-96</p>	
		<p>NISSAN</p> <p>300ZX 91-96</p>			
		<p>NISSAN</p> <p>LANCER DE, ES, RALLIART 06-10</p>			









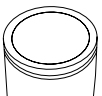

Fotografías de producto y especificaciones

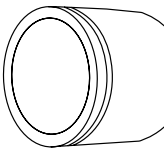
No. Lusac: 85215 Producto: PISTÓN FRENO DE DISCO 		No. Lusac: 85216 Producto: PISTÓN FRENO DE DISCO 		No. Lusac: 85218 Producto: PISTÓN FRENO DE DISCO 	
DIAMETRO	48.0 mm 1-57/64"	DIAMETRO	44.4 mm 1-3/4"	DIAMETRO	57.1 mm 2-1/4"
NISSAN APRIO 08-08 10-10 EURO CLIO AUTENTIQUE 07 PLATINA 02-10 SANDERO 10-12 RENAULT CLIO ENERGY EXPRESSION SPORT 02-10		NISSAN FRONTIER 01-04 X-TRAIL 02-10 PATHFINDER 99-04		NISSAN ALMERA COMFORT 01-05	
No. Lusac: 85225 Producto: PISTÓN FRENO DE DISCO 		No. Lusac: 85242 Producto: PISTÓN FRENO DE DISCO 		No. Lusac: 85258 Producto: PISTÓN FRENO DE DISCO 	
DIAMETRO	38.1 mm 1-1/2"	DIAMETRO	50.8 mm 2"	DIAMETRO	54.0 mm 2-1/8"
FORD THUNDERBIRD 03-04		FORD FREESTAR 04-07		CHEVROLET MERIVA 04-08	
No. Lusac: 85261 Producto: PISTÓN FRENO DE DISCO 		No. Lusac: 85262 Producto: PISTÓN FRENO DE DISCO 		No. Lusac: 85275 Producto: PISTÓN FRENO DE DISCO 	
DIAMETRO	57.1 mm 2-1/4"	DIAMETRO	40.0 mm	DIAMETRO	45.0 mm
CADILLAC CATERA 97-01		CADILLAC CATERA 97-01		CHEVROLET PONTIAC CAMARO Z28 98-02 FIREBIRD TRANS AM 98-01	



Fotografías de producto y especificaciones





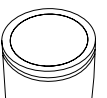

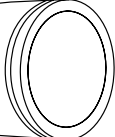



No. Lusac: 85384 Producto: PISTÓN FRENO DE DISCO		No. Lusac: 85388 Producto: PISTÓN FRENO DE DISCO		No. Lusac: 85389 Producto: PISTÓN FRENO DE DISCO	
					
DIAMETRO	54.0 mm 2-1/8"	DIAMETRO	63.5 mm 2-1/2"	DIAMETRO	57.1 mm 2-1/4"
FORD ESCORT GT VAGONETA 94-99		CADILLAC DEVILLE CONCOURS 91-96 ELDORADO 94-97 SEVILLE 94-97 CHEVROLET CAMARO 95-97 LUMINA 95-96		OLDSMOBILE EIGHTY EIGHT 92, 94-95 SILHOUETTE 92, 94-95 PONTIAC BONNEVILLE 94-99 FIREBIRD TRANS AM 94-97	
CHEVROLET CAVALIER Z24 92-04		PONTIAC SUNFIRE 97-02 04-05			
No. Lusac: 85390 Producto: PISTÓN FRENO DE DISCO		No. Lusac: 85391 Producto: PISTÓN FRENO DE DISCO		No. Lusac: 85392 Producto: PISTÓN FRENO DE DISCO	
					
DIAMETRO	48.0 mm 1-57/64"	DIAMETRO	57.1 mm 2-1/4"	DIAMETRO	66.0 mm
CHEVROLET CORSA 02-08 TORNADO 04-11		CHEVROLET ASTRA INC VAGONETA 00-08 ZAFIRA 02-06		VOLKSWAGEN PASSAT 06-10	
		AUDI A4 02-11		JEEP CHEROKEE SPORT SPORT 94, 98-01 GRAND CHEROKEE 93-98 WRANGLER 93-95 97-06	
		CHRYSLER TOWN & COUNTRY 01-06 VOYAGER 01-05			













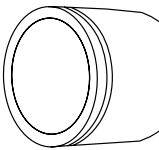

Fotografías de producto y especificaciones

No. Lusac: 85393 Producto: PISTÓN FRENO DE DISCO 		No. Lusac: 85402 Producto: PISTÓN FRENO DE DISCO 		No. Lusac: 85424 Producto: PISTÓN FRENO DE DISCO 	
DIAMETRO	57.1 mm 2-1/4"	DIAMETRO	54.0 mm 2-1/8"	DIAMETRO	47.6 mm 1-7/8"
FORD MONDEO CORE GHIA TREND 01-07		HONDA ACCORD 96-12		FORD GRAND MARQUIS 92-04	
HONDA CIVIC 97-13		NISSAN TIIDA 07-14		LINCOLN TOWN CAR 91-00	
No. Lusac: 85425 Producto: PISTÓN FRENO DE DISCO 		No. Lusac: 85438 Producto: PISTÓN FRENO DE DISCO 		No. Lusac: 85456 Producto: PISTÓN FRENO DE DISCO 	
DIAMETRO	38.1 mm 1-1/2"	DIAMETRO	65.9 mm 2-19/32"	DIAMETRO	48.0 mm 1-57/64"
INFINITI Q45 94-96		FORD GRAND MARQUIS 95-97 WINDSTAR 95-98		FORD EXPLORER EDDIE BAUER SPORT 94-10	
		LINCOLN CONTINENTAL 97-99 MARK VIII 94-96		MERCURY SABLE VAGONETA 94-04	
				JEEP GRAND CHEROKEE 95-98 LIBERTY 02-13	
				LINCOLN AVIATOR 03-05	
No. Lusac: 85469 Producto: PISTÓN FRENO DE DISCO 		No. Lusac: 85470 Producto: PISTÓN FRENO DE DISCO 		No. Lusac: 85471 Producto: PISTÓN FRENO DE DISCO 	
DIAMETRO	54.0 mm 2-1/8"	DIAMETRO	60.3 mm 2-3/8"	DIAMETRO	59.5 mm 2-11/32"
CHRYSLER CIRRUS 96-05 SEBRING RT 97-97		CHRYSLER CIRRUS TOURING LIMITED 01-06 STRATUS 98-06		CHEVROLET SILVERADO 3500 03-06	
				FORD F450 03-14	
				FORD F550 01-14	



Fotografías de producto y especificaciones





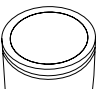

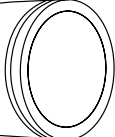



No. Lusac: 85472 Producto: PISTÓN FRENO DE DISCO		No. Lusac: 85475 Producto: PISTÓN FRENO DE DISCO		No. Lusac: 85476 Producto: PISTÓN FRENO DE DISCO	
					
DIAMETRO	57.1 mm 2-1/4"	DIAMETRO	46.0 mm 1-13/16"	DIAMETRO	38.1 mm 1-1/2"
INFINITI I30 98-00 NISSAN 240SX 93, 98 ALTIMA 96-12		CHEVROLET BLAZER 98-01 TRAILBLAZER 02-06		CHEVROLET IMPALA 00-04 VENTURE APV 98-04 HONDA PILOT 03-08 MITSUBISHI OUTLANDER 04-10 PONTIAC AZTEK 01-05	
MAXIMA SE 95-08 SENTRA SE-R 01-12		GRAND PRIX 97-01 MONTANA SV6 05-07 TORRENT 06 TOYOTA CAMRY LE 02-11 SOLARA 05-06			
No. Lusac: 85477 Producto: PISTÓN FRENO DE DISCO		No. Lusac: 85484 Producto: PISTÓN FRENO DE DISCO		No. Lusac: 85486 Producto: PISTÓN FRENO DE DISCO	
					
DIAMETRO	48.0 mm 1-57/64"	DIAMETRO	60.3 mm 2-3/8"	DIAMETRO	47.6 mm 1-7/8"
FORD F150 XL 97-04 GRAND MARQUIS 98-04 LOBO 04		LINCOLN TOWN CAR 98-07		CHEVROLET LUV 97-05	
NISSAN QUEST 04-09 URVAN CARGA CARGA 00-11					
No. Lusac: 85488 Producto: PISTÓN FRENO DE DISCO		No. Lusac: 85489 Producto: PISTÓN FRENO DE DISCO		No. Lusac: 85491 Producto: PISTÓN FRENO DE DISCO	
					
DIAMETRO	45.0 mm	DIAMETRO	45.0 mm	DIAMETRO	48.0 mm 1-57/64"
CHEVROLET CAMARO Z28 98-02		PONTIAC FIREBIRD TRANS AM 98-01		DODGE RAM 1500 03-08 RAM 2500 01-02 RAM 4000 05-08	
RAM MEGA CAB LARAMIE 06-08		FORD EXPLORER EDDIE BAUER SPORT 94-10		LINCOLN AVIATOR 03-05	









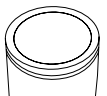



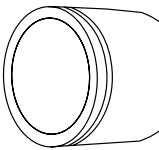

Fotografías de producto y especificaciones

No. Lusac: 85492 Producto: PISTÓN FRENO DE DISCO 		No. Lusac: 85493 Producto: PISTÓN FRENO DE DISCO 		No. Lusac: 85496 Producto: PISTÓN FRENO DE DISCO 	
DIAMETRO	44.0 mm	DIAMETRO	38.1 mm 1-1/2"	DIAMETRO	48.0 mm 1-57/64"
FORD WINDSTAR 95-03		PONTIAC GRAND AM 99-05		CHEVROLET MATIZ 04-11	
No. Lusac: 85800 Producto: PISTÓN FRENO DE DISCO 		No. Lusac: 85810 Producto: PISTÓN FRENO DE DISCO 		No. Lusac: 85812 Producto: PISTÓN FRENO DE DISCO 	
DIAMETRO	60.0 mm	DIAMETRO	54.0 mm 2-1/8"	DIAMETRO	54.0 mm 2-1/8"
FORD CONTOUR 96-00 ESCAPE 01-10		AUDI A1 11-13 A3 98-14 S3 11-12 FORD EXPEDITION 03-06 FOCUS EUROPA LX SVT ZX3 00-07 LINCOLN NAVIGATOR 03-06		MERCURY MARINER 05-09 MYSTIQUE 95-00	
		VOLKSWAGEN BEETLE 98-14 BORA GLI TURBO 06-10 GOLF A4 06-07 JETTA A3 VR6 A4 BASE, EUROPA, TDI, TRENDLINE 99-10 JETTA CLASICO 11-14		FIAT PALIO 04-11 FORD COURIER PICKUP 01-10 ECOSPORT 04-10 FIESTA 98-01 03-14	
				IKON 01-07 KA 01-08 VOLKSWAGEN POINTER VAGONETA 99-02	
No. Lusac: 85813 Producto: PISTÓN FRENO DE DISCO 		No. Lusac: 85814 Producto: PISTÓN FRENO DE DISCO 		No. Lusac: 85815 Producto: PISTÓN FRENO DE DISCO 	
DIAMETRO	48.0 mm 1-57/64"	DIAMETRO	48.0 mm 1-57/64"	DIAMETRO	54.0 mm 2-1/8"
FORD FIESTA 98-01 03-06 IKON 01-01		MINI COOPER 02-06		FORD WINDSTAR 99-03	
				FORD EXCURSION 01-05 F250 XL 99	
				F350 99-04	



Fotografías de producto y especificaciones





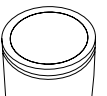

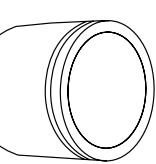

No. Lusac: 85817 Producto: PISTÓN FRENO DE DISCO		No. Lusac: 85826 Producto: PISTÓN FRENO DE DISCO		No. Lusac: 85827 Producto: PISTÓN FRENO DE DISCO	
					
DIAMETRO	48.0 mm 1-57/64"	DIAMETRO	50.8 mm 2"	DIAMETRO	50.8 mm 2"
FORD F150 97-03		FORD LINCOLN EXPEDITION 97-02 NAVIGATOR 98-02 F250 XL 97-99		FORD LINCOLN EXPEDITION 97-02 NAVIGATOR 98-02 F150 XL 04-04 97-03 TOWN CAR 03-06 F250 XL 97-99 LOBO 01-04	
No. Lusac: 85857 Producto: PISTÓN FRENO DE DISCO		No. Lusac: 85860 Producto: PISTÓN FRENO DE DISCO		No. Lusac: 96363 Producto: PISTÓN FRENO DE DISCO	
					
DIAMETRO	46.0 mm 1-13/16"	DIAMETRO	54.0 mm 2-1/8"	DIAMETRO	40.0 mm
CHEVROLET EQUINOX 05-08 RANGER 96-11 FORD EXPLORER EDDIE BAUER 95-02		NISSAN MICRA 05-07 CORDOBA 03-09 PEUGEOT 206 INC XR, XT 00-10 TOLEDO 01-03 307 03-07 VOLKSWAGEN PARTNER 04-09 CABRIO A4 00-02 RENAULT MEGANE II SPORT 01-10 EUROVAN 00-04 SCENIC II 01-09 GOLF A3 GTI VR6 93-99 TRAFFIC 08-09 JETTA 93-99 SEAT ALHAMBRA 02-03		VOLKSWAGEN SEDAN 95-04	
No. Lusac: 96373 Producto: PISTÓN FRENO DE DISCO		No. Lusac: 96542 Producto: PISTÓN FRENO DE DISCO		No. Lusac: 98728 Producto: PISTÓN FRENO DE DISCO	
					
DIAMETRO	54.0 mm 2-1/8"	DIAMETRO	60.3 mm 2-3/8"	DIAMETRO	48.0 mm 1-57/64"
VOLKSWAGEN COMBI 90-01 PANEL 90-01		NISSAN ICHI VAN 87-94 PICKUP 80-97		VOLKSWAGEN CABRIO A3 96-99 GOLF A2 GTI 87-99 CORSAR 84-88 JETTA A2 87-99 DERBY 95-00	









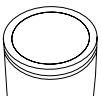



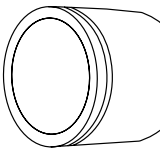

Fotografías de producto y especificaciones

No. Lusac: 98899		No. Lusac: 99080		No. Lusac: 99980	
Producto: PISTÓN FRENO DE DISCO		Producto: PISTÓN FRENO DE DISCO		Producto: PISTÓN FRENO DE DISCO	
					
DIAMETRO	73.0 mm 2-7/8"	DIAMETRO	60.0 mm	DIAMETRO	55.6 mm 2-3/16"
FORD GRAND MARQUIS 92-94		LINCOLN TOWN CAR 91-94		FORD F200 86-91 F250 92-94	
FORD THUNDERBIRD 85-88 93-96		FORD COUGAR 90-95			
No. Lusac: 100799		No. Lusac: 107534		No. Lusac: 108159	
Producto: PISTÓN FRENO DE DISCO		Producto: PISTÓN FRENO DE DISCO		Producto: PISTÓN FRENO DE DISCO	
					
DIAMETRO	57.1 mm 2-1/4"	DIAMETRO	54.0 mm 2-1/8"	DIAMETRO	60.0 mm
CHEVROLET CAVALIER Z24 90-91 CELEBRITY 85-89 CITATION 82-85		OLDSMOBILE CUTLASS 87-89		CHRYSLER ASPEN 07-09 LE BARON K 83-87 NEON 95-05 NEW YORKER 85-89 PHANTOM 87-89 DODGE DURANGO 03-09 RAM 1500 ST 01-12 RAM 2500 01-02	
		CHRYSLER RAM VAN 1500 98-03 RAM VAN Wagon 2500 98-02 RAM WAGON 1500 98-03 RAM WAGON 2500 98-02 SERIE 600K 84-85 SHADOW GTS 89-94 SPIRIT 90-95		CHRYSLER 300M 99-04 CONCORDE 93-97 01-02 GRAND VOYAGER 95-00 IMPERIAL 91 LE BARON 92-95 NEW YORKER 90-96 PHANTOM 90-94 TOWN & COUNTRY 93-00 VOYAGER 95-00	
				DODGE INTREPID 94-01 SPIRIT RT 91-95 FORD GHIA 91-94 TOPAZ 84-94 NISSAN QUEST 97-02	



Fotografías de producto y especificaciones



No. Lusac: 115614 Producto: PISTÓN FRENO DE DISCO 		No. Lusac: 119043 Producto: PISTÓN FRENO DE DISCO 		No. Lusac: 850020 Producto: PISTÓN FRENO DE DISCO 	
DIAMETRO	65.9 mm 2-19/32"	DIAMETRO	34.9 mm 1-3/8"	DIAMETRO	42.0 mm
DODGE DAKOTA 96-96		FORD TAURUS 88-91		CHRYSLER CIRRUS TOURING 99-10 CONCORDE 93-97 LE BARON 92-95 NEON 95-05 NEW YORKER 90-96 PHANTOM 90-94 SEBRING RT 97	
		CHRYSLER STRATUS 95-06 DODGE INTREPID 94-97 SHADOW GTS 89-89 SPIRIT RT 91-95		CHRYSLER VOYAGER 01-05	
No. Lusac: 850300 Producto: PISTÓN FRENO DE DISCO 		No. Lusac: 850390 Producto: PISTÓN FRENO DE DISCO 		No. Lusac: 850400 Producto: PISTÓN FRENO DE DISCO 	
DIAMETRO	55.9 mm 2-13/64"	DIAMETRO	54.0 mm 2-1/8"	DIAMETRO	52.0 mm 2-3/64"
DODGE RAM 3500 MAXI WAGON 98-02 RAM 4000 00-02 05-06 RAM VAN 3500 98-02		DODGE DURANGO 03-09 RAM 1500 01-06		CHEVROLET ASTRA INC VAGONETA 00-08	
FORD E150 ECONOLINE 95-99 E250 ECONOLINE VAN 97-99		FORD E350 ECONOLINE CLUB WAGON 95-98 F250 95-97 F350 98-04 P350 MICROBUS 96-97			
No. Lusac: 850450 Producto: PISTÓN FRENO DE DISCO 		No. Lusac: 850460 Producto: PISTÓN FRENO DE DISCO 		No. Lusac: 850700 Producto: PISTÓN FRENO DE DISCO 	
DIAMETRO	48.0 mm 1-57/64"	DIAMETRO	47.6 mm 1-7/8"	DIAMETRO	48.0 mm 1-57/64"
JEEP COMMANDER 06-10 GRAND CHEROKEE SRT8 99-10		JEEP COMMANDER 06-10 GRAND CHEROKEE SRT8 99-10		FORD EXPLORER SPORT 94-95 98-05 RANGER 04-07	

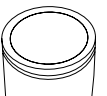

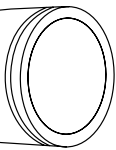

Fotografías de producto y especificaciones

No. Lusac: 850790 Producto: PISTÓN FRENO DE DISCO 		No. Lusac: 850810 Producto: PISTÓN FRENO DE DISCO 		No. Lusac: 851001 Producto: PISTÓN FRENO DE DISCO 	
DIAMETRO	52.0 mm 2-3/64"	DIAMETRO	44.4 mm 1-3/4"	DIAMETRO	63.5 mm 2-1/2"
FORD EXPEDITION 03-06		LINCOLN NAVIGATOR 03-06		FORD EXCURSION 01-05 F350 99-04	
				NISSAN MURANO 04-10	
No. Lusac: 851002 Producto: PISTÓN FRENO DE DISCO 		No. Lusac: 851003 Producto: PISTÓN FRENO DE DISCO  Imagen Disponible Próximamente		No. Lusac: 851004 Producto: PISTÓN FRENO DE DISCO  Imagen Disponible Próximamente	
DIAMETRO	45.5 mm	DIAMETRO	65.9 mm 2-19/32"	DIAMETRO	57.1 mm 2-1/4"
TOYOTA 4RUNNER 03-09 TACOMA 06-14		CHEVROLET OPTRA 06-10		CHEVROLET VECTRA 03-08	
No. Lusac: 851005 Producto: PISTÓN FRENO DE DISCO  Imagen Disponible Próximamente		No. Lusac: 851007 Producto: PISTÓN FRENO DE DISCO  Imagen Disponible Próximamente		No. Lusac: 851010 Producto: PISTÓN FRENO DE DISCO 	
DIAMETRO	48.0 mm 1-57/64"	DIAMETRO	42.8mm 1 11/16	DIAMETRO	50.8 mm 2"
VOLKSWAGEN GOL 09-14 SAVEIRO 10-14		MITSUBISHI OUTLANDER 07-10		CHEVROLET EXPRESS 2500 CARGO VAN 07-12 EXPRESS 3500 CARGO VAN 03-13	

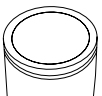

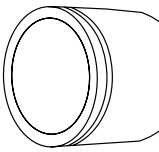



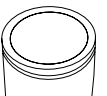

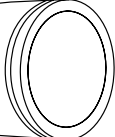



<p>No. Lusac: 851013</p> <p>Producto: PISTÓN FRENO DE DISCO</p> 		<p>No. Lusac: 851014</p> <p>Producto: PISTÓN FRENO DE DISCO</p> 		<p>No. Lusac: 851015</p> <p>Producto: PISTÓN FRENO DE DISCO</p> 	
DIAMETRO	54.0 mm 2-1/8"	DIAMETRO	54.0 mm 2-1/8"	DIAMETRO	57.1 mm 2-1/4"
<p>PONTIAC</p> <p>G5 07-09 G6 05-09</p>		<p>TOYOTA</p> <p>YARIS 06-14</p>		<p>FORD</p> <p>FOCUS LX 07</p> <p>MAZDA</p> <p>MAZDA3 06-14 MAZDA5 06-14</p>	
<p>No. Lusac: 851018</p> <p>Producto: PISTÓN FRENO DE DISCO</p> 		<p>No. Lusac: 851021</p> <p>Producto: PISTÓN FRENO DE DISCO</p> 		<p>No. Lusac: 851022</p> <p>Producto: PISTÓN FRENO DE DISCO</p> 	
DIAMETRO	57.1 mm 2-1/4"	DIAMETRO	42.0mm	DIAMETRO	54.0 mm 2-1/8"
<p>CHEVROLET</p> <p>TRACKER 03-08</p>		<p>DODGE</p> <p>CHARGER SRT8 SXT 06-07</p>		<p>FORD</p> <p>F350 05-12 F450 11-12</p>	
<p>No. Lusac: 851023</p> <p>Producto: PISTÓN FRENO DE DISCO</p> 		<p>No. Lusac: 851024</p> <p>Producto: PISTÓN FRENO DE DISCO</p> 		<p>No. Lusac: 851025</p> <p>Producto: PISTÓN FRENO DE DISCO</p> 	
DIAMETRO	60.0 mm	DIAMETRO	54.0 mm 2-1/8"	DIAMETRO	51.0 mm
<p>FORD</p> <p>F350 05-12 F450 11-12</p>		<p>FORD</p> <p>F150 XL 05-10 LOBO 05-10</p>		<p>FORD</p> <p>F150 XL 05-10 LOBO 07-10</p>	





Fotografías de producto y especificaciones

No. Lusac: 851028 Producto: PISTÓN FRENO DE DISCO  Imagen Disponible Próximamente		No. Lusac: 851029 Producto: PISTÓN FRENO DE DISCO  Imagen Disponible Próximamente		No. Lusac: 851030 Producto: PISTÓN FRENO DE DISCO  Imagen Disponible Próximamente	
DIAMETRO	45.0mm	DIAMETRO	N/D	DIAMETRO	N/D
CHEVROLET CAPTIVA SPORT 08-13		HONDA CR-V 07-11 ODYSSEY 09-10		TOYOTA CAMRY 07-11	
No. Lusac: 851031 Producto: PISTÓN FRENO DE DISCO  Imagen Disponible Próximamente		No. Lusac: 851034 Producto: PISTÓN FRENO DE DISCO  Imagen Disponible Próximamente		No. Lusac: 851042 Producto: PISTÓN FRENO DE DISCO 	
DIAMETRO	60.3 mm 2-3/8"	DIAMETRO	54.0 mm 2-1/8"	DIAMETRO	60.0 mm
TOYOTA MATRIX XR 09-10		PONTIAC G4 05-06		DODGE H100 03-09	
No. Lusac: 851046 Producto: PISTÓN FRENO DE DISCO  Imagen Disponible Próximamente		No. Lusac: 851047 Producto: PISTÓN FRENO DE DISCO 		No. Lusac: 851048 Producto: PISTÓN FRENO DE DISCO  Imagen Disponible Próximamente	
DIAMETRO	52.0mm 2-3/64"	DIAMETRO	60.0 mm	DIAMETRO	52.0mm 2-3/64"
CHEVROLET SPARK 11-12		CHEVROLET VOLKSWAGEN VECTRA 03-08 EUROVAN 06-09		NISSAN VOLKSWAGEN CABSTAR 08, 11-13 CRAFTER 08-12	



Fotografías de producto y especificaciones

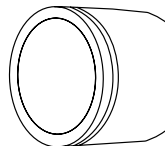



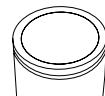

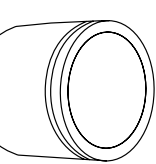



No. Lusac: 851051 Producto: PISTÓN FRENO DE DISCO 		No. Lusac: 851052 Producto: PISTÓN FRENO DE DISCO 		No. Lusac: 851053 Producto: PISTÓN FRENO DE DISCO  Imagen Disponible Próximamente	
DIAMETRO	N/D	DIAMETRO	N/D	DIAMETRO	48.0 mm 1-57/64"
CHEVROLET HHR 06-09 MALIBU 02-12		PONTIAC SOLSTICE 06-09		CADILLAC CTS 03-07 CHEVROLET COLORADO 04-08	
		GMC CANYON 07-08		FORD TRANSIT 10-13 MERCEDEZ BENZ SPRINTER 04-06	
				NISSAN CABSTAR 08-08 11-13	
No. Lusac: 851054 Producto: PISTÓN FRENO DE DISCO  Imagen Disponible Próximamente		No. Lusac: 851055 Producto: PISTÓN FRENO DE DISCO 		No. Lusac: 851056 Producto: PISTÓN FRENO DE DISCO  Imagen Disponible Próximamente	
DIAMETRO	54.0 mm 2-1/8"	DIAMETRO	60.3 mm 2-3/8"	DIAMETRO	60.0 mm
NISSAN VERSA 12-14		NISSAN VERSA 12-14		MITSUBISHI ECLIPSE GT 06-12 GALANT ES, GTS, INC, RALLIART 03-09	
		MITSUBISHI OUTLANDER 04-06		FORD F350 13-14 F450 13-14	
No. Lusac: 851060 Producto: PISTÓN FRENO DE DISCO  Imagen Disponible Próximamente		No. Lusac: 851067 Producto: PISTÓN FRENO DE DISCO 		No. Lusac: 851070 Producto: PISTÓN FRENO DE DISCO 	
DIAMETRO	57.1 mm 2-1/4"	DIAMETRO	54.0 mm 2-1/8"	DIAMETRO	57.1 mm 2-1/4"
FORD FUSION SE 08-09		DODGE ATTITUDE 06-11		CADILLAC DTS 06-08 CHEVROLET EXPRESS 2500 CARGO VAN 07-13 EXPRESS 3500 CARGO VAN 01-11	
				HUMMER H2 SUT 05-09	









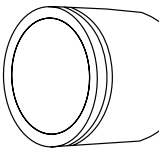

Fotografías de producto y especificaciones

No. Lusac: 851075 Producto: PISTÓN FRENO DE DISCO 		No. Lusac: 851076 Producto: PISTÓN FRENO DE DISCO 		No. Lusac: 851110 Producto: PISTÓN FRENO DE DISCO 	
DIAMETRO	66.7 mm 2-5/8"	DIAMETRO	42.8 mm 1-11/16"	DIAMETRO	44.4 mm 1-3/4"
TOYOTA HIACE 06-13		TOYOTA HILUX 04-10		CHEVROLET EXPRESS 1500 CARGO VAN 07-13 EXPRESS 2500 CARGO VAN 04-06 EXPRESS 3500 CARGO VAN 03-11 SONORA 00-06 SUBURBAN 1500 2500 04-06	
No. Lusac: 851330 Producto: PISTÓN FRENO DE DISCO 		No. Lusac: 851340 Producto: PISTÓN FRENO DE DISCO 		No. Lusac: 851470 Producto: PISTÓN FRENO DE DISCO 	
DIAMETRO	57.1 mm 2-1/4"	DIAMETRO	38.1 mm 1-1/2"	DIAMETRO	34.9 mm 1-3/8"
CHRYSLER 200 12-14 CIRRUS TOURING LIMITED 06-10		JEEP COMPASS 07-14 PATRIOT 07-14		HONDA CR-V 02-09	
DODGE AVENGER 08-14 CALIBER SRT4 08-09 07-12		TOYOTA COROLLA S 03-11 MATRIX XR 03-08		NISSAN ALTIMA 02-12	
HONDA CR-V 02-09		CHRYSLER 200 12-14 CIRRUS TOURING LIMITED 06-10		MITSUBISHI ECLIPSE GT 06-12 LANCER DE, ES DE, EVOLUTION IX RALLIART 05-09	
MITSUBISHI ECLIPSE GT 06-12 LANCER DE, ES DE, EVOLUTION IX RALLIART 05-09		NISSAN ALTIMA 02-12		MITSUBISHI MAXIMA SE 02-08 X-TRAIL 02-10	
No. Lusac: 853220 Producto: PISTÓN FRENO DE DISCO 		No. Lusac: 853260 Producto: PISTÓN FRENO DE DISCO 		No. Lusac: 853271 Producto: PISTÓN FRENO DE DISCO 	
DIAMETRO	63.5 mm 2-1/2"	DIAMETRO	50.8 mm 2"	DIAMETRO	32.1 mm 1-17/64"
HONDA PILOT 03-08 SIENNA 04-10		TOYOTA YARIS HATCH BACK 04-07		TOYOTA RAV4 04-13	
TOYOTA CAMRY LE 02-08 RAV4 06-13		TOYOTA YARIS HATCH BACK 04-07		TOYOTA RAV4 04-13	







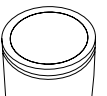

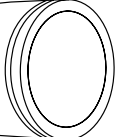
No. Lusac: 853940 Producto: PISTÓN FRENO DE DISCO 		No. Lusac: 854790 Producto: PISTÓN FRENO DE DISCO 		No. Lusac: DPS85127 Producto: PISTÓN FRENO DE DISCO 	
DIAMETRO	60.3 mm 2-3/8"	DIAMETRO	65.9 mm 2-19/32"	DIAMETRO	N/D
CHEVROLET MALIBU 97-05 PONTIAC GRAND AM 99-05		TOYOTA RAV4 04-05		CHEVROLET SILVERADO 3500 01-06	
				FORD MONDEO SPORT XLS 03-04	
No. Lusac: DPS85169 Producto: PISTÓN FRENO DE DISCO 		No. Lusac: DPS-85199 Producto: PISTÓN FRENO DE DISCO 		No. Lusac: DPS85468 Producto: PISTÓN FRENO DE DISCO 	
DIAMETRO	N/D	DIAMETRO	N/D	DIAMETRO	N/D
FORD COUGAR 90-95 TAURUS 90-91		LINCOLN CONTINENTAL 97-99 MARK VIII 94-96		NISSAN 300ZX 91-96	
				MITSUBISHI ECLIPSE GT 03-05	
No. Lusac: DPS85840 Producto: PISTÓN FRENO DE DISCO 					
DIAMETRO	N/D				
FORD ESCORT GT VAGONETA 94-99					



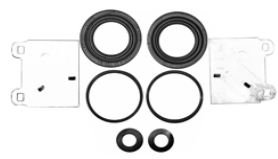









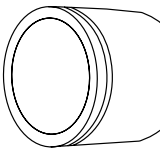

Fotografías de producto y especificaciones

No. Lusac: 124		No. Lusac: 126		No. Lusac: 127	
Producto: REP. FRENO DE DISCO		Producto: REP. FRENO DE DISCO		Producto: REP. FRENO DE DISCO	
					
DIAMETRO	48.0 mm 1-57/64"	DIAMETRO	54.0 mm 2-1/8"	DIAMETRO	40.0 mm
CHEVROLET CHEVY C2 JOY, MONZA, POP, VAGONETA SWING 95-12 CORSAR VARIANT 84-88 CHEVY PICKUP 99-03 DERBY 95-00 RENAULT SANDERO 10-12 GOLF 87-99 VOLKSWAGEN JETTA A2 87-92 CABRIO A3 96-99		VOLKSWAGEN COMBI 90-01 PANEL 93-93		VOLKSWAGEN SEDAN 95-04	
No. Lusac: 641		No. Lusac: 642		No. Lusac: 643	
Producto: REP. FRENO DE DISCO		Producto: REP. FRENO DE DISCO		Producto: REP. FRENO DE DISCO	
					
DIAMETRO	48.0 mm 1-57/64"	DIAMETRO	60.3 mm 2-3/8"	DIAMETRO	54.0 mm 2-1/8"
NISSAN HIKARI 88-92 TSURU II III GS 88-15 SENTRA 92-92 TSUBAME 93-99 01-04		CHEVROLET HHR 06-09 NISSAN ICHI VAN 87-94 PICKUP NISSAN DOBLE CABINA 82-89 MITSUBISHI ECLIPSE GT 06-12 GALANT ES GTS INC, RALLIART, 03-09 PONTIAC SOLSTICE 06-09		MITSUBISHI LANCER ES DE, RALLIART 04-10	



Fotografías de producto y especificaciones





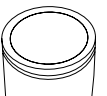

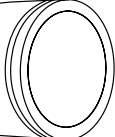



No. Lusac: 1449 Producto: REP. FRENO DE DISCO 		No. Lusac: 1458 Producto: REP. FRENO DE DISCO 		No. Lusac: 1473 Producto: REP. FRENO DE DISCO 	
DIAMETRO	54.0 mm 2-1/8"	DIAMETRO	57.1 mm 2-1/4"	DIAMETRO	66.0 mm
CHEVROLET MERIVA 04-08		RENAULT MEGANE II, SPORT 05-07, 01-02		HONDA ACCORD 08-12	
FIAT PALIO 04-11		SEAT LEON 01-09		SUZUKI GRAND VITARA 06-11	
FORD COURIER PICKUP 01-10 ECOSPORT 04-10 FIESTA 07-14 IKON 02-07 KA 01-08 PEUGEOT PARTNER 04-09		NISSAN 240SX 98-98		JEEP CHEROKEE SPORT 94, 98-01 CJ7 84-86 GRAND CHEROKEE 93-94 WRANGLER 93-95, 97-02	
No. Lusac: 1562 Producto: REP. FRENO DE DISCO 		No. Lusac: 1565 Producto: REP. FRENO DE DISCO 		No. Lusac: 1569 Producto: REP. FRENO DE DISCO 	
DIAMETRO	48.0 mm 1-57/64"	DIAMETRO	66.7 mm 2-5/8"	DIAMETRO	39.7 mm 1-9/16"
CHEVROLET TRACKER 98-02		FORD AEROSTAR 91-95 EXPLORER 91-94		CHEVROLET CORVETTE 91-96	
No. Lusac: 1595 Producto: REP. FRENO DE DISCO 		No. Lusac: 1668 Producto: REP. FRENO DE DISCO 		No. Lusac: 1800 Producto: REP. FRENO DE DISCO 	
DIAMETRO	54.0 mm 2-1/8"	DIAMETRO	42.8 mm 1-11/16"	DIAMETRO	42.8 mm 1-11/16"
HONDA CIVIC 97-06		NISSAN FRONTIER D22 09-11 PATHFINDER 97-98		INFINITI Q45 94-96	
		PICKUP NISSAN NP300 80-97, 09-14			





Fotografías de producto y especificaciones

No. Lusac: 1837 Producto: REP. FRENO DE DISCO 		No. Lusac: 1838 Producto: REP. FRENO DE DISCO 		No. Lusac: 1966 Producto: REP. FRENO DE DISCO 	
DIAMETRO	65.9 mm 2-19/32"	DIAMETRO	73.0 mm 2-7/8"	DIAMETRO	59.5 mm 2-11/32"
FORD MUSTANG GT 98		FORD E150 ECONLINE WAGON VAN 95-07 F150 86-89 92-96 E250 ECONLINE VAN 99-07 E350 ECONLINE CLUB WAGON 97-98		FORD F450 97-02	
No. Lusac: 1967 Producto: REP. FRENO DE DISCO 		No. Lusac: 1973 Producto: REP. FRENO DE DISCO 		No. Lusac: 2005 Producto: REP. FRENO DE DISCO 	
DIAMETRO	45.0 mm	DIAMETRO	63.5 mm 2-1/2"	DIAMETRO	74.6 mm 2-15/16"
FORD TAURUS 90-91 THUNDERBIRD 90-92		CHEVROLET C1500 88-91 C2500 89-91		CHEVROLET C1500 94-99 SUBURBAN 1500, 2500 00-03 00-04 DODGE C2500 CHEYENNE 95-99 92-99 EXPRESS 1500 CARGO VAN 98-06 EXPRESS 2500 98-99 SILVERADO 1500 00-01 03-06 RAM 1500 94-00 RAM 2500 94-00	
No. Lusac: 2020 Producto: REP. FRENO DE DISCO 		No. Lusac: 2033 Producto: REP. FRENO DE DISCO 		No. Lusac: 2038 Producto: REP. FRENO DE DISCO 	
DIAMETRO	54.0 mm 2-1/8"	DIAMETRO	86.1 mm 3-25/64"	DIAMETRO	69.8 mm 2-3/4"
DODGE VERNA 04-06		NISSAN LUCINO GSR 96-00		DODGE DURANGO 98-02	
		DODGE RAM 3500 94-99 RAM 4000 95-97 99		DODGE RAM SRT-10 05-06	

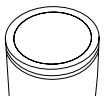

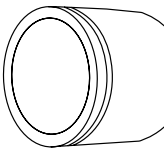



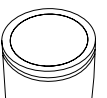

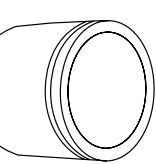



No. Lusac: 2040 Producto: REP. FRENO DE DISCO		No. Lusac: 2045 Producto: REP. FRENO DE DISCO		No. Lusac: 2048 Producto: REP. FRENO DE DISCO	
DIAMETRO	52.0 mm 2-3/64"	DIAMETRO	48.0 mm 1-57/64"	DIAMETRO	34.0 mm
CHEVROLET ASTRA 07-08		JEEP COMMANDER 06-10 GRAND CHEROKEE 99-05		CHEVROLET ASTRA INC VAGONETA 00-01	
No. Lusac: 2070 Producto: REP. FRENO DE DISCO		No. Lusac: 2079 Producto: REP. FRENO DE DISCO		No. Lusac: 2103 Producto: REP. FRENO DE DISCO	
DIAMETRO	48.0 mm 1-57/64"	DIAMETRO	52.0 mm 2-3/64"	DIAMETRO	38.1 mm 1-1/2"
FORD EXPLORER EDDIE BAUER SPORT 94-95 98-05		LINCOLN NAVIGATOR 03-06		AUDI VOLKSWAGEN A3 98-14 BEETLE 06-10 A4 AVANT 97-11 SEAT IBIZA 01-02	
No. Lusac: 2105 Producto: REP. FRENO DE DISCO		No. Lusac: 2107 Producto: REP. FRENO DE DISCO		No. Lusac: 2110 Producto: REP. FRENO DE DISCO	
DIAMETRO	30.1 mm 1-3/16"	DIAMETRO	57.1 mm 2-1/4"	DIAMETRO	80.2 mm 3-5/32"
HONDA ACCORD 07		CADILLAC HUMMER DTS 06-08 H2 SUT SUV 05-09 CHEVROLET EXPRESS 3500 04-05		CHEVROLET C3500 89-89 91-91 EXPRESS 3500 CARGO VAN 97-00	









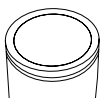

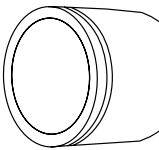



Fotografías de producto y especificaciones

No. Lusac: 2119 Producto: REP. FRENO DE DISCO 		No. Lusac: 2135 Producto: REP. FRENO DE DISCO 		No. Lusac: 2148 Producto: REP. FRENO DE DISCO 	
DIAMETRO	45.0 mm	DIAMETRO	64.3 mm 2-17/32"	DIAMETRO	46.4 mm 1-53/64"
CADILLAC ESCALADE 04-06		CHEVROLET SONORA 00-06		HONDA ODYSSEY 00-08	
NISSAN XTERRA 00-07		No. Lusac: 2152 Producto: REP. FRENO DE DISCO 		No. Lusac: 2154 Producto: REP. FRENO DE DISCO 	
NISSAN XTERRA 00-07		No. Lusac: 2159 Producto: REP. FRENO DE DISCO 			
DIAMETRO	64.0 mm	DIAMETRO	55.9 mm 2-13/64"	DIAMETRO	50.8 mm 2"
CHRYSLER GRAND VOYAGER 01-02		DODGE RAM 3500 MAXI WAGON 98-02 RAM VAN 3500 98-02 RAM 4000 00-02 05-06		CADILLAC ESCALADE ESV 13-14 SILVERADO 2500 CHEYENNE 02, 07-10 CHEVROLET C2500 96-99 SUBURBAN 2500 05-06 SILVERADO 1500 00-01 03-06 TAHOE 07-14	
No. Lusac: 2215 Producto: REP. FRENO DE DISCO 		No. Lusac: 2216 Producto: REP. FRENO DE DISCO 		No. Lusac: 2225 Producto: REP. FRENO DE DISCO 	
DIAMETRO	48.0 mm 1-57/64"	DIAMETRO	44.4 mm 1-3/4"	DIAMETRO	38.1 mm 1-1/2"
NISSAN APRIO 08, 10 PLATINA 02-10		RENAULT CLIO ENERGY EXPRESSION SPORT 02-10 EURO CLIO AUTENTIQUE 07		NISSAN PATHFINDER 99-04 X-TRAIL 02-10	
JAGUAR S TYPE, TYPE R 03-08, 01-08 X TYPE 02-08		LINCOLN LS 00-06			







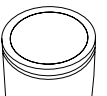

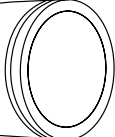



<p>No. Lusac: 2261 Producto: REP. FRENO DE DISCO</p> 		<p>No. Lusac: 2275 Producto: REP. FRENO DE DISCO</p> 		<p>No. Lusac: 2325 Producto: REP. FRENO DE DISCO</p> 	
DIAMETRO	57.1 mm 2-1/4"	DIAMETRO	45.0 mm	DIAMETRO	30.1 mm 1-3/16"
<p>CADILLAC CATERA 97-01</p>		<p>CHEVROLET CAMARO Z28 98-02 FORD MUSTANG GT 98-04</p>		<p>PONTIAC FIREBIRD TRANS AM 98-01</p> <p>PEUGEOT 206 INC XR, XT 07</p> <p>RENAULT MEGANE II 07</p>	
<p>No. Lusac: 2390 Producto: REP. FRENO DE DISCO</p> 		<p>No. Lusac: 2394 Producto: REP. FRENO DE DISCO</p> 		<p>No. Lusac: 2472 Producto: REP. FRENO DE DISCO</p> 	
DIAMETRO	48.0 mm 1-57/64"	DIAMETRO	60.3 mm 2-3/8"	DIAMETRO	57.1 mm 2-1/4"
<p>CHEVROLET CORSA 02-08 TORNADO 04-11</p>		<p>CHEVROLET MALIBU 97-01</p>		<p>CHEVROLET ZAFIRA 02-06</p> <p>NISSAN SENTRA SE-R 02-12</p>	
<p>No. Lusac: 2473 Producto: REP. FRENO DE DISCO</p> 		<p>No. Lusac: 2475 Producto: REP. FRENO DE DISCO</p> 		<p>No. Lusac: 2477 Producto: REP. FRENO DE DISCO</p> 	
DIAMETRO	54.0 mm 2-1/8"	DIAMETRO	46.0 mm 1-13/16"	DIAMETRO	48.0 mm 1-57/64"
<p>CHRYSLER ASPEN 07-09 DODGE DURANGO 03-09 RAM 1500 ST 09-12</p> <p>RAM 2500 11-12 RAM VAN 1500 02-03 RAM WAGON 1500 02-03</p>		<p>CADILLAC ESCALADE 02-03 CHEVROLET BLAZER 98-01</p> <p>TRAILBLAZER 02-06</p>		<p>FORD EXPLORER EDDIE BAUER SPORT 94-05 LINCOLN AVIATOR 03-05</p> <p>TOWN CAR 01-02</p>	











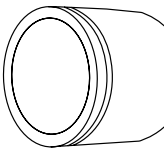



Fotografías de producto y especificaciones

No. Lusac: 2484 Producto: REP. FRENO DE DISCO 		No. Lusac: 2486 Producto: REP. FRENO DE DISCO 		No. Lusac: 2489 Producto: REP. FRENO DE DISCO 	
DIAMETRO	60.3 mm 2-3/8"	DIAMETRO	47.6 mm 1-7/8"	DIAMETRO	45.0 mm
CHEVROLET LUV 97-05		NISSAN QUEST 04-09 URVAN CARGA 02-11		DODGE RAM 4000 05-08 RAM MEGA CAB LARAMIE 06-08	
No. Lusac: 2492 Producto: REP. FRENO DE DISCO 		No. Lusac: 2493 Producto: REP. FRENO DE DISCO 		No. Lusac: 2496 Producto: REP. FRENO DE DISCO 	
DIAMETRO	44.0 mm	DIAMETRO	38.1 mm 1-1/2"	DIAMETRO	48.0 mm 1-57/64"
FORD WINDSTAR 99-03		PONTIAC GRAND AM 99-05		CHEVROLET MATIZ 04-11	
No. Lusac: 2500 Producto: REP. FRENO DE DISCO 		No. Lusac: 2725 Producto: REP. FRENO DE DISCO 		No. Lusac: 2730 Producto: REP. FRENO DE DISCO 	
DIAMETRO	54.0 mm 2-1/8"	DIAMETRO	50.8 mm 2"	DIAMETRO	55.6 mm 2-3/16"
PEUGEOT 206 INC, XR, XT 07, 09-10 TRAFFIC 08-09		DODGE ATOS 01-12		FORD F250 92-94	
RENAULT KANGOO EXPRESS 04-09					





No. Lusac: 2735 Producto: REP. FRENO DE DISCO		No. Lusac: 2746 Producto: REP. FRENO DE DISCO		No. Lusac: 2769 Producto: REP. FRENO DE DISCO	
					
DIAMETRO	30.1 mm 1-3/16"	DIAMETRO	39.7 mm 1-9/16"	DIAMETRO	47.6 mm 1-7/8"
FORD ESCORT GT LX VAGONETA 94-01		CHEVROLET CAMARO 95-97		PONTIAC FIREBIRD TRANS AM 94-97	
No. Lusac: 2776 Producto: REP. FRENO DE DISCO		No. Lusac: 2783 Producto: REP. FRENO DE DISCO		No. Lusac: 2797 Producto: REP. FRENO DE DISCO	
					
DIAMETRO	54.0 mm 2-1/8"	DIAMETRO	38.1 mm 1-1/2"	DIAMETRO	54.0 mm 2-1/8"
FORD ESCORT VAGONETA 94-96		INFINITI Q45 94-96		LINCOLN CONTINENTAL 97-99	
No. Lusac: 2810 Producto: REP. FRENO DE DISCO		No. Lusac: 2813 Producto: REP. FRENO DE DISCO		No. Lusac: 2814 Producto: REP. FRENO DE DISCO	
					
DIAMETRO	54.0 mm 2-1/8"	DIAMETRO	48.0 mm 1-57/64"	DIAMETRO	48.0 mm 1-57/64"
AUDI S3 11-12		VOLKSWAGEN BEETLE 11-14 GOLF A4 06-07 JETTA CLASICO 14		MINI COOPER 02-06	
FORD FOCUS EUROPA LX ZX3 00-07		LINCOLN NAVIGATOR 03-06		FORD WINDSTAR 99-03	

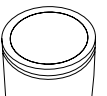

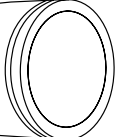





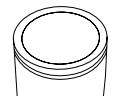

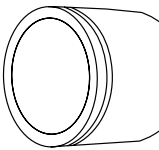



Fotografías de producto y especificaciones

No. Lusac: 2815 Producto: REP. FRENO DE DISCO		No. Lusac: 2817 Producto: REP. FRENO DE DISCO		No. Lusac: 2820 Producto: REP. FRENO DE DISCO	
DIAMETRO	54.0 mm 2-1/8"	DIAMETRO	48.0 mm 1-57/64"	DIAMETRO	57.1 mm 2-1/4"
FORD EXCURSION 01-05 F350 SUPER DUTY 99-04 F250 SUPER DUTY TRITON 99-04		FORD LINCOLN F150 XL 00-04 TOWN CAR 98-07 GRAND MARQUIS 98-04		FORD MONDEO CORE GHIA TREND 01-07	
No. Lusac: 2823 Producto: REP. FRENO DE DISCO		No. Lusac: 2826 Producto: REP. FRENO DE DISCO		No. Lusac: 2827 Producto: REP. FRENO DE DISCO	
DIAMETRO	38.1 mm 1-1/2"	DIAMETRO	50.8 mm 2"	DIAMETRO	50.8 mm 2"
FORD MUSTANG COBRA GT 97-04		FORD LINCOLN EXPEDITION 97-02 NAVIGATOR 98-02 F250 XL 97-98		FORD LINCOLN EXPEDITION 97-02 BLACKWOOD 03 F150, XL 04-04 00-01 NAVIGATOR 98-02 F250 XL 97-99 TOWN CAR 03-06 LOBO 01-03	
No. Lusac: 2844 Producto: REP. FRENO DE DISCO		No. Lusac: 2845 Producto: REP. FRENO DE DISCO		No. Lusac: 2857 Producto: REP. FRENO DE DISCO	
DIAMETRO	60.0 mm	DIAMETRO	54.0 mm 2-1/8"	DIAMETRO	46.0 mm 1-13/16"
FORD MERCURY CONTOUR 96-00 MARINER 05-09 ESCAPE 01-10 MYSTIQUE 95-00		CHRYSLER PLYMOUTH CIRRUS CONVERTIBLE, COUPE 99-05, 96-00 BREEZE 96 SEBRING 97-97 STRATUS R-14, R-15 95-00, 96-97		CHEVROLET EQUINOX 05-08 RANGER 96-03 08-11 FORD EXPLORER EDDIE BAUER 95-02	







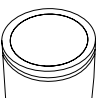

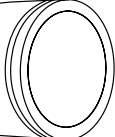



<p>No. Lusac: 2885</p> <p>Producto: REP. FRENO DE DISCO</p> 		<p>No. Lusac: 2901</p> <p>Producto: REP. FRENO DE DISCO</p> 		<p>No. Lusac: 10824</p> <p>Producto: REP. FRENO DE DISCO</p> 	
DIAMETRO	55.9 mm 2-13/64"	DIAMETRO	48.0 mm 1-57/64"	DIAMETRO	60.0 mm
<p>FORD</p> <p>E150 ECONLINE WAGON VAN 95-99 F350 98-98 98-98</p> <p>E250 ECONLINE VAN 97-99 P350 MICROBUS 96-97</p> <p>E350 ECONLINE CLUB WAGON VAN 97-98</p> <p>F250 95-97</p>		<p>VOLKSWAGEN</p> <p>GOL 09-14 SAVEIRO 10-14</p> <p>POINTER INC CITY, PICKUP, VAGONETA TRENDLINE 99-07</p>		<p>FORD</p> <p>F350 13-14</p>	
<p>No. Lusac: 20020</p> <p>Producto: REP. FRENO DE DISCO</p> 		<p>No. Lusac: 20460</p> <p>Producto: REP. FRENO DE DISCO</p> 		<p>No. Lusac: 20930</p> <p>Producto: REP. FRENO DE DISCO</p> 	
DIAMETRO	42.0 mm	DIAMETRO	47.6 mm 1-7/8"	DIAMETRO	59.5 mm 2-11/32"
<p>CHRYSLER</p> <p>VOYAGER 01-08</p>		<p>JEEP</p> <p>COMMANDER 06-10</p> <p>GRAND CHEROKEE 99-10</p>		<p>FORD</p> <p>F450 03-10</p> <p>F550 01-14</p>	
<p>No. Lusac: 21001</p> <p>Producto: REP. FRENO DE DISCO</p> 		<p>No. Lusac: 21002</p> <p>Producto: REP. FRENO DE DISCO</p> 		<p>No. Lusac: 21003</p> <p>Producto: REP. FRENO DE DISCO</p> 	
DIAMETRO	63.5 mm 2-1/2"	DIAMETRO	45.5 mm	DIAMETRO	31 mm 1-17/64"
<p>NISSAN</p> <p>MURANO 04-10</p>		<p>TOYOTA</p> <p>TACOMA SR5 TRD SPORT 06-14</p>		<p>CHEVROLET</p> <p>OPTRA 06-10</p>	









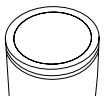

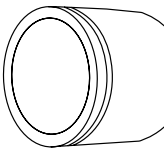



Fotografías de producto y especificaciones

No. Lusac: 21004 Producto: REP. FRENO DE DISCO 		No. Lusac: 21005 Producto: REP. FRENO DE DISCO 		No. Lusac: 21007 Producto: REP. FRENO DE DISCO 	
DIAMETRO	57.1 mm 2-1/4"	DIAMETRO	34.1 mm 1-11/32"	DIAMETRO	42.8 mm 1-11/16"
CHEVROLET VECTRA 03-08		FORD FUSION 06-12		MITSUBISHI MONTERO 03-09 OUTLANDER 07-10	
No. Lusac: 21010 Producto: REP. FRENO DE DISCO 		No. Lusac: 21013 Producto: REP. FRENO DE DISCO 		No. Lusac: 21014 Producto: REP. FRENO DE DISCO 	
DIAMETRO	50.8 mm 2"	DIAMETRO	54.0 mm 2-1/8"	DIAMETRO	54.0 mm 2-1/8"
CHEVROLET EXPRESS 3500 CARGO VAN 03-13		PONTIAC G5 07-09 G6 05-09		TOYOTA YARIS 06-14	
No. Lusac: 21015 Producto: REP. FRENO DE DISCO 		No. Lusac: 21016 Producto: REP. FRENO DE DISCO 		No. Lusac: 21017 Producto: REP. FRENO DE DISCO 	
DIAMETRO	57.1 mm 2-1/4"	DIAMETRO	57.1 mm 2-1/4"	DIAMETRO	54.0 mm 2-1/8"
MAZDA MAZDA3 HB S SEDAN I 06-14 MAZDA5 06-12		VOLKSWAGEN SHARAN 02-08		ISUZU ELF-300 08-09 ELF-400 07-11 ELF-450 07-09	
				NISSAN TIIDA 07-14	







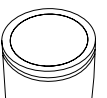

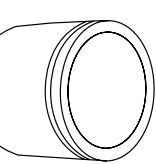



<p>No. Lusac: 21018</p> <p>Producto: REP. FRENO DE DISCO</p> 		<p>No. Lusac: 21019</p> <p>Producto: REP. FRENO DE DISCO</p> 		<p>No. Lusac: 21020</p> <p>Producto: REP. FRENO DE DISCO</p> 			
DIAMETRO	60.0 mm	DIAMETRO	65.9 mm 2-19/32"	DIAMETRO	48.0 mm 1-57/64"		
<p>VOLKSWAGEN</p> <p>EUROVAN 06-09</p>		<p>TOYOTA</p> <p>RAV4 06-10</p>		<p>CHEVROLET</p> <p>BLAZER 98-01</p>		<p>FORD</p> <p>EXPLORER SPORT TRAC 07-10</p>	
<p>No. Lusac: 21021</p> <p>Producto: REP. FRENO DE DISCO</p> 		<p>No. Lusac: 21022</p> <p>Producto: REP. FRENO DE DISCO</p> 		<p>No. Lusac: 21023</p> <p>Producto: REP. FRENO DE DISCO</p> 			
DIAMETRO	42.0 mm	DIAMETRO	54.0 mm 2-1/8"	DIAMETRO	60.0 mm		
<p>DODGE</p> <p>CHARGER, SRT8 SXT 07-10 06-07</p>		<p>TOYOTA</p> <p>TACOMA 06-14</p>		<p>FORD</p> <p>F350 SUPER DUTY FX4, KING RANCH, LARIANT, XL XLT 05-12</p> <p>F450 SUPER DUTY 11-12</p>			
<p>No. Lusac: 21024</p> <p>Producto: REP. FRENO DE DISCO</p> 		<p>No. Lusac: 21025</p> <p>Producto: REP. FRENO DE DISCO</p> 		<p>No. Lusac: 21028</p> <p>Producto: REP. FRENO DE DISCO</p> 			
DIAMETRO	54.0 mm 2-1/8"	DIAMETRO	51.0 mm	DIAMETRO	45.5 mm		
<p>FORD</p> <p>F150 XL 05-10</p> <p>LOBO 05-10</p>		<p>FORD</p> <p>F150 XL 05-10</p> <p>LOBO 07-10</p>		<p>TOYOTA</p> <p>4RUNNER 03-09</p>			









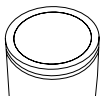

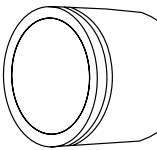

Fotografías de producto y especificaciones

No. Lusac: 21030 Producto: REP. FRENO DE DISCO 		No. Lusac: 21031 Producto: REP. FRENO DE DISCO 		No. Lusac: 21034 Producto: REP. FRENO DE DISCO 	
DIAMETRO	63.5 mm 2-1/2"	DIAMETRO	60.3 mm 2-3/8"	DIAMETRO	54.0 mm 2-1/8"
TOYOTA CAMRY LE XLE 07-12 07-12		TOYOTA MATRIX 09-10		PONTIAC G4 05-06	
No. Lusac: 21035 Producto: REP. FRENO DE DISCO 		No. Lusac: 21036 Producto: REP. FRENO DE DISCO 		No. Lusac: 21041 Producto: REP. FRENO DE DISCO 	
DIAMETRO	50.8 mm 2"	DIAMETRO	60.3 mm 2-3/8"	DIAMETRO	45.5 mm
ISUZU ELF-200 09-12		SUZUKI GRAND VITARA 06-12		HONDA MITSUBISHI CR-V 10-11 ENDEAVOR LIMITED 4-08, 11	
No. Lusac: 21042 Producto: REP. FRENO DE DISCO 		No. Lusac: 21045 Producto: REP. FRENO DE DISCO 		No. Lusac: 21046 Producto: REP. FRENO DE DISCO 	
DIAMETRO	60.0 mm	DIAMETRO	50.8mm 2"	DIAMETRO	52.0mm 2-3/64"
DODGE H100 03-09		CHEVROLET GMC SILVERADO 2500 07-10 YUKON 07-14 SUBURBAN 2500 11-13 TAHOE 07-14		CHEVROLET SPARK 11-12	

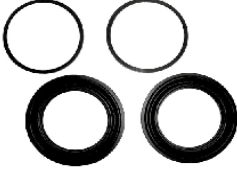





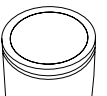

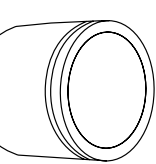

<p>No. Lusac: 21047 Producto: REP. FRENO DE DISCO</p> 		<p>No. Lusac: 21048 Producto: REP. FRENO DE DISCO</p> 		<p>No. Lusac: 21049 Producto: REP. FRENO DE DISCO</p> 	
DIAMETRO	60.0 mm	DIAMETRO	52.0mm 2-3/64"	DIAMETRO	48.0 mm 1-57/64"
<p>CHEVROLET VECTRA 03-08</p>		<p>NISSAN CABSTAR 08, 11-13</p>		<p>NISSAN CABSTAR 08, 11-13</p>	
<p>No. Lusac: 21051 Producto: REP. FRENO DE DISCO</p> 		<p>No. Lusac: 21052 Producto: REP. FRENO DE DISCO</p> 		<p>No. Lusac: 21053 Producto: REP. FRENO DE DISCO</p> 	
DIAMETRO	63.5 mm 2-1/2"	DIAMETRO	45.5 mm	DIAMETRO	48.0 mm 1-57/64"
<p>TOYOTA SIENNA CE LE XLE 04-10 SOLARA 05-06</p>		<p>CHEVROLET GMC COLORADO 04-08 CANYON 07-08</p>		<p>FORD TRANSIT 10-13</p>	
<p>No. Lusac: 21054 Producto: REP. FRENO DE DISCO</p> 		<p>No. Lusac: 21058 Producto: REP. FRENO DE DISCO</p> 		<p>No. Lusac: 21059 Producto: REP. FRENO DE DISCO</p> 	
DIAMETRO	54.0 mm 2-1/8"	DIAMETRO	54.0 mm 2-1/8"	DIAMETRO	60.0 mm
<p>NISSAN VERSA 12-14</p>		<p>DODGE DURANGO 07-09</p>		<p>FORD F350 SUPER DUTY XT 12-13</p>	



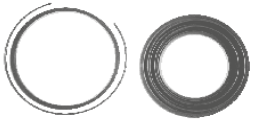
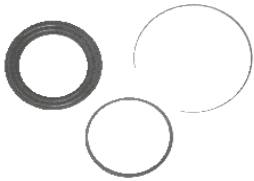
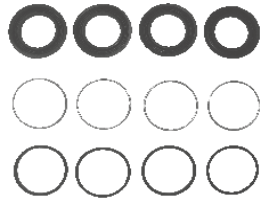





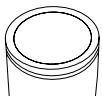

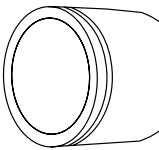



Fotografías de producto y especificaciones

No. Lusac: 21067 Producto: REP. FRENO DE DISCO 		No. Lusac: 21068 Producto: REP. FRENO DE DISCO 		No. Lusac: 21069 Producto: REP. FRENO DE DISCO 	
DIAMETRO	54.0 mm 2-1/8"	DIAMETRO	54.0 mm 2-1/8"	DIAMETRO	38.1 mm 1-1/2"
DODGE ATTITUDE 06-11		VOLKSWAGEN POINTER VAGONETA 98		CHEVROLET AVEO 08-14 OPTRA 06-10	
				CHEVROLET MALIBU 04-12 G5 GT 07-09 PONTIAC G4 GT 06 G6 GT Y GTP 05-09	
No. Lusac: 21072 Producto: REP. FRENO DE DISCO 		No. Lusac: 21075 Producto: REP. FRENO DE DISCO 		No. Lusac: 21076 Producto: REP. FRENO DE DISCO 	
DIAMETRO	63.5 mm 2-1/2"	DIAMETRO	66.7 mm 2-5/8"	DIAMETRO	42.8 mm 1-11/16"
HONDA PILOT EXL LX 03-08		TOYOTA HIACE 06-13		TOYOTA HILUX 04-10	
No. Lusac: 21078 Producto: REP. FRENO DE DISCO 		No. Lusac: 21080 Producto: REP. FRENO DE DISCO 		No. Lusac: 21160 Producto: REP. FRENO DE DISCO 	
DIAMETRO	57.1 mm 2-1/4"	DIAMETRO	66.0 mm	DIAMETRO	64.0 mm
CHRYSLER 200 12-14		CHRYSLER TOWN & COUNTRY 01-07 VOYAGER 01-08		PONTIAC AZTEK 01-05	
DODGE AVENGER 08-14 CALIBER SRT4 08-09, 07-12					
JEEP COMPASS 07-14 PATRIOT 07-14					







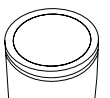

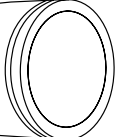



<p>No. Lusac: 21310 Producto: REP. FRENO DE DISCO</p> 		<p>No. Lusac: 21330 Producto: REP. FRENO DE DISCO</p> 		<p>No. Lusac: 21341 Producto: REP. FRENO DE DISCO</p> 	
DIAMETRO	33.7mm	DIAMETRO	57.1 mm 2-1/4"	DIAMETRO	38.1 mm 1-1/2"
<p>HONDA ACCORD 98-02</p>		<p>TOYOTA COROLLA S 05-08 03-11 MATRIX XR 03-08</p>		<p>HONDA CR-V 02-06</p>	
<p>No. Lusac: 21470 Producto: REP. FRENO DE DISCO</p> 		<p>No. Lusac: 21640 Producto: REP. FRENO DE DISCO</p> 		<p>No. Lusac: 21980 Producto: REP. FRENO DE DISCO</p> 	
DIAMETRO	34.9 mm 1-3/8"	DIAMETRO	38.1 mm 1-1/2"	DIAMETRO	38.1 mm 1-1/2"
<p>NISSAN X-TRAIL 02-10</p>		<p>NISSAN ALMERA 01-05</p>		<p>TOYOTA MATRIX 09-10</p>	
<p>No. Lusac: 21981 Producto: REP. FRENO DE DISCO</p> 		<p>No. Lusac: 21989 Producto: REP. FRENO DE DISCO</p> 		<p>No. Lusac: 21994 Producto: REP. FRENO DE DISCO</p> 	
DIAMETRO	57.1 mm 2-1/4"	DIAMETRO	45.0mm	DIAMETRO	54.0 mm 2-1/8"
<p>VOLKSWAGEN PASSAT 06-10</p>		<p>CHEVROLET CAPTIVA SPORT 08-13</p>		<p>NISSAN MICRA 05-07</p>	





Fotografías de producto y especificaciones

No. Lusac: 21995 Producto: REP. FRENO DE DISCO 		No. Lusac: 21996 Producto: REP. FRENO DE DISCO 		No. Lusac: 21998 Producto: REP. FRENO DE DISCO 	
DIAMETRO	54.0 mm 2-1/8"	DIAMETRO	57.1 mm 2-1/4"	DIAMETRO	66.0 mm
CHEVROLET VECTRA 03-08 FORD FOCUS EUROPA SVT 07-10 02-03		MAZDA MAZDA3 SEDAN I 06-12 MAZDA5 06-12		FORD FOCUS LX 07-07	
				CHRYSLER TOWN & COUNTRY 08-12 DODGE JOURNEY 09-12 NITRO 07-10	
				JEEP WRANGLER 07-10	
No. Lusac: 23220 Producto: REP. FRENO DE DISCO 		No. Lusac: 23260 Producto: REP. FRENO DE DISCO 		No. Lusac: 23270 Producto: REP. FRENO DE DISCO 	
DIAMETRO	63.5 mm 2-1/2"	DIAMETRO	50.8 mm 2"	DIAMETRO	60.3 mm 2-3/8"
TOYOTA CAMRY LE XLE 02-07 RAV4 06-10 SIENNA CE LE XLE 04-10		TOYOTA YARIS HATCH BACK 04-07		TOYOTA RAV4 04-07	
No. Lusac: 23271 Producto: REP. FRENO DE DISCO  Imagen Disponible Próximamente		No. Lusac: 59176 Producto: REP. FRENO DE DISCO 		No. Lusac: 76090 Producto: REP. FRENO DE DISCO 	
DIAMETRO	32.1 mm 1-17/64"	DIAMETRO	74.6 mm 2-15/16"	DIAMETRO	73.0 mm 2-7/8"
TOYOTA RAV4 BASE Y LIMITED 04-07		CHEVROLET C15 82-86 C20 79-86 CHEVY VAN 95		JEEP WAGONEER 85-86	
				FORD F150 84-85 90-91	

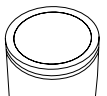

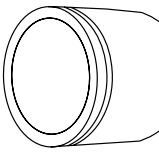

No. Lusac: 83297		No. Lusac: 83691		No. Lusac: 98948			
Producto: REP. FRENO DE DISCO		Producto: REP. FRENO DE DISCO		Producto: REP. FRENO DE DISCO			
DIAMETRO	85.7 mm 3-3/8"	DIAMETRO	65.9 mm 2-19/32"	DIAMETRO	73.0 mm 2-7/8"		
CHEVROLET C30 84-86 MICROBUS 88-96		DODGE DART 73-76 DUSTER 73-76 FORD F150 80-83 MAVERICK 74-77 MUSTANG 74-78 WINDSTAR GL LX 95-98 JEEP CJ-5 78-78		LINCOLN CONTINENTAL 97-99 MARK VIII 94-96 MERCURY SABLE VAGONETA 94-04 VAM AMERICAN 77-83 CLASSIC 76-76 RALLY 76-83		FORD CROWN VICTORIA 81-81 GRAND MARQUIS 82-84 92-94 LTD 79-80 LINCOLN TOWN CAR 91-94	
No. Lusac: 99024		No. Lusac: 99079		No. Lusac: 100797			
Producto: REP. FRENO DE DISCO		Producto: REP. FRENO DE DISCO		Producto: REP. FRENO DE DISCO			
DIAMETRO	63.5 mm 2-1/2"	DIAMETRO	60.0 mm	DIAMETRO	57.1 mm 2-1/4"		
BUICK CENTURY 83-96 CADILLAC DEVILLE CONCOURS 94-96 91-93 00-04 SEVILLE STS 03-04 CHEVROLET BLAZER 95-97 CAMARO 95-97 LUMINA 95-96 S-10 95-04 UPLANDER 05-09 VENTURE APV 97		OLDSMOBILE CUTLASS 90-96 EIGHTY EIGHT 99, 94-95 EUROSPOUT 91-96 SILHOUETTE 91-92 94-95 PONTIAC BONNEVILLE 94-99 FIREBIRD TRANS AM 94-97 MONTANA SV6 08-09		FORD THUNDERBIRD 85-88		CHEVROLET CAVALIER Z24 90-04 CELEBRITY 85-89 CITATION 82-85 OLDSMOBILE CUTLASS 87-89 PONTIAC SUNFIRE 97-02 04-05	

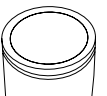

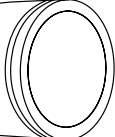



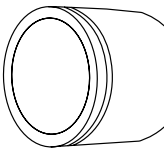

Fotografías de producto y especificaciones

No. Lusac: 101491		No. Lusac: 102443		No. Lusac: 108241	
Producto: REP. FRENO DE DISCO		Producto: REP. FRENO DE DISCO		Producto: REP. FRENO DE DISCO	
DIAMETRO	78.6 mm 3-3/32"	DIAMETRO	54.0 mm 2-1/8"	DIAMETRO	60.0 mm
DODGE D150 83-93 RAM VAN 3500 95-97 D250 86-90 93 RAM WAGON 1500 95-97 D350 81-93 RAM WAGON 2500 96-97 RAM 3500 MAXI WAGON 95-97 W150 85-87 RAM CHARGER 86-93 95-96 W250 86-93 RAM VAN 1500 95-97 RAM VAN 2500 96-97		CHRYSLER LE BARON K 83-87 RAM WAGON 1500 98-03 NEW YORKER 85-89 RAM WAGON 2500 98-02 PHANTOM 87-89 SERIE 600K 84-85 DODGE SHADOW 89-94 RAM 1500 07-08 SPIRIT 90-95 RAM 2500 01-02 RAM VAN 1500 98-03 VOLKSWAGEN RAM VAN 2500 98-02 POINTER GTI VAGONETA 00-09		CHRYSLER GRAND VOYAGER 95-00 GHIA 91-94 TOWN & COUNTRY 93-00 TOPAZ 84-94 VOYAGER 95-00 NISSAN FORD QUEST 97-02 F350 13-14	
No. Lusac: 118265		No. Lusac: 04-112486		No. Lusac: 2022R	
Producto: REP. FRENO DE DISCO		Producto: REP. FRENO DE DISCO		Producto: REP. FRENO DE DISCO	
DIAMETRO	34.1 mm 1-11/32"	DIAMETRO	65.9 mm 2-19/32"	DIAMETRO	38.1 mm 1-1/2"
CHRYSLER CIRRUS CONVERTIBLE COUPE 96-05 SEBRING R/T 97-97 CONCORDE 93-97 STRATUS 96-06 LE BARON 92-95 DODGE LHS 94-97 INTREPID 94-97 NEON 95-05 SHADOW GTS Y TURBO 89-89 NEW YORKER 90-97 SPIRIT R/T 91-95 PHANTOM 90-94		FORD TAURUS 88-91 THUNDERBIRD 89-92		NISSAN 300ZX 91-96	







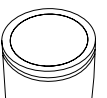

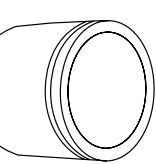

No. Lusac: 2024R		No. Lusac: 88562D		No. Lusac: WK-1454	
Producto: REP. FRENO DE DISCO		Producto: REP. FRENO DE DISCO		Producto: REP. FRENO DE DISCO	
					
DIAMETRO	40.5 mm 1-19/32"	DIAMETRO	55.6 mm 2-3/16"	DIAMETRO	N/D
NISSAN 300ZX 91-96		FORD F200 87-91		MITSUBISHI GALANT 03-03	
No. Lusac: WK-1808					
Producto: REP. FRENO DE DISCO					
					
DIAMETRO	N/D				
NISSAN 240SX 98					



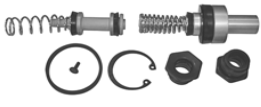

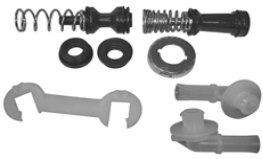
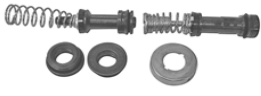



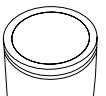

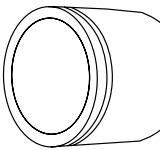



Fotografías de producto y especificaciones

No. Lusac: 130 Producto: REP. CIL. MAESTRO Y DE CLUTCH 		No. Lusac: 152 Producto: REP. CIL. MAESTRO Y DE CLUTCH 		No. Lusac: 193 Producto: REP. CIL. MAESTRO Y DE CLUTCH 	
DIAMETRO	17.4 mm 11/16"	DIAMETRO	23.8 mm 15/16"	DIAMETRO	20.6 mm 13/16"
VOLKSWAGEN SEDAN 83-91		VOLKSWAGEN COMBI 90-01 PANEL 90-01		VOLKSWAGEN GOLF A3 GTI 97-98 JETTA A3 GLS, EUROPA, 97-98	
No. Lusac: 194 Producto: REP. CIL. MAESTRO Y DE CLUTCH 		No. Lusac: 686 Producto: REP. CIL. MAESTRO Y DE CLUTCH 		No. Lusac: 691 Producto: REP. CIL. MAESTRO Y DE CLUTCH 	
DIAMETRO	20.6 mm 13/16"	DIAMETRO	22.2 mm 7/8"	DIAMETRO	23.8 mm 15/16"
VOLKSWAGEN GOLF A2 C, CL 87-92 JETTA A2 87, 89		NISSAN PICKUP NISSAN DOBLE CABINA 83-83		NISSAN ICHI VAN 87-94	
No. Lusac: 693 Producto: REP. CIL. MAESTRO Y DE CLUTCH 		No. Lusac: 694 Producto: REP. CIL. MAESTRO Y DE CLUTCH 		No. Lusac: 730 Producto: REP. CIL. MAESTRO Y DE CLUTCH 	
DIAMETRO	19.0 mm 3/4"	DIAMETRO	20.6 mm 13/16"	DIAMETRO	22.2 mm 7/8"
NISSAN TSURU III GS 93-15		NISSAN SENTRA GST, GSX 96-00 TSUBAME 93-99		DODGE D150 92-93 D250 92-93 D350 92-93 MICROBUS 92-93 RAM CHARGER 92-93	
				JEEP CHEROKEE 93-93 WAGONEER 93-93	







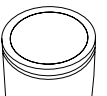

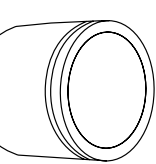



<p>No. Lusac: 735</p> <p>Producto: REP. CIL. MAESTRO Y DE CLUTCH</p>  <p>Imagen Disponible Próximamente</p>		<p>No. Lusac: 830</p> <p>Producto: REP. CIL. MAESTRO Y DE CLUTCH</p> 		<p>No. Lusac: 840</p> <p>Producto: REP. CIL. MAESTRO Y DE CLUTCH</p>  <p>Imagen Disponible Próximamente</p>	
DIAMETRO	25.4 mm 1"	DIAMETRO	20.6 mm 13/16"	DIAMETRO	23.0 mm 29/32"
<p>DODGE</p> <p>D150 92-93</p> <p>D250 92-93</p> <p>D350 92-93</p> <p>MICROBUS 92-93</p> <p>RAM CHARGER 92-93</p>		<p>JEEP</p> <p>CHEROKEE 93-93</p> <p>WAGONEER 93-93</p>		<p>CHEVROLET</p> <p>CHEVY SWING JOY, POP, MONZA, VAGONETA 95-03</p> <p>CHEVY PICKUP 99, 03</p>	
				<p>CHEVROLET</p> <p>MICROBUS 92-94</p> <p>P30 92-94</p> <p>P3500 92-94</p>	
<p>No. Lusac: 845</p> <p>Producto: REP. CIL. MAESTRO Y DE CLUTCH</p>  <p>Imagen Disponible Próximamente</p>		<p>No. Lusac: 1737</p> <p>Producto: REP. CIL. MAESTRO Y DE CLUTCH</p> 		<p>No. Lusac: 1831</p> <p>Producto: REP. CIL. MAESTRO Y DE CLUTCH</p> 	
DIAMETRO	20.0 mm	DIAMETRO	28.5 mm 1-1/8"	DIAMETRO	24.0 mm
<p>CHEVROLET</p> <p>MICROBUS 92-94</p> <p>P30 92-94</p>		<p>CHEVROLET</p> <p>C2500 89-94</p>		<p>DODGE</p> <p>RAM 1500 94</p>	
				<p>BUICK</p> <p>CENTURY 94-96</p> <p>OLDSMOBILE</p> <p>CUTLASS 94-96</p> <p>EUROSPORT 94-96</p>	
<p>No. Lusac: 2726</p> <p>Producto: REP. CIL. MAESTRO Y DE CLUTCH</p> 		<p>No. Lusac: 9953</p> <p>Producto: REP. CIL. MAESTRO Y DE CLUTCH</p> 		<p>No. Lusac: 39650</p> <p>Producto: REP. CIL. MAESTRO Y DE CLUTCH</p> 	
DIAMETRO	20.6 mm 13/16"	DIAMETRO	25.4 mm 1"	DIAMETRO	31.7 mm 1-1/4"
<p>DODGE</p> <p>ATOS 04-07</p>		<p>FORD</p> <p>EXPLORER SPORT 91-95</p>		<p>CHEVROLET</p> <p>C3500 90-90</p>	







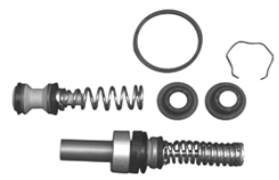



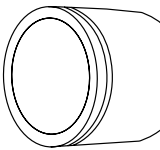



Fotografías de producto y especificaciones

<p>No. Lusac: 60051</p> <p>Producto: REP. CIL. MAESTRO Y DE CLUTCH</p>  <p>Imagen Disponible Próximamente</p>		<p>No. Lusac: 86626</p> <p>Producto: REP. CIL. MAESTRO Y DE CLUTCH</p> 		<p>No. Lusac: 90060</p> <p>Producto: REP. CIL. MAESTRO Y DE CLUTCH</p> 	
DIAMETRO	25.4 mm 1"	DIAMETRO	28.5 mm 1-1/8"	DIAMETRO	20.6 mm 13/16"
<p>DODGE</p> <p>RAM 1500 94-97 RAM 3500 94-97</p> <p>RAM 2500 94-97</p>		<p>DODGE</p> <p>D350 INCLUYE MICROBUS 91-93</p> <p>W250 89-93</p>		<p>VOLKSWAGEN</p> <p>CABRIO A3 96 JETTA A2 92</p> <p>GOLF A2 GTI 91-92</p>	
<p>No. Lusac: 90185</p> <p>Producto: REP. CIL. MAESTRO Y DE CLUTCH</p> 		<p>No. Lusac: 90234</p> <p>Producto: REP. CIL. MAESTRO Y DE CLUTCH</p> 		<p>No. Lusac: 90251</p> <p>Producto: REP. CIL. MAESTRO Y DE CLUTCH</p> 	
DIAMETRO	26.9 mm 1-1/16"	DIAMETRO	23.8 mm 15/16"	DIAMETRO	22.2 mm 7/8"
<p>FORD</p> <p>MUSTANG GT 94-95</p>		<p>NISSAN</p> <p>MAXIMA 95-01</p> <p>SENTRA SE, SE-R, XE, GXE 01-12</p>		<p>CHRYSLER</p> <p>CIRRUS 96-00 STRATUS 95-02</p> <p>SEBRING RT 97-97</p>	
<p>No. Lusac: 90271</p> <p>Producto: REP. CIL. MAESTRO Y DE CLUTCH</p> 		<p>No. Lusac: 90279</p> <p>Producto: REP. CIL. MAESTRO Y DE CLUTCH</p> 		<p>No. Lusac: 90303</p> <p>Producto: REP. CIL. MAESTRO Y DE CLUTCH</p> 	
DIAMETRO	22.2 mm 7/8"	DIAMETRO	31.7 mm 1-1/4"	DIAMETRO	25.4 mm 1"
<p>VOLKSWAGEN</p> <p>CABRIO A4 02 JETTA A3 VR6 95-98</p> <p>GOLF A3 GTI VR6 95-98</p>		<p>CHEVROLET</p> <p>C3500 95-99 P30 PANEL 99-00</p> <p>C3500HD 96-99</p>		<p>JEEP</p> <p>CHEROKEE SPORT 98-01</p> <p>GRAND CHEROKEE 95-98</p>	

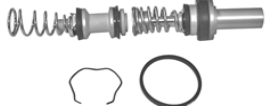





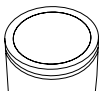

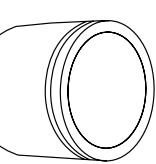

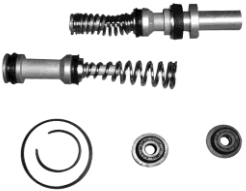

No. Lusac: 90318 Producto: REP. CIL. MAESTRO Y DE CLUTCH		No. Lusac: 90337 Producto: REP. CIL. MAESTRO Y DE CLUTCH		No. Lusac: 90386 Producto: REP. CIL. MAESTRO Y DE CLUTCH	
					
DIAMETRO	22.2 mm 7/8"	DIAMETRO	31.7 mm 1-1/4"	DIAMETRO	25.4 mm 1"
NISSAN LUCINO GSE GSR 96-00 TSURU GSR 2000 95-96		FORD EXPEDITION INLCUYE EDDIE BAUER XLT, 97-06 P350 MICROBUS 97-97 F150 00-01 F250 XL 97-98 LOBO 01-04		CHEVROLET MALIBU LX, LS 97-01, 05 PONTIAC GRAND AM 99-00	
No. Lusac: 90398 Producto: REP. CIL. MAESTRO Y DE CLUTCH		No. Lusac: 90426 Producto: REP. CIL. MAESTRO Y DE CLUTCH		No. Lusac: 90463 Producto: REP. CIL. MAESTRO Y DE CLUTCH	
					
DIAMETRO	26.9 mm 1-1/16"	DIAMETRO	31.7 mm 1-1/4"	DIAMETRO	25.4 mm 1"
FORD EXPLORER EDDIE BAUER SPORT 98-05 RANGER 01-06		LINCOLN AVIATOR 03-05 DODGE RAM 1500 98-01 RAM 2500 INCLUYE QUAD CAB 00-01 RAM 3500 98-02		FORD CONTOUR 97-00 MERCURY MYSTIQUE 97-00	
No. Lusac: 90516 Producto: REP. CIL. MAESTRO Y DE CLUTCH		No. Lusac: 90531 Producto: REP. CIL. MAESTRO Y DE CLUTCH		No. Lusac: 90707 Producto: REP. CIL. MAESTRO Y DE CLUTCH	
					
DIAMETRO	31.7 mm 1-1/4"	DIAMETRO	34.9 mm 1-3/8"	DIAMETRO	26.9 mm 1-1/16"
CHRYSLER TOWN & COUNTRY 97-00 DODGE RAM 3500 MAXI WAGON 98-02 RAM VAN 1500 98-03 RAM VAN 2500 96-02		FORD F550 01-07		CHRYSLER VOYAGER 01-04	









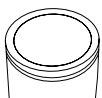

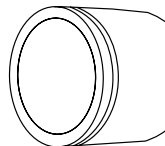



Fotografías de producto y especificaciones

<p>No. Lusac: 90711</p> <p>Producto: REP. CIL. MAESTRO Y DE CLUTCH</p> 		<p>No. Lusac: 90901</p> <p>Producto: REP. CIL. MAESTRO Y DE CLUTCH</p> 		<p>No. Lusac: 99984</p> <p>Producto: REP. CIL. MAESTRO Y DE CLUTCH</p> 	
DIAMETRO	26.9 mm 1-1/16"	DIAMETRO	20.6 mm 13/16"	DIAMETRO	22.2 mm 7/8"
<p>JEEP</p> <p>LIBERTY 02-06</p>		<p>VOLKSWAGEN</p> <p>POINTER CITY VAGONETA 98-02</p>		<p>BUICK CHEVROLET</p> <p>CENTURY 83-86 CITATION 82-85</p>	
<p>No. Lusac: 101928</p> <p>Producto: REP. CIL. MAESTRO Y DE CLUTCH</p> 		<p>No. Lusac: 104459</p> <p>Producto: REP. CIL. MAESTRO Y DE CLUTCH</p> 		<p>No. Lusac: 104467</p> <p>Producto: REP. CIL. MAESTRO Y DE CLUTCH</p> 	
DIAMETRO	28.5 mm 1-1/8"	DIAMETRO	28.5 mm 1-1/8"	DIAMETRO	25.4 mm 1"
<p>DODGE</p> <p>D250 86-90, 93 RAM WAGON 1500 95</p> <p>RAM CHARGER 86-93 95-96 W150 85-87</p> <p>RAM VAN 1500 95</p>		<p>CHEVROLET DODGE</p> <p>C15 82-86 RAM 1500 95-96</p> <p>C20 79-86 JEEP</p> <p>SONORA 00 WAGONEER 85-86</p> <p>SUBURBAN 1500 2500 00-02</p>		<p>CHEVROLET</p> <p>C1500 88-91</p>	
<p>No. Lusac: 105838</p> <p>Producto: REP. CIL. MAESTRO Y DE CLUTCH</p> 		<p>No. Lusac: 107051</p> <p>Producto: REP. CIL. MAESTRO Y DE CLUTCH</p> 		<p>No. Lusac: 107056</p> <p>Producto: REP. CIL. MAESTRO Y DE CLUTCH</p> 	
DIAMETRO	34.0 mm	DIAMETRO	24.0 mm	DIAMETRO	24.0 mm
<p>CHEVROLET</p> <p>MICROBUS 94-96</p> <p>P30 PANEL 94-95</p>		<p>CHEVROLET</p> <p>BLAZER 95</p> <p>S-10 95</p>		<p>CHEVROLET</p> <p>CELEBRITY 85-86</p>	







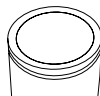

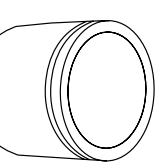
No. Lusac: 108657 Producto: REP. CIL. MAESTRO Y DE CLUTCH		No. Lusac: 112115 Producto: REP. CIL. MAESTRO Y DE CLUTCH		No. Lusac: 112246 Producto: REP. CIL. MAESTRO Y DE CLUTCH	
					
DIAMETRO	20.0 mm	DIAMETRO	21.0 mm 53/64"	DIAMETRO	24.0 mm
FORD GHIA 91-94 TOPAZ 84-94		CHRYSLER LE BARON K 83-87 NEW YORKER 85-89 PHANTOM 87-89		DODGE SERIE 600K 84-85 SHADOW 89-94	
		CHRYSLER GRAND VOYAGER 95 IMPERIAL 91 LE BARON 92-95 NEW YORKER 90-93 PHANTOM 90-94		TOWN & COUNTRY 93-95 VOYAGER 95 DODGE SPIRIT RT 91-92	
No. Lusac: 112592 Producto: REP. CIL. MAESTRO Y DE CLUTCH		No. Lusac: 114084 Producto: REP. CIL. MAESTRO Y DE CLUTCH		No. Lusac: 114085 Producto: REP. CIL. MAESTRO Y DE CLUTCH	
					
DIAMETRO	22.2 mm 7/8"	DIAMETRO	26.9 mm 1-1/16"	DIAMETRO	28.5 mm 1-1/8"
FORD TAURUS 88-89		FORD E150 ECONLINE WAGON VAN 95-96 F150 87-97 97-98 98-99		FORD E150 ECONLINE WAGON, VAN 97 E350 ECONLINE CLUB WAGON 95-96 F250 93-95 P350 MICROBUS 96	
No. Lusac: 114191 Producto: REP. CIL. MAESTRO Y DE CLUTCH		No. Lusac: 114196 Producto: REP. CIL. MAESTRO Y DE CLUTCH		No. Lusac: 116612 Producto: REP. CIL. MAESTRO Y DE CLUTCH	
					
DIAMETRO	22.2 mm 7/8"	DIAMETRO	24.0 mm	DIAMETRO	22.2 mm 7/8"
BUICK CENTURY 87-89 CHEVROLET CAVALIER, Z24 91-96, 90-04		PONTIAC SUNFIRE 97-02 04-05		BUICK CENTURY 90-93 REGAL 94-96 CHEVROLET CELEBRITY 87-89 LUMINA 95-96	
		OLDSMOBILE CUTLASS 87-93 EUROSPOUR 91-93 SILHOUETTE 91-92 94-95		DODGE SHADOW GTS 89 SPIRIT 90-95	





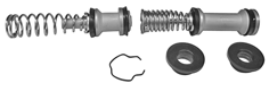
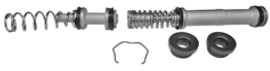

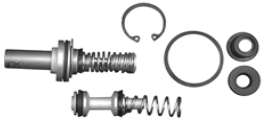
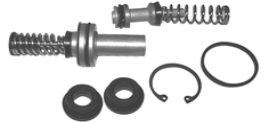
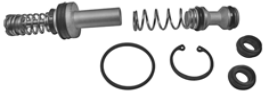

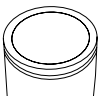

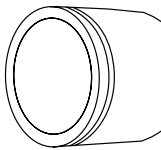
Fotografías de producto y especificaciones

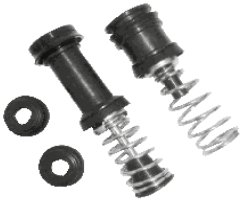
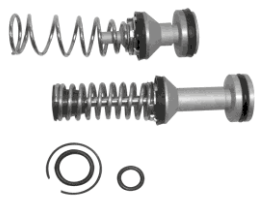
No. Lusac: 120591 Producto: REP. CIL. MAESTRO Y DE CLUTCH 		No. Lusac: 120795 Producto: REP. CIL. MAESTRO Y DE CLUTCH 		No. Lusac: 120797 Producto: REP. CIL. MAESTRO Y DE CLUTCH 	
DIAMETRO	31.7 mm 1-1/4"	DIAMETRO	23.8 mm 15/16"	DIAMETRO	25.4 mm 1"
CHEVROLET MICROBUS 92-93		FORD THUNDERBIRD 89		FORD MERCURY COUGAR 90-95 SABLE VAGONETA 94-95 THUNDERBIRD 90-92, 94	
No. Lusac: 128405 Producto: REP. CIL. MAESTRO Y DE CLUTCH 		No. Lusac: 903310 Producto: REP. CIL. MAESTRO Y DE CLUTCH 		No. Lusac: 903320 Producto: REP. CIL. MAESTRO Y DE CLUTCH 	
DIAMETRO	60.0mm	DIAMETRO	23.8 mm 15/16"	DIAMETRO	23.8 mm 15/16"
CHRYSLER DODGE CONCORDE 93-97 INTREPID 94-97 NEW YORKER LH LHS 95-96		FORD FOCUS LX, SVT, ZX3 05-06, 02, 00-04		FORD COURIER PICKUP 01-10 IKON 01-07 FIESTA 98-01	
No. Lusac: 903330 Producto: REP. CIL. MAESTRO Y DE CLUTCH 		No. Lusac: 904080 Producto: REP. CIL. MAESTRO Y DE CLUTCH 		No. Lusac: 904081 Producto: REP. CIL. MAESTRO Y DE CLUTCH 	
DIAMETRO	22.2 mm 7/8"	DIAMETRO	20.6 mm 13/16"	DIAMETRO	23.8 mm 15/16"
FORD KA INCLUYE SPORT 01-08		NISSAN RENAULT PLATINA 02-10 CLIO ENERGY EXPRESSION 02 10		FORD ECOSPORT 04-10	



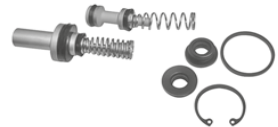
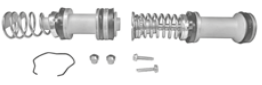

<p>No. Lusac: 904086</p> <p>Producto: REP. CIL. MAESTRO Y DE CLUTCH</p> 		<p>No. Lusac: 904090</p> <p>Producto: REP. CIL. MAESTRO Y DE CLUTCH</p> 		<p>No. Lusac: 904092</p> <p>Producto: REP. CIL. MAESTRO Y DE CLUTCH</p> 	
DIAMETRO	24.5mm 1"	DIAMETRO	34.0mm	DIAMETRO	20.6 mm 13/16"
<p>NISSAN</p> <p>URVAN CARGA 00-11</p>		<p>CADILLAC</p> <p>ESCALADE 02-06 EXPRESS 2500, CARGO VAN 07-08, 11-13</p> <p>CHEVROLET</p> <p>EXPRESS 1500 CARGO VAN Y 8 PASAJEROS 03-08</p>		<p>CHEVROLET</p> <p>MATIZ 04-11</p>	
<p>No. Lusac: 904093</p> <p>Producto: REP. CIL. MAESTRO Y DE CLUTCH</p> 		<p>No. Lusac: 908080</p> <p>Producto: REP. CIL. MAESTRO Y DE CLUTCH</p> 		<p>No. Lusac: 987700</p> <p>Producto: REP. CIL. MAESTRO Y DE CLUTCH</p> 	
DIAMETRO	23.8mm 15/16"	DIAMETRO	22.2 mm 7/8"	DIAMETRO	20.6 mm 13/16"
<p>VOLKSWAGEN</p> <p>EUROVAN 06-09 00-04</p>		<p>CHEVROLET</p> <p>CORSA 02-05</p>		<p>VOLKSWAGEN</p> <p>GOLF A3 CL, GL 97-99</p>	
<p>No. Lusac: 113441A</p> <p>Producto: REP. CIL. MAESTRO Y DE CLUTCH</p> 		<p>No. Lusac: 96404-LC</p> <p>Producto: REP. CIL. MAESTRO Y DE CLUTCH</p> 			
DIAMETRO	33.3 mm 1-5/16"	DIAMETRO	19.0 mm 3/4"		
<p>CHEVROLET</p> <p>MICROBUS 88-91</p>		<p>VOLKSWAGEN</p> <p>SEDAN 92-04</p>			

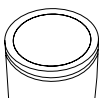

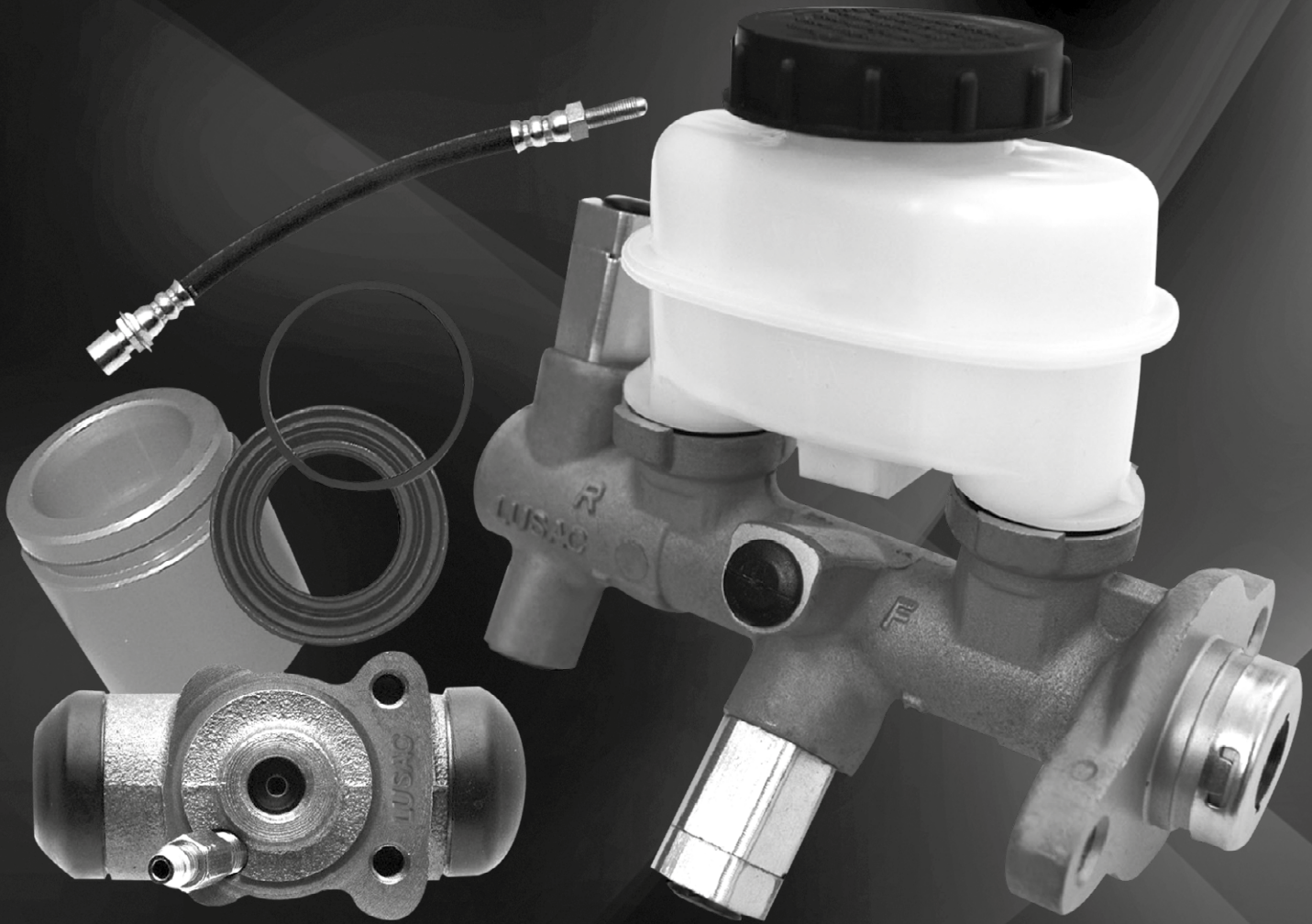

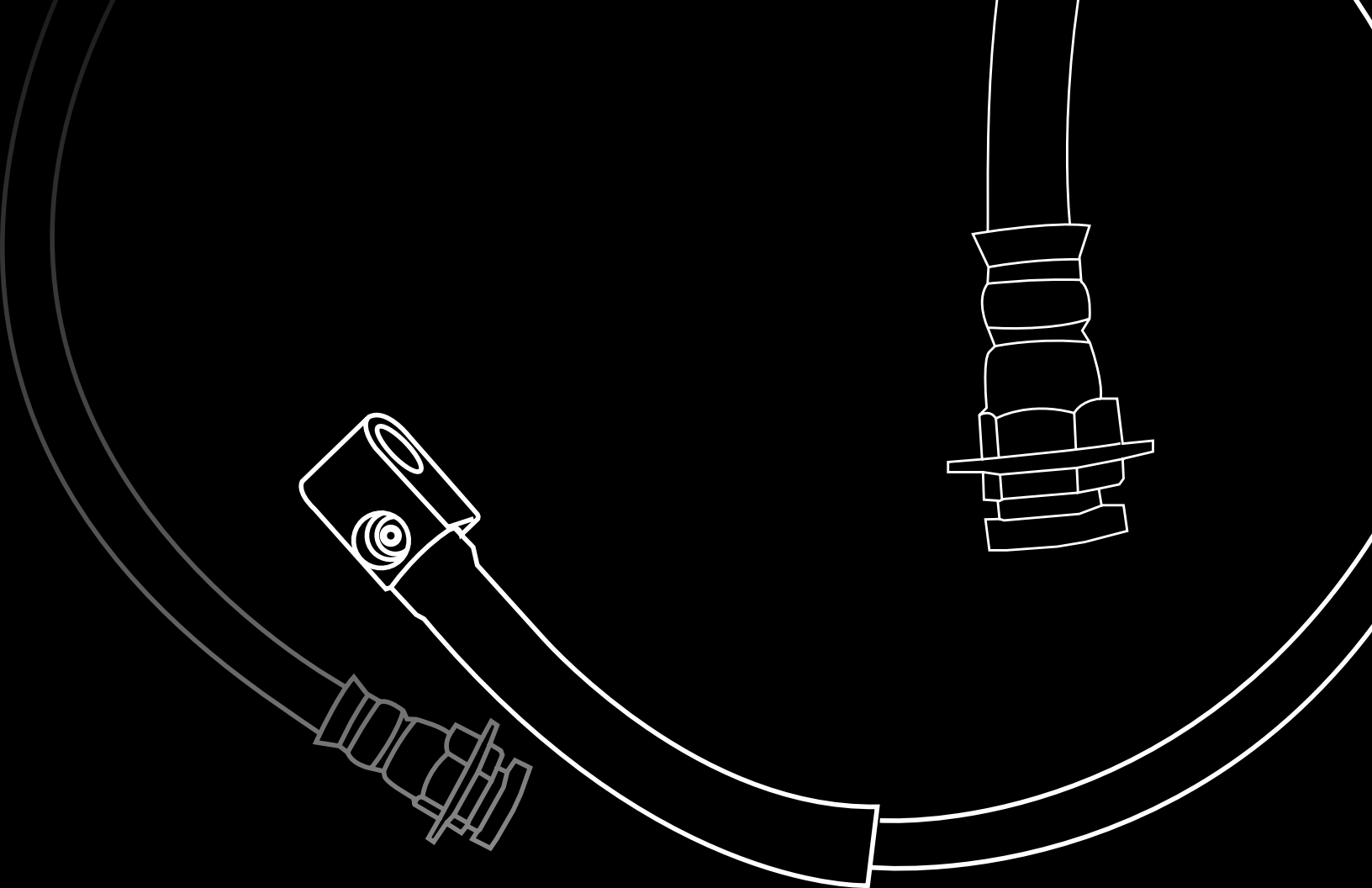

Lusac[®]



Medidas y especificaciones

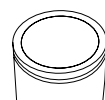

Medidas y especificaciones



CILINDROS MAESTROS

No PARTE LUSAC	No PARTE RAYBESTOS	No REPTO LUSAC	MEDIDA	GEN	NO. DE CONEX	DIÁM. DE CONEX. 1	DIÁM. DE CONEX. 2	DIÁM. DE CONEX. 3	DIÁM. DE CONEX. 4
544	MC544	3613	31.7 mm 1-1/4"	SENCILLO	3	1/4" X 18 NPT	3/8" X 18 NPT	1/8" X 27 NPT	
661	MC661	3622	38.1 mm 1-1/2"	SENCILLO	3	1/2" X 20	1/2" X 20	1/8" X 27 NPT	
785	MC785	3649	38.1 mm 1-1/2"	SENCILLO	3	3/8" X 18 NPT	1/4" X 18 NPT	1/8" X 27 NPT	
1050	MC1050	5375	26.9 mm 1-1/16"	SENCILLO	1	1/2" X 20			
1251	MC1251	5350	44.4 mm 1-3/4"	SENCILLO	4	1/2" X 20	1/2" X 20	1/2" X 20	1/8" X 27 NPT
1461	MC36483	3631	28.5 mm 1-1/8"	SENCILLO	1	1/2" X 20			
1722	MC1722	3631	28.5 mm 1-1/8"	SENCILLO	1	1/2" X 20			
2796	MC2796	11300	25.4 mm 1"	SENCILLO	1	1/2" X 20			
2842	MC2842	8449	44.4 mm 1-3/4"	SENCILLO	4	1/2" X 20	1/2" X 20	1/2" X 20	1/8" X 27 NPT
3241	MC3241	13504	28.5 mm 1-1/8"	SENCILLO	2	3/8" X 24	3/8" X 24		
3434	MC3434	3626	25.4 mm 1"	SENCILLO	2	7/16" X 24	1/8" X 27 NPT		
3573	MC3573	3631	28.5 mm 1-1/8"	SENCILLO	3	1/2" X 20	1/2" X 20	1/8" X 27 NPT	
4572	MC4572	3613	31.7 mm 1-1/4"	SENCILLO	1	7/16" X 24			
9220	MC9220	3630	31.7 mm 1-1/4"	SENCILLO	1	7/16"-24	7/16"-24		
9221	MC9221	3630	31.7 mm 1-1/4"	SENCILLO	2	1/2" X 20	1/2" X 20		
14019	MC14019	5375	26.9 mm 1-1/16"	SENCILLO	1	1/2" X 20			
14021	MC14021	3613	31.7 mm 1-1/4"	SENCILLO	1	7/16" X 24			
18000	MC18000	13634	25.4 mm 1"	SENCILLO	1	1/2" X 20			
19450	MC19450	19435	38.1 mm 1-1/2"	SENCILLO	1	1/2" X 20			
21000	MC21000	19356	25.4 mm 1"	SENCILLO	2	7/16" X 24	7/16" X 24		
21680	MC21680	13621	28.5 mm 1-1/8"	SENCILLO	2	1/2" X 20	1/2" X 20		
21918	MC21918	13621	28.5 mm 1-1/8"	SENCILLO	1	1/2" X 20			
22975	MC22975	19429	26.9 mm 1-1/16"	SENCILLO	1	1/2" X 20			
22976	MC22976	19430	31.7 mm 1-1/4"	SENCILLO	1	1/2" X 20			
22977	MC22977	19432	38.1 mm 1-1/2"	SENCILLO	1	1/2" X 20			
22978	MC36177	19431	44.4 mm 1-3/4"	SENCILLO	1	1/2" X 20			
25517	MC25517	106356	26.9 mm 1-1/16"	SENCILLO	1	1/2" X 20			
27047	MC36063	19372	28.5 mm 1-1/8"	SENCILLO	2	1/4" X 18 NPT	1/4" X 18 NPT		
27304	MC27304	19432	38.1 mm 1-1/2"	SENCILLO	1	1/2" X 20			
32839	MC36066	31092	28.5 mm 1-1/8"	SENCILLO	2	1/4" X 18 NPT			
32900	MC32900	13634	25.4 mm 1"	SENCILLO	2	1/8" X 27 NPT	1/4" X 18 NPT		
34224	MC35036	33108	25.4 mm 1"	SENCILLO	1	7/16" X 24			
34403	MC34403	33160	28.5 mm 1-1/8"	SENCILLO	2	7/16" X 24	1/8" X 27 NPT		
34404	MC34404	33160	28.5 mm 1-1/8"	SENCILLO	2	7/16" X 24	7/16" X 24		
34451	MC7819089 A	464480	31.7 mm 1-1/4"	SENCILLO	2	7/16" X 24	7/16" X 24		
36313	MC36067	33192	25.4 mm 1"	SENCILLO	1	1/2" X 20			
36413	MC36413	N/D	19.0 mm 3/4"	SENCILLO	1	3/8 X 24			
36482	MC36482	N/D	19.0 mm 3/4"	SEGUNDA	2	M10 X 1	M10 X 1		
36666	MC21698	3630	31.7 mm 1-1/4"	SENCILLO	1	7/16" X 24			
36706	MC36218	33158	25.4 mm 1"	SENCILLO	2	7/16" X 24	1/4" X 18 NPT		
37073	MC36071	33196	28.5 mm 1-1/8"	SENCILLO	2	1/8" X 27 NPT	1/8" X 27 NPT		
39006	MC39006	N/D	19.0 mm 3/4"	TERCERA	2	M10 X 1	M10 X 1		
39009	MC39009	N/D	28.5 mm 1-1/8"	SEGUNDA	2	1/2" X 20	9/16" X 18		
39038	MC39038	N/D	23.8 mm 15/16"	SEGUNDA	2	M10 X 1	M10 X 1		
39039	MC39039	N/D	20.6 mm 13/16"	SEGUNDA	2	M10 X 1	M10 X 1		
39040	MC39040	N/D	20.6 mm 13/16"	SEGUNDA	2	M10 X 1	M10 X 1		
39087	MC39087	N/D	17.4 mm 11/16"	TERCERA	2	M10 X 1	M10 X 1		
39153	MC39153	N/D	20.6 mm 13/16"	SEGUNDA	2	M10 X 1	M10 X 1		
39210	MC39210	N/D	24.0 mm	TERCERA	2	9/16 X 18	1/2 X 20		
39276	MC39276	686	22.2 mm 7/8"	SEGUNDA	2	M10 X 1	M10 X 1		
39297	MC39297	N/D	15.8 y 22.2mm	TERCERA	2	M10 X 1	M10 X 1		
39298	MC39298	N/D	15.8 y 22.2mm	TERCERA	2	M10 X 1	M10 X 1		
39308	MC39308	N/D	30 mm	TERCERA	2	1/2 X 20	9/16 X 18		
39317	MC39317	N/D	22.2 mm 7/8"	SEGUNDA	2	M10 X 1	M10 X 1		
39319	MC39319	N/D	22.2 mm 7/8"	SEGUNDA	2	M10 X 1	M10 X 1		



Medidas y especificaciones

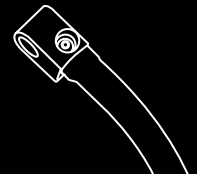
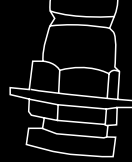

CILINDROS MAESTROS									
No PARTE LUSAC	No PARTE RAYBESTOS	No REPTO LUSAC	MEDIDA	GEN	NO. DE CONEX	DIÁM. DE CONEX. 1	DIÁM. DE CONEX. 2	DIÁM. DE CONEX. 3	DIÁM. DE CONEX. 4
39330	MC39330	N/D	29.0 y 40.0 mm	TERCERA	2	9/16 X 18	1/2 X 20		
39348	MC39348	N/D	23.8 mm 15/16"	TERCERA	2	M10 X 1	M10 X 1		
39355	MC39355	N/D	25.4 y 36.0mm	CUARTA	2	1/2 X 20	9/16 X 18		
39360	MC39360	N/D	20.6 mm 13/16"	TERCERA	2	M10 X 1	M10 X 1		
39364	MC39364	N/D	22.2 mm 7/8"	TERCERA	2	M10 X 1.25	M10 X 1.25		
39385	MC39385	N/D	24.0 y 31.7 mm	CUARTA	2	1/2 X 20	9/16 X 18		
39388	MC39388	N/D	23.8 mm 15/16"	TERCERA	2	7/16 X 24	9/16 X 18		
39403	MC39403	N/D	23.8 mm 15/16"	SEGUNDA	2	M10 X 1	M10 X 1		
39404	MC39404	N/D	23.8 mm 15/16"	TERCERA	2	M10 X 1	M10 X 1		
39406	MC39406	688	19.0 y 23.8 mm	CUARTA	2	M10 X 1	M10 X 1		
39411	MC39411	N/D	22.2 mm 7/8"	TERCERA	2	M10 X 1	M10 X 1		
39413	MC39413	N/D	28.6 y 40.0 mm	CUARTA	2	9/16 X 18	1/2 X 20		
39419	MC39419	N/D	23.8 mm 15/16"	TERCERA	2	7/16 X24	1/2 X 20		
39422	MC39422	N/D	22.2 mm 7/8"	SEGUNDA	2	M10 X 1	M10 X 1		
39423	MC39423	N/D	20.6 mm 13/16"	SEGUNDA	2	M10 X 1	M10 X 1		
39426	MC39426	N/D	20.6 mm 13/16"	TERCERA	2	M10 X 1	M10 X 1		
39453	MC39453	N/D	22.2 mm 7/8"	TERCERA	2	M10 X 1	M10 X 1		
39454	MC39454	N/D	20.6 mm 13/16"	TERCERA	2	M10 X 1	M10 X 1		
39458	MC39458	N/D	20.6 mm 13/16"	TERCERA	2	M10 X 1	M10 X 1		
39465	MC39465	N/D	20.6 mm 13/16"	SEGUNDA	2	M10 X 1.25	M10 X 1.25		
39473	MC39473	N/D	22.2 mm 7/8"	TERCERA	2	M10 X 1	M10 X 1		
39486	MC39486	N/D	22.2 mm 7/8"	TERCERA	2	M10 X 1	M10 X 1		
39498	MC39498	N/D	19.7 y 28.6 mm	CUARTA	4	M12 X 1	M12 X 1	M18 X 1	M18 X 1
39499	MC39499	N/D	20.6 mm 13/16"	TERCERA	3	M10x1.25	M10x1.25	M10x1.25	
39500	MC39500	N/D	20.6 mm 13/16"	TERCERA	2	M10 X 1	M10 X 1		
39509	MC39509	N/D	23.8 mm 15/16"	SEGUNDA	2	M10 X 1	M10 X 1		
39510	MC39510	N/D	23.8 mm 15/16"	TERCERA	2	M10 X 1	M10 X 1		
39518	MC39518	N/D	23.8 mm 15/16"	TERCERA	2	M10 X 1	M10 X 1		
39540	MC39540	N/D	23.8 mm 15/16"	TERCERA	4	9/16 X 18	3/8 X 24	3/8 X 24	M18 X 1
39547	MC39547	N/D	20.6 mm 13/16"	TERCERA	4	M10 X 1	M10 X 1	M20 X 1	M20 X 1
39553	MC39553	N/D	20.6 mm 13/16"	TERCERA	4	M10 X 1	M10 X 1	M10 X 1	M10 X 1
39555	MC39555	681	19.0 y 23.8 mm	CUARTA	2	M10 X 1	M10 X 1		
39565	MC39565	N/D	24.0 y 31.7 mm	CUARTA	4	M12 X 1	M12 X 1	M16 X 1.5	M16 X 1.5
39566	MC39566	N/D	28.6 y 40.0 mm	CUARTA	4	M12x1	M11x1.5	M16 X 1.5	M16 X 1.5
39567	MC39567	N/D	23.8 mm 15/16"	TERCERA	2	9/16" X 18	7/16" X 24		
39568	MC39568	N/D	23.8 mm 15/16"	CUARTA	4	1/2 X 20	3/8 X 24		
39571	MC39571	107051	24.0 y 36.0 mm	CUARTA	2	9/16" X 18	1/2" X 20		
39581	MC39581	N/D	24.0 y 31.7 mm	CUARTA	2	9/16 X 18	1/2 X 20		
39590	MC39590	N/D	22.2 mm 7/8"	CUARTA	2	M10 X 1	M10 X 1		
39591	MC39591	N/D	23.8 mm 15/16"	TERCERA	2	M10x1	M10 X 1		
39592	MC39592	N/D	23.8 mm 15/16"	TERCERA	2	M10 X 1	N/D		
39593	MC39593	N/D	25.4 mm 1"	TERCERA	4	M10 X 1	M10 X 1		
39594	MC39594	N/D	23.8 mm 15/16"	TERCERA	3	M10 X 1	M10 X 1	M10 X 1	
39596	MC39596	N/D	23.8 mm 15/16"	TERCERA	3	M10 X 1	M10 X 1	M10 X 1	
39599	MC39599	N/D	19.0 mm 3/4"	TERCERA	4	M10 X 1	M10 X 1	M10 X 1	M10 X 1
39600	MC39600	N/D	23.8 mm 15/16"	TERCERA	3	M10 X 1	M10 X 1	M10 X 1	
39606	MC39606	N/D	25.4 mm 1"	TERCERA	4	M10 X 1	M10 X 1	M10 X 1	M10 X 1
39609	MC39609	N/D	25.4 mm 1"	TERCERA	2	M10 X 1	M10 X 1		
39612	MC39612	N/D	23.8 mm 15/16"	TERCERA	2	M10 X 1	M10 X 1		
39632	MC39632	N/D	25.4 mm 1"	CUARTA	2	M18 X 1.5	9/16 X 18		
39635	MC39635	114085	28.5 mm 1-1/8"	TERCERA	2	M 18 X 1.5	9/16" X 18		
39638	MC39638	N/D	24.0 mm	TERCERA	2	9/16 X 20	9/16 X 20	1/2 X 20	1/2 X 20
39639	MC39639	N/D	20.6 mm 13/16"	TERCERA	2	M10 X 1	M10 X 1		
39640	MC39640	N/D	23.8 mm 15/16"	TERCERA	2	M10 X 1	M10 X 1		
39643	MC39643	N/D	22.2 mm 7/8"	TERCERA	4	M10 X 1	M10 X 1	M20 X 1	M20 X 1
39646	MC39646	1737	28.6 y 40.0 mm	CUARTA	2	9/16" X 18	1/2" X 20		
39648	MC39648	N/D	20.6 mm 13/16"	TERCERA	2	M10 X 1	M10 X 1		

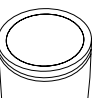

Medidas y especificaciones



CILINDROS MAESTROS

No PARTE LUSAC	No PARTE RAYBESTOS	No REPTO LUSAC	MEDIDA	GEN	NO. DE CONEX	DIÁM. DE CONEX. 1	DIÁM. DE CONEX. 2	DIÁM. DE CONEX. 3	DIÁM. DE CONEX. 4
39649	MC39649	39650	31.7 mm 1-1/4"	CUARTA	2	9/16" X 18	1/2" X 20		
39651	MC39651	N/D	25.4 y 36.0mm	CUARTA	2	9/16 X 18	1/2 X 20		
39653	MC39653	N/D	22.2 mm 7/8"	TERCERA	2	M10 X 1	M10 X 1		
39654	MC39654	N/D	22.2 mm 7/8"	TERCERA	3	M10 X 1	M10 X 1	M10 X 1	
39657	MC39657	N/D	22.2 mm 7/8"	TERCERA	2	M10 X 1	M10 X 1		
39658	MC39658	N/D	23.8 mm 15/16"	TERCERA	2	M10 X 1	M10 X 1		
39666	MC39666	N/D	22.2 mm 7/8"	TERCERA	2	M10 X 1	M10 X 1		
39669	MC39669	N/D	23.8 mm 15/16"	TERCERA	2	M10 X 1	M10 X 1		
39676	MC39676	191	20.0 mm	TERCERA	4	M12x1	M12x1	M12x1	M12x1
39699	MC39699	N/D	20.6 mm 13/16"	TERCERA	2	M10 X 1	M10 X 1		
39703	MC39703	N/D	19.0 y 23.8 mm	TERCERA	3	M10 X 1	M10 X 1	M10 X 1	
39704	MC39704	N/D	3/4" y 1"	TERCERA	3	M10 X 1	M10 X 1	M10 X 1	
39716	MC39716	N/D	22.2 mm 7/8"	TERCERA	2	M12x1	M10x1		
39720	MC39720	N/D	19.0 mm 3/4"	TERCERA	2	M10 X 1	M10 X 1		
39735	MC39735	N/D	25.4 mm 1"	TERCERA	4	M10 X 1	M10 X 1	M10 X 1	M16 X 1
39736	MC39736	116612	22.2 mm 7/8"	TERCERA	2	3/8" X 24	3/8" X 24		
39743	MC39743	N/D	22.2 mm 7/8"	TERCERA	2	M10 X 1	M10 X 1		
39745	MC39745	114196	24.0 mm	TERCERA	4	M12 X 1	M10 X 1	M11 X 1.5	M13 X 1.5
39748	MC39748	N/D	23.8 mm 15/16"	TERCERA	2	M10 X 1	M10 X 1		
39757	MC39757	N/D	22.2 mm 7/8"	TERCERA	2	M10 X 1	M10 X 1		
39765	MC39765	N/D	25.4 mm 1"	TERCERA	2	M10 X 1	M10 X 1		
39772	MC39772	120797	23.8 mm 15/16"	TERCERA	4	M12 X 1	M12 X 1	M10 X 1	M10 X 1
39782	MC39782	N/D	25.4 mm 1"	TERCERA	2	M10 X 1	M10 X 1		
39786	MC39786	N/D	23.8 mm 15/16"	TERCERA	2	M10 X 1	M10 X 1		
39791	MC39791	N/D	23.8 mm 15/16"	TERCERA	3	M10 X 1	M10 X 1	M10 X 1	
39795	MC39795	N/D	23.8 mm 15/16"	TERCERA	3	M10 X 1	M10 X 1	M10 X 1	
39797	MC39797	N/D	23.8 mm 15/16"	TERCERA	4	M10 X 1	M10 X 1	M10 X 1	M10 X 1
39799	MC39799	N/D	25.4 mm 1"	TERCERA	2	M10 X 1	M10 X 1		
39800	MC39800	N/D	23.8 mm 15/16"	TERCERA	2	M10 X 1	M10 X 1		
39805	MC39805	N/D	20.6 y 25.4mm	TERCERA	4	M10 X 1	M10 X 1	M10 X 1	M10 X 1
39810	MC39810	N/D	22.2 mm 7/8"	TERCERA	3	M10 X 1	M10 X 1	M10 X 1	
39812	MC39812	N/D	20.6 mm 13/16"	TERCERA	3	M10 X 1	M10 X 1	M10 X 1	
39853	MC39853	N/D	20.6 mm 13/16"	TERCERA	2	M10 X 1	M10 X 1		
39862	MC39862	N/D	28.5 mm 1-1/8"	TERCERA	2	9/16 X 20	1/2 X 20		
39876	MC39876	N/D	33.3 mm 1-5/16"	TERCERA	2	7/16 X 24	9/16 X 18		
39882	MC39882	N/D	23.8 mm 15/16"	TERCERA	2	M10 X 1	M10 X 1		
39947	MC39947	N/D	22.2 mm 7/8"	TERCERA	3	M10 X 1	M10 X 1	M10 X 1	
39949	MC39949	N/D	22.2 mm 7/8"	TERCERA	3	M10 X 1	M10 X 1	M10 X 1	
39950	MC39950	N/D	22.2 mm 7/8"	TERCERA	3	M10 X 1	M10 X 1	M10 X 1	
39952	MC39952	N/D	28.6 y 40.0 mm	CUARTA	2	M10 X 1	M10 X 1		
39953	MC39953	9953	25.4 mm 1"	TERCERA	2	M12 X 1	M10 X 1		
39954	MC39954	N/D	25.4 mm 1"	CUARTA	2	M12 X 1	M10 X 1		
39955	MC39955	N/D	25.4 mm 1"	TERCERA	2	M12 X 1	M10 X 1		
39956	MC39956	N/D	25.4 mm 1"	TERCERA	3	M10 X 1	M10 X 1	M10 X 1	
39960	MC39960	N/D	22.2 mm 7/8"	TERCERA	3	M10 X 1	M10 X 1	M10 X 1	
39962	MC39962	N/D	25.4 mm 1"	TERCERA	2	M12 X 1	M11 X 1.5		
39964	MC39964	N/D	33.3 mm 1-5/16"	TERCERA	2	9/16 X 18	1/2 X 20		
39968	MC39968	N/D	23.8 mm 15/16"	TERCERA	2	M10 X 1	M10 X 1		
39970	MC39970	N/D	25.4 mm 1"	TERCERA	2	M10 X 1	M12 X 1		
39973	MC39973	N/D	22.2 mm 7/8"	TERCERA	2	M10 X 1	M10 X 1		
39976	MC39976	N/D	25.4 mm 1"	TERCERA	3	M10 X 1	M10 X 1	M10 X 1	
39977	MC39977	N/D	25.4 mm 1"	TERCERA	3	M10 X 1	M10 X 1	M10 X 1	
39978	MC39978	N/D	25.4 mm 1"	TERCERA	3	M10 X 1	M10 X 1	M10 X 1	
39979	MC39979	N/D	23.8 mm 15/16"	TERCERA	3	M10 X 1	M10 X 1	M10 X 1	
39980	MC39980	N/D	25.4 mm 1"	TERCERA	2	7/16" X 24	1/2" X 20		
39981	MC39981	N/D	23.8 mm 15/16"	TERCERA	2	7/16" X 24	1/2" X 20		
39988	MC39988	N/D	25.4 mm 1"	TERCERA	2	M10 X 1	M10 X 1		

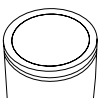



Medidas y especificaciones

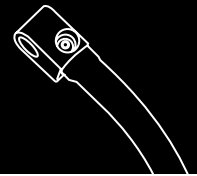
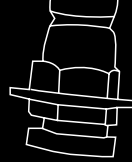

CILINDROS MAESTROS									
No PARTE LUSAC	No PARTE RAYBESTOS	No REPTO LUSAC	MEDIDA	GEN	NO. DE CONEX	DIÁM. DE CONEX. 1	DIÁM. DE CONEX. 2	DIÁM. DE CONEX. 3	DIÁM. DE CONEX. 4
39989	MC39989	N/D	23.8 mm 15/16"	TERCERA	2	M10 X 1	M10 X 1		
39993	MC39993	N/D	22.2 mm 7/8"	TERCERA	2	M10 X 1	M10 X 1		
39996	MC39996	N/D	25.4 mm 1"	TERCERA	2	M10 X 1	M10 X 1		
40000	MC36006	31066	25.4 mm 1"	SENCILLO	2	7/16" X 24	7/16" X 24		
42194	MC36127	19432	38.1 mm 1-1/2"	SENCILLO	1	1/2" X 20			
43207	MC34330	39142	25.4 mm 1"	SENCILLO	2	7/16" X 24	1/4" X 18 NPT		
56193	MC36237	59170	25.4 mm 1"	PRIMERA	2	1/2" X 20	1/8" X 27 NPT		
57597	MC36289	59000	31.7 mm 1-1/4"	SENCILLO	1	1/2" X 20			
64824	MC36231	59029	23.8 mm 15/16"	PRIMERA	2	9/16" X 18	1/2" X 20		
64859	MC36355	59039	28.5 mm 1-1/8"	PRIMERA	2	9/16" X 18	1/2" X 20		
64885	MC36239	59067	25.4 mm 1"	PRIMERA	2	9/16" X 18	1/2" X 20		
64986	MC36233	59070	25.4 mm 1"	PRIMERA	2	9/16" X 18	1/2" X 20		
66857	MC36246	59091	28.5 mm 1-1/8"	PRIMERA	2	9/16" X 18	1/2" X 20		
71245	MC36277	59048	25.4 mm 1"	SEGUNDA	2	3/8" X 24	7/16" X 24	9/16" X 18	
71248	MC36251	59182	25.4 mm 1"	SEGUNDA	2	3/8" X 24	1/2" X 20		
71258	MC36221	59051	25.4 mm 1"	PRIMERA	2	1/2" X 20	9/16" X 20		
71259	MC36258	59193	28.5 mm 1-1/8"	PRIMERA	2	1/2" X 20	9/16" X 18		
71260	MC36359	59192	31.7 mm 1-1/4"	PRIMERA	2	1/2" X 20	9/16" X 18		
71264	MC39468	71506	25.4 mm 1"	PRIMERA	2	9/16" X 18	1/2" X 20		
71265	MC39469	71507	25.4 mm 1"	PRIMERA	2	1/2" X 20	9/16" X 18		
71268	MC36356	71502	28.5 mm 1-1/8"	PRIMERA	2	9/16" X 18	9/16" X 18		
71273	MC36354	71505	28.5 mm 1-1/8"	PRIMERA	2	9/16" X 18	9/16" X 18		
71277	MC36235	85598	25.4 mm 1"	TERCERA	2	1/2" X 20	9/16" X 18		
73323	MC36222	71509	25.4 mm 1"	PRIMERA	2	1/2" X 20	9/16" X 18		
73328	MC39495	71594	25.4 mm 1"	PRIMERA	2	1/2" X 20	9/16" X 18		
73333	MC36386	71612	25.4 mm 1"	SEGUNDA	2	1/2" X 20	1/2" X 20		
73339	MC36359	59193	31.7 mm 1-1/4"	PRIMERA	2	1/2" X 20	9/16" X 18		
73342	MC36280	71596	28.5 mm 1-1/8"	TERCERA	2	1/2" X 20	9/16" X 18		
73343	MC36317	71596	28.5 mm 1-1/8"	TERCERA	2	1/2" X 20	9/16" X 18		
75818	MC36307	71664	26.1 mm 1-1/32"	SEGUNDA	2	9/16" X 20	9/16" X 20		
75819	MC36426	71664	26.1 mm 1-1/32"	SEGUNDA	2	9/16" X 20	9/16" X 20		
76160	MC36361	71683	28.5 mm 1-1/8"	TERCERA	2	1/2" X 20	9/16" X 18		
76164	MC36407	71685	28.5 mm 1-1/8"	SEGUNDA	2	1/2" X 20	9/16" X 18		
76165	MC36456	71686	26.9 mm 1-1/16"	SEGUNDA	2	1/2" X 20	1/2" X 20		
77763	MC36492	D3TZ-2004	38.1 mm 1-1/2"	SENCILLO	1	1/2" X 20			
78672	MC36333	78673	23.8 mm 15/16"	TERCERA	2	7/16" X 24	9/16" X 18		
78676	MC39467	98909	25.4 mm 1"	TERCERA	2	1/2" X 20	7/16" X 24		
79772	MC36338	79773	23.8 mm 15/16"	PRIMERA	2	1/2" X 20	9/16" X 18		
80266	MC36406	80267	23.8 mm 15/16"	SEGUNDA	2	1/2" X 20	9/16" X 20		
80293	MC36424	80265	25.4 mm 1"	TERCERA	2	1/2" X 20	9/16" X 18		
80568	MC36461	80569	28.5 mm 1-1/8"	SEGUNDA	2	1/2" X 20	9/16" X 18		
80903	MC36397	80904	25.4 mm 1"	TERCERA	2	1/2" X 20	9/16" X 18		
83575	MC36399	88631	25.4 mm 1"	TERCERA	2	1/2" X 20	7/16" X 24		
83578	MC36439	71664	26.1 mm 1-1/32"	PRIMERA	2	1/2" X 20	9/16" X 20		
83746	MC36446	83747	23.8 mm 15/16"	TERCERA	2	7/16" X 24	1/2" X 20		
84050	MC39177	84051	25.4 mm 1"	TERCERA	2	1/2" X 20	9/16" X 20		
85365	MC36440	85366	23.8 mm 15/16"	TERCERA	2	9/16" X 18	7/16" X 24		
85949	MC36468	88715	28.5 mm 1-1/8"	TERCERA	2	1/2" X 20	9/16" X 18		
86130	MC36445	86508	23.8 mm 15/16"	TERCERA	2	7/16" X 24	3/8" X 24		
88783	MC36460	80582	26.1 mm 1-1/32"	TERCERA	2	9/16" X 20	1/2" X 20		
88787	MC36412	71664	26.1 mm 1-1/32"	SEGUNDA	2	9/16" X 20	1/2" X 20		
88788	MC36489	89036	26.1 mm 1-1/32"	TERCERA	2	9/16" X 20	1/2" X 20		
90547	MC36272	130	17.4 mm 11/16"	SENCILLO	3	M10 X 1	M10 X 1	M10 X 1	
93065	MC35125	33118	19.0 mm 3/4"	SENCILLO	3	M10 X 1	M10 X 1	M10 X 1	
96409	MC39147	196	20.6 mm 13/16"	TERCERA	4	M10 X 1	M10 X 1	M10 X 1	M10 X 1
96415	MC36275	96416	19.0 mm 3/4"	TERCERA	3	M10X1	M10X1	M10X1	
96431	MC39377	195	17.4 mm 11/16"	TERCERA	4	M10 X 1	M10 X 1	M10 X 1	M10 X 1

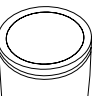

Medidas y especificaciones



CILINDROS MAESTROS

No PARTE LUSAC	No PARTE RAYBESTOS	No REPTO LUSAC	MEDIDA	GEN	NO. DE CONEX	DIÁM. DE CONEX. 1	DIÁM. DE CONEX. 2	DIÁM. DE CONEX. 3	DIÁM. DE CONEX. 4
97071	MC39677	152	23.8 mm 15/16"	TERCERA	2	M10 X 1	M10 X 1		
97742	MC39809	98678	26.9 mm 1-1/16"	TERCERA	2	1/2" X 20	9/16" X 18		
97934	MC39011	97935	25.4 mm 1"	TERCERA	2	9/16" X 18	7/16" X 24		
97936	MC39368	99083	26.9 mm 1-1/16"	TERCERA	2	1/2" X 20	9/16" X 18		
97938	MC39116	99083	26.9 mm 1-1/16"	TERCERA	2	7/16" X 24	3/8" X 24		
98893	MC39031	97688	23.8 mm 15/16"	TERCERA	2	1/2" X 20	9/16" X 18		
98895	MC39178	101928	28.5 mm 1-1/8"	TERCERA	2	9/16" X 20	1/2" X 20		
98896	MC36463	86626	28.5 mm 1-1/8"	TERCERA	2	1/2" X 20	9/16" X 18		
98953	MC39017	86511	33.3 mm 1-5/16"	TERCERA	2	1/2" X 20	9/16" X 18		
99084	MC39037	99085	22.2 mm 7/8"	TERCERA	2	7/16" X 24	1/2" X 20		
99086	MC39174	99087	22.2 mm 7/8"	TERCERA	2	7/16" X 24	1/2" X 20		
99294	MC39034	99296	26.1 mm 1-1/32"	TERCERA	2	9/16" X 20	1/2" X 20		
100560	MC36229	59012	38.1 mm 1-1/2"	SENCILLO	1	1/2" X 20			
100756	MC39171	100757	22.2 mm 7/8"	PRIMERA	2	M10 X 1.25	M10 X 1.25		
100760	MC36494	100761	19.0 mm 3/4"	PRIMERA	2	M10 X 1.25	M10 X 1.25		
101252	MC39166	99101	22.2 mm 7/8"	TERCERA	2	1/2" X 20	9/16" X 18		
101253	MC39016	99032	23.8 mm 15/16"	TERCERA	2	9/16" X 20	1/2" X 20		
101254	MC36306	97613	28.5 mm 1-1/8"	TERCERA	2	9/16" X 20	1/2" X 20		
101255	MC39023	97680	25.4 mm 1"	TERCERA	2	1/2" X 20	9/16" X 18		
101258	MC39028	97613	28.5 mm 1-1/8"	TERCERA	2	9/16" X 18	1/2" X 20		
101266	MC39075	98059	31.7 mm 1-1/4"	TERCERA	2	9/16" X 18	1/2" X 20		
101268	MC39077	97613	28.5 mm 1-1/8"	TERCERA	2	1/2" X 20	9/16" X 18		
101269	MC39076	97612	28.5 mm 1-1/8"	TERCERA	2	1/2" X 20	9/16" X 18		
102165	MC39233	102166	22.2 mm 7/8"	SEGUNDA	2	M10 X 1	M10 X 1		
102418	MC39357	102419	25.4 mm 1"	TERCERA	2	1/2" X 20	7/16" X 24		
102420	MC39172	99083	26.9 mm 1-1/16"	TERCERA	2	1/2" X 20	9/16" X 18		
102421	MC39173	99083	26.9 mm 1-1/16"	TERCERA	2	3/8" X 24	7/16" X 24		
103238	MC39309	105838	34.0 mm	TERCERA	2	1/2" X 20	9/16" X 18		
103254	MC39461	103255	38.1 mm 1-1/2"	SENCILLO	1	1/2" X 20			
104460	MC39328	104459	28.6 y 40.0 mm	CUARTA	2	1/2" X 20	9/16" X 18		
104464	MC39324	104465	31.7 mm 1-1/4"	CUARTA	2	9/16" X 18	1/2" X 20		
104466	MC39589	104467	25.4 y 36.0mm	CUARTA	2	1/2" X 20	9/16" X 18		
104471	MC39312	104472	21.0 mm	TERCERA	2	9/16" X 18	7/16" X 24		
104473	MC39310	104474	21.0 mm	TERCERA	2	9/16" X 18	7/16" X 24		
104516	MC39223	104459	28.6 y 40.0 mm	CUARTA	2	9/16" X 18	1/2" X 20		
105799	MC39570	105803	24.0 y 31.7 mm	CUARTA	2	9/16" X 18	1/2" X 20		
105808	MC39350	105809	21.0 mm	TERCERA	2	9/16" X 18	1/2" X 20		
105872	MC39365	N/D	25.4 mm 1"	TERCERA	2	M18 X 1.5	9/16" X 18		
105874	MC39367	105875	25.4 mm 1"	TERCERA	2	1/2" X 20	9/16" X 18		
106437	MC39014	98509	31.7 mm 1-1/4"	TERCERA	2	9/16" X 18	1/2" X 20		
107050	MC39376	107051	24.0 y 36.0 mm	CUARTA	2	1/2" X 20	9/16" X 18		
107053	MC39375	107054	22.2 mm 7/8"	TERCERA	2	1/2" X 20	9/16" X 18		
107078	MC39327	104470	22.2 mm 7/8"	TERCERA	2	3/8" X 24	3/8" X 24		
108134	MC39451	112115	21.0 mm	TERCERA	2	3/8" X 24	3/8" X 24		
108145	MC39435	113441-A	33.3 mm 1-5/16"	TERCERA	2	9/16" X 18	1/2" X 20		
108151	MC39443	108657	20.0 mm	CUARTA	4	M12 X 1	M10 X 1	M18 X 1.5	M16 X 1.5
108161	MC39448	108162	23.8 mm 15/16"	TERCERA	2	1/2" X 20	9/16" X 18		
108168	MC39476	112246	24.0 mm	TERCERA	2	3/8" X 24	3/8" X 24		
108700	MC39440	107056	24.0 y 31.7 mm	CUARTA	4	M12 X 1	M11 X 1.5	M16 X 1.5	M16 X 1.5
110887	MC39578	113440	28.6 y 40.0 mm	CUARTA	2	1/2" X 20	9/16" X 18		
110917	MC39446	110918	26.9 mm 1-1/16"	TERCERA	2	1/2" X 20	9/16" X 18		
110919	MC39445	110920	28.5 mm 1-1/8"	TERCERA	2	3/8" X 24	7/16" X 24		
110983	MC39655	194	20.6 mm 13/16"	TERCERA	4	M10 X 1	M10 X 1	M10 X 1	M10 X 1
112311	MC39531	112312	21.0 mm	TERCERA	2	1/2" X 20	9/16" X 18		
112590	MC39543	112592	22.2 mm 7/8"	CUARTA	4	M12 X 1	M10 X 1	M10 X 1	M12 X 1
112591	MC39542	112592	22.2 mm 7/8"	CUARTA	4	M12 X 1	M10 X 1	M16 X 1.5	M18 X 1.5
114075	MC39628	112594	23.8 mm 15/16"	TERCERA	2	9/16" X 18	7/16" X 24		

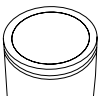



Medidas y especificaciones

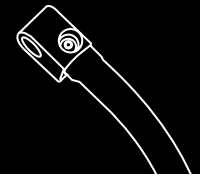
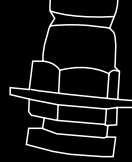

CILINDROS MAESTROS									
No PARTE LUSAC	No PARTE RAYBESTOS	No REPTO LUSAC	MEDIDA	GEN	NO. DE CONEX	DIÁM. DE CONEX. 1	DIÁM. DE CONEX. 2	DIÁM. DE CONEX. 3	DIÁM. DE CONEX. 4
114079	MC39636	114085	28.5 mm 1-1/8"	CUARTA	2	9/16" X 18	M18 X 1.5		
114081	MC39633	116611	23.8 mm 15/16"	CUARTA	2	9/16" X 18	M18 X 1.5		
114190	MC39583	114191	22.2 mm 7/8"	TERCERA	4	M12 X 1	M11 X 1.5	M10 X 1	M13 X 1.5
114192	MC39585	114196	24.0 mm	TERCERA	4	M12 X 1	M11 X 1.5	M10 X 1	M13 X 1.5
114195	MC39584	114196	24.0 mm	TERCERA	4	M12 X 1	M11 X 1.5	M10 X 1	M13 X 1.5
116402	MC39363	99984	22.2 mm 7/8"	CUARTA	4	M12 X 1	M11 X 1.5	M18 X 1.5	M20 X 1.5
116403	MC39382	99984	22.2 mm 7/8"	CUARTA	4	M12 X 1	M11 X 1.5	M16 X 1.5	M16 X 1.5
116625	MC39647	107051	24.0 y 36.0 mm	CUARTA	2	1/2" X 20	9/16" X 18		
116702	MC39528	108120	44.4 mm 1-3/4"	TERCERA	2	1/2" X 20	9/16" X 18		
117583	MC39637	117584	21.0 y 30.2 mm	CUARTA	3	M10 X 1	M10 X 1	M12 X 1	
119401	MC39462	108120	44.4 mm 1-3/4"	TERCERA	2	11/16" X 18	3/4" X 18		
120369	MC39634	114084	26.9 mm 1-1/16"	TERCERA	2	M18 X 1.5	9/16" X 18		
120590	MC39767	120591	31.7 mm 1-1/4"	TERCERA	2	1/2" X 20	9/16" X 18		
120794	MC39773	120795	23.8 mm 15/16"	TERCERA	4	M12 X 1	M10 X 1	M18 X 1	M16 X 1.5
122572	MC39958	120797	25.4 mm 1"	TERCERA	4	M16 X 1	M18 X 1	M12 X 1	M10 X 1
390004	MC390004	N/D	20.6 mm 13/16"	TERCERA	4	M10 X 1	M10 X 1	M10 X 1	M10 X 1
390006	MC390006	693	19.0 mm 3/4"	TERCERA	4	M10 X 1	M10 X 1	M10 X 1	M10 X 1
390007	MC390007	N/D	19.0 mm 3/4"	TERCERA	2	M10 X 1	M10 X 1		
390018	MC390018	N/D	23.8 mm 15/16"	TERCERA	4	M10 X 1	M10 X 1	M10 X 1	M10 X 1
390024	MC390024	N/D	25.4 mm 1"	TERCERA	2	M10 X 1	M10 X 1		
390029	MC390029	N/D	22.2 mm 7/8"	TERCERA	2	M10 X 1	M10 X 1		
390038	MC390038	N/D	25.4 mm 1"	TERCERA	3	M10 X 1	M10 X 1	M10 X 1	
390039	MC390039	N/D	23.8 mm 15/16"	TERCERA	3	M10 X 1	M10 X 1	M10 X 1	
390044	MC390044	N/D	23.8 mm 15/16"	TERCERA	2	M10x1	M12x1		
390049	MC390049	N/D	25.4 mm 1"	TERCERA	4	M10 X 1	M10 X 1	M12 X 1	M12 X 1
390056	MC390056	N/D	25.4 mm 1"	CUARTA	2	M10 X 1	M10 X 1		
390060	MC390060	90060	20.6 mm 13/16"	TERCERA	4	M10 X 1	M10 X 1	M10 X 1	M10 X 1
390063	MC390063	N/D	28.6 y 40.0 mm	CUARTA	2	9/16 X 18	1/2 X 20		
390071	MC390071	N/D	25.4 mm 1"	TERCERA	4	M10 X 1	M10 X 1	M12 X 1	M12 X 1
390073	MC390073	N/D	23.8 mm 15/16"	TERCERA	2	M10 X 1	M12 X 1		
390096	MC390096	N/D	26.9 mm 1-1/16"	TERCERA	2	38 X 24	7/16" X 24		
390110	MC390110	128405	23.8 mm 15/16"	TERCERA	4	M10 X 1	M10 X 1	M11 X 1.5	M11 X 1.5
390111	MC390111	N/D	23.8 mm 15/16"	TERCERA	2	M12 X 1	M12 X 1		
390115	MC390115	N/D	25.4 mm 1"	TERCERA	2	M10 X 1	M10 X 1		
390116	MC390116	N/D	25.4 mm 1"	TERCERA	2	M10 X 1	M10 X 1		
390117	MC390117	N/D	28.5 mm 1-1/8"	TERCERA	4	7/16 X 24	7/16 X 24	9/16 X 18	9/16 X 18
390118	MC390118	N/D	25.4 mm 1"	TERCERA	3	M10 X 1	M10 X 1	M10 X 1	
390121	MC390121	N/D	23.8 mm 15/16"	TERCERA	4	M10 X 1	M10 X 1	M10 X 1	M10 X 1
390126	MC390126	N/D	26.9 mm 1-1/16"	TERCERA	4	M10 X 1	M10 X 1	M12 X 1	M12 X 1
390139	MC390139	N/D	23.8 mm 15/16"	TERCERA	4	M10 X 1	M10 X 1	M10 X 1	M10 X 1
390140	MC390140	N/D	23.8 mm 15/16"	TERCERA	4	M10 X 1	M10 X 1	M10 X 1	M10 X 1
390141	MC390141	N/D	25.4 mm 1"	TERCERA	2	M10 X 1	M10 X 1		
390156	MC390156	N/D	23.8 mm 15/16"	TERCERA	2	M10x1	Sin Rosca		
390161	MC390161	N/D	23.8 mm 15/16"	TERCERA	2	M10 X 1	M10 X 1		
390162	MC390162	N/D	25.4 mm 1"	TERCERA	2	M10 X 1	M10 X 1		
390170	MC390170	N/D	25.4 mm 1"	TERCERA	2	M10 X 1	M10 X 1		
390174	MC390174	114191	22.2 mm 7/8"	TERCERA	4	M10 X 1	M10 X 1	UNTHDD	UNTHDD
390175	MC390175	114196	24.0 mm	TERCERA	4	M10 X 1	M10 X 1	M10 X 1	M10 X 1
390176	MC390176	N/D	24.0 mm	TERCERA	4	M12 X 1	M12 X 1	M11 X 1.5	M11 X 1.5
390178	MC390178	114496	24.0 mm	TERCERA	4	M10 X 1	M10 X 1	UNTHDD	UNTHDD
390179	MC390179	1831	24.0 mm	TERCERA	4	M10 X 1	M10 X 1	UNTHDD	UNTHDD
390182	MC390182	114085	28.5 mm 1-1/8"	TERCERA	4	7/16" X 24	7/16" X 24	9/16" X 18	9/16" X 18
390183	MC390183	114084	28.5 mm 1-1/8"	TERCERA	4	M19 X 1.5	9/16" X 20	3/8 " X 24	
390184	MC390184	114085	28.5 mm 1-1/8"	TERCERA	4	7/16" X 24	7/16" X 24	9/16" X 18	9/16" X 18
390185	MC390185	90185	26.9 mm 1-1/16"	TERCERA	4	M10 X 1	M10 X 1	M12 X 1	M12 X 1
390186	MC390186	N/D	25.4 mm 1"	TERCERA	4	M10 X 1	M10 X 1	M12 X 1	M12 X 1
390188	MC390188	N/D	24.0 mm	TERCERA	4	9/16 20	9/16 20	1/2 X 20	1/2 X 20

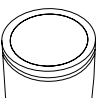

Medidas y especificaciones



CILINDROS MAESTROS

No PARTE LUSAC	No PARTE RAYBESTOS	No REPTO LUSAC	MEDIDA	GEN	NO. DE CONEX	DIÁM. DE CONEX. 1	DIÁM. DE CONEX. 2	DIÁM. DE CONEX. 3	DIÁM. DE CONEX. 4
390190	MC390190	N/D	31.7 mm 1-1/4"	TERCERA	2	9/16" X 20	9/16" X 20	1/2" X 20	1/2" X 20
390204	MC390204	90203	21.0 mm	TERCERA	4	7/16" X 24	7/16" X 24	3/8" X 24	3/8" X 24
390205	MC390205	N/D	21.0 mm	TERCERA	4	7/16" X 24	7/16" X 24	3/8" X 24	3/8" X 24
390213	MC390213	90204	22.2 mm 7/8"	TERCERA	4	7/16" X 24	7/16" X 24	3/8" X 24	3/8" X 24
390214	MC390214	N/D	25.4 mm 1"	TERCERA	2	M10 X 1	M10 X 1		
390215	MC390215	90215	22.2 mm 7/8"	TERCERA	4	7/16 X 24	7/16 X 24	7/16 X 24	7/16 X 24
390216	MC390216 / MC39880	N/D	26.9 mm 1-1/16"	TERCERA	2	3/8 " X 24	7/16" X 24		
390217	MC390217	N/D	23.8 mm 15/16"	TERCERA	2	M10 X 1	M10 X 1		
390224	MC390224	N/D	23.8 mm 15/16"	TERCERA	4	M10x1	M10x1	M10x1	M10x1
390225	MC390225	N/D	23.8 mm 15/16"	TERCERA	4	M10 X 1	M10 X 1	M10 X 1	M10 X 1
390226	MC390226	N/D	25.4 mm 1"	TERCERA	2	M10 X 1	M12 X 1		
390231	MC390231	N/D	23.8 mm 15/16"	TERCERA	2	M10 X 1	M10 X 1		
390233	MC390233	N/D	23.8 mm 15/16"	CUARTA	2	M10 X 1	M10 X 1		
390234	MC390234	90234	23.8 mm 15/16"	TERCERA	4	M10 X 1	M10 X 1	M10 X 1	M10 X 1
390235	MC390235	N/D	23.8 mm 15/16"	TERCERA	4	M10 X 1	M10 X 1	M10 X 1	M10 X 1
390236	MC390236	N/D	26.9 mm 1-1/16"	TERCERA	2	M10 X 1	M10 X 1		
390239	MC390239	N/D	23.8 mm 15/16"	TERCERA	2	M10 X 1	M10 X 1		
390244	MC390244	N/D	1" y 13/16"	TERCERA	2	M10 X 1	M10 X 1		
390245	MC390245	N/D	25.4 mm 1"	TERCERA	4	M10 X 1	M10 X 1	M12 X 1	M12 X 1
390248	MC390248	N/D	26.9 mm 1-1/16"	TERCERA	3	M10 X 1	M10 X 1	3/8 " X 24	
390251	MC390251	90251	22.2 mm 7/8"	TERCERA	4	7/16" X 24	7/16" X 24	3/8 " X 24	3/8 " X 24
390253	MC390253	N/D	44.4 mm 1-3/4"	TERCERA	2	9/16 X 18	1/2 X 20		
390254	MC390254	N/D	22.2 mm 7/8"	TERCERA	2	7/16" X 24	3/8 " X 24		
390255	MC390255	N/D	23.8 mm 15/16"	TERCERA	2	M10x1	M12x1		
390256	MC390256	N/D	25.4 mm 1"	TERCERA	4	M10 X 1	M10 X 1	M12 X 1	M12 X 1
390257	MC390257	39650	31.7 mm 1-1/4"	CUARTA	2	9/16" X 20	9/16" X 20	1/2" X 20	1/2" X 20
390258	MC390258	N/D	31.7 mm 1-1/4"	CUARTA	4	9/16" X 20	9/16" X 20	1/2" X 20	1/2" X 20
390259	MC390259	104459	40.0 y 28.5 mm	CUARTA	4	9/16" X 20	9/16" X 20	1/2" X 20	1/2" X 20
390267	MC390267	N/D	25.4 mm 1"	TERCERA	2	M12 X 1	M10 X 1		
390268	MC390268	N/D	26.9 mm 1-1/16"	TERCERA	2	M12 X 1	M10 X 1		
390269	MC390269	N/D	26.9 mm 1-1/16"	TERCERA	2	M12 X 1	M10 X 1		
390271	MC390271	90271	22.2 mm 7/8"	TERCERA	3	M10 X 1	M10 X 1	M10 X 1	
390275	MC390275	N/D	23.8 mm 15/16"	TERCERA	2	7/16" X 24	7/16" X 24		
390276	MC390276	N/D	22.2 mm 7/8"	TERCERA	2	M10 X 1	M10 X 1		
390277	MC390277	114191	22.2 mm 7/8"	TERCERA	2	M10 X 1	M10 X 1		
390278	MC390278	N/D	40.0 mm	TERCERA	2	9/16 X 18	1/2 X 20		
390279	MC390279	90279	31.7 mm 1-1/4"	CUARTA	2	9/16" X 18	1/2" X 20		
390285	MC390285	N/D	25.4 mm 1"	CUARTA	2	M10 X 1	M10 X 1		
390289	MC390289	N/D	25.4 mm 1"	TERCERA	2	M10 X 1	M10 X 1		
390291	MC390291	N/D	25.4 mm 1"	TERCERA	2	M10x1	M10 X 1		
390296	MC390296	N/D	25.4 mm 1"	CUARTA	2	M10 X 1	M10 X 1		
390298	MC390298	N/D	25.4 mm 1"	TERCERA	2	M12 X 1	M10 X 1		
390299	MC390299	N/D	25.4 mm 1"	TERCERA	2	M10 X 1	M12 X 1		
390303	MC390303	90303	25.4 mm 1"	TERCERA	2	M10 X 1	M12 X 1		
390308	MC390308	N/D	25.4 mm 1"	TERCERA	2	M10 X 1	M12 X 1		
390309	MC390309	N/D	25.4 mm 1"	TERCERA	2	M12 X 1	M12 X 1		
390310	MC390310	N/D	25.4 mm 1"	TERCERA	2	M10 X 1	M12 X 1		
390313	MC390313	N/D	26.9 mm 1-1/16"	TERCERA	2	M10 X 1	M12 X 1		
390314	MC390314	N/D	26.9 mm 1-1/16"	TERCERA	2	M10 X 1	M12 X 1		
390317	MC390317	694	20.6 mm 13/16"	TERCERA	4	M10 X 1	M10 X 1	M10 X 1	M10 X 1
390318	MC390318	90318	22.2 mm 7/8"	TERCERA	4	M10 X 1	M10 X 1	M10 X 1	M10 X 1
390319	MC390319	N/D	22.2 mm 7/8"	TERCERA	2	M10 X 1	M10 X 1		
390320	MC390320	N/D	36.0 y 24.0 mm	CUARTA	2	9/16 X 18	1/2 X 20		
390321	MC390321	N/D	31.7 mm 1-1/4"	TERCERA	2	9/16 X 18	1/2 X 20		
390323	MC390323	N/D	22.2 mm 7/8"	TERCERA	2	M10 X 1	M10 X 1		
390325	MC390325	N/D	50.8 mm 2"	TERCERA	2	9/16 X 18	1/2 X 20		

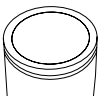



Medidas y especificaciones

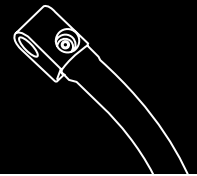
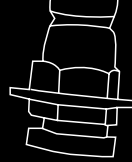

CILINDROS MAESTROS									
No PARTE LUSAC	No PARTE RAYBESTOS	No REPTO LUSAC	MEDIDA	GEN	NO. DE CONEX	DIÁM. DE CONEX. 1	DIÁM. DE CONEX. 2	DIÁM. DE CONEX. 3	DIÁM. DE CONEX. 4
390326	MC390326	N/D	23.8 mm 15/16"	TERCERA	2	M10 X 1	M10 X 1		
390328	MC390328	N/D	20.6 mm 13/16"	TERCERA	2	M10 X 1	M10 X 1		
390329	MC390329	N/D	26.9 mm 1-1/16"	TERCERA	3	M12 X 1	M12 X 1	3/8 X 24	
390331	MC390331	N/D	22.2 mm 7/8"	TERCERA	2	M10 X 1	M10 X 1		
390335	MC390335	N/D	23.8 mm 15/16"	TERCERA	3	M10 X 1	M10 X 1	M10 X 1	
390336	MC390336	N/D	31.7 mm 1-1/4"	TERCERA	2	M19 X 1.5	9/19" X 20		
390337	MC390337	90337	31.7 mm 1-1/4"	TERCERA	2	7/16" X 24	9/16" X 18		
390338	MC390338	N/D	31.7 mm 1-1/4"	TERCERA	2	M19 X 1.5	9/16" X 18	3/8" X 24	
390339	MC390339	N/D	31.7 mm 1-1/4"	TERCERA	2	7/16" X 24	9/16" X 18		
390342	MC390342	N/D	25.4 mm 1"	TERCERA	2	M10 X 1	M10 X 1		
390343	MC390343	N/D	25.4 mm 1"	TERCERA	2	M10 X 1	M10 X 1		
390344	MC390344	N/D	25.4 mm 1"	TERCERA	3	M10 X 1	M10 X 1	M10 X 1	
390347	MC390347	N/D	25.4 mm 1"	TERCERA	2	M10x1	M10x1		
390351	MC390351	N/D	22.2 mm 7/8"	TERCERA	2	M10x1	M10x1		
390362	MC390362	N/D	25.4 mm 1"	TERCERA	2	M10 X 1	M10 X 1		
390363	MC390363	N/D	28.5 mm 1-1/8"	TERCERA	2	9/16 X 18	1/2 X 20		
390364	MC390364	N/D	31.7 mm 1-1/4"	TERCERA	2	1/2 X 20	9/16 X 18		
390367	MC390367	N/D	25.4 mm 1"	TERCERA	2	M10x1	M10x1		
390368	MC390368	N/D	25.4 mm 1"	CUARTA	2	M10x1	M10x1		
390370	MC390370	N/D	25.4 mm 1"	TERCERA	2	M10 X 1	M12 X 1		
390371	MC390371	N/D	25.4 mm 1"	TERCERA	2	M10 X 1	M10 X 1	SIN ROSCA	SIN ROSCA
390377	MC390377	N/D	23.8 mm 15/16"	TERCERA	2	M12 X 1	M12 X 1		
390378	MC390378	N/D	25.4 mm 1"	TERCERA	2	M10 X 1	M12 X 1		
390386	MC390386	90386	25.4 mm 1"	TERCERA	2	M10 X 1	M10 X 1		
390389	MC390389	N/D	31.7 mm 1-1/4"	TERCERA	2	7/16" X 24	9/16" X 24		
390391	MC390391	N/D	31.7 mm 1-1/4"	TERCERA	2	7/16 X 24	9/16 X 18		
390392	MC390392	N/D	28.5 mm 1-1/8"	TERCERA	2	7/16" X 24	9/16" X 24		
390393	MC390393	N/D	28.5 mm 1-1/8"	TERCERA	2	7/16" X 24	9/16" X 24		
390394	MC390394	N/D	31.7 mm 1-1/4"	TERCERA	2	11/16" X 18	9/16" X 18		
390395	MC390395	N/D	25.4 mm 1"	TERCERA	3	M10 X 1	M10 X 1	3/8" X 24	
390398	MC390398	90398	26.9 mm 1-1/16"	TERCERA	2	M10 X 1	M12 X 1	3/8" X 24	
390399	MC390399	N/D	26.9 mm 1-1/16"	TERCERA	2	M10 X 1	M11 X 1	Purgador	
390400	MC390400	N/D	26.9 mm 1-1/16"	TERCERA	2	M10 X 1	M11 X 1		
390401	MC390401	N/D	25.4 mm 1"	TERCERA	2	M10 X 1	M10 X 1		
390406	MC390406	N/D	23.8 mm 15/16"	TERCERA	2	M10 X 1	M10 X 1		
390408	MC390408	N/D	26.9 mm 1-1/16"	TERCERA	2	M10 X 1	M12 X 1		
390417	MC390417	N/D	23.8 mm 15/16"	TERCERA	2	M10 X 1	M10 X 1		
390418	MC390418	N/D	25.4 mm 1"	TERCERA	2	M10 X 1	M10 X 1		
390419	MC390419	N/D	25.4 mm 1"	TERCERA	2	M12 X 1	M10 X 1		
390425	MC390425	N/D	22.2 mm 7/8"	TERCERA	2	7/16" X 24	7/16" X 24		
390426	MC390426	90426	31.7 mm 1-1/4"	TERCERA	2	M12 X 1	M10 X 1		
390427	MC390427	N/D	25.4 mm 1"	TERCERA	2	1/2 X 18	9/16 X 18		
390430	MC390430	N/D	25.4 mm 1"	TERCERA	2	M10 X 1	M12 X 1		
390432	MC390432	N/D	22.2 mm 7/8"	TERCERA	2	M10 X 1	M10 X 1		
390433	MC390433	N/D	25.4 mm 1"	TERCERA	2	M10 X 1	M10 X 1		
390440	MC390440	N/D	23.8 mm 15/16"	TERCERA	2	M12 X 1	M10 X 1		
390441	MC390441	N/D	25.4 mm 1"	TERCERA	2	M10 X 1	M10 X 1		
390445	MC390445	N/D	25.4 mm 1"	TERCERA	2	M12 X 1	M10 X 1		
390447	MC390447	N/D	23.8 mm 15/16"	TERCERA	4	M10 X 1	M10 X 1	M10 X 1	M10 X 1
390448	MC390448	N/D	23.8 mm 15/16"	TERCERA	2	M10 X 1	M10 X 1		
390449	MC390449	N/D	23.8 mm 15/16"	TERCERA	4	M10 X 1	M10 X 1	M10 X 1	M10 X 1
390450	MC390450	N/D	23.8 mm 15/16"	TERCERA	2	M10 X 1	M10 X 1		
390451	MC390451	N/D	25.4 mm 1"	TERCERA	2	M10 X 1	M10 X 1		
390455	MC390455	N/D	25.4 mm 1"	TERCERA	2	M19 X 1.5	M12 X 1		
390463	MC390463	90463	25.4 mm 1"	TERCERA	4	7/16 X 24	7/16 X 24	3/8 X 24	3/8 X 24
390465	MC390465	N/D	44.4 mm 1-3/4"	TERCERA	2	M10 X 1	M10 X 1		

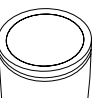

Medidas y especificaciones



CILINDROS MAESTROS

No PARTE LUSAC	No PARTE RAYBESTOS	No REPTO LUSAC	MEDIDA	GEN	NO. DE CONEX	DIÁM. DE CONEX. 1	DIÁM. DE CONEX. 2	DIÁM. DE CONEX. 3	DIÁM. DE CONEX. 4
390479	MC390479	N/D	23.8 mm 15/16"	TERCERA	2	M12 X 1	M10 X 1		
390480	MC390480	N/D	13/16" y 3/4"	CUARTA	2	M12 X 1	M10 X 1		
390483	MC390483	N/D	25.4 mm 1"	TERCERA	2	M10 X 1	M10 X 1		
390488	MC390488	N/D	23.8 mm 15/16"	TERCERA	2	M12 X 1	M10 X 1		
390491	MC390491	N/D	1" y 3/4"	TERCERA	2	M12 X 1	M10 X 1		
390500	MC390500	N/D	23.8 mm 15/16"	TERCERA	2	M12 X 1	M12 X 1		
390508	MC390508	N/D	23.8 mm 15/16"	TERCERA	2	M12 X 1	M10 X 1		
390514	MC390514	N/D	23.8 mm 15/16"	TERCERA	4	M10 X 1	M10 X 1	M10 X 1	M10 X 1
390515	MC390515	N/D	23.8 mm 15/16"	TERCERA	4	M10 X 1	M10 X 1	M10 X 1	M10 X 1
390516	MC390516	90516	31.7 mm 1-1/4"	TERCERA	2	M10 X 1	M12 X 1		
390521	MC390521	N/D	25.4 mm 1"	TERCERA	2	M10 X 1	M10 X 1		
390525	MC390525	N/D	25.4 mm 1"	TERCERA	2	M10 X 1	M10 X 1		
390526	MC390526	N/D	33.3 mm 1-5/16"	TERCERA	2	9/16 X 18	7/16 X 24		
390527	MC390527	N/D	26.9 mm 1-1/16"	TERCERA	2	M10 X 1	M10 X 1	Purgador	Purgador
390528	MC390528	N/D	26.9 mm 1-1/16"	TERCERA	2	M10 X 1	M12 X 1		
390530	MC390530	N/D	34.9 mm 1-3/8"	TERCERA	2	7/16" X 24	9/16 x 20	3/8 X 24	
390531	MC390531	90531	34.9 mm 1-3/8"	TERCERA	2	7/16 X 24	9/16 X 18		
390534	MC390534	N/D	25.4 mm 1"	TERCERA	2	7/16 x 24	7/16 x 24		
390536	MC390536	N/D	33.3 mm 1-5/16"	TERCERA	3	9/16" X 18	7/16" X 24	3/8 X 24	
390541	MC390541	N/D	34.0 mm	TERCERA	2	1/2" X 20	1/2" X 20		
390542	MC390542	N/D	37.0 mm	TERCERA	2	1/2" X 20	1/2" X 20		
390546	MC390546		23.8 mm 15/16"		3	(1)M10 X 1	(2)M10 X 1		
390550	MC390550	N/D	23.8 mm 15/16"	TERCERA	2	M10 X 1	M10 X 1		
390551	MC380551		26.9 mm 1-1/16"		2	(1)M10 X 1	(1)M10 X 1		
390552	MC390552	N/D	25.4 mm 1"	TERCERA	2	M14 X 1.5	M14 X 1.5		
390553	MC390553	N/D	25.4 mm 1"	TERCERA	2	M12x1.0	M12x1.0		
390555	MC390555	N/D	25.4 mm 1"	TERCERA	2	M12 X 1	M12 X 1		
390556	MC390556		26.9 mm 1-1/16"		2	(1)M10 X 1	(1)M10 X 1		
390564	MC390564	N/D	25.4 mm 1"	TERCERA	2	M12 X 1	M12 X 1		
390565	MC390565	N/D	50.8 mm 2"	TERCERA	2	1/2" X 20	9/16 X 18		
390569	MC390569	N/D	25.4 mm 1"	TERCERA	2	M10 X 1	7/16" X 24		
390570	MC390570	N/D	26.9 mm 1-1/16"	TERCERA	3	M10 X 1	M10 X 1	3/8 X 24	
390571	MC390571	N/D	25.4 mm 1"	TERCERA	2	1/2" X 20	1/2" X 20		
390573	MC390573	N/D	26.9 mm 1-1/16"	TERCERA	2	M12 X 1	M12 X 1		
390577	MC390577	N/D	23.8 mm 15/16"	TERCERA	2	7/16 X 24	3/8 X 24		
390579	MC390579	N/D	22.2 mm 7/8"	TERCERA	2	M18 X 1	M18 X 1		
390580	MC390580	N/D	33.3 mm 1-5/16"	TERCERA	3	7/16" X 24	9/16" X 18	3/8" X 24	
390581	MC390581	N/D	25.4 mm 1"	TERCERA	2	M12 X 1	M12 X 1		
390582	MC390582	N/D	25.4 mm 1"	TERCERA	2	M10 X 1	M10 X 1	M10 X 1	
390584	MC390584	N/D	25.4 mm 1"	TERCERA	2	M10 X 1	M10 X 1		
390590	MC390590	N/D	50.8 mm 2"	TERCERA	2	1/2" X 20	9/16 X 18		
390592	MC390592	N/D	34.0 mm	TERCERA	2	M12 X 1.5	M12 X 1.5		
390593	MC390593	N/D	25.4 mm 1"	CUARTA	2	M10 X 1	M10 X 1		
390594	MC390594	N/D	25.4 mm 1"	CUARTA	2	M12 X 1	M10 X 1		
390608	MC390608	N/D	25.4 mm 1"	TERCERA	2	M12 X 1	M12 X 1		
390613	MC390613	N/D	25.4 mm 1"	TERCERA	2	M11 X 1.5	M11 X 1.5		
390615	MC390615	N/D	25.4 mm 1"	TERCERA	2	M10 X 1	M10 X 1		
390618	MC390618	N/D	1" y 3/4"	TERCERA	2	M12 X 1	M12 X 1		
390624	MC390624	N/D	15/16" y 3/4"	TERCERA	2	M12 X 1	M12 X 1		
390632	MC390632	N/D	25.4 mm 1"	CUARTA	2	M12 X 1	M10 X 1		
390633	MC390633	N/D	1" y 13/16"	CUARTA	2	M12 X 1	M12 X 1		
390636	MC390636	N/D	23.8 mm 15/16"	TERCERA	2	M12 X 1	M10 X 1		
390637	MC390637	N/D	25.4 mm 1"	TERCERA	2	M10 X 1	M12 X 1		
390638	MC390638	N/D	23.8 mm 15/16"	TERCERA	3	7/16 X 24	M18 X 1	7/16 X 24	
390639	MC390639	90234	23.8 mm 15/16"	TERCERA	2	M10 X 1	M10 X 1		
390643	MC390643	N/D	23.8 mm 15/16"	TERCERA	4	M12 X 1	M12 X 1	M12 X 1	M12 X 1
390645	MC390645	N/D	25.4 mm 1"	TERCERA	4	M10 X 1	M10 X 1	M10 X 1	M10 X 1



Medidas y especificaciones

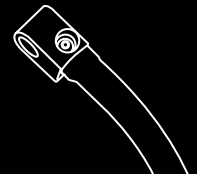
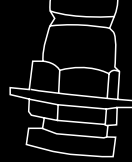

CILINDROS MAESTROS									
No PARTE LUSAC	No PARTE RAYBESTOS	No REPTO LUSAC	MEDIDA	GEN	NO. DE CONEX	DIÁM. DE CONEX. 1	DIÁM. DE CONEX. 2	DIÁM. DE CONEX. 3	DIÁM. DE CONEX. 4
390646	MC390646	114191	22.2 mm 7/8"	TERCERA	2	M11 X 1.5	M12 X 1		
390654	MC390654	N/D	25.4 mm 1"	TERCERA	2	M10 X 1	M10 X 1		
390655	MC390655	N/D	25.4 mm 1"	TERCERA	2	M10 X 1	M10 X 1		
390657	MC390657	N/D	26.9 mm 1-1/16"	TERCERA	2	M12 X 1	M12 X 1		
390660	MC390660	N/D	26.9 mm 1-1/16"	TERCERA	2	M10 X 1	M10 X 1		
390661	MC390661	N/D	26.9 mm 1-1/16"	TERCERA	2	M10 X 1	M10 X 1		
390663	MC390663	N/D	23.8 mm 15/16"	TERCERA	4	M12 X 1	M12 X 1	M12 X 1	M12 X 1
390676	MC390676	N/D	23.8 mm 15/16"	TERCERA	2	M10 X 1	M10 X 1		
390678	MC390678	903310	23.8 mm 15/16"	TERCERA	4	M10 X 1	M11 X 1.5	M10 X 1	M11 X 1.5
390690	MC390690	N/D	25.4 mm 1"	TERCERA	2	M11 X 1.5	M11 X 1.5		
390691	MC390691	N/D	25.4 mm 1"	TERCERA	2	M11 X 1.5	M11 X 1.5		
390693	MC390693	N/D	25.4 mm 1"	TERCERA	2	M12 X 1	M10 X 1	Purgador	
390695	MC390695	N/D	26.9 mm 1-1/16"	TERCERA	2	M18 X 1.5	9/16 X 18		
390696	MC390696	N/D	26.9 mm 1-1/16"	TERCERA	2	M12 X 1	M10 X 1		
390697	MC390697	N/D	25.4 mm 1"	TERCERA	2	1/2" X 20	1/2" X 20		
390698	MC390698	N/D	20.6 mm 13/16"	TERCERA	2	M12 X 1	M12 X 1		
390702	MC390702	N/D	25.4 mm 1"	TERCERA	2	M10 X 1	M12 X 1		
390703	MC390703	N/D	23.8 mm 15/16"	TERCERA	2	M12 X 1	M12 X 1		
390707	MC390707		23.8 mm 15/16"		2	(1)M10 X 1	(1)M10 X 1		
390708	MC390708	N/D	23.8 mm 15/16"	TERCERA	2	7/16 X 24	7/16 X 24		
390709	MC390709	N/D	26.9 mm 1-1/16"	TERCERA	2	7/16 x 24	7/16x24		
390710	MC390710	N/D	26.9 mm 1-1/16"	TERCERA	2	M12 X 1	M12 X 1		
390711	MC390711	90711	26.9 mm 1-1/16"	TERCERA	2	M10 X 1	M10 X 1		
390712	MC390712	N/D	26.9 mm 1-1/16"	TERCERA	2	M10 X 1	M10 X 1		
390714	MC390714	N/D	25.4 mm 1"	TERCERA	2	1/2"X 20	1/2"X 20		
390719	MC390719	N/D	23.8 mm 15/16"	TERCERA	2	M12 X 1	M12 X 1		
390720	MC390720		25.4 mm 1"		2	(1) 7/16-24	(1) 7/16-24		
390721	MC390721	N/D	23.8 mm 15/16"	TERCERA	2	M10 X 1	M10 X 1		
390722	MC390722	N/D	22.2 mm 7/8"	TERCERA	2	M10 X 1	M10 X 1		
390724	MC390724	N/D	22.2 mm 7/8"	TERCERA	2	M10 X 1	M10 X 1		
390730	MC390730	N/D	23.8 mm 15/16"	TERCERA	2	M10 X 1	M10 X 1		
390732	MC390732	N/D	33.3 mm 1-5/16"	TERCERA	2	(1)M10x1	(1)M12x1		
390734	MC390734	N/D	20.6 mm 13/16"	TERCERA	2	M10 X 1	M10 X 1		
390735	MC390735		20.6 mm 13/16"		2	(1)M10 X 1	(1)M10 X 1		
390739	MC390739	N/D	25.4 mm 1"	TERCERA	2	M10 X 1	M12 X 1		
390740	MC390740	N/D	31.7 mm 1-1/4"	TERCERA	2	(1)7/16-24	(1)9/16-18		
390741	MC390741	N/D	28.5 mm 1-1/8"	TERCERA	2	18 X 1.5	9/16 X 10		
390742	MC390742	N/D	33.3 mm 1-5/16"	TERCERA	2	M12 X 1	M10 X 1		
390745	MC390745	N/D	25.4 mm 1"	TERCERA	2	M12 X 1	M10 X 1		
390746	MC390746	90746	20.6 mm 13/16"	TERCERA	2	(1)M10x1	(1)M10x1		
390747	MC390747	N/D	23.8 mm 15/16"	TERCERA	2	M10 X 1	M10 X 1		
390748	MC390748	N/D	26.9 mm 1-1/16"	TERCERA	2	M10 X 1	M10 X 1		
390749	MC390749	N/D	26.9 mm 1-1/16"	TERCERA	4	M10 X 1	M10 X 1	M10 X 1	M10 X 1
390753	MC390753	N/D	22.2 mm 7/8"	TERCERA	2	M10 X 1	M10 X 1		
390754	MC390754	N/D	22.2 mm 7/8"	TERCERA	2	M10 X 1	M10 X 1		
390758	MC390758	N/D	25.4 mm 1"	TERCERA	2	9/16 X 18	1/2"X 20		
390759	MC390759	N/D	22.2 mm 7/8"	TERCERA	2	M10 X 1	M10 X 1		
390760	MC390760	N/D	22.2 mm 7/8"	TERCERA	2	M10 X 1	M10 X 1		
390762	MC390762		28.5 mm 1-1/8"		2	(1)M14 X 1.5	(1)M12 X 1		
390764	MC390764	N/D	23.8 mm 15/16"	TERCERA	2	M12 X 1	M12 X 1		
390765	MC390765	N/D	15/16" y 13/16"	TERCERA	2	M12 X 1	M12 X 1		
390766	MC390766	N/D	1" y 13/16"	TERCERA	2	M12 X 1	M12 X 1		
390768	MC390768	N/D	1" y 7/8"	TERCERA	2	M12 X 1	M12 X 1		
390772	MC390772	N/D	1" y 7/8"	TERCERA	2	M12 X 1	M12 X 1		
390774	MC390774		25.4 mm 1"		2	(1)M10 X 1	(1)M10 X 1		
390777	MC390777	N/D	25.4 mm 1"	TERCERA	2	M10 X 1	M10 X 1		

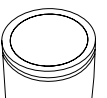

Medidas y especificaciones



CILINDROS MAESTROS

No PARTE LUSAC	No PARTE RAYBESTOS	No REPTO LUSAC	MEDIDA	GEN	NO. DE CONEX	DIÁM. DE CONEX. 1	DIÁM. DE CONEX. 2	DIÁM. DE CONEX. 3	DIÁM. DE CONEX. 4
390778	MC390778	N/D	25.4 mm 1"	TERCERA	2	M12 X 1	M12 X 1		
390780	MC390780	N/D	25.4 mm 1"	TERCERA	2	M10 X 1	M10 X 1		
390781	MC390781	N/D	25.4 mm 1"	TERCERA	2	M10 X 1	M10 X 1		
390782	MC390782	N/D	33.3 mm 1-5/16"	TERCERA	2	M10 X 1	M12 X 1		
390783	MC390783		20.6 mm 13/16"		2	(1)M10 X 1	(1)M10 X 1		
390784	MC390784		20.6 mm 13/16"		2	(1)M14 X 1.5	(1)M14 X 1.5		
390787	MC390787	N/D	28.5 mm 1-1/8"	TERCERA	2	18 X 1.5	9/16 X 18		
390788	MC390788	N/D	25.4 mm 1"	TERCERA	2	7/16 X 24	7/16 X 24		
390790	MC390790	N/D	26.9 mm 1-1/16"	TERCERA	2	M12 X 1	M10 X 1		
390800	MC390800	N/D	23.8 mm 15/16"	TERCERA	2	M10 X 1	M10 X 1		
390802	MC390802	N/D	31.7 mm 1-1/4"	TERCERA	2	7/16 X 24	9/16 X 18		
390804	MC390804	N/D	34.0 mm	TERCERA	2	1/2"X 20	1/2"X 20		
390805	MC390805	N/D	31.7 mm 1-1/4"	TERCERA	2	1/2"X 20	1/2"X 20		
390806	MC390806	N/D	31.7 mm 1-1/4"	TERCERA	2	1/2"X 20	1/2"X 20		
390807	MC390807	N/D	22.2 mm 7/8"	TERCERA	2	M10 X 1	M10 X 1		
390808	MC390808	N/D	22.2 mm 7/8"	TERCERA	2	M10 X 1	M10 X 1		
390809	MC390809	N/D	23.8 mm 15/16"	TERCERA	4	M12 X 1	M12 X 1	M12 X 1	M12 X 1
390810	MC390810	N/D	26.9 mm 1-1/16"	TERCERA	2	M12 X 1	M12 X 1		
390811	MC390811	N/D	28.5 mm 1-1/8"	TERCERA	2	M12 X 1	M10 X 1		
390812	MC390812	N/D	25.4 mm 1"	TERCERA	2	M10 X 1	M12 X 1		
390816	MC390816	N/D	23.8 mm 15/16"	TERCERA	2	7/16 X 24	7/16 X 24		
390818	MC390818		37.0 mm		2	(1) 1/2-20	(1) 1/2-20		
390819	MC390819		23.8 mm 15/16"		2	(1)M12 X 1	(1)M12 X 1		
390820	MC390820	N/D	30.1 mm 1-3/16"	TERCERA	2	7/16 X 24	9/16x18		
390821	MC390821	N/D	33.3 mm 1-5/16"	TERCERA	2	M10 X 1	M12 X 1		
390824	MC390824		20.6 mm 13/16"		2	(1)M10 X 1	(1)M10 X 1		
390825	MC390825	N/D	22.2 mm 7/8"	TERCERA	2	M10 X 1	M10 X 1		
390832	MC390832	N/D	22.2 mm 7/8"	TERCERA	2	M10 X 1	M10 X 1		
390833	MC390833	N/D	20.6 mm 13/16"	TERCERA	2	M10 X 1	M10 X 1		
390835	MC390835		25.4 mm 1"		3	(2)M12 X 1	(1)M12 X 1		
390838	MC390838	N/D	25.4 mm 1"	TERCERA	2	M10 X 1	M10 X 1		
390843	MC390843	N/D	34.0 mm	TERCERA	2	1/2"X 20	1/2"X 20		
390845	MC390845	N/D	25.4 mm 1"	TERCERA	2	M10 X 1	M10 X 1		
390847	MC390847	N/D	31.7 mm 1-1/4"	TERCERA	2	9/16 X 18	7/16 X 24		
390848	MC390848	N/D	33.3 mm 1-5/16"	TERCERA	3	9/16 X 18	7/16 X24	3/8 X 24	
390849	MC390849	N/D	31.7 mm 1-1/4"	TERCERA	2	9/16 X 18	7/16 X 24		
390852	MC390852	N/D	31.7 mm 1-1/4"	TERCERA	2	M12 X 1	M13X1.5		
390853	MC390853	N/D	31.7 mm 1-1/4"	TERCERA	2	M12 X 1	M13 X 1.5		
390854	MC390854	N/D	25.4 mm 1"	TERCERA	2	M10 X 1	M10 X 1		
390855	MC390855		25.4 mm 1"		2	(1)M12 X 1	(1)M12 X 1		
390857	MC390857	N/D	22.2 mm 7/8"	TERCERA	2	M10 X 1	M10 X 1		
390858	MC390858	N/D	23.8 mm 15/16"	TERCERA	2	M10 X 1	M10 X 1		
390859	MC390859	N/D	23.8 mm 15/16"	TERCERA	2	M12 X 1	M12 X 1		
390860	MC390860	N/D	20.6 mm 13/16"	TERCERA	2	M10 X 1	M10 X 1		
390867	MC390867	N/D	25.4 mm 1"	TERCERA	2	M10 X 1	M10 X 1		
390868	MC390868	N/D	25.4 mm 1"	TERCERA	2	M10 X 1	M10 X 1		
390870	MC390870	N/D	19.0 mm 3/4"	TERCERA	2	M10 X 1	M10 X 1		
390874	MC390874	N/D	25.4 mm 1"	TERCERA	2	M10 X 1	M10 X 1		
390881	MC390881	N/D	22.2 mm 7/8"	TERCERA	2	M10 X 1	M10 X 1		
390885	MC390885		23.8 mm 15/16"		2	(1)M10 X 1	(1)M10 X 1		
390886	MC390886	N/D	25.4 mm 1"	TERCERA	2	M10 X 1	M10 X 1		
390888	MC390888	N/D	22.2 mm 7/8"	TERCERA	2	M10 X 1	M10 X 1		
390897	MC390897	N/D	25.4 mm 1"	TERCERA	4	M10 X 1	M16 X 1	M10 X 1	M16 X 1
390898	MC390898	N/D	22.2 mm 7/8"	TERCERA	2	M10 X 1	M10 X 1		
390899	MC390899	N/D	23.8 mm 15/16"	TERCERA	2	M10 X 1	M10 X 1		
390908	MC390908	N/D	25.4 mm 1"	TERCERA	2	1/2 X 20	1/2 X 20		
390909	MC390909	N/D	26.9 mm 1-1/16"	TERCERA	2	M12 X 1	M12 X 1		

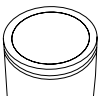



Medidas y especificaciones

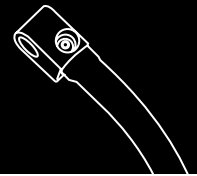
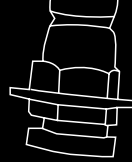

CILINDROS MAESTROS									
No PARTE LUSAC	No PARTE RAYBESTOS	No REPTO LUSAC	MEDIDA	GEN	NO. DE CONEX	DIÁM. DE CONEX. 1	DIÁM. DE CONEX. 2	DIÁM. DE CONEX. 3	DIÁM. DE CONEX. 4
390910	MC390910		25.4 mm 1"		2	(1)M12 X 1	(1)M12 X 1		
390918	MC390918	N/D	26.9 mm 1-1/16"	TERCERA	2	M12 X 1	M12 X 1		
390919	MC390919	N/D	25.4 mm 1"	TERCERA	2	M14 X 1.5	M14 X 1.5		
390922	MC390922	N/D	25.4 mm 1"	TERCERA	2	M12 X 1	M12 X 1		
390923	MC390923	N/D	7/8" y 13/16"	TERCERA	2	M10 X 1	M12 X 1		
390924	MC390924	N/D	25.4 mm 1"	TERCERA	2	M12 X 1	M12 X 1		
390925	MC390925	N/D	23.8 mm 15/16"	TERCERA	3	M12 X 1	M12 X 1	M12 X 1	
390926	MC390926	N/D	28.5 mm 1-1/8"	TERCERA	2	M10 X 1	M12 X 1		
390927	MC390927	N/D	28.5 mm 1-1/8"	TERCERA	2	M10 X 1	M12 X 1		
390930	MC390930	N/D	28.5 mm 1-1/8"	TERCERA	2	1/2"X 20	1/2"X 20		
390931	N/D	N/D	22.2 mm 7/8"	TERCERA	4	M10 X 1	M10 X 1	M10 X 1	M10 X 1
390933	MC390933	N/D	23.8 mm 15/16"	TERCERA	2	M12 X 1	M12 X 1		
390947	MC390947	N/D	25.4 mm 1"	TERCERA	2	M10 X 1	M10 X 1		
390956	MC390956	N/D	38.1 mm 1-1/2"	TERCERA	2	M10 X 1	M12 X 1		
390957	MC390957	N/D	33.3 mm 1-5/16"	TERCERA	2	M10 X 1	M12 X 1		
390960	MC390960	N/D	25.4 mm 1"	TERCERA	2	M12 X 1	M12 X 1		
390961	MC390961	N/D	31.7 mm 1-1/4"	TERCERA	2	7/16 X 24	9/16 X 18		
390964	MC390964	N/D	20.6 mm 13/16"	TERCERA	2	M10 X 1	M10 X 1		
390965	MC390965	N/D	20.6 mm 13/16"	TERCERA	2	M10 X 1	M10 X 1		
390966	MC390966	N/D	22.2 mm 7/8"	TERCERA	2	M10 X 1	M10 X 1		
390968	MC390968	N/D	22.2 mm 7/8"	TERCERA	2	M12 X 1	M12 X 1		
390970	MC390970		22.2 mm 7/8"		2	(1)M12 X 1	(1)M12 X 1		
390971	MC390971		22.2 mm 7/8"		2	M10 X 1.0	M10 X 1.0		
390975	MC390975	N/D	23.8 mm 15/16"	TERCERA	2	M12 X 1	M12 X 1		
390976	MC390976	N/D	31.7 mm 1-1/4"	TERCERA	2	M10 X 1	M12 X 1		
390977	MC390977	N/D	25.4 mm 1"	TERCERA	2	M12 X 1	M12 X 1		
390978	MC390978	N/D	25.4 mm 1"	TERCERA	2	M12 X 1	M12 X 1		
390979	MC390979	N/D	26.9 mm 1-1/16"	TERCERA	2	M12 X 1	M12 X 1		
390980	MC390980		25.4 mm 1"		2	(1)M12 X 1	(1)M12 X 1		
390983	MC390983	N/D	26.9 mm 1-1/16"	TERCERA	2	1/2 X 20	1/2 X 20		
390985	MC390985	N/D	22.2 mm 7/8"	TERCERA	2	M10 X 1	M12 X 1		
390986	MC390986	N/D	31.7 mm 1-1/4"	TERCERA	2	M12 X 1	M12 X 1		
390988	MC390988		26.9 mm 1-1/16"		2	(1)M12 X 1	(1)M12 X 1		
390991	MC390991	N/D	25.4 mm 1"	TERCERA	2	M14x1.5	M14x1.5		
390996	MC390996	N/D	25.4 mm 1"	TERCERA	2	M10 X 1	M10 X 1		
390997	MC390997	N/D	22.2 mm 7/8"	TERCERA	2	M12 X 1	M12 X 1		
390998	MC390998	N/D	25.4 mm 1"	TERCERA	2	M12 X 1	M12 X 1		
391000	MC391000	N/D	22.2 mm 7/8"	TERCERA	2	M10 X 1	M10 X 1		
391001	MC391001		1 1/16"		2	(1)M12 X 1	(1)M12 X 1		
391002	MC391002		19.0 mm 3/4"		2	(1)M12 X 1	(1)M12 X 1		
391004	MC391004	N/D	22.2 mm 7/8"	TERCERA	2	M12 X 1	M12 X 1		
391005	MC391005	N/D	20.6 mm 13/16"	TERCERA	2	M10 X 1	M10 X 1		
391006	MC391006	N/D	20.6 mm 13/16"	TERCERA	2	M10 X 1	M10 X 1		
391007	MC391007	N/D	26.9 mm 1-1/16"	TERCERA	2	M14 X 1.5	M14 X 1.5		
391008	MC391008		25.4 mm 1"		2	(1)M10 X 1	(1)M10 X 1		
391010	MC391010		25.4 mm 1"		2	(1)M12 X 1	(1)M12 X 1		
391013	MC391013		22.2 mm 7/8"		2	(1)M10 X 1	(1)M10 X 1		
391014	MC391014		25.4 mm 1"		2	(1)M10 X 1	(1)M10 X 1		
391020	MC391020	N/D	26.9 mm 1-1/16"	TERCERA	2	M12 X 1	M12 X 1		
391022	MC391022		22.2 mm 7/8"		4	(2)M10 X 1	(2)M10 X 1		
391024	MC391024		22.2 mm 7/8"		2	(1)M10 X 1	(1)M10 X 1		
391026	MC391026	N/D	37.0 mm	TERCERA	2	1/2"X 20	1/2"X 20		
391030	MC391030	N/D	23.8 mm 15/16"	TERCERA	4	7/16 X 24	7/16 X 24	7/16 X 24	7/16 X 24
391031	MC391031	N/D	22.2 mm 7/8"	TERCERA	2	M10 X 1	M12 X 1		
391032	MC391032		22.2 mm 7/8"		4	(2)M10 X 1	(2)M12 X 1		
391037	MC391037	N/D	25.4 mm 1"	TERCERA	2	M12 X 1	M12 X 1		
391041	MC391041	N/D	26.9 mm 1-1/16"	TERCERA	2	7/16 X 24	9/16 X 18		

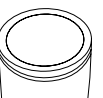

Medidas y especificaciones



CILINDROS MAESTROS									
No PARTE LUSAC	No PARTE RAYBESTOS	No REPTO LUSAC	MEDIDA	GEN	NO. DE CONEX	DIÁM. DE CONEX. 1	DIÁM. DE CONEX. 2	DIÁM. DE CONEX. 3	DIÁM. DE CONEX. 4
391042	MC391042	N/D	38.1 mm 1-1/2"	TERCERA	2	M10 X 1	M12 X 1		
391043	MC391043	N/D	33.3 mm 1-5/16"	TERCERA	2	M10 X 1	M12 X 1		
391045	MC391045	N/D	26.9 mm 1-1/16"	TERCERA	2	M12 X 1	M12 X 1		
391049	MC391049	N/D	25.4 mm 1"	TERCERA	2	M12 X 1	M12 X 1		
391066	MC391066	N/D	20.6 mm 13/16"	TERCERA	2	M12 X 1	M12 X 1		
391068	MC391068		25.4 mm 1"		2	(1) 7/16-24	(1) 3/8-24		
391069	MC391069	N/D	20.6 mm 13/16"	TERCERA	2	M10 X 1	M10 X 1		
391071	MC391071		20.6 mm 13/16"		2	(1)M10 X 1	(1)M12 X 1		
391072	MC391072	N/D	30.1 mm 1-3/16"	TERCERA	2	M12 X 1	M12 X 1		
391080	MC391080		28.5 mm 1-1/8"		2	(1)M12 X 1	(1)M12 X 1		
391081	MC391081	N/D	37.0 mm	TERCERA	2	M12 X 1	M12 X 1		
391082	MC391082	N/D	37.0 mm	TERCERA	2	M12 X 1	M12 X 1		
391085	MC391085	N/D	23.8 mm 15/16"	TERCERA	2	M12 X 1	M12 X 1		
391092	MC391092	N/D	23.8 mm 15/16"	TERCERA	2	M12 X 1	M12 X 1		
391096	MC391096	N/D	25.4 mm 1"	TERCERA	2	M12 X 1	M12 X 1		
391097	MC391097	N/D	25.4 mm 1"	TERCERA	2	M12 X 1	M12 X 1		
391098	MC391098	N/D	25.4 mm 1"	TERCERA	2	M12 X 1	M12 X 1		
391100	MC391100	N/D	22.2 mm 7/8"	TERCERA	2	M12 X 1	M12 X 1		
391101	MC391101	N/D	20.6 mm 13/16"	TERCERA	2	M12 X 1	M12 X 1		
391110	MC391110	N/D	30.1 mm 1-3/16"	TERCERA	2	7/16 X 24	1/2 X 20		
391121	MC391121	N/D	31.7 mm 1-1/4"	TERCERA	2	1/2 X 20	7/16 X 24		
391122	MC391122	N/D	31.7 mm 1-1/4"	TERCERA	2	7/16 X 24	1/2 X 20		
391123	MC391123		25.4 mm 1"		2	(1) 7/16-24	(1) 3/8-24		
391126	MC391126	N/D	26.9 mm 1-1/16"	TERCERA	2	M14 X 1.5	M14 X 1.5		
391129	MC391129	N/D	20.6 mm 13/16"	TERCERA	3	M10 X 1	M10 X 1	M10 X 1	
391130	MC391130		25.4 mm 1"		2	(1)M12 X 1	(1)M12 X 1		
391133	MC391133	N/D	26.9 mm 1-1/16"	TERCERA	2	M12 X 1	M12 X 1		
391134	MC391134	N/D	20.6 mm 13/16"	TERCERA	2	M14 X 1.5	M14 X 1.5		
391137	MC391137		23.8 mm 15/16"		2	(1)M12 X 1	(1)M12 X 1		
391138	MC391138	N/D	22.2 mm 7/8"	TERCERA	2	M12 X 1	M12 X 1		
391139	MC391139		27.0 mm		2	(1)M10 X 1	(1)M12 X 1		
391142	MC391142	N/D	22.2 mm 7/8"	TERCERA	4	7/16 X 24	3/8 X 24	7/16 X 24	3/8 X 24
391143	MC391143	N/D	23.8 mm 15/16"	TERCERA	2	M12 X 1	M12 X 1		
391144	MC391144		22.2 mm 7/8"		2	(1) 7/16-24	(1) 3/8-24		
391145	MC391145		25.4 mm 1"		2	(1)M12 X 1	(1)M12 X 1		
391146	MC391146		22.2 mm 7/8"		4	(1)M10 X 1	(1)M10 X 1		
391150	MC391150		28.5 mm 1-1/8"		2	(1)M14 X 1.5	(1)M10 X 1		
391154	MC391154		25.4 mm 1"		2	(1)M12 X 1.0	(1)M12 X 1.0		
391156	MC391156	N/D	23.8 mm 15/16"	TERCERA	2	M10 X 1	M10 X 1		
391157	MC391157		23.8 mm 15/16"		2	(1)M10 X 1	(1)M10 X 1		
391161	MC391161		1 5/16"		2	(1)M14 X 1.5	(1)M12 X 1.5		
391165	MC391165	N/D	23.8 mm 15/16"	TERCERA	2	M12 X 1	M12 X 1		
391168	MC391168		38.1 mm 1-1/2"		2	(1)M12 X 1	(1)M12 X 1		
391169	MC391169	N/D	28.5 mm 1-1/8"	TERCERA	2	M12 X 1	M12 X 1		
391170	MC391170	N/D	22.2 mm 7/8"	TERCERA	4	M10 X 1	M10 X 1	M10 X 1	M10 X 1
391171	MC391171	N/D	25.4 mm 1"	TERCERA	2	M10 X 1	M10 X 1		
391172	MC391172	N/D	31.7 mm 1-1/4"	TERCERA	2	M14 X 1.5	M14 X 1.5		
391173	MC391173	N/D	22.2 mm 7/8"	TERCERA	2	M10 X 1	M10 X 1		
391175	MC391175	N/D	22.2 mm 7/8"	TERCERA	2	M12 X 1	M12 X 1		
391176	MC391176	N/D	22.2 mm 7/8"	TERCERA	2	M10 X 1	M12 X 1		
391177	MC391177	N/D	22.2 mm 7/8"	TERCERA	2	M12 X 1	M12 X 1		
391178	MC391178	N/D	22.2 mm 7/8"	TERCERA	2	M10 X 1	M12 X 1		
391182	MC391182	N/D	25.4 mm 1"	TERCERA	2	M12 X 1	M12 X 1		
391183	MC391183		38.1 mm 1-1/2"		2	(1)M12 X 1	(1)M12 X 1		
391184	MC391184		38.1 mm 1-1/2"		2	(1)M14 X 1.5	(1)M14 X 1.5		
391185	MC391185	N/D	23.8 mm 15/16"	TERCERA	2	M13 X 1.5	M13 X 1.5		
391186	MC391186	N/D	23.8 mm 15/16"	TERCERA	2	M14 X 1.5	M14 X 1.5		

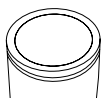



Medidas y especificaciones

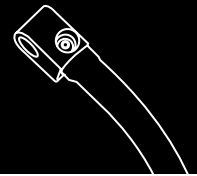
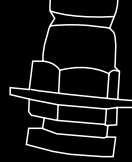

CILINDROS MAESTROS									
No PARTE LUSAC	No PARTE RAYBESTOS	No REPTO LUSAC	MEDIDA	GEN	NO. DE CONEX	DIÁM. DE CONEX. 1	DIÁM. DE CONEX. 2	DIÁM. DE CONEX. 3	DIÁM. DE CONEX. 4
391187	MC391187	N/D	23.8 mm 15/16"	TERCERA	2	M12 X 1	M12 X 1		
391188	MC391188	N/D	33.3 mm 1-5/16"	TERCERA	2	M12 X 1	M10 X 1		
391191	MC391191		33.3 mm 1-5/16"		2	(1)M14 X 1.5	(1)M12 X 1		
391195	MC391195		33.3 mm 1-5/16"		2	(1)M12 X 1	(1)M10 X 1		
391197	MC391197	N/D	38.1 mm 1-1/2"	TERCERA	2	M12 X 1	M10 X 1		
391198	MC391198	N/D	34.9 mm 1-3/8"	TERCERA	2	M12 X 1.5	M10 X 1.5		
391199	MC391199	N/D	26.9 mm 1-1/16"	TERCERA	2	M14 X 1.5	M14 X 1.5		
391200	MC391200	N/D	38.1 mm 1-1/2"	TERCERA	2	M12 X 1	M10 X 1		
391201	MC391201	N/D	26.9 mm 1-1/16"	TERCERA	2	M14 X 1.5	M14 X 1.5		
391202	MC391202		26.9 mm 1-1/16"		2	(1)M14 X 1.5	(1)M14 X 1.5		
391203	MC391203	N/D	26.9 mm 1-1/16"	TERCERA	2	M14 X 1.5	M14 X 1.5		
391204	MC391204		26.9 mm 1-1/16"		2	(1)M14 X 1.5	(1)M14 X 1.5		
391205	MC391205	N/D	12.7 mm 1/2"	TERCERA	2	M10 X 1	M10 X 1		
391218	MC391218	N/D	26.9 mm 1-1/16"	TERCERA	2	M12 X 1	M10 X 1		
391219	MC391219		20.6 mm 13/16"		2	(1)M10 X 1	(1)M10 X 1		
391222	MC391222	N/D	25.4 mm 1"	TERCERA	4	M10 X 1	M10 X 1	M10 X 1	M10 X 1
391225	MC391225	N/D	25.4 mm 1"	TERCERA	2	M12 X 1	M12 X 1		
391227	MC391227		19.0 mm 3/4"		2	(1)M10 X 1	(1)M10 X 1		
391228	MC391228	N/D	19.0 mm 3/4"	TERCERA	2	M10 X 1	M10 X 1		
391231	MC391231		22.2 mm 7/8"		2	(1)M12 X 1	(1)M12 X 1		
391232	MC391232	N/D	22.2 mm 7/8"	TERCERA	2	M12 X 1	M12 X 1		
391233	MC391233	N/D	22.2 mm 7/8"	TERCERA	2	M12 X 1	M12 X 1		
391236	MC391236		33.3 mm 1-5/16"		2	(1)M12 X 1	(1)M10 X 1		
391254	MC391254		23.8 mm 15/16"		2	(1)M12 X 1	(1)M12 X 1		
391267	MC391267		23.8 mm 15/16"		2	(1)M12 X 1	(1)M12 X 1		
391271	MC391271		23.8 mm 15/16"		2	(1) 7/16-24	(1) 7/16-24		
391274	MC391274		22.2 mm 7/8"		2	(1)M12 X 1	(1)M12 X 1		
391299	MC391299		20.6 mm 13/16"		2	(1)M10 X 1	(1)M10 X 1		
391304	MC391304	N/D	22.2 mm 7/8"	TERCERA	2	M10 X 1	M10 X 1		
391306	MC391306		23.8 mm 15/16"		2	(1)M10 X 1	(1)M10 X 1		
391307	MC391307		23.8 mm 15/16"		2	(1)M10 X 1	(1)M10 X 1		
391309	MC391309		23.8 mm 15/16"		2	(1)M10 X 1.0	(1)M10 X 1.0		
391310	MC391310		23.8 mm 15/16"		2	(1)M12 X 1	(1)M12 X 1		
391311	MC391311		23.8 mm 15/16"		2	(1)M12 X 1	(1)M12 X 1		
391321	MC391321	N/D	22.2 mm 7/8"	TERCERA	2	M12 X 1	M12 X 1		
391323	MC391324	N/D	23.8 mm 15/16"	TERCERA	2	M12 X 1	M12 X 1		
391324	MC391324	N/D	23.8 mm 15/16"	TERCERA	2	M12 X 1	M12 X 1		
391328	MC391328	N/D	23.8 mm 15/16"	TERCERA	2	M10 X 1	M12 X 1		
391329	MC391329	N/D	23.8 mm 15/16"	TERCERA	2	M10 X 1	M12 X 1		
391330	MC391330	N/D	19.0 mm 3/4"	TERCERA	2	M10 X 1	M10 X 1		
391331	MC391331	N/D	22.2 mm 7/8"	TERCERA	2	M10 X 1	M10 X 1		
391332	MC391332	N/D	22.2 mm 7/8"	TERCERA	2	M10 X 1	M10 X 1		
391333	MC391333	N/D	22.2 mm 7/8"	TERCERA	4	M10 X 1	M10 X 1	M10 X 1	M10 X 1
391337	MC391337	N/D	19.0 mm 3/4"	TERCERA	2	M10 X 1	M10 X 1		
391358	MC391358	N/D	23.8 mm 15/16"	TERCERA	2	M12 X 1	M12 X 1		
391379	MC391379		23.8 mm 15/16"		2	(1)M12 X 1	(1)M12 X 1		
391385	MC391385	N/D	26.9 mm 1-1/16"	TERCERA	2	7/16 X 24	3/8 X 24		
391390	MC391390	N/D	23.8 mm 15/16"	TERCERA	2	M12X1	M12X1		
475431	N/D	N/D	26.9 mm 1-1/16"	TERCERA	2	M10 X 1	M10 X 1		
475973	N/D	N/D	26.9 mm 1-1/16"	TERCERA	2	M10 X 1	M10 X 1		
2623214	MC39075	N/D	31.7 mm 1-1/4"	TERCERA	2	9/16 X 18	1/2" X 20		
3495064	N/D	908080	22.2 mm 7/8"	TERCERA	2	M10 X 1	M10 X 1		
4721565	MC390710	N/D	26.9 mm 1-1/16"	TERCERA	2	M12 X 1	M12 X 1		
5011256	MC390426	N/D	31.7 mm 1-1/4"	TERCERA	2	M10 X 1	M12 X 1		
5011260	MC390511	N/D	25.4 mm 1"	TERCERA	2	M10 X 1	M12 X 1		
5015160	N/D	N/D	23.8 mm 15/16"	TERCERA	2	M10 X 1	M10 X 1		
5017973	N/D	N/D	23.8 mm 15/16"	TERCERA	2	M10 X 1	M10 X 1		

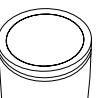

Medidas y especificaciones



CILINDROS MAESTROS

No PARTE LUSAC	No PARTE RAYBESTOS	No REPTO LUSAC	MEDIDA	GEN	NO. DE CONEX	DIÁM. DE CONEX. 1	DIÁM. DE CONEX. 2	DIÁM. DE CONEX. 3	DIÁM. DE CONEX. 4
05019401	N/D	N/D	25.4 mm 1"	TERCERA	2	M10 X 1	M10 X 1		
05069615	N/D	2720	20.6 mm 13/16"	TERCERA	2	M10 X 1	M10 X 1		
5080888	MC390742	N/D	33.3 mm 1-5/16"	TERCERA	2	M12 X 1	M10 X 1		
5083353	N/D	2726	20.6 mm 13/16"	TERCERA	2	M10 X 1	M10 X 1		
9193225	N/D	N/D	23.8 mm 15/16"	TERCERA	2	M10 X 1	M10 X 1		
18009372	MC39570	N/D	24.0 y 31.7 mm	CUARTA	2	9/16 X 18	1/2" X 20		
18026274	MC390427	N/D	25.4 mm 1"	TERCERA	2	1/2" X 20	9/16 X 18		
18029970	MC390278	N/D	40.0 mm	TERCERA	2	9/16 X 18	1/2 X 20		
18060790	MC390542	N/D	37.0 mm	TERCERA	2	1/2" X 20	1/2" X 20		
39009900	N/D	N/D	25.4 mm 1"	TERCERA	2	M10 X 1	M10 X 1		
39009901	N/D	N/D	22.2 mm 7/8"	TERCERA	2	M10 X 1	M10 X 1		
39009902	N/D	N/D	20.6 mm 13/16"	TERCERA	4	M10 X 1	M10 X 1	M12 X 1	M12 X 1
39009903	N/D	N/D	23.8 mm 15/16"	TERCERA	2	M10 X 1	M10 X 1		
39009904	N/D	N/D	23.8 mm 15/16"	TERCERA	4	M10 X 1	M10 X 1	M10 X 1	M10 X 1
39009906	N/D	N/D	23.8 mm 15/16"	TERCERA	4	M10 X 1	M10 X 1	M10 X 1	M10 X 1
39009907	N/D	N/D	22.2 mm 7/8"	TERCERA	2	M10 X 1	M10 X 1		
39009908	N/D	N/D	25.4 mm 1"	TERCERA	2	3/8 " X 24	3/8 " X 24		
39009909	N/D	N/D	20.6 mm 13/16"	TERCERA	2	M10 X 1	M10 X 1		
39009910	N/D	N/D	25.4 mm 1"	TERCERA	2	3/8 " X 24	3/8 " X 24		
39009911	N/D	N/D	20.6 mm 13/16"	TERCERA	4	M10 X 1	M10 X 1	M10 X 1	M10 X 1
39009912	N/D	N/D	19.0 mm 3/4"	TERCERA	2	M10 X 1	M10 X 1		
39009913	N/D	N/D	23.8 mm 15/16"	TERCERA	2	M10 X 1	M10 X 1		
39009914	N/D	N/D	20.6 mm 13/16"	TERCERA	2	M10 X 1	M10 X 1		
39009915	N/D	N/D	25.4 mm 1"	TERCERA	2				
39009916	N/D	N/D	34.9 mm 1-3/8"	TERCERA	2	3/8 " X 24	3/8 " X 24		
93172089	N/D	N/D	25.4 mm 1"	TERCERA	2	M12X1	M12X1		
93305031	N/D	N/D	23.8 mm 15/16"	TERCERA	2	M10 X 1	M10 X 1		
106437-A	MC36352	71500	31.7 mm 1-1/4"	TERCERA	2	9/16" X 18	3/8" X 24		
106437-B	MC36408	83075	31.7 mm 1-1/4"	TERCERA	2	9/16" X 18	3/8" X 24		
390700RL	N/D	N/D	20.6 mm 13/16"	TERCERA	4	M10 X 1	M10 X 1	M10 X 1	M10 X 1
390801RL	N/D	830	20.6 mm 13/16"	TERCERA	4	M10 X 1	M10 X 1	M12 X 1	M12 X 1
390901RL	N/D	90901	20.6 mm 13/16"	TERCERA	4	M10 X 1	M10 X 1	M10 X 1	M10 X 1
390911RL	N/D	N/D	20.6 mm 13/16"	TERCERA	4	M10 X 1	M10 X 1	M10 X 1	M10 X 1
390921RL	N/D	N/D	22.2 mm 7/8"	TERCERA	4	M10 X 1	M10 X 1	M10 X 1	M10 X 1
390941RL	N/D	N/D	20.6 mm 13/16"	TERCERA	4	M10 X 1	M10 X 1	M10 X 1	M10 X 1
390951RL	N/D	N/D	20.6 mm 13/16"	TERCERA	3	M10 X 1	M10 X 1	M10 X 1	
4601000Q	N/D	904080	20.6 mm 13/16"	TERCERA	4	M10 X 1	M10 X 1	M12 X 1	M12 X 1
460107B7	MC390441	N/D	25.4 mm 1"	TERCERA	2	M10 X 1	M10 X 1		
460108B6	MC390466	N/D	25.4 mm 1"	TERCERA	2	M10 X 1	M10 X 1		
46010A05	MC39555	N/D	19.0 y 23.8 mm	TERCERA	2	M10 X 1	M10 X 1		
46010F40	N/D	N/D	23.8 mm 15/16"	TERCERA	3	M10 X 1	M10 X 1	M10 X 1	
46010J01	MC39228	N/D	19.0 mm 3/4"	SEGUNDA	4	M10 X 1	M10 X 1	Purgador	Purgador
46010W87	MC39150	N/D	22.2 mm 7/8"	SEGUNDA	4	M10 X 1	M10 X 1	Purgador	Purgador
681-MC	MC681	3613	31.7 mm 1-1/4"	SENCILLO	3	1/2" X 20	1/2" X 20	1/8" X 27 NPT	
98896-A	MC39712	86626	28.5 mm 1-1/8"	TERCERA	2	9/16" X 20	1/2" X 20		
F7RZ2140	MC390463	N/D	25.4 mm 1"	TERCERA	2	M10 X 1	M12 X 1		
IJ1614019	MC390500	N/D	23.8 mm 15/16"	TERCERA	2	M12 X 1	M12 X 1		
MC390073			23.8 mm 15/16"		2	M12 X 1	M12 X 1		
MC390163			23.8 mm 15/16"		2	M10 X 1			
MC390167			23.8 mm 15/16"		2	(1)M10 X 1.0	(1)M10 X 1.0		
MC390306			25.4 mm 1"		2	M12 X 1	M12 X 1		
MC390439			23.8 mm 15/16"		2	M12 X 1	M12 X 1		
MC390446			25.4 mm 1"		2	M12 X 1	M12 X 1		
MC390468			25.4 mm 1"		2	M10 X 1	M10 X 1		
MC390472			1"		2	M12 X 1.5	M12 X 1		
MC390546			23.8 mm 15/16"		2	(1)M10 X 1	(2)M10 X 1		
MC390551			26.9 mm 1-1/16"		2	M10 X 1	M10 X 1		



Medidas y especificaciones

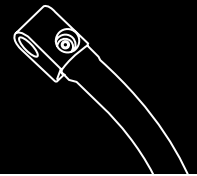
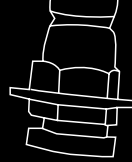

CILINDROS MAESTROS									
No PARTE LUSAC	No PARTE RAYBESTOS	No REPTO LUSAC	MEDIDA	GEN	NO. DE CONEX	DIÁM. DE CONEX. 1	DIÁM. DE CONEX. 2	DIÁM. DE CONEX. 3	DIÁM. DE CONEX. 4
MC390592			34.0 mm		2	(1)M10 X 1	(2)M10 X 1		
MC390621			1 1/16"		2	(1)M10 X 1	(1)M10 X 1		
MC390657			26.9 mm 1-1/16"		2	(1)M12 X 1	(1)M12 X 1		
MC390666			22.2 mm 7/8"		2	(1)M10 X 1	(1)M10 X 1		
MC390707			23.8 mm 15/16"		2	(1)M10 X 1	(1)M10 X 1		
MC390713			25.4 mm 1"		2	(1)M12 X 1	(1)M12 X 1		
MC390714			25.4 mm 1"		2	(1)1/2-20	(1)1/2-20		
MC390758			25.4 mm 1"		2	(1)9/16-18	(1)1/2-20		
MC390763			28.5 mm 1-1/8"		2	(1)M14 X 1.5	(1)M12 X 1.5		
MC390774			25.4 mm 1"		2	(1)M10 X 1	(1)M10 X 1		
MC390784			20.6 mm 13/16"		2	(1)M14 X 1.5	(1)M12 X 1.5		
MC390822			20.6 mm 13/16"		2	(1)M10 X 1	(1)M10 X 1		
MC390823			25.4 mm 1"		2	(1)M12 X 1	(1)M12 X 1		
MC390839			25.4 mm 1"		2	(1)M12 X 1	(1)M12 X 1		
MC390855			25.4 mm 1"		2	(1)M12 X 1	(1)M12 X 1		
MC390860			20.6 mm 13/16"		2	(1)M10 X 1	(1)M10 X 1		
MC390863			7/8"		4	(1)M10 X 1/ M15 X 1	(1)M10 X 1/ M15 X 1		
MC390869			7/8"		4	(1)M10 X 1/ M15 X 1	(1)M10 X 1/ M15 X 1		
MC390873			25.4 mm 1"		2	(1)3/8-24	(1)3/8-24		
MC390879			28.5 mm 1-1/8"		2	(1)M10 X 1	(1)M10 X 1		
MC390885			23.8 mm 15/16"		2	(1)M10 X 1	(1)M10 X 1		
MC390896			26.9 mm 1-1/16"		2	(1)M10 X 1	(1)M10 X 1		
MC390908			25.4 mm 1"		2	(1)M10 X 1	(1)M10 X 1		
MC390915			20.6 mm 13/16"		2	(1)M12 X 1	(1)M12 X 1		
MC390918			26.9 mm 1-1/16"		2	(1)M12 X 1	(1)M12 X 1		
MC390922			25.4 mm 1"		2	(1)M12 X 1	(1)M12 X 1		
MC390956			38.1 mm 1-1/2"		2	(1)M10 X 1	(1)M12 X 1		
MC390958			26.9 mm 1-1/16"		2	(1)M12 X 1	(1)M12 X 1		
MC390967			22.2 mm 7/8"		2	(1)M12 X 1	(1)M12 X 1		
MC390968			22.2 mm 7/8"		2	(1)M12 X 1	(1)M12 X 1		
MC390969			22.2 mm 7/8"		2	(1)M10 X 1	(1)M10 X 1		
MC390970			22.2 mm 7/8"		2	(1)M12 X 1	(1)M12 X 1		
MC390983			26.9 mm 1-1/16"		2	(1)1/2-20	(1)1/2-20		
MC390994			25.4 mm 1"		2	(1)M10 X 1	(1)M10 X 1		
MC390995			25.4 mm 1"		2	(1)M10 X 1	(1)M10 X 1		
MC391012			26.9 mm 1-1/16"		2	(1)7/16 -24	(1)3/8 -24		
MC391014			25.4 mm 1"		2	(1)M10 X 1	(1)M10 X 1		
MC391021			25.4 mm 1"		2	(1)M12 X 1	(1)M12 X 1		
MC391032			22.2 mm 7/8"		2	(1)M10 X 1	(1)M12 X 1		
MC391033			33.3 mm 1-5/16"		2	(1)M10 X 1	(1)M12 X 1		
MC391036			27.0 mm		3	(1)M12 X 1	(1)M12 X 1		
MC391042			38.1 mm 1-1/2"		2	(1)M10 X 1	(1)M12 X 1		
MC391065			23.8 mm 15/16"		3	(1)M12 X 1.0	(1)M12 X 1.0		
MC391068			25.4 mm 1"		2	(1)7/16 -24	(1)3/8 -24		
MC391071			20.6 mm 13/16"		2	(1)M10 X 1	(1)M12 X 1		
MC391079			1"		2	(1)M13 X 1.5	(1)M13 X 1.5		
MC391083			34mm		2	(1)M13 X 1.5	(1)M13 X 1.5		
MC391099			25.4 mm 1"		2	(1)M12 X 1	(1)M12 X 1		
MC391103			15/16"		2	(1)7/16 -24	(1)7/16 -24		
MC391123			25.4 mm 1"		2	(1)7/16 -24	(1)3/8 -24		
MC391124			1 1/16"		2	(1)7/16 -24	(1)3/8 -24		
MC391125			25.4 mm 1"		2	(1)M14 X 1.5	(1)M14 X 1.5		
MC391127			25.4 mm 1"		2	(1)M14 X 1.5	(1)M14 X 1.5		
MC391129			20.6 mm 13/16"		3	(2)M10 X 1	(1)M12 X 1		
MC391137			23.8 mm 15/16"		2	(1)M12 X 1	(1)M12 X 1		

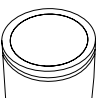

Medidas y especificaciones

CILINDROS MAESTROS

No PARTE LUSAC	No PARTE RAYBESTOS	No REPTO LUSAC	MEDIDA	GEN	NO. DE CONEX	DIÁM. DE CONEX. 1	DIÁM. DE CONEX. 2	DIÁM. DE CONEX. 3	DIÁM. DE CONEX. 4
MC391139			27.0 mm		2	(1)M10 X 1	(1)M12 X 1		
MC391147			26.9 mm 1-1/16"		2	(1)M12 X 1	(1)M12 X 1		
MC391155			23.8 mm 15/16"		2	(1)M10 X 1	(1)M10 X 1		
MC391158			25.4 mm 1"		2	(1)M12 X 1	(1)M12 X 1		
MC391160			20.6 mm 13/16"		2	(1)M12 X 1	(1)M12 X 1		
MC391161			33.3 mm 1-5/16"		2	(1)M14 X 1.5	(1)M12 X 1.5		
MC391162			22.2 mm 7/8"		2	(1)M14 X 1.5	(1)M14 X 1.5		
MC391163			38.1 mm 1-1/2"		2	(1)M14 X 1.5	(1)M12 X 1.5		
MC391164			30.1 mm 1-3/16"		2	(1)M14 X 1.5	(1)M12 X 1.5		
MC391168			38.1 mm 1-1/2"		2	(1)M12 X 1	(1)M12 X 1		
MC391175			22.2 mm 7/8"		2	(1)M12 X 1	(1)M12 X 1		
MC391176			22.2 mm 7/8"		2	(1)M10 X 1	(1)M10 X 1		
MC391177			22.2 mm 7/8"		2	(1)M12 X 1	(1)M12 X 1		
MC391178			22.2 mm 7/8"		2	(1)M10 X 1	(1)M12 X 1		
MC391179			34.0 mm		2	(1)M12 X 1	(1)M12 X 1		
MC391180			37.0 mm		2	(1)M14 X 1.5	(1)M12 X 1.5		
MC391181			26.9 mm 1-1/16"		2	(1)M12 X 1.5	(1)M12 X 1.5		
MC391182			25.4 mm 1"		2	(1)M12 X 1	(1)M12 X 1		
MC391187			23.8 mm 15/16"		2	(1)M12 X 1	(1)M12 X 1		
MC391188			33.3 mm 1-5/16"		2	(1)M12 X 1	(1)M10 X 1		
MC391189			26.9 mm 1-1/16"		2	(1)M12 X 1	(1)M12 X 1		
MC391190			13/16" & 21/32"		5	M12 X 1.5	M12 X 1.5		
MC391192			33.3 mm 1-5/16"		2	(1)M14 X 1.5	(2)M12 X 1		
MC391193			33.3 mm 1-5/16"		2	M12 X 1.5	M10 X 1.5		
MC391194			33.3 mm 1-5/16"		2	(1)M12 X 1.5	(1)M10 X 1.5		
MC391196			38.1 mm 1-1/2"		2	(1)M14 X 1.5	(2)M12 X 1		
MC391199			26.9 mm 1-1/16"		2	(1)M14 X 1.5	(2)M12 X 1		
MC391201			26.9 mm 1-1/16"		2	(1)M14 X 1.5	(1)M12 X 1		
MC391202			26.9 mm 1-1/16"		2	(1)M14 X 1.5	(1)M14 X 1.5		
MC391204			26.9 mm 1-1/16"		2	(1)M14 X 1.5	(1)M14 X 1.5		
MC391205			12.7 mm 1/2"		2	(1)M14 X 1.5	(1)M14 X 1.5		
MC391206			30.1 mm 1-3/16"		2	(1)M12 X 1.5	(1)M12 X 1.5		
MC391207			22.2 mm 7/8"		2	(1)M10 X 1	(1)M10 X 1		
MC391210			26.9 mm 1-1/16"		2	(1)M14 X 1.5	(1)M14 X 1.5		
MC391211			25.4 mm 1"		2	7/16 -24	7/16 -24		
MC391214			22.2 mm 7/8"		2	(1)M14 X 1.5	(1)M14 X 1.5		
MC391215			23.8 mm 15/16"		2	(1)M12 X 1	(1)M12 X 1		
MC391216			23.8 mm 15/16"		2	(1)M12 X 1	(1)M12 X 1		
MC391218			26.9 mm 1-1/16"		2	(1)M12 X 1	(1)M10 X 1		
MC391219			20.6 mm 13/16"		2	(1)M10 X 1	(1)M10 X 1		
MC391220			25.4 mm 1"		2	(1)M12 X 1	(1)M12 X 1.0		
MC391221			25.4 mm 1"		2	(1)M12 X 1	(1)M12 X 1		
MC391223			13/16"		2	(1)M12 X 1	(1)M12 X 1		
MC391224			13/16"		2	(1)M12 X 1	(1)M12 X 1		
MC391227			19.0 mm 3/4"		2	(1)M12 X 1	(1)M12 X 1		
MC391235			25.4 mm 1"		2	(1)M12 X 1.0	(1)M12 X 1.0		
MC391237			22.2 mm 7/8"		2	(1)M12 X 1.0	(1)M12 X 1.0		
MC391238			20.6 mm 13/16"		2	(1)M12 X 1	(1)M12 X 1		
MC391246			26.9 mm 1-1/16"		2	(1)M12 X 1.5	(1)M12 X 1.5		
MC391247			25.4 mm 1"		2	(1)M12 X 1.5	(1)M12 X 1.5		
MC391251			34.0 mm		2	(1)M14 X 1.5	(1)M14 X 1.5		
MC391252			33.3 mm 1-5/16"		2	(1)M14 X 1.5	(1)M14 X 1.5		
MC391253			33.3 mm 1-5/16"		2	(1)M12 X 1	(1)M12 X 1		
MC391254			23.8 mm 15/16"		2	(1)M12 X 1	(1)M12 X 1		
MC391255			26.9 mm 1-1/16"		2	(1)M10 X 1	(1)M10 X 1		
MC391256			27.0 mm		2	(1)M14 X 1.5	(1)M12 X 1.5		
MC391257			33.3 mm 1-5/16"		2	(1)M14 X 1.5	(1)M12 X 1		
MC391258			22.2 mm 7/8"		2	(1)M12 X 1	(1)M12 X 1		



Medidas y especificaciones

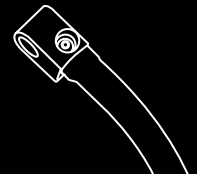
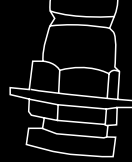

CILINDROS MAESTROS									
No PARTE LUSAC	No PARTE RAYBESTOS	No REPTO LUSAC	MEDIDA	GEN	NO. DE CONEX	DIÁM. DE CONEX. 1	DIÁM. DE CONEX. 2	DIÁM. DE CONEX. 3	DIÁM. DE CONEX. 4
MC391259			1"		2	(1)M12 X 1	(1)M12 X 1		
MC391260			23.8 mm 15/16"		2	(1)M12 X 1	(1)M12 X 1		
MC391261			23.8 mm 15/16"		2	(1)M12 X 1	(1)M12 X 1		
MC391263			22.2 mm 7/8"		2	(1)M10 X 1	(1)M10 X 1		
MC391264			22.2 mm 7/8"		2	(1)M10 X 1	(1)M10 X 1		
MC391265			22.2 mm 7/8"		2	(1)M12 X 1	(1)M12 X 1		
MC391266			22.2 mm 7/8"		2	(1)M12 X 1	(1)M12 X 1		
MC391267			23.8 mm 15/16"		2	(1)M12 X 1	(1)M12 X 1		
MC391268			1"		2	(1)M12 X 1	(1)M12 X 1		
MC391269			1"		2	(1)M12 X 1	(1)M12 X 1		
MC391270			15/16"		2	(1)M12 X 1	(1)M12 X 1		
MC391271			23.8 mm 15/16"		2	(1)M12 X 1	(1)M12 X 1		
MC391294			13/16"		2	(1)M12 X 1	(1)M12 X 1		
MC391295			13/16"		2	M12 X 1	M12 X 1		
MC391296			22.2 mm 7/8"		2	(1)M10 X 1	(1)M10 X 1		
MC391299			20.6 mm 13/16"		2	(1)M10 X 1	(1)M10 X 1		
MC391303			25.4 mm 1"		2	M12 X 1.0	M12 X 1.0		
MC391308			23.8 mm 15/16"		2	M10 X 1.0	M10 X 1.0		
MC391309			23.8 mm 15/16"		2	M12 X 1.0	M12 X 1.0		
MC391310			23.8 mm 15/16"		2	M12 X 1.0	M12 X 1.0		
MC391311			23.8 mm 15/16"		2	M12 X 1.0	M12 X 1.0		
MC391314			22.2 mm 7/8"		2	M12 X 1.0	M12 X 1.0		
MC391315			22.2 mm 7/8"		2	M12 X 1	M12 X 1		
MC391316			22.2 mm 7/8"		2	M12 X 1	M12 X 1		
MC391319			26.9 mm 1-1/16"		2	1-1/6"	1-1/6"		
MC391322			25.4 mm 1"		2	M10 X 1.0	M10 X 1.0		
MC391323			23.8 mm 15/16"		2	(1)M10 X 1.0	(1)M10 X 1.0		
MC391325			26.9 mm 1-1/16"		2	M12 X 1.0	M12 X 1.0		
MC391341			25.4 mm 1"		2	(1)M10 X 1.0	(1)M10 X 1.0		
MC391342			25.4 mm 1"		2	(1)M12 X 1.0	(1)M12 X 1.0		
MC391343			25.4 mm 1"		2	(1)M12 X 1.0	(1)M12 X 1.0		
MC391344			25.4 mm 1"		2	(1)M10 X 1	(1)M10 X 1		
MC391346			22.2 mm 7/8"		2	M12 X 1.0	M12 X 1.0		
MC391347			15/16"		2	(1)M12 X 1.0	(1)M12 X 1.0		
MC391350			25.4 mm 1"		2	(1)M12 X 1.0	(1)M12 X 1.0		
MC391351			25.4 mm 1"		2	M10 X 1.0	M10 X 1.0		
MC391353			22.2 mm 7/8"		2	(1)M12 X 1.0	(1)M12 X 1.0		
MC391359			30.1 mm 1-3/16"		2	(1)M14 X 1.5	(1)M14 X 1.5		
MC391363			19.0 mm 3/4"		2	(1)M12 X 1.0	(1)M12 X 1.0		
MC391364			22.2 mm 7/8"		2	(1)M12 X 1.0	(1)M12 X 1.0		
MC391365			1" & 7/8"		2	M12 X 1.0	M12 X 1.0		
MC391366			23.8 mm 15/16"		2	M12 X 1.0	M12 X 1.0		
MC391376			20.6 mm 13/16"		2	M12 X 1.0	M12 X 1.0		
MC391377			1"		2	M12 X 1.0	M12 X 1.0		
MC391378			22.2 mm 7/8"		2	M12 X 1.0	M12 X 1.0		
MC391384			23.8 mm 15/16"		2	M12 X 1.0	M12 X 1.0		
MC391387			25.4 mm 1"		2	M14 X 1.0	M14 X 1.0		
MC391393			26.9 mm 1-1/16"		2	M12 X 1	M12 X 1		
MC391394			1" & 7/8"		2	M12 X 1	M12 X 1		
MC391400			25.4 mm 1"		2	M12 X 1.0	M12 X 1.0		
MC391401			15/16"		2	(1)M12 X 1.0	(1)M12 X 1.0		
MC391402			N/D		2	(1)M10 X 1.0	(1)M10 X 1.0		
MC391403			N/D						
MC391411			26.9 mm 1-1/16"		2	M12 X 1.0	M12 X 1.0		
MC39800			23.8 mm 15/16"		2	(1)M12 X 1			
MC97071			23.8 mm 15/16"						
MIS55214	N/D	903330	22.2 mm 7/8"	TERCERA	2	M10 X 1	M10 X 1		
XF5Z2140	MC390115	N/D	25.4 mm 1"	TERCERA	2	M10 X 1	M10 X 1		

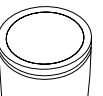

Medidas y especificaciones



CILINDROS MAESTROS, ESCLAVOS Y DE EMBRAGUE DE CLUTCH

No PARTE LUSAC	No PARTE RAYBESTOS	No REPTO LUSAC	MEDIDA	GEN	NO. DE CONEX	DIÁM. DE CONEX. 1	DIÁM. DE CONEX. 2	DIÁM. DE CONEX. 3	DIÁM. DE CONEX. 4
6600	SC-37493	660	19.0 mm 3/4"		2	M10 X 1	M10 X 1		
6900	N/D	690	15.8 mm 5/8"		1	M10 X 1			
6950	N/D	695	15.8 mm 5/8"		1	M10 X 1			
33720	SC-33721	LC26127	25.4 mm 1"		1	7/16" X 24			
37212	SC37212	N/D	19.0 mm 3/4"		1	M10 X 1			
37365	SC37365	N/D	19.0 mm 3/4"		1	M10 X 1			
37487	SC37487	N/D	20.6 mm 13/16"		1	M10 X 1			
37493	SC37493	N/D	19.0 mm 3/4"		1	M10 X 1			
37495	SC37495	N/D	17.4 mm 11/16"		1	M10 X 1			
37498	SC37498	N/D	19.0 mm 3/4"		1	M10 X 1			
37525	SC37525	N/D	20.6 mm 13/16"		1	M10 X 1			
37541	SC37541	N/D	19.0 mm 3/4"		1	M10 X 1			
37627	SC37627	N/D	19.0 mm 3/4"		1	M10 X 1			
37680	SC37680	N/D	17.4 mm 11/16"		1	M10 X 1			
37681	SC37681	N/D	17.4 mm 11/16"		1	M10 X 1			
37682	SC37682	N/D	20.6 mm 13/16"		1	M10 X 1			
37699	SC37699	N/D	20.6 mm 13/16"		1	M10 X 1			
37701	SC37701	N/D	20.6 mm 13/16"		1	M10 X 1			
37725	SC37725	N/D	22.2 mm 7/8"		1	N/D			
37726	SC37726	N/D	25.4 mm 1"		1	SIN ROSCA			
37728	SC37728	N/D	20.5 mm		1	M12 X 1			
37745	SC-37745	7745	31.7 mm 1-1/4"		1	SIN ROSCA			
37748	SC37748	N/D	34.9 mm 1-3/8"		1	N/D			
37790	SC37790	N/D	20.6 mm 13/16"		1	M12 X 1			
37791	SC37791	N/D	20.6 mm 13/16"		1	M12 X 1			
37793	SC37793	N/D	22.2 mm 7/8"		1	7/16 X 24			
37794	SC37794	N/D	23.8 mm 15/16"		1	M12 X 1			
37796	SC37796	N/D	23.8 mm 15/16"		1	M12 X 1			
37815	SC37815	N/D	20.6 mm 13/16"		1	M12 X 1			
37816	SC37816	N/D	20.6 mm 13/16"		1	M12 X 1			
37833	SC37833	N/D	22.2 mm 7/8"		1	M10 X 1			
37834	SC37834	N/D	22.2 mm 7/8"		1	M10 X 1			
37837	SC37837	N/D	19.0 mm 3/4"		1	M10 X 1			
37889	SC37889	N/D	19.0 mm 3/4"		1	M10 X 1			
37897	SC-37897	N/D	N/R		1	SIN ROSCA			
37900	SC37900	N/D	19.0 mm 3/4"		1	M10 X 1			
37901	SC37901	N/D	19.0 mm 3/4"		1	M10 X 1			
37915	SC37915	N/R	N/R		2	SIN ROSCA	SIN ROSCA		
37920	SC37920	N/D	19.0 mm 3/4"		1	M10 X 1			
37928	SC37928	N/D	19.0 mm 3/4"		1	M10 X 1			
37937	SC37937	N/D	22.2 mm 7/8"		1	M12 X 1			
39072	CMA39072	N/D	15.8 mm 5/8"		1	M10 X 1	M10 X 1		
39102	CMA39102	N/D	15.8 mm 5/8"		1	M10 X 1	M10 X 1		
39143	CMA39143	N/D	15.8 mm 5/8"		1	M10 X 1	M10 X 1		
39179	CMA39179 66-2839179	N/D	15.8 mm 5/8"		1	M10 X 1	M10 X 1		
39238	CMA39238	N/D	15.8 mm 5/8"		1	M10 X 1	M10 X 1		
39239	CMA39239	N/D	15.8 mm 5/8"		1	M10 X 1	M10 X 1		
39244	CMA39244	N/D	15.8 mm 5/8"		1	3/8 X 24	3/8 X 24		
39247	CMA39247	N/D	15.8 mm 5/8"		1	M10 X 1	M10 X 1		
39296	CMA39296	N/D	15.8 mm 5/8"		1	M10 X 1	M10 X 1		
39475	CMA39475	N/D	15.8 mm 5/8"		1	M10 X 1	M10 X 1		
39488	CMA39488	N/D	15.8 mm 5/8"		1	M10 X 1.25			
39569	CMA39569	N/D	22.2 mm 7/8"		1	SIN ROSCA	SIN ROSCA		
39582	CMA39582	N/D	15.8 mm 5/8"		1	M10 X 1			
39588	CMA39588	N/D	15.8 mm 5/8"		1	M10 X 1			
39605	CMA39605	N/D	15.8 mm 5/8"		1	M10 X 1	M10 X 1		

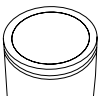



Medidas y especificaciones

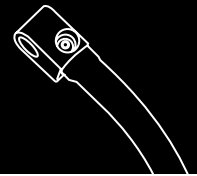
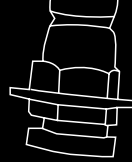

CILINDROS MAESTROS, ESCLAVOS Y DE EMBRAGUE DE CLUTCH									
No PARTE LUSAC	No PARTE RAYBESTOS	No REPTO LUSAC	MEDIDA	GEN	NO. DE CONEX	DIÁM. DE CONEX. 1	DIÁM. DE CONEX. 2	DIÁM. DE CONEX. 3	DIÁM. DE CONEX. 4
39611	CMA39611	N/D	15.8 mm 5/8"		1	M10 X 1	M10 X 1		
39613	CMA39613	N/D	15.8 mm 5/8"		1	M10 X 1	M10 X 1		
39644	CMA39644	N/D	19.0 mm 3/4"		1	7/16 X 24	7/16 X 24		
39645	CMA39645	N/D	17.8 mm 45/64"		1	7/16 X 24	7/16 X 24		
39681	CMA39681	N/D	15.8 mm 5/8"		1	M10 X 1	M10 X 1		
39715	CMA39715 66-2839715	N/D	17.8 mm 45/64"		1	M12 X 1			
39723	CMA39723 66-2839723	N/D	19.0 mm 3/4"		1	7/16 X 24			
39731	CMA39731	N/D	19.0 mm 3/4"		1	M12 X 1			
39732	CMA39732	N/D	17.8 mm 45/64"		1	M12 X 1			
39738	CMA39738 66-2839738	N/D	17.8 mm 45/64"		1	M11 X 1			
39747	CMA39747	N/D	15.8 mm 5/8"		1	M10 X 1	M10 X 1		
39792	CMA39792	N/D	15.8 mm 5/8"		1	M10 X 1	M10 X 1		
39794	CMA39794	N/D	15.8 mm 5/8"		1	M12 X 1	M12 X 1		
39802	CMA39802	N/D	15.8 mm 5/8"		1	M10 X 1			
39803	CMA39803	N/D	15.8 mm 5/8"		1	M10 X 1			
39804	CMA39804	N/D	15.8 mm 5/8"		1	M12 X 1	M12 X 1		
39813	CMA-39813	110274	17.4 mm 11/16"		1	M12 X 1			
39819	CMA39819	N/D	15.8 mm 5/8"		1	M10 X 1			
39820	CMA-39820	N/D	15.8 mm 5/8"		2	M10 X 1	M10 X 1		
39836	CMA39836 66-2839836	N/D	15.8 mm 5/8"		1	M12 X 1	M12 X 1		
39837	CMA-39837	N/D	22.2 mm 7/8"		1	SIN ROSCA			
39840	CMA39840	N/D	19.0 mm 3/4"		1	M12 X 1			
39891	CMA39891	N/D	22.2 mm 7/8"		1	N/D			
39894	CMA-39894	N/D	22.2 mm 7/8"		1	SIN ROSCA			
39895	CMA-39895	N/D	15.8 mm 5/8"		1	SIN ROSCA			
39896	CMA39896	N/D	22.2 mm 7/8"		1	SIN ROSCA			
39903	CMA39903	N/D	15.8 mm 5/8"		1	M10 X 1			
39904	CMA39904	N/D	19.0 mm 3/4"		1	SIN ROSCA			
39906	CMA39906	N/D	15.8 mm 5/8"		1	M10 X 1			
39913	CMA39913 66-2839913	N/D	15.8 mm 5/8"		1	M10 X 1			
39916	CMA39916	N/D	15.8 mm 5/8"		1	M12 X 1			
39929	CMA39929	N/D	17.7 mm		1	M10 X 1			
39930	CMA39930	N/D	15.8 mm 5/8"		1	M10 X 1			
39931	CMA39931 66-2839931	N/D	15.8 mm 5/8"		1	M10 X 1			
39934	CMA39934	N/D	15.8 mm 5/8"		1	M10 X 1			
39936	CMA39936	N/D	15.8 mm 5/8"		1	M10 X 1			
43233	SC-36164	39148	25.4 mm 1"		1	7/16" X 24			
43307	SC-33723	LC26127	25.4 mm 1"		1	7/16" X 24			
54699	CMA-36153	46414	25.4 mm 1"		1	7/16" X 24			
103485	SC-37723	N/D	25.4 mm 1"		1	SIN ROSCA			
110270	CMA-39573	110275	19.0 mm 3/4"		1	SIN ROSCA			
110710	CMA-39560	N/D	22.2 mm 7/8"		1	SIN ROSCA			
103483	SC-37791	103540	20.6 mm 13/16"		1	M12 X 1			
110273	CMA-39732	110274	17.4 mm 11/16"		1	M12 X 1			
300319	N/D	N/D	38.1 mm 1-1/2"		1	M13 X 1.5			
300335	N/D	N/D	23.8 mm 15/16"		1	M14 X 1.0			
350002	CMA350002	N/D	15.8 mm 5/8"		1	M10 X 1			
350003	CMA350003	N/D	15.8 mm 5/8"		1	M10 X 1			
350004	CMA350004	N/D	15.8 mm 5/8"		1	M12 X 1			
350005	CMA350005	N/D	17.8 mm 45/64"		1	SIN ROSCA			
350007	CMA-350007	N/D	17.7 mm		1	SIN ROSCA			
350009	CMA350009	N/D	15.8 mm 5/8"		2	M10 X 1	M10 X 1		

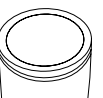

Medidas y especificaciones



CILINDROS MAESTROS, ESCLAVOS Y DE EMBRAGUE DE CLUTCH

No PARTE LUSAC	No PARTE RAYBESTOS	No REPTO LUSAC	MEDIDA	GEN	NO. DE CONEX	DIÁM. DE CONEX. 1	DIÁM. DE CONEX. 2	DIÁM. DE CONEX. 3	DIÁM. DE CONEX. 4
350014	CMA350014	N/D	19.0 mm 3/4"		1	N/D			
350015	CMA350015	N/D	15.8 mm 5/8"		1	SIN ROSCA			
350021	CMA350021	N/D	22.2 mm 7/8"		1	N/D			
350026	CMA-350026	N/D	22.2 mm 7/8"		1	SIN ROSCA			
350028	CMA-350028	N/D	22.2 mm 7/8"		1	SIN ROSCA			
350030	CMA350030	N/D	22.2 mm 7/8"		1	SIN ROSCA			
350032	CMA -350032	50032	18.0 mm		1	SIN ROSCA			
350033	CMA-350033	N/D	22.2 mm 7/8"		1	SIN ROSCA			
350034	CMA350034	N/D	19.09 mm		1	N/D			
350035	CMA350035	N/D	19.0 mm 3/4"		1	N/D			
350037	CMA350037	N/D	19.0 mm 3/4"		1	N/D			
350038	CMA350038	N/D	22.2 mm 7/8"		1	N/D			
350041	CMA350041	N/D	19.0 mm 3/4"		1	SIN ROSCA			
350042	CMA-350042	N/D	17.7 mm		1	SIN ROSCA			
350044	CMA-350044	N/D	22.2 mm 7/8"		1	SIN ROSCA			
350048	CMA350048	N/D	15.8 mm 5/8"		1	N/D			
350052	CMA-350052	N/D	22.2 mm 7/8"		1	SIN ROSCA			
350054	CMA350054	N/D	15.8 mm 5/8"		1	N/D			
350055	CMA350055	N/D	15.8 mm 5/8"		1	N/D			
350057	CMA350057	N/D	22.2 mm 7/8"		1	N/D			
350058	CMA-350058	50058	22.2 mm 7/8"		1	SIN ROSCA			
350061	CMA350061	N/D	22.2 mm 7/8"		1	N/D			
350062	CMA350062	N/D	18.0 mm		1	SIN ROSCA			
350064	CMA350064	N/D	15.8 mm 5/8"		1	M10 X 1			
350067	CMA350067	N/D	19.0 mm 3/4"		1	N/D			
350070	CMA350070	N/D	16.14 mm		1	N/D			
350071	CMA350071	N/D	19.0 mm 3/4"		1	N/D			
350074	CMA350074	N/D	22.2 mm 7/8"		1	N/D			
350077	CMA350077	N/D	22.2 mm 7/8"		1	SIN ROSCA			
350080	CMA350080	N/D	18.25 mm		1	N/D			
350081	CMA350081	N/D	15.8 mm 5/8"		1	M10 X 1			
350082	CMA350082	N/D	15.8 mm 5/8"		1	M10 X 1			
350083	CMA350083	N/D	15.8 mm 5/8"		1	M10 X 1			
350087	CMA350087	N/D	15.8 mm 5/8"		1	M10 X 1			
350088	CMA350088	N/D	18.0 mm		1	N/D			
350089	CMA350089	N/D	18.0 mm		1	N/D			
350090	CMA-350090	N/D	20.6 mm 13/16"		1	SIN ROSCA			
350092	CMA350092	N/D	15.8 mm 5/8"		1	N/D			
350093	CMA350093	N/D	15.8 mm 5/8"		1	M10 X 1			
350104	CMA350104	N/D	18.0 mm		1	N/D			
350105	CMA350105	N/D	18.0 mm		1	N/D			
350108	CMA350108	N/D	19.0 mm 3/4"		1	N/D			
350110	CMA350110	N/D	18.0 mm		1	SIN ROSCA			
350112	CMA350112	N/D	18.0 mm		1	SIN ROSCA			
350113	CMA350113	N/D	18.0 mm		1	SIN ROSCA			
350120	CMA350120	N/D	19.0 mm 3/4"		1	SIN ROSCA			
350123	CMA350123	N/D	15.8 mm 5/8"		1	M12 X 1			
350125	CMA350125	N/D	19.0 mm 3/4"		1	SIN ROSCA			
350134	CMA350134	N/D	18.0 mm		1	N/D			
350135	CMA350135	N/D	18.0 mm		1	N/D			
350147	CMA350147	N/D	19.0 mm 3/4"		1	SIN ROSCA			
350152	CMA350152	N/D	18.0 mm		1	SIN ROSCA			
350155	CMA350155	N/D	19.0 mm 3/4"		1	SIN ROSCA			
350167	CMA350167	N/D	18.0 mm		1	M14 X 1.5			
350182	CMA350182	N/D	18.0 mm		1	N/D			
350204	CMA350204	N/D	15.8 mm 5/8"		1	M10 X 1			
350206	CMA350206	N/D	N/D		2	N/D			

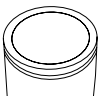



Medidas y especificaciones

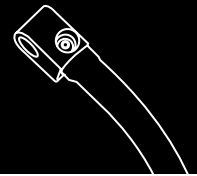
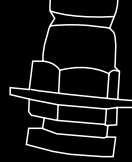

CILINDROS MAESTROS, ESCLAVOS Y DE EMBRAGUE DE CLUTCH									
No PARTE LUSAC	No PARTE RAYBESTOS	No REPTO LUSAC	MEDIDA	GEN	NO. DE CONEX	DIÁM. DE CONEX. 1	DIÁM. DE CONEX. 2	DIÁM. DE CONEX. 3	DIÁM. DE CONEX. 4
360000	SC-360000	N/D	31.7 mm 1-1/4"		1	SIN ROSCA			
360001	SC360001	N/R	N/R		2	SIN ROSCA	SIN ROSCA		
360002	SC-360002	855	31.7 mm 1-1/4"		1	SIN ROSCA			
360003	SC-360003	N/D	25.4 mm 1"		1	SIN ROSCA			
360004	SC-360004	N/D	25.4 mm 1"		1	SIN ROSCA			
360005	SC-360005	N/D	21.0 mm 53/64"		1	SIN ROSCA			
360006	SC360006	N/D	17.4 mm 11/16"		1	M10 X 1			
360014	SC-360014	N/D	21.0 mm 53/64"		1	SIN ROSCA			
360016	SC-360016	N/R	N/R		N/D	N/D			
360022	SC360022	N/D	20.6 mm 13/16"		1	M10 X 1			
360025	SC360025	N/D	19.0 mm 3/4"		1	M10 X 1			
360027	SC-360027	N/D	20.0 mm		1	SIN ROSCA			
360029	SC360029	N/D	21.0 mm 53/64"		1	SIN ROSCA			
360032	SC360032	N/D	19.0 mm 3/4"		1	N/D			
360033	SC360033	N/D	22.2 mm 7/8"		1	M10 X 1			
360045	SC360045	N/D	25.4 mm 1"		1	N/D			
360046	SC-360046	N/D	25.4 mm 1"		1	SIN ROSCA			
360048	SC360048	N/D	25.4 mm 1"		1	N/D			
360049	SC360049	N/D	21.0 mm		2	N/D			
360051	SC-360051	60051	25.4 mm 1"		1	SIN ROSCA			
360052	SC360052	N/D	25.4 mm 1"		1	N/D			
360055	SC360055	N/D	20.6 mm 13/16"		1	M10 X 1			
360058	SC360058	N/D	N/R		1	SIN ROSCA			
360061	SC-360061	N/R	N/R		1	SIN ROSCA			
360062	SC360062	N/D	N/R		1	SIN ROSCA			
360064	SC360064	N/D	20.6 mm 13/16"		1	M10 X 1			
360065	SC360065	N/D	19.0 mm 3/4"		1	M10 X 1			
360066	SC360066	N/D	19.0 mm 3/4"		1	M10 X 1			
360068	SC360068	N/D	20.6 mm 13/16"		1	M10 X 1			
360074	SC360074	N/R	N.R.		2	SIN ROSCA	SIN ROSCA		
360075	SC360075	N/D	21.0 mm 53/64"		N/D	SIN ROSCA			
360081	SC360081	N/D	20.6 mm 13/16"		1	M10 X 1			
360082	SC360082	N/D	22.2 mm 7/8"		1	M10 X 1			
360084	SC360084	N/D	17.4 mm 11/16"		1	SIN ROSCA			
360085	SC360085	N/D	21.0 mm 53/64"		1	SIN ROSCA			
360087	SC360087	N/D	Concentrico		2	SIN ROSCA	SIN ROSCA		
360088	SC360088	N/R	N.R.		2	SIN ROSCA	SIN ROSCA		
360089	SC360089	N/D	Concentrico		2	SIN ROSCA	SIN ROSCA		
360092	SC360092	N/D	22.2 mm 7/8"		1	M12 X 1			
360093	SC360093	N/D	19.0 mm 3/4"		N/D	SIN ROSCA			
360096	SC360096	N/D	N.R.		1	N/D			
360101	SC360101	N/D	N.R.		1	SIN ROSCA			
360107	SC360107	N/D	Concentrico		1	SIN ROSCA			
360108	SC360108	N/D	21.0 mm 53/64"		1	SIN ROSCA			
360109	SC360109	N/D	21.0 mm		1	N/D			
360111	SC360111	N/D	N.R.		N/D	SIN ROSCA			
360121	SC360121	N/D	22.2 mm 7/8"		1	M10 X 1			
360125	SC360125	N/D	19.0 mm 3/4"		1	M10 X 1			
360127	SC360127	N/D	19.0 mm 3/4"		N/D	N/D			
360128	SC360128	N/R	N.R.		N/D	SIN ROSCA			
360138	SC360138	N/D	N.R.		N/D	SIN ROSCA			
360139	SC360139	N/D	17.4 mm 11/16"		1	M10 X 1			
360172	SC360172	N/D	N.R.		N/D	SIN ROSCA			
519868	N/D	N/D	15.8 mm 5/8"		N/D	N/D			
5359822	N/D	N/D	20.6 mm 13/16"		N/D	N/D			
306101E4	CMA39933	N/D	15.8 mm 5/8"		1	M10 X 1			
306108J1	N/D	N/D	15.8 mm 5/8"		N/D	N/D			

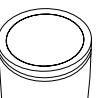

Medidas y especificaciones



CILINDROS MAESTROS, ESCLAVOS Y DE EMBRAGUE DE CLUTCH

No PARTE LUSAC	No PARTE RAYBESTOS	No REPTO LUSAC	MEDIDA	GEN	NO. DE CONEX	DIÁM. DE CONEX. 1	DIÁM. DE CONEX. 2	DIÁM. DE CONEX. 3	DIÁM. DE CONEX. 4
306109Z4	CMA350119	N/D	15.8 mm 5/8"		1	M10 X 1			
30610C07	N/D	N/D	15.8 mm 5/8"		N/D	N/D			
3062003W	SC37627	N/D	19.0 mm 3/4"		1	M10 X 1			
3062031U	SC360057	N/D	19.0 mm 3/4"		1	M10 X 1			
3062056E	SC37680	N/D	17.4 mm 11/16"		1	M10 X 1			
31410330	CMA350109	N/D	15.8 mm 5/8"		1	M10 X 1			
31470302	SC37606	N/D	20.6 mm 13/16"		1	M10 X 1			

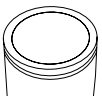

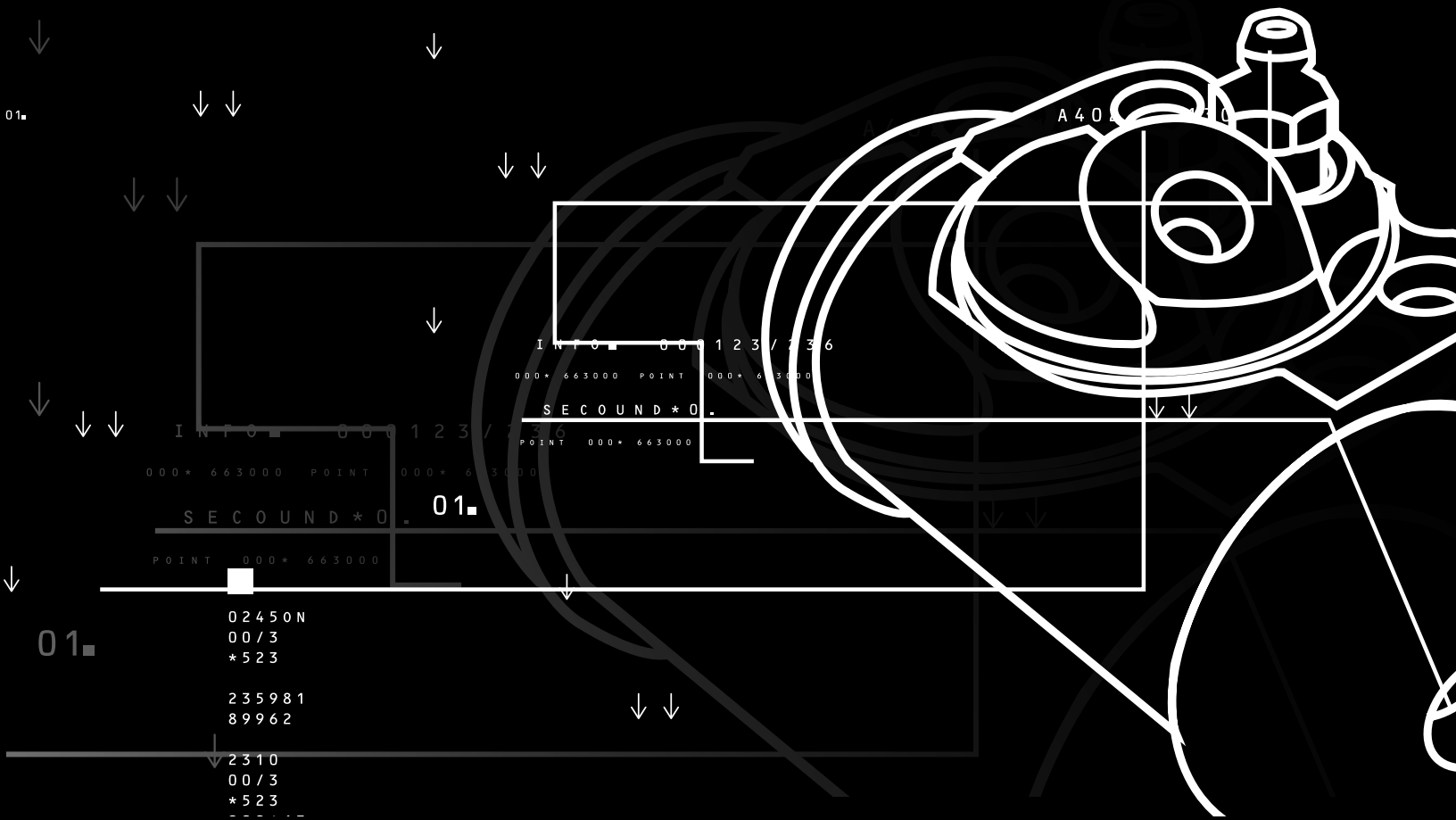

Lusac®



Información técnica

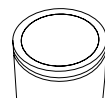



Componentes del Freno de Disco delantero

Sistema de Frenos ABS

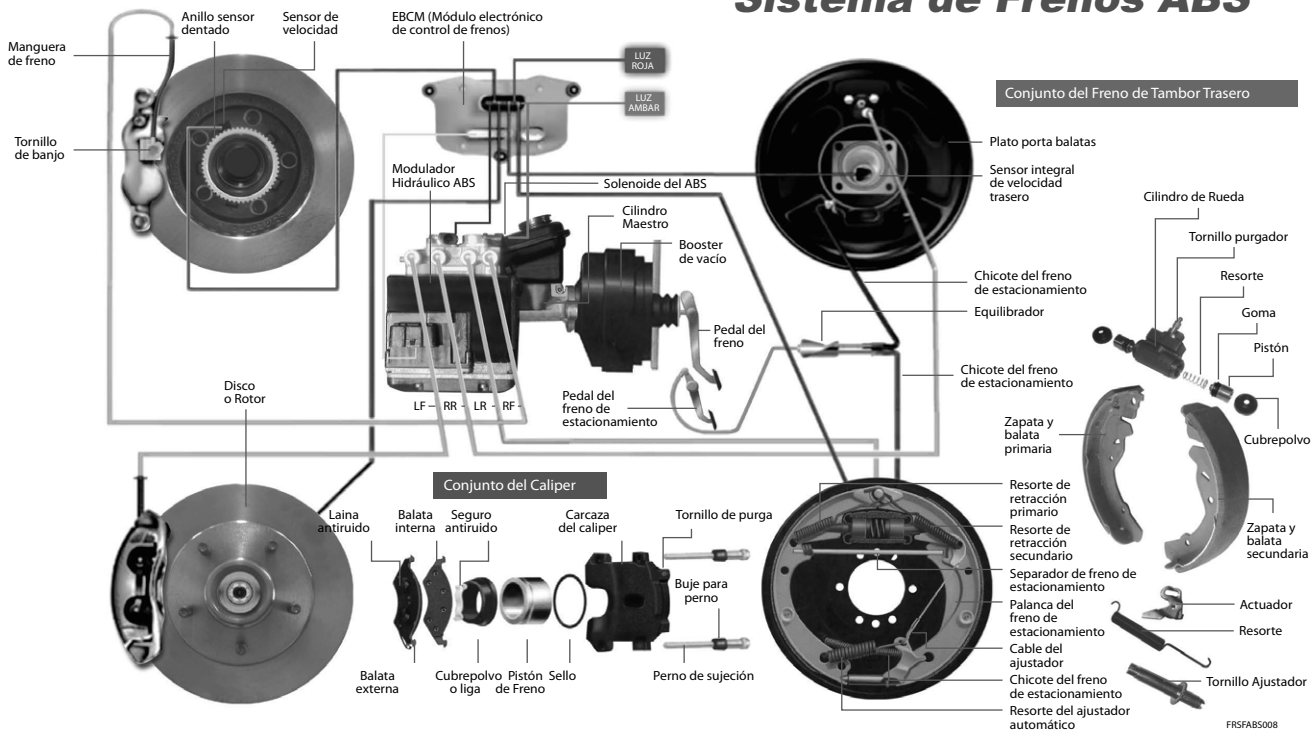

Sistema de Frenos Convencionales

Componentes del Freno de Disco delantero

Conjunto del Freno de Tambor Trasero

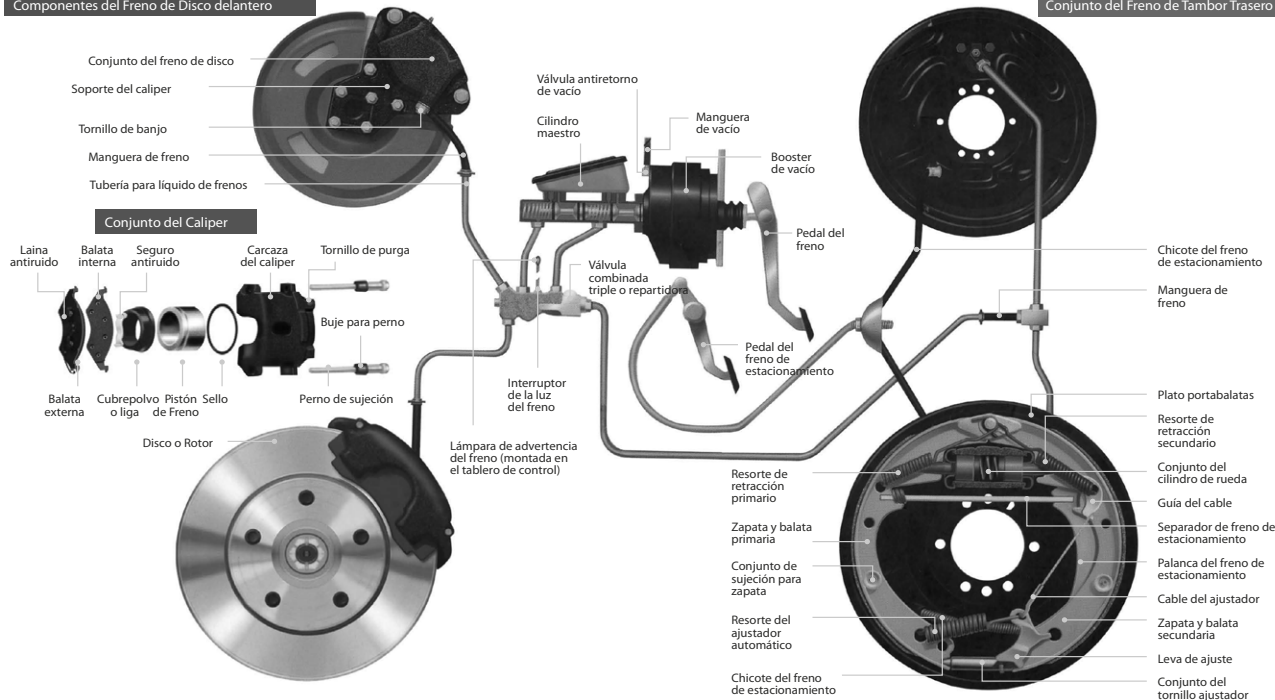

MANUAL DE FRENOS

CONCEPTOS BÁSICOS DE FRENOS

El sistema de frenos está compuesto de tres partes: hidráulica, fricción y mecánica.

Hidráulica

La parte hidráulica está basada en los principios de la Ley de Pascal la cual nos dice que **“los líquidos no se pueden comprimir y al aplicar una fuerza en un sistema hidráulico cerrado a través de un pistón transmitirá la misma fuerza a todos sus puertos de salida”**.

Bajo este principio debemos entender que el sistema de frenos funciona a base de un fluido (no comprimible) y con la ausencia total de aire en sus ductos, este elemento nos puede generar problemas si no realizamos un procedimiento adecuado al reparar un sistema de frenos.

Fricción

Otro concepto de la física nos dice que: **“La energía no puede ser creada ni destruida sólo se puede transformar”**.

Cuando un vehículo está en movimiento tiene energía cinética y si queremos detenerlo debemos transformar ésta en otro tipo de energía que no involucre el movimiento del vehículo, como energía calorífica. Esto se logra mediante la fricción, que es la fuerza que se opone al movimiento entre dos cuerpos en contacto.

Así es que entre más peso y más energía cinética (movimiento) tenga un automóvil más difícil resulta detenerlo, esto se debe compensar con mayor presión y una mayor área de frenado para generar más fricción y disipar el calor.

Para llegar a este objetivo debemos tomar en cuenta las tres características de la fricción:

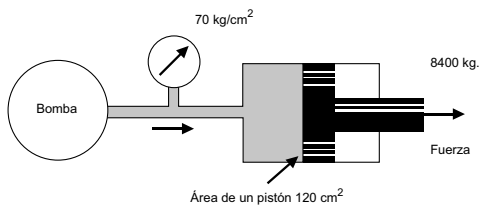

Ley de Pascal de los líquidos a presión

1. Presión

- A) Dos superficies apretadas juntas se resistirán al movimiento basado en la presión aplicada.
- B) La presión afecta directamente las características de la fricción.

2. Área de superficie

- A) Generalmente entre más extensa sea el área de superficie en la balata, más efectivo será el frenado.
- B) El coeficiente de fricción puede afectar la eficiencia del frenado sobre el área de superficie.

3. Coeficiente de fricción

Es el valor proporcionado a la habilidad de los materiales de desplazarse uno sobre otro.

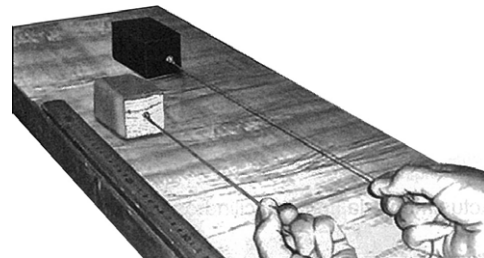

Coeficiente de Fricción de dos materiales diferentes: hule y madera

Mecánica:

La energía mecánica es transmitida por elementos sólidos (metales, pastas, líquidos y otros), la cual puede ser afectada por componentes en mal estado.

En el sistema de frenos, los componentes mecánicos como: pedal del freno, cerrajería (componentes de sujeción de las balatas), así como las mismas balatas y/o los calipers dañados afectarán la transmisión de energía mecánica.

Componentes del sistema hidráulico

Cilindro maestro o bomba de frenos

Es el encargado de transformar la fuerza mecánica en presión hidráulica desde el pedal, transmitiéndose hacia los cilindros de rueda, calipers y válvulas.

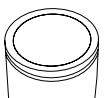



Frenos Hidráulicos

El cilindro maestro está dividido en dos cámaras (o circuitos) de acumulación de presión, las cuales están separadas para proporcionar fuerza de frenado a la mitad de los frenos en caso de fuga en uno de los dos circuitos. Los hay de 1 pistón y de 2 pistones, compuestos y de una sola pieza fabricados en aluminio y hierro nodular.

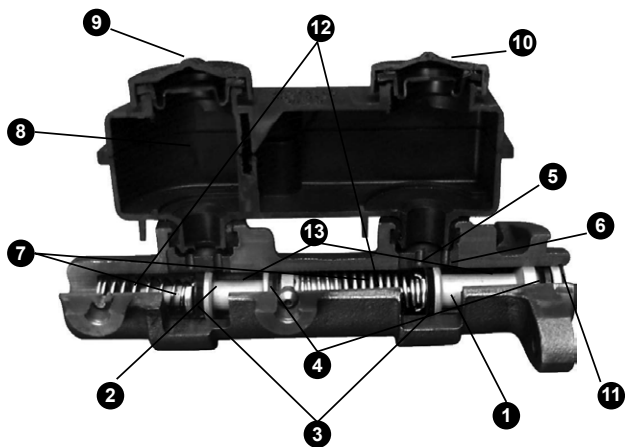

Partes de un cilindro maestro

1. Pistón primario
2. Pistón secundario
3. Sellos primarios
4. Sellos secundarios
5. Puerto de compensación
6. Puerto de llenado
7. Tornillo de campana
8. Depósito de líquido
9. Tapa de depósito
10. Diafragma
11. Seguro de pistón primario
12. Cámara de alta presión
13. Cámara de baja presión

Actualmente la línea de cilindros maestros cuenta con 4 generaciones:

Primera Generación

Se denomina primera generación a aquellos cilindros maestros que contienen dos válvulas de presión residual en ambas salidas y que son utilizados en vehículos equipados con frenos de tambor en las cuatro ruedas.

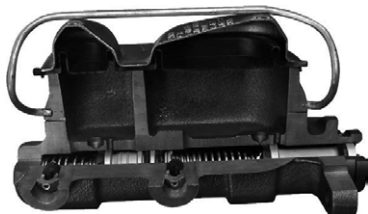

Segunda Generación

Los cilindros maestros de segunda generación están equipados con 1 válvula de presión residual sólo en la salida que va a las ruedas traseras y son utilizados en vehículos equipados con frenos de disco en ruedas delanteras y de tambor en las ruedas traseras.

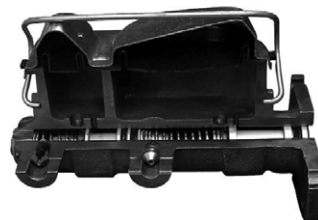

Tercera Generación

Los cilindros maestros de la tercera generación carecen de válvulas de presión residual y son utilizados en los vehículos equipados con frenos de disco en las ruedas delanteras y frenos de tambor en las ruedas traseras, asimismo en vehículos equipados con frenos de disco en las cuatro ruedas.



Cuarta Generación

Cilindros maestros de cuarta generación son aquellos que tienen como característica principal diferente diámetro de los pistones-primario y secundario (doble diámetro), asimismo están equipados con una válvula de accionamiento rápido. La válvula de accionamiento rápido permite el regreso de líquido para frenos al depósito cuando se generan más de 100 PSI en el sistema de frenos.





Válvulas de presión residual (“check”)
 Son las encargadas de tener presión atrapada entre el cilindro maestro y el cilindro de rueda (15 PSI) para mantener las balatas más cerca del tambor, en vehículos equipados con frenos de tambor.

	Válvulas Check	Resortes	Insertos de latón	Válvula de acc. rápido
1a				
2a				
3a				
4a				

Sistemas de frenos

En el parque vehicular nacional existen, o son usados aún, tres diferentes sistemas de frenos que mencionaremos a continuación.

Sistema de frenos sencillo

Este sistema se complementa con un cilindro maestro de un solo pistón, el cual suministra de fluido a todo el sistema hidráulico al presionar el pedal; pero existe un problema con este sistema, que al presentarse una fuga de líquido para frenos en cualquier punto del sistema no habrá poder de frenado.

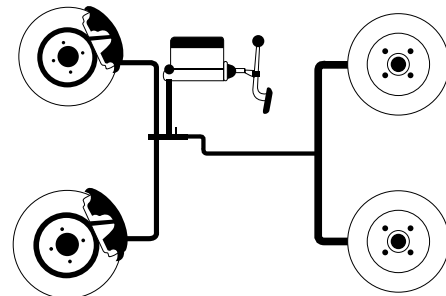

Sistema de frenos dividido (delantero/trasero)

Este sistema es el pionero del uso de los cilindros maestros de doble pistón, el cual nos brinda la ventaja de tener dos sistemas independientes uno adelante y otro atrás, auxiliado por una válvula de combinación o repartidora. Este sistema nos brinda un porcentaje de frenado de 60% adelante y 40% atrás.

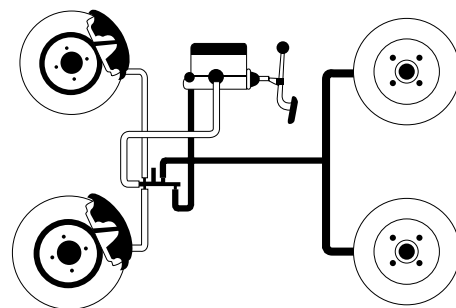

Sistema doble dividido en diagonal

Utilizado en todos los vehículos de tracción delantera, como su nombre lo indica, está dividido diagonalmente (delantera izquierda, trasera derecha, delantera derecha y trasera izquierda). Al igual que el anterior, nos brinda el 50% de frenado cuando exista una pérdida de presión en uno de los dos circuitos. El porcentaje de frenado en este sistema es de 80% adelante y 20% en la parte trasera.

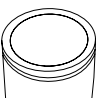
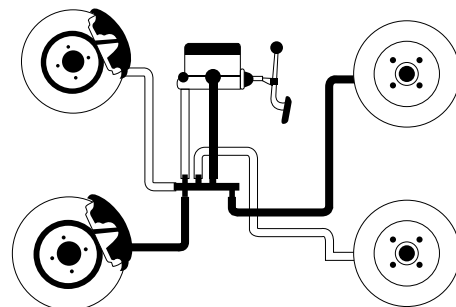



Cilindro de rueda

Los cilindros de rueda convierten la presión hidráulica en fuerza mecánica cuando se aplica presión desde el cilindro maestro por medio de varillas o pistones, este movimiento actúa sobre las zapatas de freno para forzarlas hacia fuera contra el tambor. En cada extremo del cuerpo del cilindro son instalados cubre polvos para mantener la suciedad fuera del cilindro.

Hay un resorte con sellos de alta presión que impide que los sellos se desplomen uno hacia el otro y mantiene la presión que se ejerce sobre los labios de los sellos asegurando un sellado correcto.

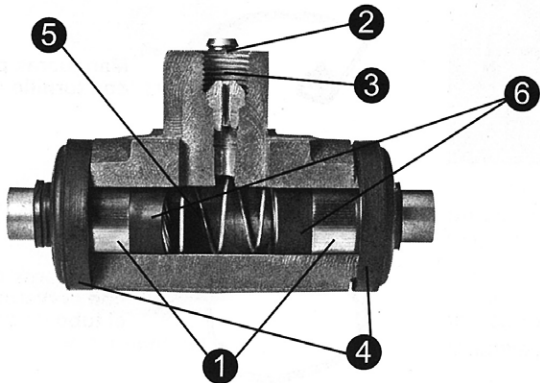

Partes de un cilindro de rueda

1. Pistones
2. Tornillo de purga
3. Entrada de líquido para frenos
4. Cubrepolvos
5. Resorte
6. Sellos

Mangueras para frenos

Son usadas en las ruedas delanteras y/o traseras para dar margen al movimiento de la suspensión y dirección.

Las mangueras para frenos se pueden agrietar, ampollar o presentar fugas en las conexiones por malos manejos, por lo que es necesario que sean revisadas cada 30,000 km o cada 18 meses.

Las mangueras para frenos están fabricadas con 3 capas de hule y 2 capas de lona entramada, su diseño de fabricación hace a la manguera altamente resistente cumpliendo la especificación de la SAE, pudiendo soportar hasta 5000 PSI.

Debe ser resistente a altas temperaturas, flexible y soportar las inclemencias del tiempo.

Otros componentes por el que fluye el líquido para frenos son las tuberías, que están fabricadas con acero de doble pared para resistir la presión que se genera y recubiertas para prevenir el óxido.

Estructura de la manguera para frenos



1. Capa externa de hule
2. Capa intermedia de hule
3. Capa interna de hule
4. Segunda capa de lona entramada
5. Primera capa de lona entramada.



Revisión de la tubería de frenos

NOTA: Nunca sustituya la tubería de frenos por tubería de cobre o cualquier otro material, siempre reemplace igual por igual.



Manguera para frenos con válvulas



Manguera para frenos con tornillo de banjo



Manguera para frenos con curvatura en el tubo de banjo

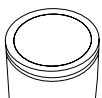



Freno de disco

El freno de disco delantero fue introducido como innovación en 1962 en algunos vehículos Ford, con calipers de 4 pistones bastante problemáticos. Pero fue hasta 1968 cuando se introdujo el caliper del pistón, que es usado actualmente al igual que el de doble pistón (Pick Up). Algunos vehículos de modelos recientes (1994 a 2007) y de alto desempeño usan freno de disco en las cuatro ruedas, delantero y trasero.

Las ventajas del freno de disco son las siguientes:

1. Más resistentes al desvanecimiento, por tener sus componentes expuestos a la intemperie, lo cual le ofrece mayor ventilación.
2. Frenadas más parejas o rectas, la fricción de los frenos de disco es proporcional a la presión aplicada.
3. Pueden frenar estando mojados, el agua simplemente resbala de la superficie vertical del rotor y las balatas frotan constantemente contra la superficie del rotor evitando la acumulación de agua.

Componentes del freno de disco

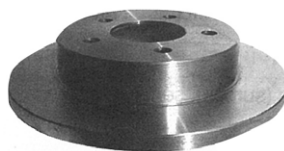
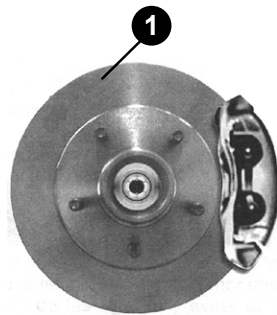

Rotor sólido



Rotor ventilado

1. Rotor o disco
2. Balatas
3. Conjunto de sello y cubrepolvo
4. Pistón
5. Pernos
6. Caliper
7. Herrajería
8. Tornillo purgador

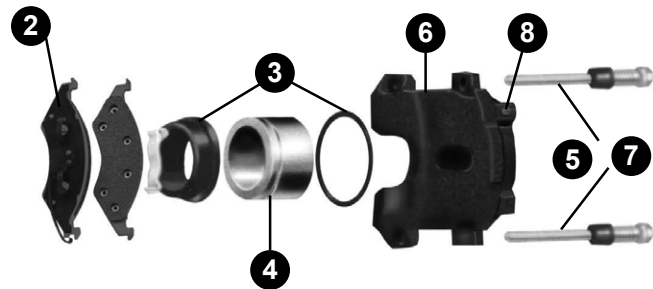

El rotor o disco es un componente que está expuesto a alta temperatura generada por fricción. Suele estar montado, al igual que las balatas, donde el aire puede enfriar más rápidamente las partes. Fabricados con diferentes materiales, los tipos de rotores, ya sean sólidos y/o ventilados van de acuerdo a la especificación y diseño de fabricante del vehículo.

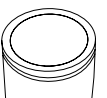



Espesor del rotor

Generalmente todos los discos o rotores tienen grabado o quintado el mínimo espesor que debe ser usado durante su vida útil.

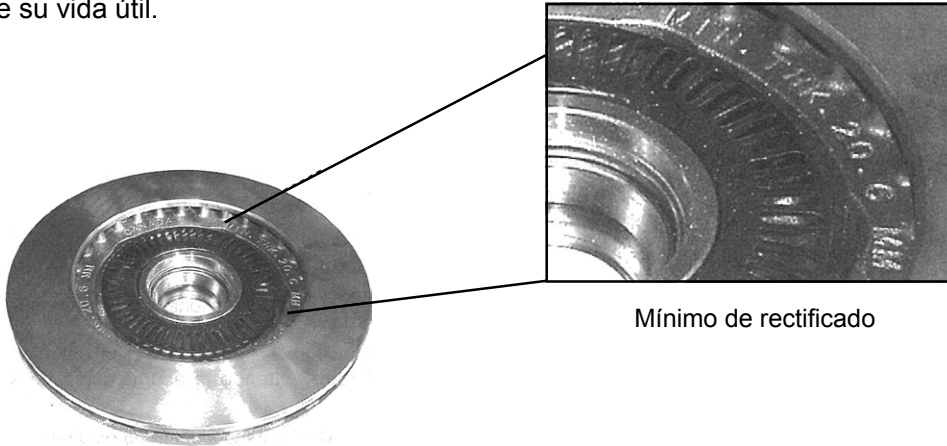

Mínimo de rectificado

Es necesario realizar las mediciones y revisiones pertinentes para un mejor desempeño, ya que un disco o rotor fuera de especificaciones genera problemas en el sistema de frenos tales como: desgaste prematuro de balatas, rechinido, vibración al frenar, entre otros.



Rotor ventilado

Es necesario revisar que el rotor no tenga puntos duros, rayaduras (surcos), señal de sobrecalentamiento (disco de color azul), fracturas, así como contaminación por grasa.

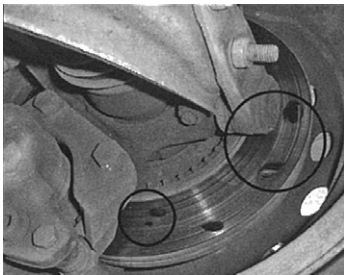

Puntos duros



Rayaduras



Fracturas

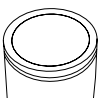



Pistón

Fabricado de baquelita, aluminio o hierro, es el componente que, a través de la presión hidráulica, comprime las balatas contra el disco o rotor. El rotor está unido a la rueda y la detiene.

Se recomienda sustituir los pistones de baquelita (resina fenólica) por pistones de aluminio por ser más ligeros y resistentes a altas temperaturas.



Pistón de baquelita



Pistón de aluminio



Pernos

Son los elementos que sujetan la mordaza en el porta caliper, utilizados generalmente en el caliper deslizante y protegido por bujes de hule, manteniendo una perfecta alineación del caliper con la superficie del rotor.

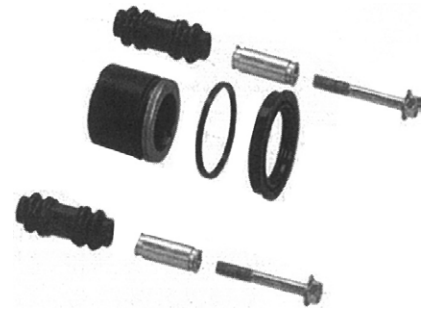

Pernos

Herrajería

Se denomina herrajería de frenos ya sea de disco o tambor al conjunto de resortes, bujes, chicotes, seguros, laines antirruído y pernos. Este grupo de componentes sirven para mantener una buena o perfecta alineación entre el material de fricción y el rotor o disco.

El buen estado de estos componentes nos ayuda a obtener una máxima duración de las balatas y evitar el desgaste prematuro de las mismas y ruidos.

En los frenos de tambor nos ayuda a mantener una perfecta separación entre las balatas y el tambor. Asimismo evita traqueteos y mal funcionamiento en los mismos.

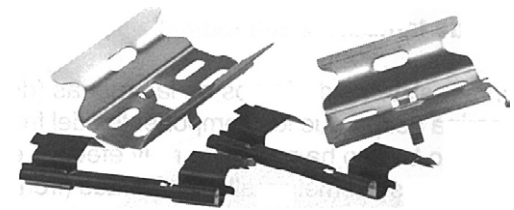

Lainas antirruído

Tornillo purgador

Es la válvula de escape para liberar el aire que se encuentra en el sistema de frenos asimismo, nos sirve para reemplazar el líquido para frenos cuando sea necesario.



Tornillo purgador

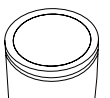



Calipers

Actualmente el freno de disco en el parque vehicular nacional, utiliza tres diferentes tipos de calipers (mordaza).

Fijo

Contiene dos pistones, uno a cada lado del rotor. Cuando se oprime el pedal de freno, el líquido para frenos fluye del cilindro maestro hacia la parte trasera del pistón del caliper, lo que fuerza las balatas contra el rotor.

Una característica de estos calipers es el uso de pernos de retención para sujetar las balatas.

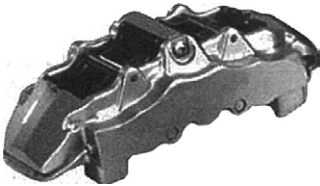

Deslizante

A diferencia del flotante, este caliper no utiliza tornillos como sujeción.



Flotante

En este tipo de diseño, el caliper completo se mueve cuando el pistón es empujado fuera de éste durante la aplicación del freno. Cuando el caliper se mueve, la balata exterior es empujada contra el rotor.

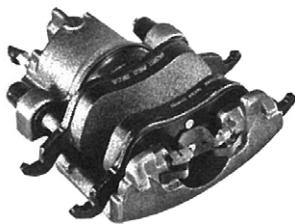

Electrohidráulico

Los calipers traseros son electrohidráulicos (componentes hidráulicos y eléctricos) los cuales cuentan con actuadores que funcionan al aplicar el freno de estacionamiento presionando las balatas contra el disco en condiciones de estacionamiento, al liberar la palanca del freno los motores giran en sentido contrario a las manecillas del reloj, liberando la presión ejercida a las balatas vs. el disco provocando una separación de 0.005" lo que permite el desplazamiento del vehículo.

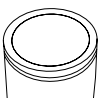



Freno de tambor

El primer sistema de frenos en las ruedas (después de los frenos de mano) fue el de tambor, el cual se denomina así porque los componentes del freno se encuentran dentro de un cilindro en forma de tambor. Su diseño básico ha resultado muy efectivo en muchas circunstancias, sin embargo tiene la desventaja que cuando se somete a altos esfuerzos (frenadas en bajadas prolongadas) los frenos pierden efectividad debido a que se genera demasiado calor dentro del tambor y poca ventilación, lo que impide reducir la velocidad.

Realice una inspección visual en el tambor antes de hacer cualquier reparación y verifique el máximo diámetro antes de enviar a rectificar, reemplazar y conformar las balatas.

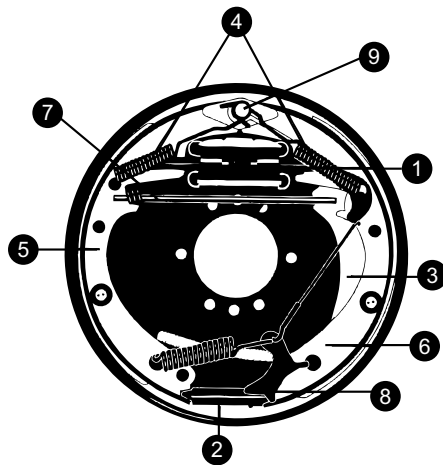

Componentes del freno de tambor

1. Cilindro de rueda
2. Tornillo ajustador
3. Palanca de freno de estacionamiento
4. Conjunto de resortes
5. Balata primaria
6. Balata secundaria
7. Separador de zapatas del freno de estacionamiento
8. Leva ajustadora
9. Punto de anclaje

Existen dos tipos de freno de tambor:

Tipo servo

El freno de tambor de tipo servo se utiliza en vehículos de 4, 6 y 8 cilindros, funcionando en forma de cuña al ser accionado, gracias a que las balatas que son usadas en este sistema son una corta (primaria, 30% proporción de frenado) y una larga (secundaria, 70% proporción de frenado).

Una de sus características principales es el desfase de las zapatas desde el punto de anclaje, la diferencia que existe entre el freno de tambor tipo servo es la ubicación del tornillo ajustador en la parte opuesta al cilindro de rueda, y el tipo no servo el tornillo de ajuste se encuentra junto al cilindro de rueda.

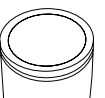
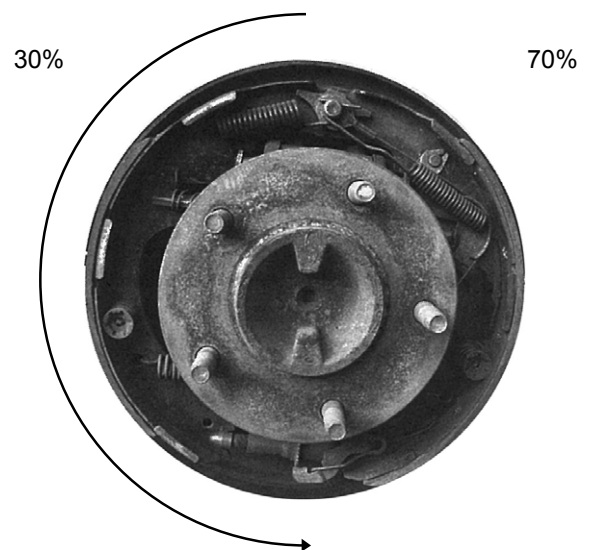



70%

30%

Tipo no servo

El freno de tambor tipo no servo generalmente es usado en vehículos compactos de tracción delantera; a diferencia del tipo servo, las balatas tienen la misma longitud (tamaño) y se encuentran fijas en su punto de anclaje contrario al cilindro de rueda; además de que la balata primaria ejerce el 70% de frenado y la balata secundaria el 30%. Al igual que los rotores o discos, los tambores tienen grabado el máximo diámetro con el que pueden ser utilizados.

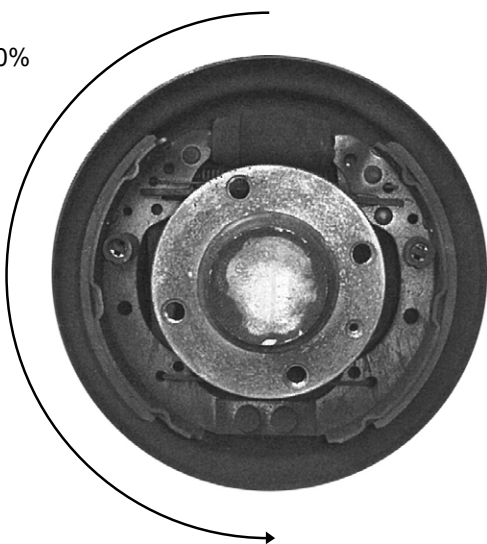

Freno de estacionamiento

El freno de estacionamiento tiene sus orígenes antes de 1967, cuando casi todos los vehículos utilizaban cilindros maestros de un solo pistón que accionaba los frenos de las cuatro ruedas; si el líquido se fugaba en una rueda se perdía el funcionamiento del sistema de frenos, por lo que requería de un método independiente para detener el vehículo en caso de emergencia.

Después de 1967 se reglamentó el uso de cilindros maestros dobles, donde la mitad del sistema de frenado era independiente. En caso de alguna falla, una lámpara de advertencia en el tablero se encendería indicando que ha ocurrido un desperfecto.

El término “Freno de estacionamiento” ha reemplazado al término “Freno de emergencia” desde el uso de los cilindros maestros dobles.

Siempre que se emplea el freno de estacionamiento se enciende la luz roja del BRAKE en el tablero de instrumentos, en casi todos los vehículos esta misma lámpara se enciende cuando existe un problema hidráulico o de nivel de líquido para frenos.

Esta lámpara de advertencia indica al conductor cuando el freno de estacionamiento está parcialmente o totalmente aplicado, para evitar daños o sobrecalentamiento a las balatas.

En vehículos de General Motors la luz roja de advertencia también indica códigos de falla del ABS según la brillantez.

Los frenos de estacionamiento se pueden aplicar por medio de una palanca manual o un pedal que se acciona con el pie, se utilizan cables de acero protegidos por un recubrimiento de plástico denominado “funda”.



Pedal del freno de estacionamiento



Palanca manual

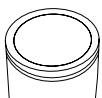



Baleros

Uno de los baleros más utilizados en la industria automotriz es el de rodillos cónicos, el cual está diseñado para aceptar el empuje axial y radial, y debe recibir mantenimiento con regularidad. Una instalación inadecuada puede disminuir la duración de los baleros, dañar la maza del vehículo y afectar la estabilidad del frenado.



Retén de grasa

Una de las partes más importantes y a la vez más ignoradas al dar servicio completo al sistema de frenos es el retén de grasa del balero. Su trabajo es retener la grasa o aceite para evitar contaminación en las balatas. Asimismo sirve para evitar la entrada de suciedad, polvo o agua al interior del balero o al lubricante.



Booster

Es el elemento que nos ayuda a multiplicar la fuerza (1 x 6 veces) que aplicamos al pisar el pedal de freno para incrementar la presión hidráulica que va hacia los frenos. Casi todos los reforzadores de frenos de potencia trabajan con vacío, que se obtiene del múltiple de admisión del motor. Un vacío es una presión inferior a la atmosférica y se mide en milímetros de mercurio o pulgadas de mercurio. Contiene 1 o 2 diafragmas de hule conectados al pedal de freno en un extremo y por el otro extremo al cilindro maestro, siendo éste un equipo de norma para todos los vehículos equipados con o sin frenos ABS.

Existen tres tipos de booster:

Tipo suspendido en vacío

El cual es alimentado por vacío del motor (15 a 20 pulgadas de vacío). Contiene un diafragma de hule conectado al pedal del freno en un extremo y por el otro extremo al cilindro maestro.

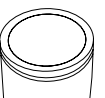
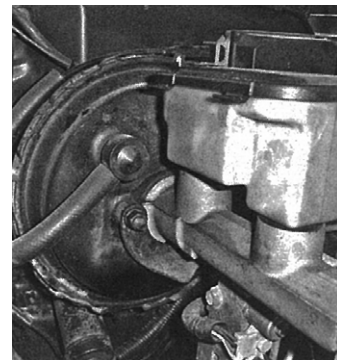



Tipo doble diafragma

El método usual para aumentar el área del diafragma de vacío era incrementar el diámetro del reforzador de vacío. Sin embargo ocupaba demasiado espacio bajo el cofre, así que en su lugar, los fabricantes usaron dos diafragmas de diámetro más pequeños y colocaron uno delante del otro, este diseño aumentó el área total sin incrementar el diámetro físico del reforzador.

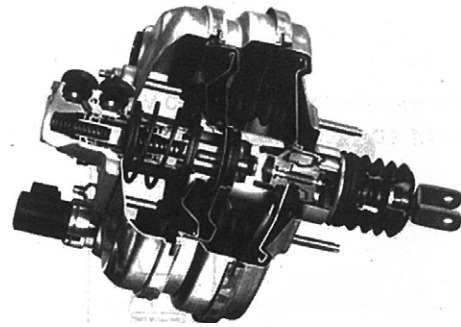

Hidrobooster

Es una unidad de asistencia por potencia accionada hidráulicamente. Utiliza el fluido hidráulico con sobrepresión de la bomba de dirección hidráulica del vehículo como fuente de energía, en vez de vacío como se usa en reforzadores de vacío.

Válvulas hidráulicas

Existen tres tipos de válvulas hidráulicas usadas en los sistemas de frenos: válvula repartidora, válvula de proporción y válvula sensora de carga (de altura).

Válvula repartidora (combinación o triple)

La encontramos como equipo de norma en vehículos de tracción trasera, el objetivo de esta válvula es modular igual presión tanto al circuito trasero como al circuito delantero, cuando se aplica ligeramente el pedal del freno.

Formada por tres válvulas:

1. Válvula de proporción (válvula de control de presión)

Permite que se envíe presión del cilindro maestro de máximo 300 PSI, ya que arriba de esta presión se reduce el volumen de las ruedas traseras evitando el bloqueo de las mismas al limitar la cantidad de presión que se envía.

Los vehículos equipados con división diagonal emplean una válvula para cada freno trasero. Entiéndase que son dos unidades por separado.

Nota: No retire las válvulas de proporción, cuando estén dañadas reemplácelas si es necesario.

2. Válvula de presión diferencial

La función de esta válvula es la de monitorear la pérdida de presión en cualquiera de los circuitos hidráulicos del sistema de frenos. Una caída de presión ocasiona que se prenda la luz roja de advertencia.

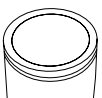



3. Válvula métrica

Se usa en casi todos los vehículos de tracción trasera y es la encargada de retener por fracción de segundos la presión hidráulica hacia las ruedas delanteras cuando es generada una frenada de emergencia, permitiendo se activen primero los frenos traseros. Esto permite la aplicación simultánea de los frenos traseros y delanteros para lograr un frenado parejo.

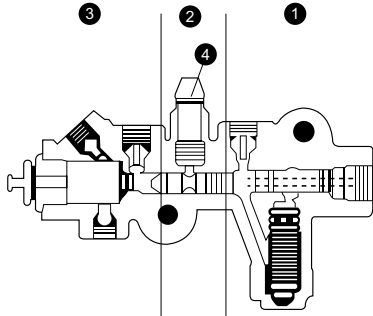

Componentes de la válvula triple

1. Válvula proporcional
2. Válvula de presión diferencial
3. Válvula métrica
4. Interruptor de presión diferencial

Válvula sensora de carga (de altura)

Instalada en la parte trasera del chasis del vehículo y conectada por medio de una leva al eje trasero, muchos vehículos usan una válvula de proporcionalamiento que modifica la presión hacia los frenos traseros de acuerdo con la altura de la suspensión. Si el vehículo tiene carga ligera, la suspensión estará alta especialmente durante el frenado, en este caso se reduce la cantidad de presión a los frenos traseros evitando que se bloqueen, por lo contrario cuando se carga un vehículo, la suspensión trasera se fuerza hacia abajo, obligando a la leva de la válvula a moverse hacia arriba para permitir una mayor presión de líquido hacia los frenos traseros, generando un mayor poder de frenado.

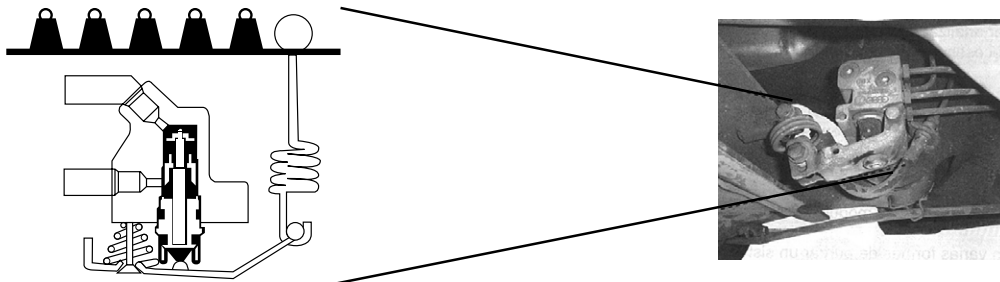

Líquido para frenos

Es el transmisor de fuerza desde el cilindro maestro hasta los calipers y cilindros de rueda por medio de mangueras y tuberías, para producir movimiento en los componentes mecánicos y de fricción. Existen líquidos para frenos en tres clasificaciones:

Líquido para frenos, factores y su punto de ebullición:
DOT 3 - Base en glycol 206°C, 95% de los vehículos.

DOT 4 - Base en glycol 236°C, 3% de vehículos como Honda y Mitsubishi.

DOT 5 - Base en silicón 350°C, 2% de vehículos como BMW, Mercedes Benz, maquinaria para la construcción de carreteras.

El líquido para frenos puede tener una versión para trabajo pesado con un punto de ebullición más alto.

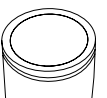



Los recipientes del líquido para frenos deberán permanecer cerrados ya que es higroscópico, lo cual quiere decir que absorbe la humedad y ocasiona oxidación, corrosión y sedimentos, provocando restricción en los canales del ABS.

Se recomienda revisar el líquido para frenos cada dos años en vehículos de frenos convencionales y cada año en vehículos equipados con ABS.

Asimismo obtener una muestra del líquido del vehículo en el cual estamos trabajando para ser analizado, con la intención de determinar si es necesario reemplazarse.

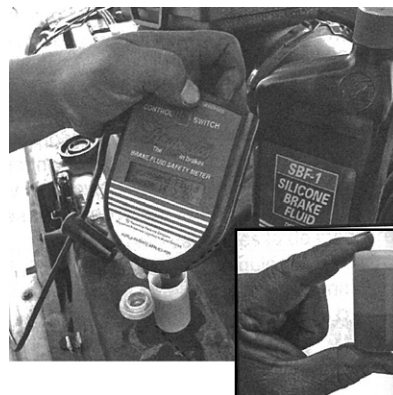

Purgado del sistema de frenos

Purgar los frenos es eliminar del sistema hidráulico todo el aire atrapado. Se puede introducir aire en el sistema hidráulico siempre que se abre una conexión de la tubería o la unidad de frenos hidráulicos (cilindro maestro y/o el modulador hidráulico del ABS).

Existen varias formas de purgar un sistema de frenos pero no todas son efectivas ni recomendables.

Purga manual

La purga manual es el proceso de aplicar presión (con la ayuda de otro mecánico) al pedal del freno, mientras se abre ligeramente la válvula de purga (purgador), de esta forma se aplica presión sobre el líquido que es forzado a salir junto con el aire a través del tornillo purgador.

Purga con presión

Es un método en el que se aplica presión al sistema hidráulico por el cilindro maestro, utilizando un tanque de presión formado por dos cámaras, una para líquido y una para aire, que se encuentran separadas por un diafragma de hule. Éste último es cargado con aire comprimido para que el líquido fluya al abrir la válvula de alimentación, una vez instalado el adaptador necesario. Este tipo de purga es sumamente efectiva y sólo requiere de una persona para poder realizarse.

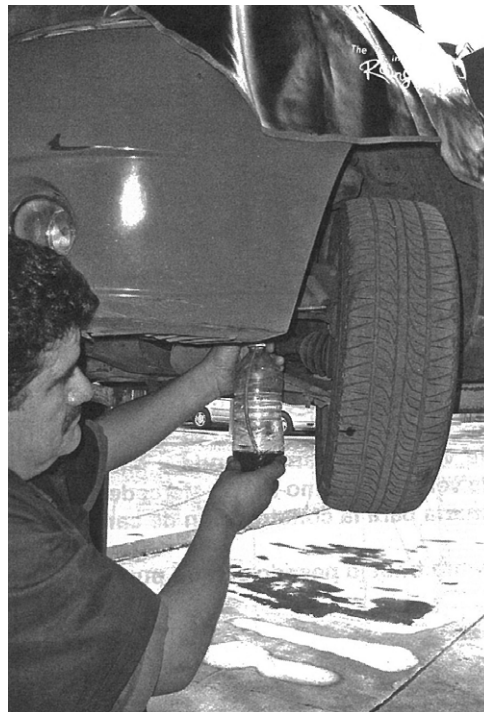

Al presionar el pedal se abre el tornillo purgador

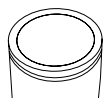

Purga con vacío

Otro purgado muy popular entre los técnicos es con una bomba de vacío (manual o eléctrica) para aspirar el líquido a través del purgador e introducirlo en un recipiente. Este tipo de purgado se puede realizar sin la necesidad de otro técnico.

Purga por gravedad

Se realiza abriendo el purgador dejando que el líquido fluya por sí sólo, este método de purga no es recomendable ya que puede generar grandes problemas en el sistema de frenos.

Purga de flujo continuo

Este método se lleva a cabo con dos personas, una de ellas presionará el pedal del freno para generar presión en el sistema hidráulico y forzar a que el líquido y el aire salgan por el orificio donde se instala el purgador. Se realiza de la siguiente manera:

1. Se pisa el pedal del freno hasta el fondo, y sin soltarlo se retira el tornillo purgador.
2. Una vez retirado se coloca el dedo pulgar (funciona como válvula de alivio ya que permite la salida del fluido y el aire, pero no permitirá que se introduzca aire al sistema de frenos).
3. Se procede a bombear el pedal del freno durante quince veces haciendo una pausa de cinco segundos con el pedal arriba entre cada pisada.
4. Una vez concluidos los quince bombazos se presiona el pedal a fondo y sin soltarlo retiramos nuestro dedo y se coloca el tornillo purgador. Esta operación se realizará en las tres ruedas restantes. Es necesario que revisemos constantemente el nivel del líquido para frenos cuidando que no llegue a estar vacío.

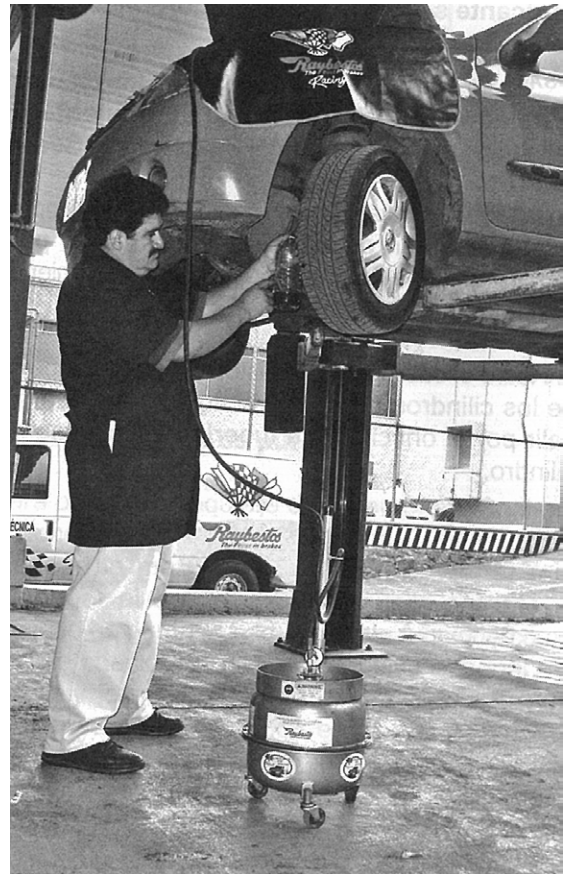

Purgado con tanque de purga a presión

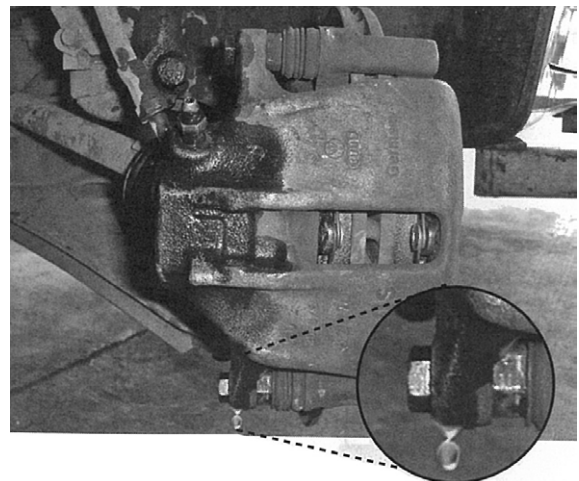

Purgado por gravedad

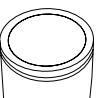



Purgado de cilindro de rueda VW Sedán

Como todos sabemos al modelo Volkswagen Sedán de los años 92, 93 y 94 con frenos de tambor en las 4 ruedas, por diseño del fabricante, se le colocó un cilindro maestro de doble pistón. El siguiente tip es para la purga de frenos del Volkswagen Sedán.

En las ruedas delanteras sabemos que los cilindros de rueda están colocados verticalmente, para lograr una purga rápida y adecuada, se recomienda el siguiente procedimiento:

1. Retire el cubrepolvo, el pistón y la goma superior de los cilindros de rueda, el líquido empezará a salir por el orificio de la tubería hasta el ras del cilindro.
2. Sumerjamos la goma en el cilindro en forma vertical, ya cubierta la goma con líquido para frenos le vamos a ayudar empujándola con el dedo para que se acomode en su posición correcta.
3. Coloquemos el pistón y el cubrepolvo. La rueda delantera estará purgada correctamente.

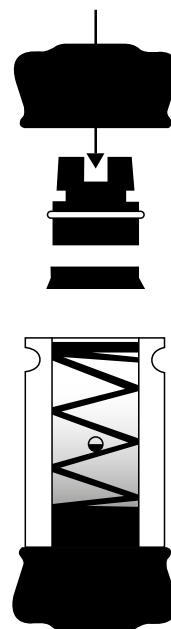

4. El siguiente paso es colocar las balatas, resortes y tambor de la rueda ya que el cilindro está purgado al 100%. Repitamos la misma operación en la otra rueda delantera.

5. Para las ruedas traseras, con el pedal pisado a fondo quitamos el tornillo purgador y en el orificio donde va éste, colocamos nuestro dedo, el cual deberá mantener presionando durante todo el proceso.

Posteriormente, la persona que está al volante presionando el pedal del freno bombeará 15 veces este dejando espacios de 5 segundos entre cada pisada; es decir, pisar y soltar el pedal del freno y esperar 5 segundos para repetir la operación.

Esto nos ayudará a limpiar las tuberías de frenos. Una vez concluidas las 15 repeticiones, sin soltar el pedal del freno, retire el dedo y coloque el tornillo purgador.

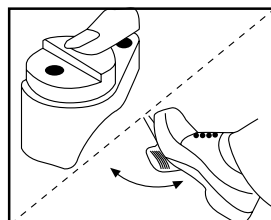
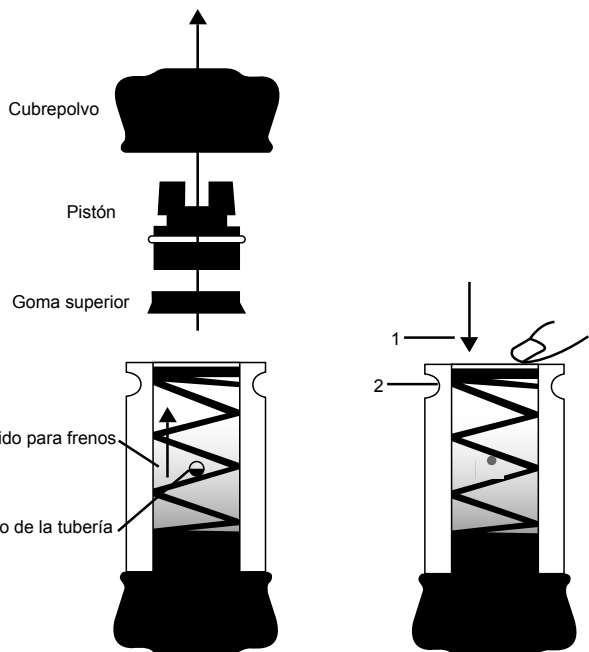

Recordemos que el líquido para frenos lo tenemos que cambiar mínimo cada año.





Purgado de los cilindros de embrague hidráulicos

Las recomendaciones para un mejor purgado son las siguientes:

1. Llenado del cilindro de clutch

Se recomienda previamente llenar el cilindro al ras con líquido para frenos por medio de una jeringa, ya que la mayoría de éstos no cuentan con tornillo de purga. Este llenado debe ser con el cilindro de clutch inferior en posición vertical.



Llenado del cilindro de clutch en posición vertical



2. Procedimiento de purga

Para purgar se requiere de 2 personas. Se llena el depósito con líquido para frenos, una persona taponea la manguera en la parte inferior (sin despegar el dedo de la manguera durante el proceso de purgado para que éste funcione como válvula check), la otra persona pisa el pedal del clutch y lo acciona por 15 veces, dejando un descanso de 5 segundos entre cada bombeo.

Transcurridos los 15 bombeos el pedal del clutch debe quedar oprimido.

3. Conectar la manguera en el cilindro inferior de clutch previamente purgado

Una vez conectada la manguera podrá soltar el pedal de clutch. Al efectuar estos sencillos pasos su purga estará bien realizada sin problemas de aire, además de que se aprovecha el cambio de líquido sucio por nuevo.

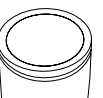
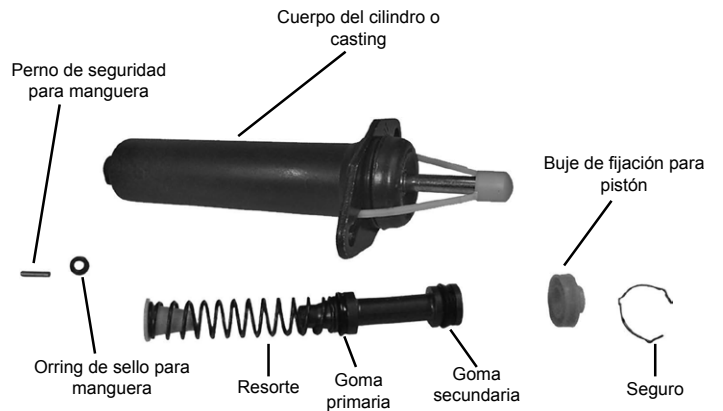



Frenos ABS

El sistema de frenos antibloqueo (ABS) ha estado presente por décadas, pero de diferente forma a como lo encontramos en los vehículos actuales. La aplicación de los frenos ABS era exclusiva de los vehículos deportivos y/o tuning.

En la actualidad, el ABS es opcional en algunos vehículos de acuerdo al equipo de seguridad. Es un sistema muy confiable, completamente automático y nos ayuda en situaciones de conducción peligrosa.

Usted como técnico en frenos encontrará diferentes sistemas de frenos antibloqueo como: Bendix, Kelsey-Hayes, Teves, Delco, Delphi y Bosch.

El objetivo de todo sistema de frenos es detener cualquier vehículo en movimiento completamente cuando el conductor lo requiera. Esta acción se lleva a cabo cuando el líquido presurizado llega a un conjunto de freno de rueda y lo que se consigue cuando el pedal del freno es aplicado, una vez que se suelta el pedal, el líquido también es liberado en el freno.

Para lograr este objetivo es necesario tomar en cuenta los siguientes puntos:

1. Coeficiente de fricción
2. Condición de las llantas
3. Condición del camino
4. Velocidad del vehículo
5. Tamaño y peso del vehículo

Función del sistema de frenado antibloqueo

Durante una frenada de pánico (emergencia) las ruedas del vehículo pueden bloquearse, provocando que el conductor pueda perder el control del vehículo, representando una situación de conducción peligrosa; el grado de bloqueo se llama deslizamiento y esto ocurre cuando la velocidad del giro de la rueda es menor que la velocidad del vehículo.

El ABS mantiene el deslizamiento necesario de la rueda (15% al 30% aproximadamente) para desacelerar efectivamente un vehículo mientras evita el total bloqueo de la misma.

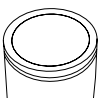
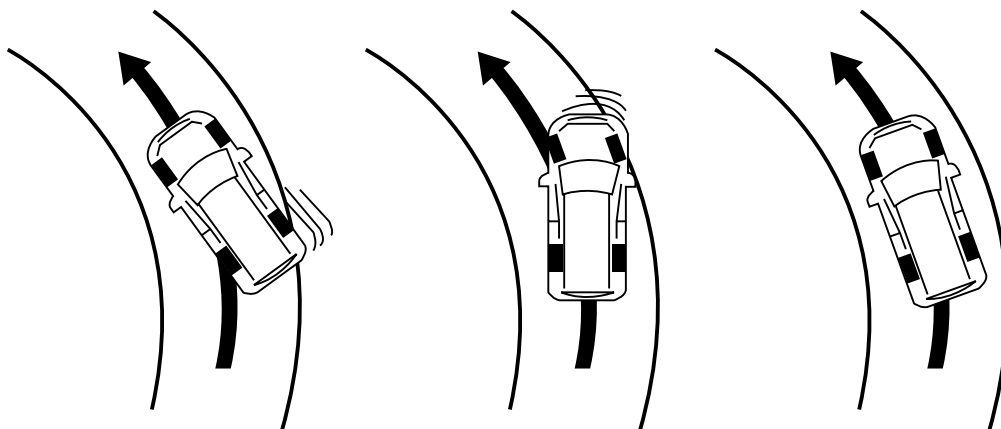



Los factores que afectan el deslizamiento de la rueda son los siguientes:

1. **Coefficiente de fricción** (camino, condición de la llanta y velocidad del vehículo).
2. **Condición de los componentes del freno.**
3. **Frenado controlado por el conductor.**

Sin ser pensado de esta manera, bombear los frenos es el propósito de conservar la estabilidad direccional.

Las acciones siguientes ocurren cuando se aplica presión de frenado y se bombean los frenos:

- La presión aumenta
- Se mantiene la presión
- La presión disminuye

Dicho de otra forma, al aplicar los frenos y al mantener el pedal oprimido, en ese momento se mantiene la presión.

En el momento que el vehículo está perdiendo el control direccional, o el pedal está demasiado bajo, se suelta el pedal del freno. En ese momento la presión de frenado disminuye y el pedal se eleva.

Cuando se recupera el control del vehículo se vuelven a aplicar los frenos, en ese momento se incrementa la fuerza de frenado o presión, este procedimiento (aplicación, liberación, aplicación) continúa hasta que el vehículo desacelere a una velocidad segura.

Si alguna vez ha tenido que frenar su vehículo bombeando los frenos es probable que no pensó que ocurrían las acciones antes descritas.

Control automático

En un vehículo equipado con ABS el conductor sólo necesita aplicar el freno y conducir el vehículo, ya que las acciones de bombeo las realiza automáticamente el sistema.

Los componentes del ABS realizan esto por nosotros, el sistema detecta cuando es necesario aplicar presión de frenado, mantenerse constante o liberarse.

El sistema calcula el deslizamiento de una rueda en el frenado, si una rueda se bloquea se activa el ABS.

El ABS se divide en tres subsistemas:

Sensores de velocidad

Estos sensores electromagnéticos producen una señal de velocidad para el controlador electrónico.

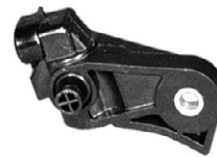

Sensor discreto



Sensor integral

Unidad electrónica de control

Un controlador electrónico de freno antibloqueo (CAB) monitorea la señal del sensor(es) de velocidad de las ruedas y controla a la unidad de control hidráulico, cuando hay una tendencia de bloqueo o disminución brusca de velocidad de una o más ruedas se activa el sistema.

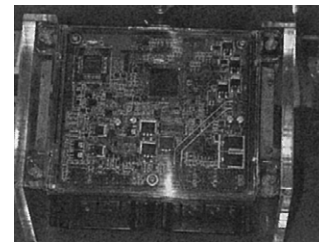

Unidad de control hidráulico

La HCU realiza el verdadero trabajo de controlar la presión del líquido al conjunto de frenos en un frenado de emergencia y así evitar que las ruedas se bloqueen.

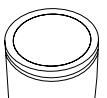
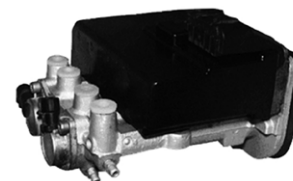



Todas las unidades de control hidráulico (HCU) utilizan válvulas de solenoide, para controlar la presión de fluido en las ruedas.

Lo principal para entender un sistema de freno antibloqueo es observar que el ABS realiza lo antes descrito al bombear los frenos.

El ABS realiza las acciones que a continuación serán descritas en una frenada de pánico.

- Mantiene la presión (sostiene el frenado)
- Disminuye la presión (libera los frenos)
- Aumenta la presión (frenos aplicados o reaplicados)

Sistemas básicos de freno antibloqueo

Sistemas hidráulicos

Existen dos tipos de sistemas hidráulicos que usan diferentes sistemas de freno antibloqueo: el sistema abierto y el sistema cerrado, pero para entender bien estos es necesario que conozca acerca de las válvulas de control que se utilizan en el ABS.

Las válvulas que se usan en el ABS realizan las acciones de bombeo que se describió con anterioridad, según el sistema específico usado, trabajan juntas para controlar el líquido para frenos en paradas de emergencia.

Lo interesante es recordar que no importa que sistema sea, la operación del ABS dependerá de la habilidad de retener, liberar o incrementar la presión en los frenos.

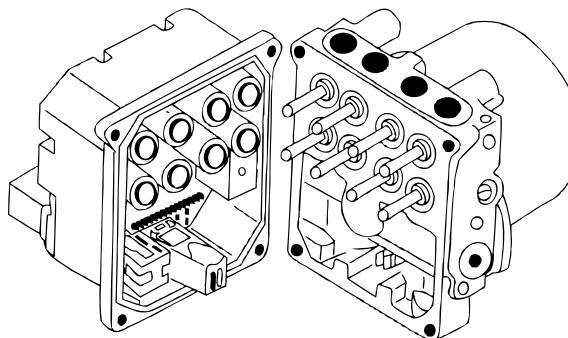

Válvulas y solenoides

Existen tres tipos de válvulas de control que puede encontrar en algunos sistemas de freno antibloqueo:

- Válvulas de aislamiento o de entrada - normalmente abiertas, energizadas para bloquear.
- Válvulas de incremento - normalmente cerradas, energizadas para aplicar presión.
- Válvulas de disminución o de salida - normalmente cerradas, energizadas para liberar presión.

Algunos sistemas antibloqueo pueden tener los tres tipos de válvulas y otros no.

Durante la acción del frenado ABS, la unidad electrónica modula las válvulas energizando los solenoides que controlan a éstas. La palabra "modula" significa que las válvulas cambian muy rápidamente.

Válvula de aislamiento

Es una válvula normalmente abierta que es operada por un solenoide. Durante el frenado normal, permite que la presión del líquido para freno entre a la unidad de control hidráulico desde el cilindro maestro.

Cuando ocurre un frenado antibloqueo el solenoide se energiza o desenergiza, como lo manda el CAB.

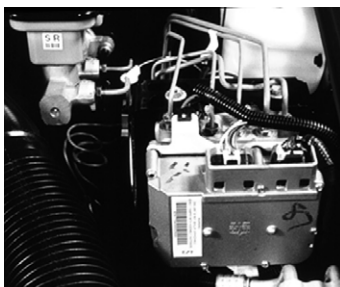

Frenos ABS tipo no integral o abierto

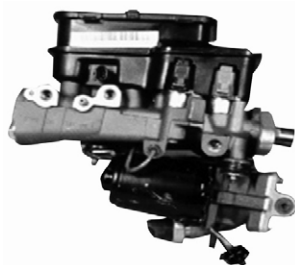

Frenos ABS tipo integral o cerrado

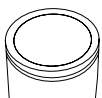



Válvula de disminución

También llamada de salida, es una válvula normalmente cerrada operada por un solenoide.

En un frenado normal permite que el líquido fluya desde la Unidad de Control Hidráulico al conjunto de freno de rueda. Durante un frenado antibloqueo, el solenoide se energiza o desenergiza como lo mande el CAB.

La válvula cambia la presión del resorte al energizarse el solenoide. Entonces el líquido desde la rueda afectada fluye dentro de la línea de retomo. Esta acción ocasiona que el frenado de la rueda aumente o disminuya.

Tipos de sistema

- Sistemas abiertos
- Sistemas cerrados

En la activación del ABS, la presión del líquido es modulada en tres ciclos:

1. Retener o mantener presión
2. Disminuir o liberar presión
3. Incrementar o aumentar presión

La modulación del líquido es similar a bombear los frenos. En el ciclo de incremento, es necesaria una fuente para el incremento rápido de presión que se requiere para aplicar la acción de frenado a una rueda.

Teniendo la capacidad de entender los dos tipos de sistemas hidráulicos, usted puede determinar de donde viene la presión del líquido.

Sistemas abiertos (no integral)

En los sistemas abiertos la principal característica es que en una operación antibloqueo, la presión a realizarse es provista por los puertos primario y secundario del cilindro maestro.

En el funcionamiento del ABS, el cilindro maestro es la fuente de presión en el sistema hidráulico.

En el ciclo de retención la válvula de entrada bloquea el líquido, para evitar que llegue al freno de la rueda afectada y dé la sensación de pedal duro, como consecuencia del movimiento de los pistones del cilindro maestro, los cuales están restringidos durante el ciclo de retención.

A un depósito están conectadas las válvulas de salida, en el ciclo de disminución se abren y liberan la presión en los frenos de las ruedas. El líquido que fue liberado fluye al depósito.

En el ciclo de incremento, las válvulas de entrada se abren y las válvulas de salida se cierran, para que de esta manera el líquido del cilindro maestro sea aplicado al freno de la rueda afectada. El pedal de freno puede bajar rápidamente en ese momento.

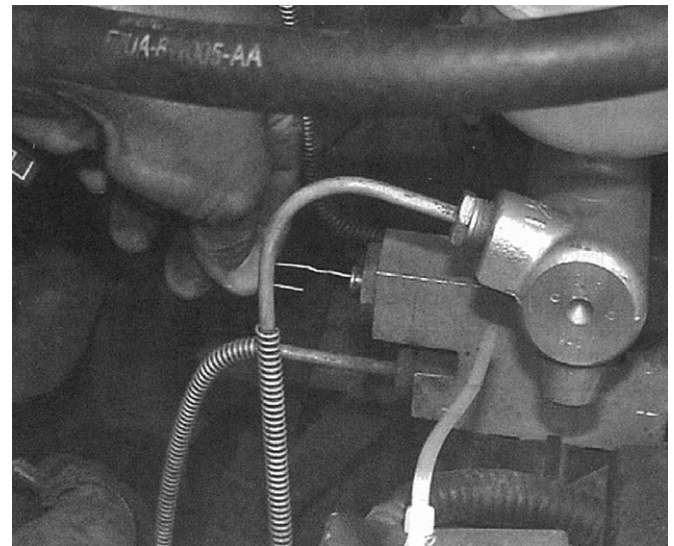

Sistema abierto

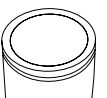



Sistemas cerrados

Una bomba y un acumulador suministran la presión para una operación antibloqueo.

Existen dos tipos de sistemas cerrados:

1. Hidroreforzado.
2. No hidroreforzado.

PRECAUCIÓN

Al trabajar con este tipo de sistemas debe seguir las siguientes recomendaciones: desconecte la batería, es necesario bombear la presión en el sistema para bajarla antes de desconectar una línea de presión. Aplique los frenos de 40 a 50 veces hasta que el pedal se sienta “duro”, para reducir la presión del líquido en el acumulador, reforzador, bomba y líneas, ya que la presión con la cual funciona este sistema es de 2600 PSI.

Hidroreforzado

En la activación del ABS de este sistema, el cilindro maestro se independiza del sistema de freno por el cerrado de las válvulas de aislamiento.

Un circuito de servo de refuerzo es la fuente de presión. Este es alimentado por una motobomba y un acumulador.

En el ciclo de retención las válvulas de incremento son cerradas y la presión generada por la bomba se almacena en un acumulador.

En el ciclo de disminución, el líquido liberado regresa al depósito del cilindro maestro.

Esto ocurre en un ciclo de incremento: se abre la válvula de incremento, la presión es liberada desde el acumulador y bombeada por el servo de refuerzo a los frenos de las ruedas.

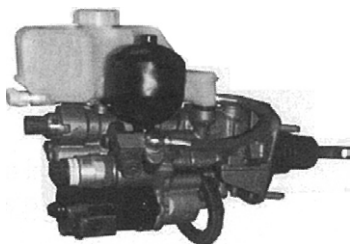

Sistema abierto hidroreforzado

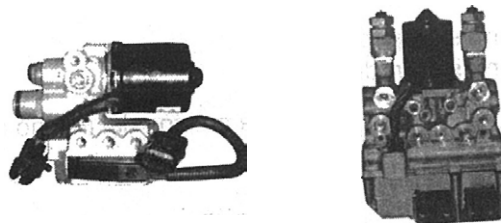

Sistemas cerrados no hidroreforzados

No hidroreforzado

En este tipo de sistemas siguen siendo los acumuladores la fuente de presión.

Un acumulador alimenta el circuito primario y otro el circuito secundario. Este sistema carece de un circuito de refuerzo.

En el ciclo de retención, por el cierre de las válvulas, la presión se bloquea desde la bomba hacia las ruedas, en la disminución el líquido liberado se dirige a los acumuladores. En el ciclo de incremento, las válvulas de entrada se abren, y las de salida se cierran. El líquido a presión generado por la bomba es aplicado a los frenos y se vacía el acumulador hasta el siguiente ciclo de retención. Nuevamente se observa que la bomba y el acumulador son los generadores de presión.

Cuando se activa por primera vez el ABS, los puertos primario y secundario del cilindro maestro generan la presión inicial. Durante la operación del ABS el líquido inicial se mantiene en el ciclo de disminución. El volumen del líquido disminuye conforme se llenan los acumuladores.

La bomba nos sirve para volver a llenar el líquido perdido en el ciclo de disminución y esto también es lo que mantiene al pedal en su posición.





Cilindro maestro con hidroreforzador

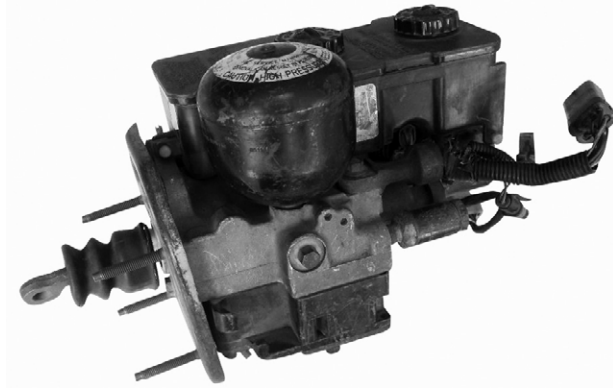

Los autos equipados con este componente en el ABS, cuentan con un cilindro maestro que contiene una válvula de control de refuerzo. Al aplicar el freno, una varilla de empuje aplica presión a la válvula de control de refuerzo, cuando ésta se mueve permite el paso del líquido presurizado desde el acumulador dentro de la cámara del reforzador del cilindro maestro.

El pistón primario es alimentado por la presión en la cámara del reforzador, moviendo al pistón secundario en el cilindro maestro.

Existen sistemas de:

1 canal, 3 canales y 4 canales tales como: Bendix ABX-4, Delco, Bendix, Bosch, Teves Mark IV, Delphi 7.4, Teves Mark 20 Delphi 7, Kelsey Hayes Delco IV, Teves, Nippon denso y Sumitomo.

Sistemas relacionados con el ABS

Ha pasado mucho tiempo desde que el ABS revolucionó el mundo del automóvil. Por primera vez un sistema electrónico era capaz de actuar más allá del conductor, regulando la frenada para evitar el bloqueo de las ruedas y manteniendo la dirección del vehículo.

Desde entonces este sistema ha sido perfeccionado dando lugar a nuevos modelos aún más seguros, complementado por los siguientes sistemas:

BAS: Sistema de Asistencia de Frenado

EBD: Distribución Electrónica de Frenado

BDC: Control Dinámico de Frenado

ETC: Sistema de Reacción Regulado Electrónicamente

TCS: Sistema de Control de Tracción

ASR: Sistema de Control de Tracción Desconectable

ESP: Sistema de Control de Estabilidad

DSC: Sistema Dinámico de Estabilidad

RSC: Sistema de Control de Tracción Avanzada con Control de Estabilidad

MBA: Sistema de Asistencia de Frenado Mecánicamente

SBC: Sistema de Control de Frenado en Curvas

EDL: Sistema de Bloqueo Electrónico Diferencial



El Bendix 10 se utilizó en vehículos Chrysler de 1991 a 1993

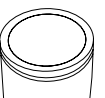



Consejos Técnicos

Consejos técnicos para frenos hidráulicos

1. Llenado de cilindro maestro

Algunos propietarios de vehículos, o personal de servicio sin experiencia, llenan el cilindro maestro hasta arriba. Los cilindros maestros se deben llenar sólo hasta la línea de nivel "MÁXIMO", o hasta ¼ de pulgada debajo de la parte superior, para permitir un espacio para la expansión del líquido para frenos cuando se calienta durante la operación normal del sistema de frenos.

Si el cilindro maestro se llena hasta arriba, el fluido de frenos que tiende a expandirse no tendrá espacio para hacerlo, creando una sobrepresión que causa que los frenos se autoapliquen, además de acortar la vida del material de fricción.

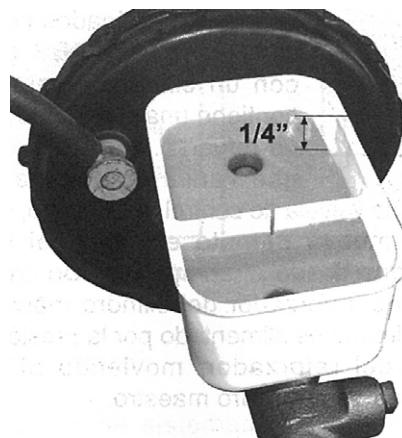

2. Revise siempre el puerto de compensación

Siempre que diagnostique cualquier problema de frenado, inicie el diagnóstico en el cilindro maestro que es el corazón de cualquier sistema de frenado. Quite la tapa del depósito y observe si sale un "chorro" de líquido para frenos cuando un asistente oprima el pedal del freno (operación normal se observa movimiento de fluido en el depósito). Debe haber una emisión de fluido de frenos por el puerto de compensación, tanto en la cámara primaria como en la secundaria.

Esto indica que el puerto de compensación está abierto y que el sello primario es capaz de mover el líquido para frenos hacia arriba a través del puerto, antes que el sello bloquee por completo el puerto de compensación conforme se mueve hacia arriba para poner al fluido en condiciones de alta presión.

3. No se observa movimiento alguno de fluido en el depósito del pistón primario

Esto indica que el líquido para frenos no está siendo desplazado cuando se oprime el pedal del freno. Las causas posibles son:

a) Altura de pedal del freno incorrecta: el ajuste del pedal del freno o de la varilla de empuje podría estar permitiendo que el pistón primario esté demasiado

hacia adelante, lo que causa que el sello esté igual con respecto al puerto de compensación. Ajuste la altura del pedal del freno a un nivel más alto y revise la longitud de la varilla de empuje.

b) Sello defectuoso o hinchado sobre el pistón primario: Esto podría causar que el mismo sello obstruya el puerto de compensación, esto es común cuando accidentalmente se rellena el depósito con aceite o derivados de petróleo.

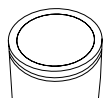
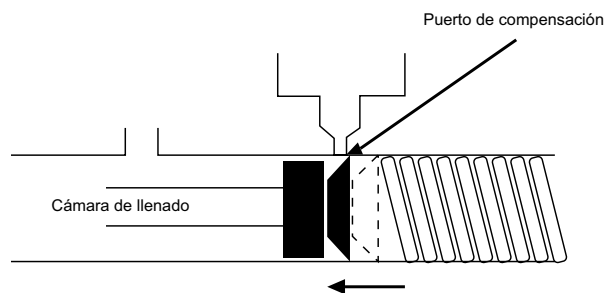

Problemas y causas más comunes en el sistema de frenos

1. Pedal bajo y/o esponjoso:

- Fuga en los sellos del caliper
- Aire en el sistema
- Líquido para frenos contaminado con humedad
- Líquido para frenos de baja calidad
- Nivel de líquido bajo
- Excesiva holgura entre la barra de empuje y el pistón del cilindro maestro (bajo pero NO esponjoso)
- Falso asentamiento en balatas



Líquido para frenos contaminado

Freno de disco

2. Ruido:

- Pérdida de partes de herrajería.
- Herrajería desgastada.
- Balatas excesivamente desgastadas.
- Rotores rayados / mal rectificados / acabado inadecuado.
- Balatas contaminadas.
- Balatas mal instaladas.
- Contacto entre rotor y caliper.
- Falta de lubricación en la herrajería y/o lubricante inadecuado.

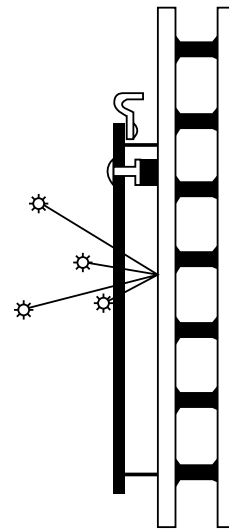

Rechinido de balata

Freno de disco

3. Desgaste disparejo de balatas

- Mecanismo de calibrador pegado.
- Desgaste excesivo en la balata exterior.
- Pistón de calibrador pegado.
- Balata interna desgastada.

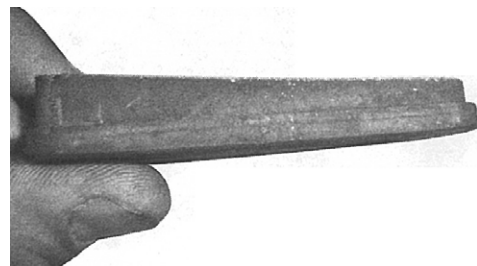

Balata con desgaste disparejo

Freno de disco

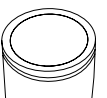



4. Frenos bloqueados

- Pedal del freno atascado o mal calibrado.
- Switch de luz de freno mal ajustado.
- Barra de empuje de booster mal ajustada.
- Pistón de calibrador oxidado, pegado, trabado.
- Manejar con los dos pies (freno/accelerador).

Recomendación para tornillo purgador

Antes de retirar el caliper del soporte, afloje y revise el tornillo purgador para asegurarse que no esté pegado ni tapado.

5. Jaloneo al frenar

- Mangueras para freno obstruidas o dobladas.
- Partes de hule contaminadas.
- Partes de suspensión mal ajustadas o desgastadas.

6. Pulsación en el pedal

- Desalineación lateral en los rotores.
- Falta de paralelismo.
- Variación en el espesor del disco.
- Rectificado excéntrico en rotores y tambores.
- Baleros desgastados.
- Bujes de caliper desgastados.

7. Pedal duro

- Pistones de calibrador pegados.
- Balatas cristalizadas.
- Líneas de vacío del booster bloqueadas.
- Bajo poder de asistencia de vacío.
- Ensamble de booster defectuoso.
- Realizar prueba funcional de booster.

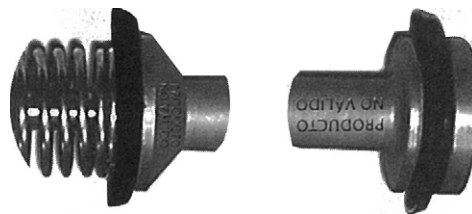

Gomas primaria y secundaria hinchadas



Pedal duro

Servicio al freno de tambor

- Inspeccione el desgaste de las balatas.
- Remueva el herraje.
- Inspeccione los soportes de las balatas.
- Inspeccione los pernos y puntos de anclaje.
- Reconstruya / reemplace los cilindros de rueda.
- Reemplace el herraje cuando cambie las balatas.
- Inspeccione el contacto entre la balata y el tambor.

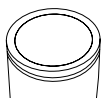
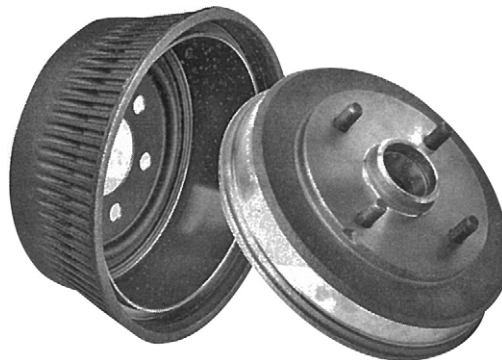



8. Pedal bajo

- Aire dentro del sistema.
- Nivel bajo de líquido en el cilindro maestro.
- Ajuste incorrecto o balatas gastadas.
- Excesivo juego en la varilla de empuje del cilindro maestro.
- Falla en una de las secciones del cilindro maestro.
- Falla en el booster de poder.
- Mangueras deterioradas o débiles.
- Baja calidad del líquido para frenos.
- Pared de soporte flexible en Chevrolet, camionetas Ford y otros.
- Válvula de presión residual del cilindro maestro dañada (si está integrada al cilindro maestro).
- Realice prueba de aislamiento



Manguera desgastada

9. Pedal esponjoso

- Baja calidad del líquido para frenos.
- Aire dentro del sistema.
- Tambores gastados o agrietados que oscilan bajo presión.
- Buje pivote del freno gastado / dañado.
- Realice prueba de aislamiento

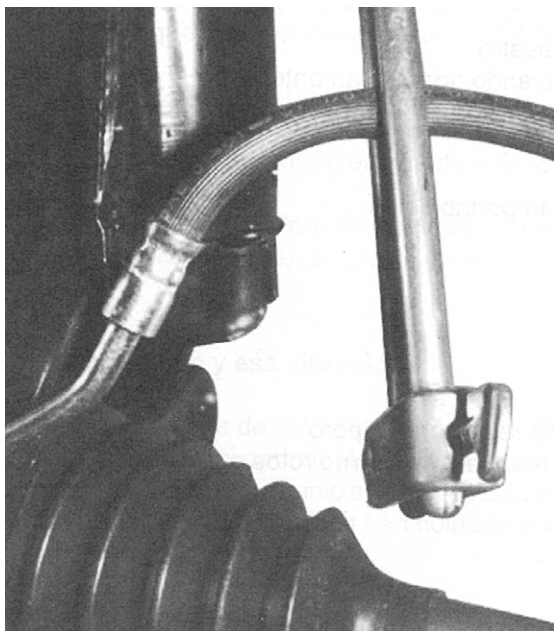

Prueba de aislamiento

10. Pedal que baja lentamente

- Fuga interna en el cilindro maestro
 - Fuga en el cilindro de rueda
 - Cualquier fuga externa
- Realice prueba de aislamiento.

11. Pedal alto

- Ajuste incorrecto de la varilla de empuje del cilindro maestro.
- Balatas sobre-ajustadas (no hay holgura entre la balata y la superficie del tambor).

12. Pulsación del pedal

- Tambor fuera de circunferencia (ovalado).

Cilindro de rueda

Causas	Problemas
-Gomas desgastadas	= Fugas de líquido.
-Óxido/corrosión	= Rechinido.
-Pistones pegados	= Desgaste en balatas y frenado disparejo.
-Ensamble incorrecto	= Problemas hidráulicos y mecánicos.

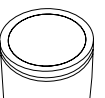



Freno de tambor

13. Pedal duro

- Balatas contaminadas o cristalizadas.
- Mangueras restringidas o dañadas.
- Partes de hule del cilindro maestro o cilindro de rueda contaminadas.
- Falla en el booster de poder.
- Palanca del pedal del freno pegada.
- Manguera del múltiple de admisión al booster de poder con fuga/rota.
- Conector de vacío tapado en el booster de poder.
- Insuficiente vacío.

14. Arrastre o jaloneo al frenar

- Neumáticos desgastados o presión incorrecta.
- Balatas contaminadas.
- Ajuste incorrecto en el freno de estacionamiento.
- Kit de resortes rotos o desgastados.
- El pedal del freno no retorna correctamente.
- Partes dañadas de la suspensión.
- Baleros desajustados en las ruedas.
- Puertos bloqueados o restringidos en las líneas o en el cilindro maestro.

15. Frenos semi-bloqueados / jaloneos

- Ajuste incorrecto de la varilla de empuje del cilindro maestro.
- Líquido para frenos espeso o pegajoso que no está fluyendo adecuadamente.
- Gomas de cilindro de rueda contaminadas.
- Diferentes diámetros de tambor en el eje.
- Tambores ovalados.
- Zapatas de freno trabadas por estar desgastado el plato portabalatas.
- Problemas de suspensión o dirección.

16. Frenos ruidosos

- Golpeteo en las balatas, tambor estrellado o marcas de rectificado áspero.
- Roce de balatas, tambor rectificado fuera de centro o resortes de retorno rotos o vencidos.
- Rechinido por balatas cristalizadas.
- Balatas contaminadas.
- Polvo en los tambores.
- Platos portabalatas torcidos.
- Zapatas distorsionadas.
- Diferente tipo de balatas en el eje.
- Falta de lubricante en la herrajería o en el plato porta balatas.



Lave los frenos de tambor con agua y jabón

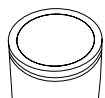



Consejos técnicos para frenos ABS

Ya hablamos de los componentes del Sistema de Frenos Antibloqueo, observamos que el funcionamiento de este sistema es netamente electrónico y complementado por los componentes mecánicos y de fricción. El primer paso para diagnosticar correctamente un problema del sistema de bloqueo es revisar el estado de las lámparas de advertencia, Brake (roja) y/o ABS (ámbar).

Lámpara roja

Advierte una falla o problema en el sistema de frenos convencional, también encenderá si el freno de estacionamiento fue aplicado. Asimismo nos indica que hay un problema de baja presión en un sistema integral o presurizado, en los sistemas RWAL de General Motors nos indicará cuando el sistema antibloqueo tenga una falla de acuerdo a su intensidad (baja intensidad falla ABS, alta intensidad freno de estacionamiento aplicado o problema hidráulico).

Lámpara ámbar

Esta lámpara encenderá después del arranque, durante la secuencia de inicialización o autodiagnóstico, el tiempo exacto que permanece encendida esta lámpara varía de acuerdo al vehículo y el diseño del ABS.

Inspección visual completa

Muchos problemas relacionados con el ABS se pueden diagnosticar con rapidez, si se inspeccionan cuidadosamente los siguientes puntos básicos:

1. Nivel de líquido para frenos. Revise las condiciones del líquido para frenos, así como el nivel.
2. Fugas de líquido para frenos. Revise en busca de fugas las mangueras y otros componentes.
3. Fusible y eslabones fusibles. Revise todos los fusibles que tengan relación con el ABS.
4. Cableado y conexiones. Revise todo el cableado, especialmente los cables de los sensores de velocidad de la(s) rueda(s) en cuanto a daños.
5. Sensores de velocidad. Revise que no esté dañado el arillo (dientes), limpie el sensor si es posible.

Qué es ese ruido y esa vibración Sensor de velocidad

Muchos propietarios de vehículos y técnicos de servicio se han sentido intrigados al escuchar y sentir un ruido ocasional al oprimir el pedal del freno. Se suele escuchar y sentir a través del vehículo luego del arranque y conducción iniciales. Este ruido ocurre cuando se conduce por primera vez para adelante o hacia atrás, muchos técnicos han culpado a la transmisión o componentes relacionados con la línea de transmisión.



Sensor de velocidad

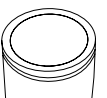



Cómo recuperar códigos de falla para diagnóstico

Después de efectuar una revisión visual completa y luego de verificar la queja del cliente, recupere los códigos de falla para diagnóstico almacenados, relacionados con el ABS.

El procedimiento exacto varía con el tipo de ABS, con la marca, modelo y año del vehículo.

Consulte siempre el manual de servicio de cada vehículo que va a diagnosticar.

Algunos sistemas sólo pueden desplegar códigos de destellos (haciendo destellar la lámpara de ABS o frenos en cierto orden), mientras que otros sistemas pueden efectuar autodiagnóstico y proporcionar la información al técnico mediante una herramienta de diagnóstico (escáner).

En muchos vehículos equipados con doble tracción (4x4), el ABS se modifica y en otros se inhabilita.

Sistemas Kelsey Hayes

En los camiones GM equipados con sistemas RWAL, haga destellar la lámpara del ABS, usando la herramienta de exploración (Tech 1/11) o conecte un cable puente entre la cavidad H y la cavidad A del conector de diagnóstico.

En camiones Ford (RABS) sólo códigos de destello mediante una conexión de puente.

En camiones Chrysler, conecte a tierra las conexiones de diagnóstico.



Multímetro



Punteando las terminales del conector DLC

Diagnóstico de válvula del sistema Kelsey Hayes

Diagnosticando la válvula RWAL

1 a. Generación

1. Retirar la tapa y el resorte del pistón del acumulador hidráulico. Si tiene líquido la válvula, se deberá sustituir.

2. Aplicar el pedal del freno y checar que el pistón del acumulador no tenga movimiento, de lo contrario la válvula se deberá sustituir.

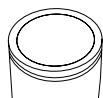
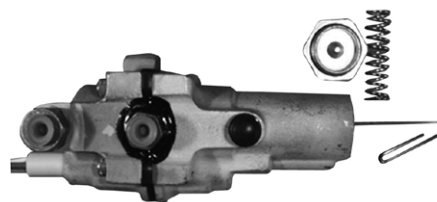



Diagnosticando la válvula RWAL

2a. Generación

1. Retire el cubrepolvo.
2. Aplique el freno y revise que no se mueva el pistón de la válvula.

Lo que usted debe saber cuando reemplace un CAS:

1. Programar el tipo de eje y la medida de la llanta.
2. Programar el VIN. Esta programación se debe realizar vía electrónica (escáner).
3. Para tener una exitosa programación en la memoria del CAS siga las instrucciones del escáner.

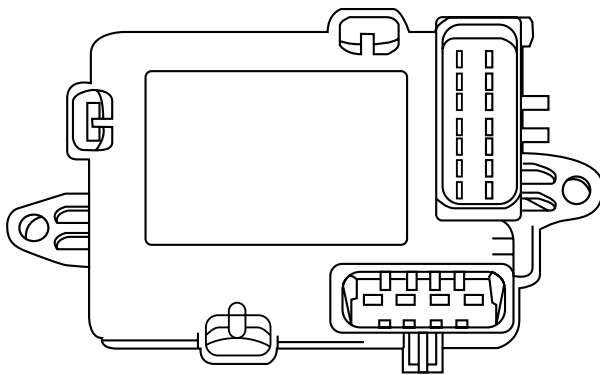
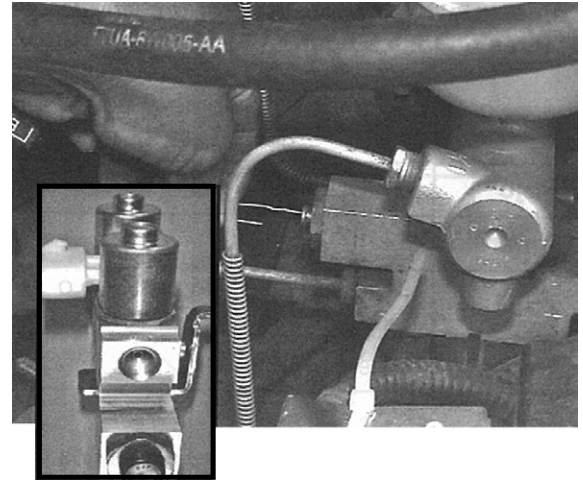

Sistema RWAL

El diseño de este sistema es de un sólo canal (frenos traseros). Al igual que los demás sistemas, utiliza un CAS que es un microprocesador que monitorea la correcta operación del sistema realizando una autopruueba de diagnóstico.

Al diagnosticar los componentes del ABS es necesario que contemos con un multímetro digital y un escáner.



Resistencia (Ω)



Voltaje (V)

De acuerdo al tipo de sensor de velocidad se genera una señal:

1. Análoga: 0 a 5 volts CA (onda senoidal)
Resistencia: 900 a 17000+ -100
2. Digital: 0-12 volts CD (onda digital)

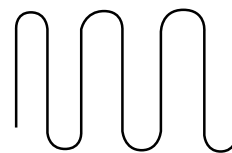

Señal análoga

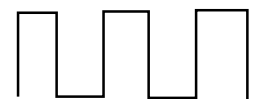

Señal digital

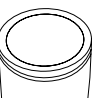



Cómo interpretar los diagramas eléctricos Colores de los cables

Los colores básicos de corriente y tierra son:

Rojo	+ 12 volts
Amarillo	+ 12volts
Azul	Circuito luces de posición o identificadores
Negro	Tierra

También encontramos los colores siguientes para los demás cables y conectores.

BA	Blanco	NO	Negro
BE	Azul	OR	Naranja
BJ	Beige	RG	Rojo
CY	Cristal o blanco	SA	Salmón
GR	Gris	VE	Verde
JA	Amarillo	V	Violeta
MA	Marrón		

Cómo comprobar las terminales

Un conector dañado o una conexión intermitente pueden resultar de una prueba inadecuada del conector durante las comprobaciones de circuitos.

Para comprobar el conector adecuadamente, utilice una punta en forma "T". Para un mejor contacto, sujete la punta "T" utilizando un caimán.

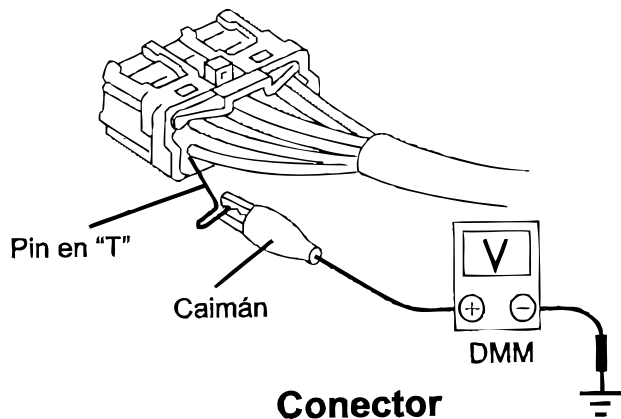

Comprobación del lado de la Terminal Terminal hembra

Hay una pequeña ranura sobre cada terminal hembra. Compruebe cada terminal con la punta en "T" a través de la ranura. No inserte ningún objeto en la terminal hembra, solamente que sea una terminal tipo macho.

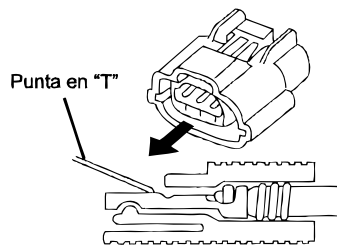

Terminal hembra

Algunos conectores no tienen una ranura sobre cada terminal. Para comprobar cada terminal, remueva el retén del conector para hacer contacto con la superficie.

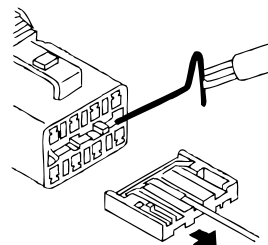

Seguro conector

Cómo comprobar la fatiga del muelle del contacto de la terminal

Un muelle de contacto fatigado en una terminal puede crear señales intermitentes en el circuito. Si se presenta un circuito abierto, realice el siguiente procedimiento para localizar los cables abiertos y los muelles de contacto fatigados en las terminales hembra.

1. Ensamble una terminal macho en un cable de aproximadamente 10 cm (3.9 pulg). Use una terminal macho que se acople a la terminal hembra.
2. Desconecte el extremo del arnés sospechoso de falla y mantenga su terminal hacia arriba.



Inspección de los sellos de hule

- La mayoría de los conectores impermeables se suministran con un sello de hule entre las terminales macho y hembra. Si falta el sello, el desempeño a prueba de agua puede no satisfacer las especificaciones.
- El sello de hule podría desprenderse cuando es desconectado el arnés. Siempre que éste se vuelva a conectar, asegúrese de que el sello de hule está instalado adecuadamente en cualquier lado de la terminal macho o hembra.

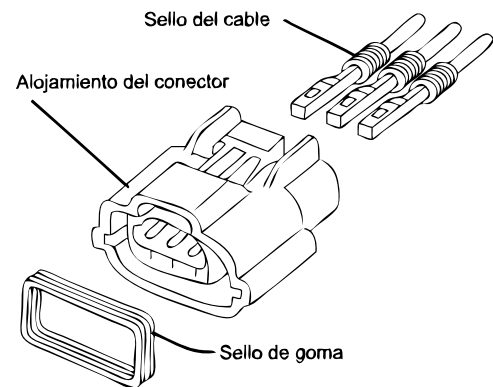

Conectores y cables eléctricos

- Determine que conectores y arnés de cableado afectan al sistema eléctrico que está inspeccionando.
- Suavemente agite cada conector y arnés mientras monitorea el sistema en busca del incidente que está tratando de reproducir. Esta prueba puede indicar que hay una conexión eléctrica suelta o mal hecha.

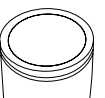
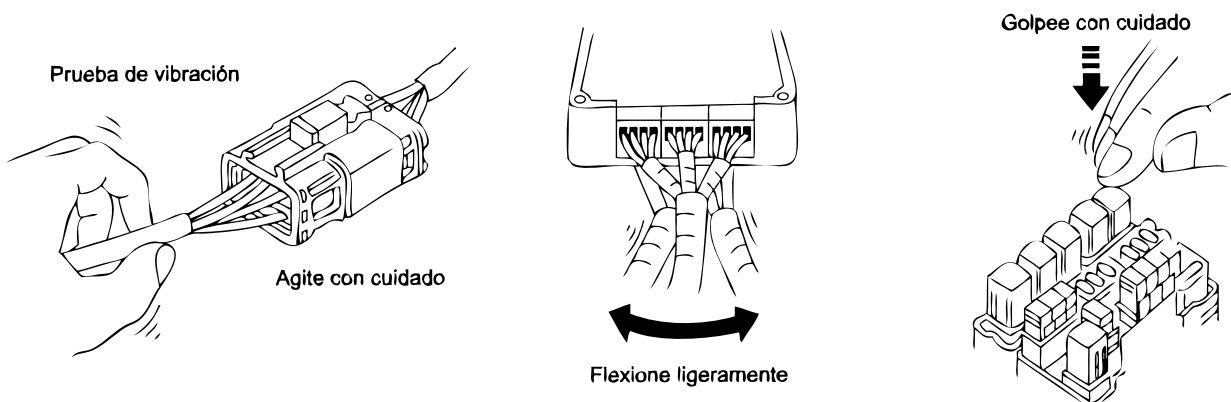



Compartimiento del motor

Hay varias razones de vibraciones en un vehículo o motor que pueden causar problemas eléctricos. Algunas de las cosas que hay que comprobar son:

- Los conectores no están bien ensamblados.
- El cable no es lo suficientemente largo y está sometido a esfuerzos causados por las vibraciones del motor o al balanceo.
- Cables que pasan por soportes o componentes móviles.
- Cables a tierra sucios, sueltos o corroídos.
- Cables instalados demasiado cerca de componentes calientes.

Inspección del circuito

- **ABIERTO:** un circuito está abierto cuando no hay continuidad a través de una sección del mismo.
- **CORTO:** existen dos tipos
Cortocircuito: cuando un circuito hace contacto con otro y provoca el cambio en la resistencia normal.
Corto a tierra: cuando un circuito hace contacto con un elemento conectado a tierra.

Método de comprobación de la continuidad

La comprobación de continuidad se emplea para encontrar el punto abierto del circuito. El multímetro digital ajustado en la función de resistencia, indicará un circuito abierto como sobre límite (no hay indicación acústica o lectura de ohm). Asegúrese de colocar el multímetro en el valor de resistencia más alto.

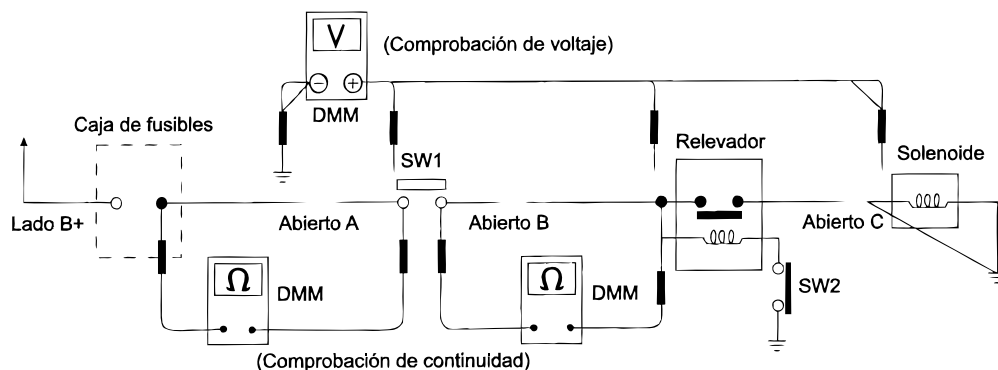



Método de comprobación de la resistencia

1. Desconecte la terminal negativa del acumulador y quite el fusible que se ha fundido.
2. Desconecte todas las cargas (SW1 abierto, relevador y solenoide desconectados) que están activadas a través del fusible.
3. Conecte una sonda del ohmetro a la terminal de carga del fusible y la otra a tierra.
4. Con SW1 abierto, compruebe la continuidad. “Continuidad: el corto está entre la terminal del fusible y SW1 (punto A)”. “No Continuidad: el corto está más adelante de SW1”.
5. Cierre SW1 y desconecte el relevador. Coloque las sondas en la terminal de carga del fusible y tierra. Luego, compruebe la continuidad. “Continuidad: el corto está entre SW1 y el relevador (punto B)”. “No Continuidad: el corto está más adelante del relevador”.
6. Cierre SW1 y haga un puente con un alambre entre los contactos del relevador. Coloque las sondas en la terminal de carga del fusible y tierra en buenas condiciones. Después compruebe la continuidad. “Continuidad: el corto se encuentra entre el relevador y el solenoide (Punto C)”. “No Continuidad: compruebe el solenoide y repita los pasos anteriores”.

Inspección de conexión a tierra

Las conexiones a tierra suelen estar expuestas a la humedad, el polvo y otros materiales corrosivos. La corrosión (oxidación) puede convertirse en una resistencia indeseada. Ésta puede cambiar la manera en que funciona un circuito.

Los circuitos controlados electrónicamente son muy sensibles a su conexión correcta a tierra. Una tierra suelta o deficiente puede afectar drásticamente a un circuito controlado electrónicamente.

La corrosión puede afectar fácilmente a un circuito.

Incluso cuando la conexión a tierra parece limpia puede existir una fina capa de óxido en su superficie.

Fallas de alta resistencia

Incluyen aberturas en el circuito y áreas donde las conexiones pueden estar flojas, sucias o corroídas y se pueden reflejar en lámparas que se atenúan, motores que trabajan lentamente o un dispositivo que no funciona.

Fallas de baja resistencia

Incluyen cortos circuitos y circuitos que tienen tierras no establecidas.

Síntomas:

- Fusible fundido
- Dispositivo sin funcionar
- Aislamiento quemado del cable
- Un circuito o componente que utiliza más corriente de la especificada

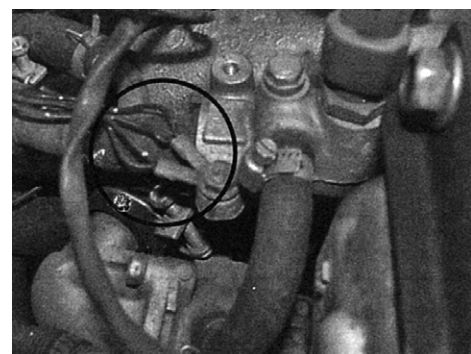

Terminal de tierra física

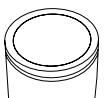



Relevadores

Los relevadores cumplen con las especificaciones de la Organización de Normas Internacionales con respecto al tamaño común y el patrón de la terminal. Se localizan en el centro de distribución de energía.

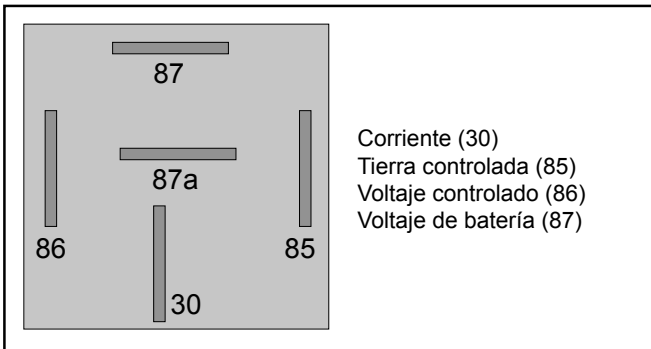

Relevador



Cables

El cable es el conductor que se usa en los sistemas eléctricos automotrices para completar el circuito entre los dispositivos eléctricos y la fuente de energía.

Todos los circuitos en los sistemas eléctricos de los vehículos están designados por una serie de letras y números.

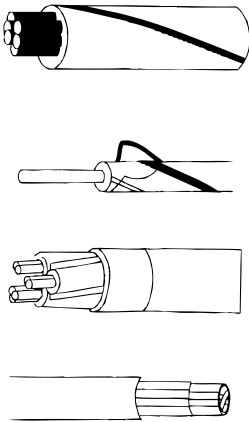

Diferentes tipos de cables

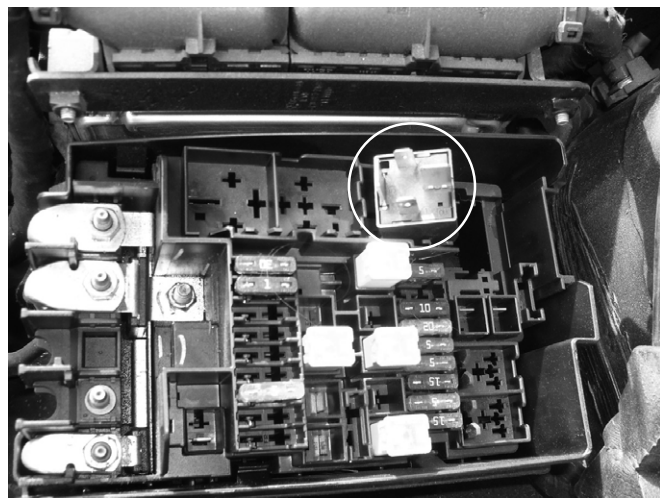

Relevadores de ABS

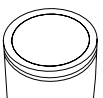



	Positivo		Conector
	Negativo		Conector macho
	Tierra		Conector hembra
	Fusible		Conector múltiple
	Disyuntor		Denota que el alambre continúa en otra parte
	Capacitor		Empalme
	Ohms		Identificación de empalme
	Resistor		Opcional [Alambrado con Alambrado sin
	Resistor variable		Elemento térmico (cinta bimetálica)
	Resistor en serie		Devanados en "Y"
	Bobina		Dispositivo de despliegue digital
	Bobina multiplicadora		Lámpara de filamento único
	Contacto abierto		Lámpara de filamento dual
	Contacto cerrado		L.E.D.- diodo emisor de luz
	Interruptor cerrado		Termistor
	Interruptor abierto		Indicador
	Interruptor múltiple cerrado		Cronomedidor
	Interruptor múltiple abierto		Motor
	Interruptor de dos polos y dirección única		Inducido y escobillas
	Interruptor de presión		Denota que el alambre atraviesa un aro de refuerzo
	Interruptor de solenoide		Denota que el alambre atraviesa un liberador de 40 vías
	Interruptor de mercurio		Denota que el alambre atraviesa un conector de columna de dirección de 25 vías
	Diodo o rectificador		Denota que el alambre atraviesa un conector de instrumentos de 25 vías
	Diodo zener bidireccional		

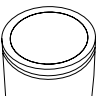



Leyendas de símbolos que se usan en diagramas de alambrado

Tamaño del cable

El uso de un cable de tamaño apropiado es crítico debido a que el flujo de corriente es sensible a los cambios de resistencia. Hay que considerar el número de calibre del cable y la longitud del mismo (1 m de cable = 1 W de resistencia).

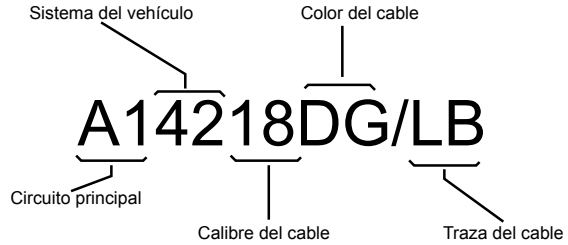

Cómo leer un diagrama

Los diagramas eléctricos se parecen a un mapa de caminos de circuitos eléctricos. Para “seguir” el flujo de electricidad a través de un circuito, comience a partir de la batería o fusible de alimentación.

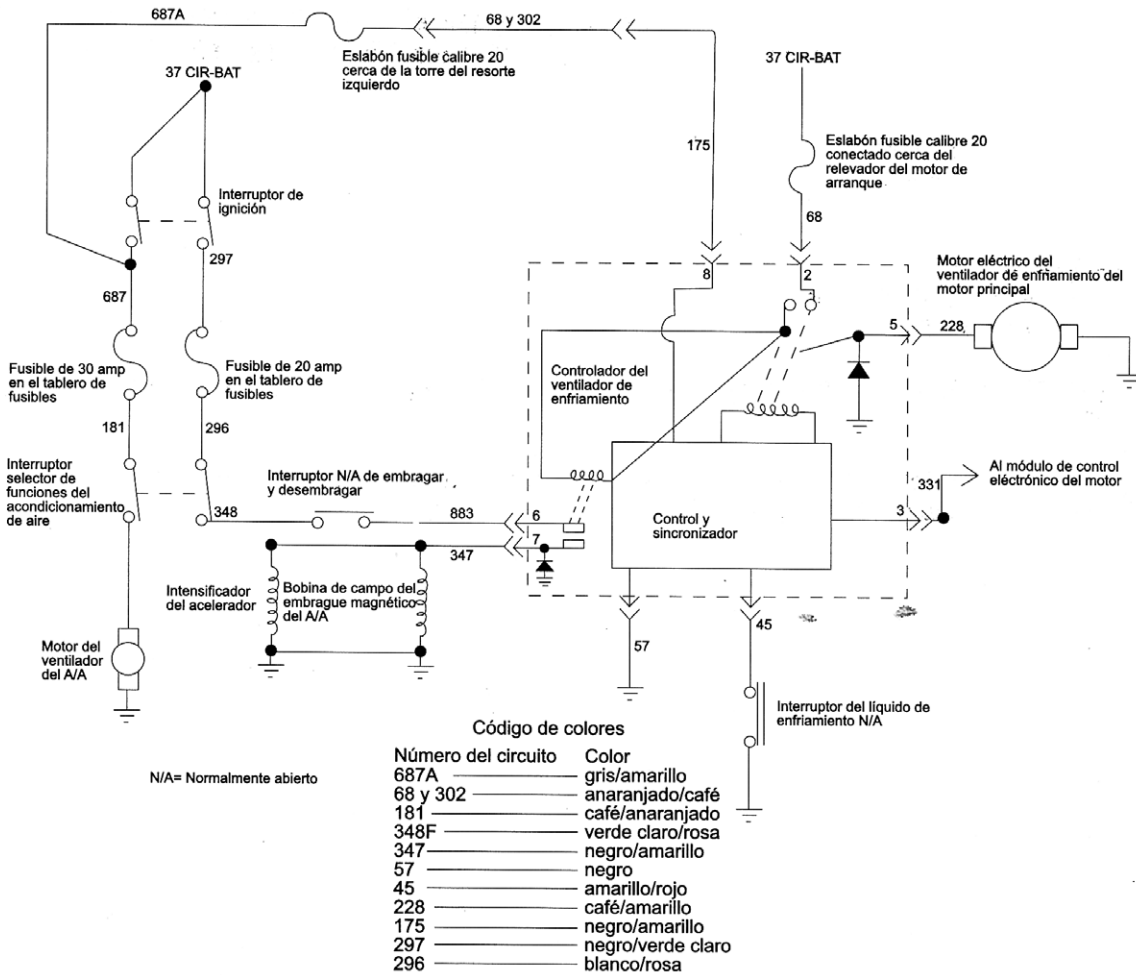

Diagrama de flujo de corriente

